



BAHCO



Tabela de Preços
2024

Catálogo - Tabela 2024

Catálogo - Tabela

Conteudo	2-9
Índice alfanumérico	665-745
Preço da soldadura	746
Condições gerais de venda	747
Garantia	751

12 FITA DE SERRA



21-36 LIMAS



37-60 CHAVES DE BOCAS



61-102 CHAVES DE CAIXA E ROQUETES



103-122 FERRAMENTAS DINAMOMÉTRICAS



123-186 ACESSÓRIOS PARA MÁQUINAS



BAHCO

187-220 CHAVES DE PARAFUSOS



221-230 CHAVES HEXAGONAIS OFFSET



231-264 ALICATES



265-272 CHAVES DE BOCAS PARA TUBOS E FERRAMENTAS PARA TUBAGENS



273-288 FERRAMENTAS PNEUMÁTICAS



289-294 FERRAMENTAS ELÉTRICAS SEM FIOS



471-490 FERRAMENTAS PARA TRABALHOS EM ALTURA



491-504 FERRAMENTAS ISOLADAS



505-524 FERRAMENTAS QUE NÃO PRODUZEM FAÍSCAS



525-530 FERRAMENTAS EM AÇO INOXIDÁVEL



531-536 FERRAMENTAS DE PRECISÃO E FERRAMENTAS ESPECIAIS PARA ELETRÔNICA



537-546 MEDIÇÃO E ORGANIZAÇÃO



547-554 FERRAMENTAS PARA PAREDES



555-558 LÂMINAS PARA SERROTE



559-568 SERROTES



569-574 FORMÕES PARA MADEIRA



575-586 TESOURAS E FACAS



587-590 BRAÇADEIRAS E TORNOS



591-598 MARTELOS



599-602 FERRAMENTAS PARA LIMPEZA DE FLORESTAS E SILVICULTURA



603-610 FORMÕES E PUNÇÕES



611-614 PÉS DE CABRA



615-618 FERRAMENTAS PARA PLANTAR E PODAR



619-638 FERRAMENTAS DE PODA



639-642 FERRAMENTAS PNEUMÁTICAS PARA EXTERIORES



643-666 LINDSTRÖM



Fita de Serra	11-20	Chaves de parafusos	187-220
SERRAS DE FITA BI-METAL PARA CORTE DE METAL	12	CHAVES DE PARAFUSOS ERGO™ COM PEGA DE BORRACHA E IDENTIFICAÇÃO POR CORES	188
SERRAS DE FITA TRI-METAL PARA CORTE DE METAL	15	CHAVES DE PARAFUSOS ERGO™ COM PEGA DE IMPACTO	198
SERRAS DE FITA DE CARBONETO PARA CORTE DE METAL	15	CHAVES DE PARAFUSOS BAHCOFIT COM PEGA DE BORRACHA TEXTURADA	200
CORTE DE MADEIRA	17	CHAVES DE PARAFUSOS COM PEGA EM BORRACHA	208
LÂMINAS ESPECIAIS PARA SERRAS DE FITA	17	CHAVES PARA PARAFUSOS COM PUNHO DE ROQUETE	211
LÂMINAS DE SERRA CIRCULAR HSS	17	CHAVES DE PARAFUSOS DE PRECISÃO	212
LÂMINAS PARA SERROTES MECÂNICOS	18	CHAVES DE PARAFUSOS COM PEGA EM T	215
ACESSÓRIOS PARA SERRAS DE FITA	20	CHAVES DE PARAFUSOS COM SUPORTES DE BITS DE 1/4"	216
		CHAVES DE PARAFUSOS COM PEGA DE MADEIRA OU PLÁSTICO	217
		FERRAMENTAS DE TESTE ELÉTRICAS	219
		ACESSÓRIOS	219
Limas	21-36	chaves hexagonais Offset	221-230
LIMAS DE ENGENHARIA	22	PONTAS SEXTAVADAS	222
LIMAS DE AFIAR	26	PONTAS TORX	226
GROSAS	30	LUNETAS DUPLAS	229
LIMAS DE DENTES FRESADOS	31	MULTIFERRAMENTAS	229
LIMAS DE AGULHAS	31		
LIMAS DE DIAMANTE	34	Alicates	231-264
ACESSÓRIOS	35	ALICATES DE CORTE	232
		ALICATES UNIVERSAIS	239
		ALICATES DE PREENSÃO	241
		ALICATES DE BOMBAS DE ÁGUA	247
		ALICATE PARA FREIOS	249
		DESCARNADORES E FERRAMENTAS DE DESMONTAGEM	251
		ALICATES DE CRAVAR	254
		CONJUNTOS DE ALICATES	257
		ALICATES DE PREENSÃO	259
		FERRAMENTAS PARA REBITAR	263
		ALICATES ESPECIAIS	264
		Chaves de bocas para tubos e ferramentas para tubagens	265-272
		CHAVES DE BOCAS PARA TUBOS	266
		FERRAMENTAS PARA CORTE DE TUBOS	268
		FERRAMENTAS PARA DOBRAR E MOLDAR	270
		FERRAMENTAS PARA REBARBAR	271
		Ferramentas pneumáticas	273-288
		PISTOLAS DE IMPACTO	274
		ROQUETES	277
		REBARBADORAS, LIXADEIRAS E POLIDORES	277
		BROCAS E CHAVES DE PARAFUSOS	282
		FERRAMENTAS DE CORTE	283
		MARTELOS, REBITADORES E MARCADORES	284
		PISTOLAS DE PINTURA	285
		SOPRADORES E FERRAMENTAS DE LIMPEZA	286
		ACESSÓRIOS E EQUIPAMENTOS PARA FERRAMENTAS PNEUMÁTICAS	286
		Ferramentas elétricas sem fios	289-294
		PISTOLAS DE IMPACTO	290
		ROQUETES	290
		BROCAS E CHAVES DE PARAFUSOS	291
		REBARBADORAS, LIXADEIRAS E POLIDORES	292
		FERRAMENTAS DE CORTE	292
		MASSAS LUBRIFICANTES	293
		BATERIAS E CARREGADORES	293
Chaves de bocas	37-60		
CHAVES AJUSTÁVEIS	38		
CHAVES DE BOCAS COMBINADAS	40		
CHAVES DE ROQUETE	45		
CHAVES DE BOCAS ABERTAS	48		
CHAVE DE LUNETAS	52		
CHAVE DE LUNETAS ABERTA	54		
CHAVES DE BOCAS	55		
CHAVES DE CAIXA	56		
CHAVES MULTIFUNÇÕES	59		
CHAVES DE BOCAS DE GANCHO	60		
Chaves de caixa e roquetes	61-102		
CONJUNTOS DE CHAVES DE CAIXA	62		
1/4"	78		
3/8"	85		
1/2"	91		
3/4"	98		
1"	101		
ESTOJOS VAZIOS PARA CONJUNTOS DE CHAVES DE CAIXA	102		
CHAVES DE CAIXA			
CHAVES DE BOCAS PARA ANDAIMES	102		
Ferramentas dinamométricas	103-122		
CHAVES DE BOCAS DINAMOMÉTRICAS DIGITAIS	104		
CHAVES DINAMOMÉTRICAS MECÂNICAS	106		
CHAVES DE PARAFUSOS DINAMOMÉTRICAS	111		
MULTIPLICADORES	113		
FERRAMENTAS DE TESTE DE BINÁRIO	114		
ADAPTADORES DE BINÁRIO E ÂNGULO	115		
FERRAMENTAS DE ELEMENTOS DE INSERÇÃO	115		
ESTOJOS VAZIOS PARA FERRAMENTAS DE TORQUE	121		
Acessórios para Máquinas	123-186		
SERRAS CRANIANAS	124		
LÂMINAS PARA SERRAS SABRE	134		
LÂMINAS TICO-TICO	138		
ACESSÓRIOS MULTI-FERRAMENTAS	139		
LÂMINAS PARA SERRAS CIRCULARES	141		
DISCOS ABRASIVOS PARA CORTE	142		
LÂMINAS DE SERRA DE FITA	143		
LIMAS ROTATIVAS "CARBIDE"	144		
BROCAS	148		
BITS PARA CHAVES DE PARAFUSOS	156		
CHAVES DE IMPACTO DE	172		



Ferramentas para automóveis 295-356

FERRAMENTAS PARA MOTORES	296
FERRAMENTAS PARA ESCAPES	318
FERRAMENTAS E EQUIPAMENTOS PARA MUDANÇAS DE ÓLEO	319
FERRAMENTAS E EQUIPAMENTOS PARA O SISTEMA DE TRAVAGEM	324
FERRAMENTAS PARA DIREÇÃO E JANTES	328
FERRAMENTAS E EQUIPAMENTOS PARA SUSPENSÕES	336
FERRAMENTAS PARA GESTÃO DE BATERIAS ELÉTRICAS	337
PRENSAS E ACESSÓRIOS	341
EQUIPAMENTO PARA ILUMINAÇÃO	342
FERRAMENTAS PARA OFICINAS DE CHAPEIRO	344
EQUIPAMENTO DE ELEVAÇÃO	349

Equipamento de iluminação 357-358

LANTERNAS	358
LUZES PARA A CABEÇA	358
ENROLADORES DE CABO	358

Ferramentas de inspeção 359-362

ENDOSCÓPIOS	360
ESTETOSCÓPIOS	360
ESPELHOS	360
LUPAS	361

Extratores e puxadores 363-372

MECÂNICOS	364
PÉS DE CABRA	370
FERRAMENTAS PARA "PICK-UP"	371
FERRAMENTAS PARA ROSCAS	371

Arrumação e kits de ferramentas 373-470

CARRINHOS DE FERRAMENTAS	374
ESTOJOS RÍGIDOS	436
ARMÁRIOS E PAINÉIS	448
CAIXAS DE FERRAMENTAS METÁLICAS	456
CAIXAS E ESTOJOS DE PLÁSTICO	462
EQUIPAMENTOS DE TÊXTEIS E CABEDAL	463

Ferramentas para trabalhos em altura 471-490

ARRUMAÇÃO E FITAS PARA FERRAMENTAS	472
CHAVES DE BOCAS	475
CHAVES DE BOCAS PARA TUBOS	477
CHAVES DE CAIXA E ROQUETES	477
CHAVES DE PARAFUSOS	480
ALICATES	482
FERRAMENTAS DE CORTE	484
MARTELOS, PÉS DE CABRA E FORMÕES	486
MEDIÇÃO E ORGANIZAÇÃO	488
FERRAMENTAS DINAMOMÉTRICAS	489
GRAMPOS	489
OUTRAS FERRAMENTAS	489
LUVAS	490

Ferramentas isoladas 491-504

CHAVES DE PARAFUSOS	492
ALICATES	498
CHAVES DE BOCAS	501
ROQUETES E CHAVES DE CAIXA ISOLADAS	502
TESOURAS E FACAS	502
FERRAMENTAS DE PRECISÃO	503
EQUIPAMENTO DE PROTEÇÃO	503
CONJUNTOS DE FERRAMENTAS	503

Ferramentas que não produzem faíscas 505-524

CHAVES DE BOCAS	506
CHAVES DE BOCAS PARA TUBOS E FERRAMENTAS PARA VÁLVULAS	511
CHAVES DE CAIXA E ROQUETES	512
CHAVES DE PARAFUSOS	515
ALICATES	516
MARTELOS, PÉS DE CABRA E FORMÕES	518
RASPADORES	521
FERRAMENTAS PARA SOLO	523
EXTRATORES E PUXADORES	523
FERRAMENTAS DINAMOMÉTRICAS	524

Ferramentas em aço inoxidável 525-530

CHAVES DE BOCAS	526
CHAVES DE CAIXA E ROQUETES	527
CHAVES DE PARAFUSOS	528
CHAVES HEXAGONAIS OFFSET	528
BITS PARA CHAVES DE PARAFUSOS	529
ALICATES	529
MARTELOS	530
PUNÇÕES E FORMÕES	530

Ferramentas de precisão e ferramentas especiais para eletrônica 531-536

FERRAMENTAS DE PRECISÃO	532
FERRAMENTAS DE SOLDAR	535
MEÂNICA DE PRECISÃO	535

Medição e organização 537-546

FITAS MÉTRICAS	538
RODAS DE MEDIÇÃO	539
NÍVEIS DE BOLHA	539
MARCAÇÃO	542
RÉGUAS	543
ESQUADROS	544
MEDIÇÃO DE PRECISÃO	545

Ferramentas para paredes 547-554

RASPADORES	548
FERRAMENTAS PARA ALVENARIA	550
FERRAMENTAS PARA GESSO CARTONADO	552

Lâminas para serrote 555-558

ARMAÇÃO DE SERROTE	556
ARMAÇÃO DE SERROTE	557

Serrotos 559-568

SERROTOS PARA MATERIAL DE CONSTRUÇÃO	560
SERROTOS PARA MADEIRA	561
SERRAS MANUAIS DE PRECISÃO	565
PUNHOS E AMOLADORES	566
SERRAS DE RECORTES E LÂMINAS PARA SERRAS	566
SERRAS E LÂMINAS PARA SERRAS	567
SERROTE MUSICAL	567

Formões para madeira 569-574

FORMÕES DE MARCENARIA	570
GOIVAS	572
FORMÕES DE DEMOLIÇÃO	572
ACESSÓRIOS PARA FORMÕES DE MADEIRA	573

Tesouras e facas 575-586

TESOURAS PARA METAL	576
TESOURAS	579
FACAS	580

Braçadeiras e tornos 587-590

BRAÇADEIRAS	588
TORNOS DE BANCADA	589
ACESSÓRIOS PARA TORNOS DE BANCADA	590

Martelos 591-598

MARTELOS DE ORELHAS	592
EXTRATORES DE PREGOS	593
MARTELOS DE ENGENHARIA	593
MARTELOS DE CONSTRUÇÃO	594
MARTELOS ESPECIAIS	596
MAÇOS	596
MARTELOS DE FACE MACIA	597

Ferramentas para limpeza de florestas e silvicultura 599-602

MACHADOS E MARTELOS FLORESTAIS	600
CUNHAS	601

Formões e punções 603-610

FORMÕES	604
FORMÕES COM RESGUARDO	605
FORMÕES, RETIFICÁVEIS	605
ACESSÓRIOS PARA CINZELS FRIOS	606
PUNÇÕES	606
PUNÇÕES COM PUNHO DE 2 PEÇAS	610
FORMÕES COM PUNHOS DE 2 PEÇAS	610

Pés de cabra 611-614

BARRAS DE DEMOLIÇÃO	612
---------------------	-----

Ferramentas para plantar e podar 615-618

FERRAMENTAS DE JARDIM PEQUENAS	616
--------------------------------	-----

Ferramentas de poda 619-638

TESOURAS DE PODAR	620
FERRAMENTAS PARA A APANHA DE FRUTOS	624
TESOURÕES	624
VARAS TELESCÓPICAS E TESOURAS DE PODA NO AR	626
TESOURAS DE SEBES	630
TESOURAS PARA RELVA	631
FACAS PARA PODA	632
TESOURAS	632
SERROTE DE ARCO	633
SERROTES DE PODA	634
PEÇAS SOBRESSELENTES E ACESSÓRIOS	636
ACESSÓRIOS E MANUTENÇÃO	636

Ferramentas pneumáticas para exteriores 639-642

TESOURAS DE PODAR	640
-------------------	-----

Lindström 643-666**Cortadores de precisão**

CORTADORES DIAGONAIS	644
CORTADORES DIAGONAIS, CABEÇA ÚNICA	645
OBLÍQUO - CORTADORES FINAIS	645
ÂNGULO	646
CORTADORES DE PLÁSTICO	647
CORTADOR DE PONTA	648
CORTADORES OBLÍQUOS, CABEÇA ÚNICA	648
MICRO TIP CUTTERS	648
TESOURAS MULTIUSO	648
ACESSÓRIOS E PEÇAS DE REPOSIÇÃO	649

Cortadores de Precisão para Materiais Duros

CORTADORES DE CARBONETO	649
CORTADORES DIAGONAIS EXTRA ENDURECIDOS	649
CORTADORES DIAGONAIS ESPECÍFICOS DO DESEMPENHO	649
CORTADORES DIAGONAIS ESPECÍFICOS DE DESEMPENHO, CABEÇA ÚNICA	650

Alicate de Fixação de Precisão

NARIZ ACHATADO	650
NARIZ REDONDO	650
NARIZ DE CADEIA	651
ALICATE DE MALHA METÁLICA	651
NARIZ DOBRADO	651
NARIZ SNIPE	651
NARIZ DE SNIPE, CABEÇA ÚNICA	652
NARIZ DE AGULHA	652

Cortadores Especiais

FERRAMENTAS DE INSERÇÃO / EXTRAÇÃO E CORTADORES DE IC	652
CORTE E BENDER	652
CORTADORES DE IMPASSE	653
CORTE E FORMA	653
LEADFORMERS	653

Alicates Especiais

FERRAMENTAS DE INSERÇÃO / EXTRAÇÃO E CORTADORES DE IC	654
LEADFORMERS	654

Alicates Precisão

ALICATES CABEÇA CÓNICA	652
CABEÇA PONTIAGUDA	653
ALICATE DE CABEÇA OBLÍQUA	653

Chaves de fenda de precisão

SEGURANÇA ESD	653
---------------	-----

Descascadores de fios

CORTADORES DIAGONAIS	654
----------------------	-----

Alicates de corte para trabalhos pesados

CORTADOR DIAGONAL	654
-------------------	-----

Ferramentas de Torque

CHAVES DE FENDA DE TORQUE	654
---------------------------	-----

Pinças

CONJUNTOS DE PINÇA	655
PINÇAS DE CORTE	656
PINÇA DE ALTA PRECISÃO	656
PINÇAS DE PLÁSTICO COM PONTA SUBSTITUÍVEL - FIBRA DE CARBONO	658
PINÇAS TÁCTEIS ERGONÓMICAS COM SEGURANÇA ESD	658
PINÇAS ECONÓMICAS	659
PINÇAS SMD	660
COMPONENTES PINÇAS DE POSICIONAMENTO	662
PINÇA GERAL DE PROPÓSITO	662
ACESSÓRIOS E PEÇAS SOBRESSELENTES	662



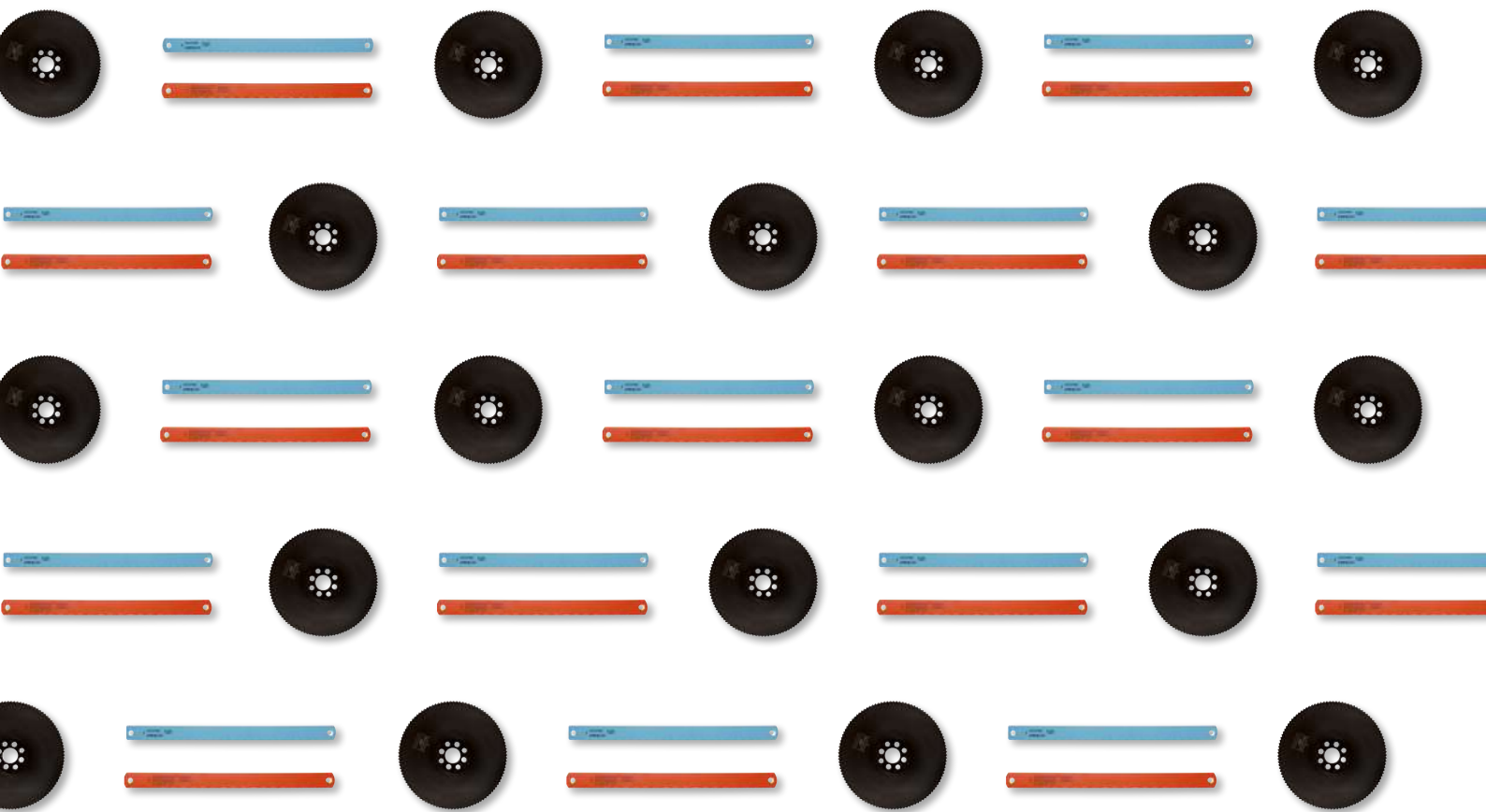

Fita de Serra



SERRAS DE FITA BI-METAL PARA CORTE DE METAL

Lâmina de serra de fita universal para oficinas pequenas



3857 Easy-Cut

		€		
13 mm	EZ	9,81	1	3857-13-0.6-EZ-S
13 mm	EZ	9,81	1	3857-13-0.6-EZ-M
13 mm	EZ	9,81	1	3857-13-0.6-EZ-L
20 mm	EZ	10,91	1	3857-20-0.9-EZ-S
20 mm	EZ	10,91	1	3857-20-0.9-EZ-M
20 mm	EZ	10,91	1	3857-20-0.9-EZ-L
27 mm	EZ	12,43	1	3857-27-0.9-EZ-S
27 mm	EZ	12,43	1	3857-27-0.9-EZ-M
27 mm	EZ	12,43	1	3857-27-0.9-EZ-L
34 mm	EZ	15,26	1	3857-34-1.1-EZ-S
34 mm	EZ	15,26	1	3857-34-1.1-EZ-M
34 mm	EZ	15,26	1	3857-34-1.1-EZ-L

SANDFLEX Cobra

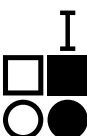

3851 Contour and small machine

		€		
6 mm	PRX	8,66	1	3851-6-0.6-10/14
6 mm	Hook	8,66	1	3851-6-0.6-H-6
6 mm	PRX	8,66	1	3851-6-0.9-10/14
6 mm	Hook	8,66	1	3851-6-0.9-H-6
10 mm	PRX	8,98	1	3851-10-0.6-10/14
10 mm	Hook	8,98	1	3851-10-0.6-H-4
10 mm	Hook	8,98	1	3851-10-0.6-H-6
10 mm	PRX	8,98	1	3851-10-0.9-10/14
10 mm	Hook	8,98	1	3851-10-0.9-H-4
10 mm	Hook	8,98	1	3851-10-0.9-H-6
10 mm	Regular	8,98	1	3851-10-0.9-R-14
13 mm	PRX	8,98	1	3851-13-0.5-10/14

		€		
13 mm	PRX	8,98	1	3851-13-0.5-14/18
13 mm	Regular	8,98	1	3851-13-0.5-R-10
13 mm	Regular	8,98	1	3851-13-0.5-R-14
13 mm	Regular	8,98	1	3851-13-0.5-R-18
13 mm	Regular	8,98	1	3851-13-0.5-R-24
13 mm	Hook	8,98	1	3851-13-0.5-H-4
13 mm	PRX	8,98	1	3851-13-0.6-10/14
13 mm	PRX	8,98	1	3851-13-0.6-5/8
13 mm	PRX	8,98	1	3851-13-0.6-6/10
13 mm	PRX	8,98	1	3851-13-0.6-8/12
13 mm	Hook	8,98	1	3851-13-0.6-H-3
13 mm	Hook	8,98	1	3851-13-0.6-H-4
13 mm	Hook	8,98	1	3851-13-0.6-H-6
13 mm	Regular	8,98	1	3851-13-0.6-R-10
13 mm	Regular	8,98	1	3851-13-0.6-R-14
13 mm	Regular	8,98	1	3851-13-0.6-R-18
13 mm	PRX	8,98	1	3851-13-0.9-10/14
13 mm	PRX	8,98	1	3851-13-0.9-6/10
13 mm	Hook	8,98	1	3851-13-0.9-H-3
13 mm	Hook	8,98	1	3851-13-0.9-H-4
13 mm	Hook	8,98	1	3851-13-0.9-H-6
13 mm	Regular	8,98	1	3851-13-0.9-R-14
13 mm	Regular	8,98	1	3851-13-0.9-R-6
20 mm	PRX	9,15	1	3851-20-0.9-10/14
20 mm	Hook	9,15	1	3851-20-0.9-H-3
20 mm	Hook	9,15	1	3851-20-0.9-H-4
20 mm	Regular	9,15	1	3851-20-0.9-R-18
20 mm	PRX	9,15	1	3851-20-0.9-4/6
20 mm	PRX	9,15	1	3851-20-0.9-5/8
20 mm	PRX	9,15	1	3851-20-0.9-6/10
20 mm	PRX	9,15	1	3851-20-0.9-8/12
27 mm	PS	9,30	1	3851-27-0.9-P-3
27 mm	PS	9,30	1	3851-27-0.9-P-4
27 mm	Regular	9,30	1	3851-27-0.9-R-6
34 mm	PS	13,67	1	3851-34-1.1-P-2
34 mm	PS	13,67	1	3851-34-1.1-P-3

Lâmina de fita de serra para fundição



3851 Sandflex® Cobra™ Foundry

		€		
10 mm	HA	8,98	1	3851-10-0.6-HA-4
13 mm	HA	8,98	1	3851-13-0.6-HA-4
13 mm	HA	8,98	1	3851-13-0.6-HA-6
13 mm	HA	8,98	1	3851-13-0.9-HA-4
20 mm	HA	9,15	1	3851-20-0.9-HA-3
20 mm	HA	9,15	1	3851-20-0.9-HA-4
27 mm	HA	9,30	1	3851-27-0.9-HA-4
27 mm	HA	9,30	1	3851-27-0.9-HA-3

Lâmina de fita de serra versátil e primeira escolha para corte de produção.



3851 Sandflex® Cobra™

mm	Tip	€	Icon 1	Icon 2	Code
27 mm	PRX	9,30	1		3851-27-0.9-2/3
27 mm	PRX	9,30	1		3851-27-0.9-3/4
27 mm	PRX	9,30	1		3851-27-0.9-4/6
27 mm	PRX	9,30	1		3851-27-0.9-5/8
27 mm	PRX	9,30	1		3851-27-0.9-6/10
27 mm	PRX	9,30	1		3851-27-0.9-8/12
27 mm	PRX	9,30	1		3851-27-0.9-10/14
34 mm	PRX	13,67	1		3851-34-1.1-2/3
34 mm	PRX	13,67	1		3851-34-1.1-3/4
34 mm	PRX	13,67	1		3851-34-1.1-4/6
34 mm	PRX	13,67	1		3851-34-1.1-5/8
34 mm	PRX	13,67	1		3851-34-1.1-6/10
41 mm	PRX	17,71	1		3851-41-1.3-1.4/2
41 mm	PRX	17,71	1		3851-41-1.3-2/3
41 mm	PRX	17,71	1		3851-41-1.3-3/4
41 mm	PRX	17,71	1		3851-41-1.3-4/6
41 mm	PRX	17,71	1		3851-41-1.3-5/8
54 mm	PRX	20,23	1		3851-54-1.3-1.4/2
54 mm	PRX	20,25	1		3851-54-1.3-2/3
54 mm	PRX	22,73	1		3851-54-1.3-3/4
54 mm	PRX	20,25	1		3851-54-1.3-4/6
54 mm	PR	20,25	1		3851-54-1.6-P-1.25
54 mm	PRX	20,25	1		3851-54-1.6-1/1.4
54 mm	PRX	20,25	1		3851-54-1.6-1.4/2
54 mm	PRX	20,25	1		3851-54-1.6-2/3
54 mm	PRX	20,25	1		3851-54-1.6-3/4
54 mm	PRX	20,25	1		3851-54-1.6-4/6
67 mm	PRX	35,08	1		3851-67-1.6-7/1
67 mm	PRX	35,08	1		3851-67-1.6-1/1.4
67 mm	PRX	35,08	1		3851-67-1.6-1.4/2
67 mm	PRX	35,08	1		3851-67-1.6-2/3
67 mm	PRX	35,08	1		3851-67-1.6-3/4
67 mm	PRX	35,08	1		3851-67-1.6-4/6
80 mm	PRX	52,69	1		3851-80-1.6-7/1
80 mm	PRX	52,69	1		3851-80-1.6-1/1.4
80 mm	PRX	52,69	1		3851-80-1.6-1.4/2

Lâmina de serra de fita única concebida para aços de ferramentas e materiais mais duros

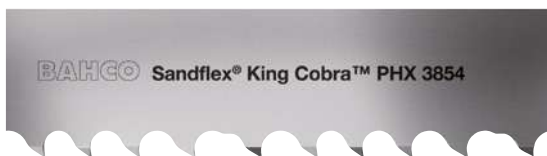

3854-Sandflex® King Cobra™ PHX

mm	Tip	€	Icon 1	Icon 2	Code
27 mm	PHX	10,45	1		3854-27-0.9-PHX-2/3
27 mm	PHX	10,45	1		3854-27-0.9-PHX-3/4
27 mm	PHX	10,45	1		3854-27-0.9-PHX-4/6

mm	Tip	€	Icon 1	Icon 2	Code
34 mm	PHX	14,63	1		3854-34-1.1-PHX-1.4/2
34 mm	PHX	14,63	1		3854-34-1.1-PHX-2/3
34 mm	PHX	14,63	1		3854-34-1.1-PHX-3/4
34 mm	PHX	14,63	1		3854-34-1.1-PHX-4/6
41 mm	PHX	18,95	1		3854-41-1.3-PHX-1.4/2
41 mm	PHX	18,95	1		3854-41-1.3-PHX-2/3
41 mm	PHX	18,95	1		3854-41-1.3-PHX-3/4
41 mm	PHX	18,95	1		3854-41-1.3-PHX-4/6
54 mm	PHX	26,39	1		3854-54-1.3-PHX-1.4/2
54 mm	PHX	26,39	1		3854-54-1.3-PHX-2/3
54 mm	PHX	26,39	1		3854-54-1.3-PHX-3/4
54 mm	PHX	29,89	1		3854-54-1.6-PHX-7/1
54 mm	PHX	29,89	1		3854-54-1.6-PHX-1/1.4
54 mm	PHX	29,89	1		3854-54-1.6-PHX-1.4/2
54 mm	PHX	29,89	1		3854-54-1.6-PHX-2/3
54 mm	PHX	29,89	1		3854-54-1.6-PHX-3/4
67 mm	PHX	37,54	1		3854-67-1.6-PHX-7/1
67 mm	PHX	37,54	1		3854-67-1.6-PHX-1/1.4
67 mm	PHX	37,54	1		3854-67-1.6-PHX-1.4/2
67 mm	PHX	37,54	1		3854-67-1.6-PHX-2/3
80 mm	PHX	56,38	1		3854-80-1.6-PHX-7/1
80 mm	PHX	56,38	1		3854-80-1.6-PHX-1/1.4
80 mm	PHX	56,38	1		3854-80-1.6-PHX-1.4/2

Lâmina para fita de serra eficiente para aço inoxidável e outros materiais resistentes



3854-Sandflex® King Cobra™ PQ

mm	Tip	€	Icon 1	Icon 2	Code
27 mm	PQ	14,57	1		3854-27-0.9-PQ-3/4
27 mm	PQ	14,57	1		3854-27-0.9-PQ-4/6
34 mm	PQ	16,59	1		3854-34-1.1-PQ-2/3
34 mm	PQ	16,59	1		3854-34-1.1-PQ-3/4
34 mm	PQ	16,59	1		3854-34-1.1-PQ-4/6
41 mm	PQ	19,75	1		3854-41-1.3-PQ-1.4/2
41 mm	PQ	19,75	1		3854-41-1.3-PQ-2/3
41 mm	PQ	19,75	1		3854-41-1.3-PQ-3/4
41 mm	PQ	19,75	1		3854-41-1.3-PQ-4/6
54 mm	PQ	30,14	1		3854-54-1.6-PQ-9/1.2
54 mm	PQ	30,14	1		3854-54-1.6-PQ-1.4/2
54 mm	PQ	30,14	1		3854-54-1.6-PQ-2/3
54 mm	PQ	30,14	1		3854-54-1.6-PQ-3/4
54 mm	PQ	30,14	1		3854-54-1.6-PQ-4/6
67 mm	PQ	39,13	1		3854-67-1.6-PQ-9/1.2
67 mm	PQ	39,13	1		3854-67-1.6-PQ-1.4/2
67 mm	PQ	39,13	1		3854-67-1.6-PQ-2/3
80 mm	PQ	57,86	1		3854-80-1.6-PQ-9/1.2
80 mm	PQ	56,38	1		3854-80-1.6-PQ-1.4/2



Lâmina de serra de fita eficiente para aço inoxidável e materiais resistentes para uma melhor vida útil da lâmina



3858 PQ P9000

		€		
41 mm	PQ	25,63	1	3858-41-1.3-PQ-1.4/2
41 mm	PQ	25,63	1	3858-41-1.3-PQ-2/3
41 mm	PQ	25,63	1	3858-41-1.3-PQ-3/4
54 mm	PQ	39,06	1	3858-54-1.6-PQ-9/1.2
54 mm	PQ	39,06	1	3858-54-1.6-PQ-1.4/2
54 mm	PQ	39,06	1	3858-54-1.6-PQ-2/3
67 mm	PQ	51,26	1	3858-67-1.6-PQ-9/1.2
67 mm	PQ	51,26	1	3858-67-1.6-PQ-1.4/2
80 mm	PQ	73,24	1	3858-80-1.6-PQ-9/1.2

Lâmina de serra de fita única concebida para aços de ferramentas e materiais mais duros para uma melhor vida útil da lâmina

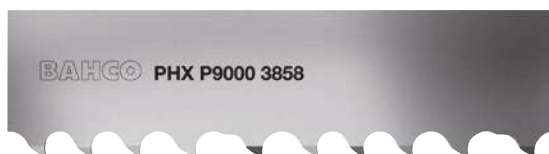

3858 PHX P9000

		€		
34 mm	PHX	15,50	1	3858-34-1.1-PHX-1.4/2
34 mm	PHX	15,50	1	3858-34-1.1-PHX-2/3
34 mm	PHX	15,50	1	3858-34-1.1-PHX-3/4
41 mm	PHX	20,75	1	3858-41-1.3-PHX-1.4/2
41 mm	PHX	20,75	1	3858-41-1.3-PHX-2/3
41 mm	PHX	20,75	1	3858-41-1.3-PHX-3/4
54 mm	PHX	26,85	1	3858-54-1.3-PHX-1.4/2
54 mm	PHX	26,85	1	3858-54-1.3-PHX-2/3
54 mm	PHX	26,85	1	3858-54-1.3-PHX-3/4
54 mm	PHX	26,85	1	3858-54-1.6-PHX-7/1
54 mm	PHX	26,85	1	3858-54-1.6-PHX-1/1.4
54 mm	PHX	26,85	1	3858-54-1.6-PHX-1.4/2
54 mm	PHX	26,85	1	3858-54-1.6-PHX-2/3
54 mm	PHX	26,85	1	3858-54-1.6-PHX-3/4
67 mm	PHX	36,62	1	3858-67-1.6-PHX-7/1
67 mm	PHX	36,62	1	3858-67-1.6-PHX-1/1.4
67 mm	PHX	36,62	1	3858-67-1.6-PHX-1.4/2
67 mm	PHX	36,62	1	3858-67-1.6-PHX-2/3
80 mm	PHX	43,21	1	3858-80-1.6-PHX-7/1
80 mm	PHX	43,21	1	3858-80-1.6-PHX-1/1.4
80 mm	PHX	43,21	1	3858-80-1.6-PHX-1.4/2

BAHCO

Lâmina de serra de fita especialmente concebida para perfis, tubos e conjuntos



3853 Sandflex® Top Fabricator

		€		
20 mm	PF	10,04	1	3853-20-0.9-5/7-VS
20 mm	PF	10,04	1	3853-20-0.9-8/11-VS
27 mm	PF	10,43	1	3853-27-0.9-3/4
27 mm	PF	10,43	1	3853-27-0.9-4/6
27 mm	PF	10,43	1	3853-27-0.9-5/8
27 mm	PF	10,43	1	3853-27-0.9-8/11-VS
27 mm	PF	10,43	1	3853-27-0.9-8/11-VS
34 mm	PF	12,91	1	3853-34-1.1-2/3
34 mm	PF	12,91	1	3853-34-1.1-3/4
34 mm	PF	12,91	1	3853-34-1.1-4/6
34 mm	PF	12,91	1	3853-34-1.1-5/8
34 mm	PF	12,91	1	3853-34-1.1-5/7-VS
34 mm	PF	12,91	1	3853-34-1.1-8/11-VS
41 mm	PF	20,00	1	3853-41-1.3-2/3
41 mm	PF-W	20,00	1	3853-41-1.3-2/3-W
41 mm	PF	20,00	1	3853-41-1.3-3/4
41 mm	PF-W	20,00	1	3853-41-1.3-3/4-W
41 mm	PF	20,00	1	3853-41-1.3-4/6
41 mm	PF	20,00	1	3853-41-1.3-5/8
41 mm	PF	20,00	1	3853-41-1.3-5/7-VS
54 mm	PF	24,56	1	3853-54-1.3-3/4
54 mm	PF	24,56	1	3853-54-1.3-3/4-W
54 mm	PF	24,56	1	3853-54-1.3-5/8
54 mm	PF	24,56	1	3853-54-1.6-2/3
54 mm	PF-W	24,56	1	3853-54-1.6-2/3-W
54 mm	PF	24,56	1	3853-54-1.6-3/4
54 mm	PF-W	24,56	1	3853-54-1.6-3/4-W
54 mm	PF	24,56	1	3853-54-1.6-4/6
67 mm	PF	34,90	1	3853-67-1.6-2/3
67 mm	PF-W	34,90	1	3853-67-1.6-2/3-W
67 mm	PF	34,90	1	3853-67-1.6-3/4
67 mm	PF-W	34,90	1	3853-67-1.6-3/4-W
67 mm	PF-W	34,90	1	3853-67-1.6-5/8-W

Lâmina de serra de fita bimetalica grande para corte de metais para ligas difíceis com dentes de aço rápido (HSS)



3853 Sandflex® Top Fabricator Coated

		€		
41 mm	PF	51,85	1	3853-41-1.3-2/3-WS
41 mm	PF	48,87	1	3853-41-1.3-3/4-WS
54 mm	PF	57,14	1	3853-54-1.6-2/3-WS
54 mm	PF	53,47	1	3853-54-1.6-3/4-WS
67 mm	PF	63,70	1	3853-67-1.6-2/3-WS
67 mm	PF	62,01	1	3853-67-1.6-3/4-WS

SERRAS DE FITA TRI-METAL PARA CORTE DE METAL

Serra de fita de carboneto Extreme Easy-Cut

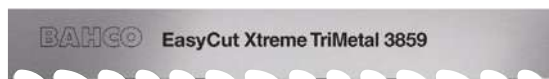

3859 Carbide Easy-Cut EZX

Altura	Modelo	€	Quantidade	Descrição
27 mm	EZX	32,14	1	3859-27-0.9-EZX-3/4
27 mm	EZX	42,02	1	3859-27-0.9-EZX-4/6
34 mm	EZX	31,72	1	3859-34-1.1-EZX-2/3
34 mm	EZX	40,38	1	3859-34-1.1-EZX-3/4
34 mm	EZX	43,67	1	3859-34-1.1-EZX-4/6
41 mm	EZX	30,39	1	3859-41-1.3-EZX-1.4/2
41 mm	EZX	34,30	1	3859-41-1.3-EZX-2/3
41 mm	EZX	44,19	1	3859-41-1.3-EZX-3/4
41 mm	EZX	46,25	1	3859-41-1.3-EZX-4/6
41 mm	EZX	43,16	1	3859-54-1.6-EZX-1.4/2
54 mm	EZX	39,24	1	3859-54-1.6-EZX-1/1.25
54 mm	EZX	44,70	1	3859-54-1.6-EZX-2/3
54 mm	EZX	48,00	1	3859-54-1.6-EZX-3/4
54 mm	EZX	56,75	1	3859-54-1.6-EZX-4/6
67 mm	EZX	39,45	1	3859-67-1.6-EZX-7/1
67 mm	EZX	46,66	1	3859-67-1.6-EZX-1.4/2
67 mm	EZX	42,75	1	3859-67-1.6-EZX-1/1.25
67 mm	EZX	57,17	1	3859-67-1.6-EZX-2/3
80 mm	EZX	41,51	1	3859-80-1.6-EZX-7/1
80 mm	EZX	49,23	1	3859-80-1.6-EZX-1.4/2
80 mm	EZX	77,25	1	3859-80-1.6-EZX-1/1.25

SERRAS DE FITA DE CARBONETO PARA CORTE DE METAL

Lâmina de fita de serra para fundição



3869 Carbide Triple Set®

Altura	Modelo	€	Quantidade	Descrição
13 mm	TS	53,99	1	3869-13-0.9-TS-3
20 mm	TS	55,83	1	3869-20-0.9-TS-3
20 mm	TS	81,45	1	3869-20-0.9-TS-4
27 mm	TS	55,83	1	3869-27-0.9-TS-3
27 mm	TS	81,45	1	3869-27-0.9-TS-4
34 mm	TS	35,27	1	3869-34-1.1-TS-2
34 mm	TS	59,49	1	3869-34-1.1-TS-3

Lâmina de fita de serra de carboneto versátil



3868 Carbide Triple Set® TSX

Altura	Modelo	€	Quantidade	Descrição
27 mm	TSX	87,49	1	3868-27-0.9-TSX-3/4
34 mm	TSX	57,33	1	3868-34-1.1-TSX-2
34 mm	TSX	69,82	1	3868-34-1.1-TSX-2/3
34 mm	TSX	86,09	1	3868-34-1.1-TSX-3/4
41 mm	TSX	70,50	1	3868-41-1.3-TSX-1.4/2
41 mm	TSX	61,27	1	3868-41-1.3-TSX-1.6
41 mm	TSX	60,20	1	3868-41-1.3-TSX-2
41 mm	TSX	74,87	1	3868-41-1.3-TSX-2/3
41 mm	TSX	92,13	1	3868-41-1.3-TSX-3/4
54 mm	TSX	91,48	1	3868-54-1.3-TSX-1.4/2
54 mm	TSX	93,01	1	3868-54-1.3-TSX-2/3
54 mm	TSX	93,16	1	3868-54-1.6-TSX-1/1.25
54 mm	TSX	101,86	1	3868-54-1.6-TSX-1.4/2
54 mm	TSX	88,57	1	3868-54-1.6-TSX-1.6
54 mm	TSX	93,28	1	3868-54-1.6-TSX-2/3
54 mm	TSX	93,28	1	3868-54-1.6-TSX-3/4
67 mm	TSX	122,43	1	3868-67-1.6-TSX-7/1
67 mm	TSX	127,43	1	3868-67-1.6-TSX-1/1.25
67 mm	TSX	130,30	1	3868-67-1.6-TSX-1.4/2
67 mm	TSX	130,30	1	3868-67-1.6-TSX-2/3
80 mm	TSX	205,05	1	3868-80-1.1-TSX-3/4
80 mm	TSX	130,30	1	3868-80-1.6-TSX-7/1
80 mm	TSX	139,15	1	3868-80-1.6-TSX-1/1.25
80 mm	TSX	129,40	1	3868-80-1.6-TSX-1.4/2
80 mm	TSX	180,64	1	3868-80-1.6-TSX-2/3

Conjunto Triplo Carbide "Xtra"

Lâmina de fita de serra de carboneto com ponta curvada versátil



3868 Carbide Triple Set® TSS

Altura	Modelo	€	Quantidade	Descrição
27 mm	TSS	87,49	1	3868-27-0.9-TSS-3/4
34 mm	TSS	71,21	1	3868-34-1.1-TSS-2/3
34 mm	TSS	8,81	1	3868-34-1.1-TSS-3/4
41 mm	TSS	77,62	1	3868-41-1.3-TSS-1.4/2
41 mm	TSS	76,80	1	3868-41-1.3-TSS-2/3
54 mm	TSS	113,99	1	3868-54-1.6-TSS-1/1.25
54 mm	TSS	111,95	1	3868-54-1.6-TSS-1.4/2
54 mm	TSS	118,10	1	3868-54-1.6-TSS-2/3
67 mm	TSS	122,43	1	3868-67-1.6-TSS-7/1
67 mm	TSS	130,30	1	3868-67-1.6-TSS-1/1.25
67 mm	TSS	130,30	1	3868-67-1.6-TSS-1.4/2
67 mm	TSS	130,30	1	3868-67-1.6-TSS-2/3
80 mm	TSS	130,30	1	3868-80-1.6-TSS-7/1
80 mm	TSS	156,23	1	3868-80-1.6-TSS-1.4/2
80 mm	TSS	180,64	1	3868-80-1.6-TSS-2/3



Lâmina de fita de serra de carboneto avançada



3881 Carbide Multi Set THQ

		€		
34 mm	THQ	80,12	1	3881-34-1.1-THQ-2/3
41 mm	THQ	81,17	1	3881-41-1.3-THQ-1.4/2
41 mm	THQ	86,09	1	3881-41-1.3-THQ-2/3
54 mm	THQ	107,24	1	3881-54-1.6-THQ-1.4/2
54 mm	THQ	107,37	1	3881-54-1.6-THQ-1/1.25
54 mm	THQ	107,26	1	3881-54-1.6-THQ-2/3
67 mm	THQ	133,53	1	3881-67-1.6-THQ-1/1.25
67 mm	THQ	133,53	1	3881-67-1.6-THQ-1.4/2
67 mm	THQ	83,20	1	3881-67-1.6-THQ-2/3
80 mm	THQ	139,15	1	3881-80-1.6-THQ-7/1
80 mm	THQ	145,67	1	3881-80-1.6-THQ-1/1.25
80 mm	THQ	139,15	1	3881-80-1.6-THQ-1.4/2
80 mm	THQ	192,85	1	3881-80-1.6-THQ-2/3

Lâmina de fita de serra de carboneto com aprovação avançada



3881 Carbide Multi Set THS

		€		
41 mm	THS	89,27	1	3881-41-1.3-THS-1.4/2
54 mm	THS	117,95	1	3881-54-1.6-THS-1/1.25
54 mm	THS	117,95	1	3881-54-1.6-THS-1.4/2
67 mm	THS	145,67	1	3881-67-1.6-THS-1/1.25
67 mm	THS	145,67	1	3881-67-1.6-THS-1.4/2
67 mm	THS	146,23	1	3881-67-1.6-THS-2/3
80 mm	THS	151,36	1	3881-80-1.6-THS-7/1
80 mm	THS	151,36	1	3881-80-1.6-THS-1.4/2
80 mm	THS	192,85	1	3881-80-1.6-THS-2/3
100 mm	THS	75,80	1	3881-100-1.6-THS-7/1

Lâmina de fita de serra de carboneto mais avançada



3860 Unset Carbide TMC

		€		
41 mm	TMC	97,11	1	3860-41-1.3-TMC-1.4/2
41 mm	TMC	113,62	1	3860-41-1.3-TMC-2/3
54 mm	TMC	114,97	1	3860-54-1.3-TMC-1.4/2

		€		
54 mm	TMC	133,05	1	3860-54-1.3-TMC-2/3
54 mm	TMC	90,00	1	3860-54-1.6-TMC-7/1
54 mm	TMC	114,11	1	3860-54-1.6-TMC-1/1.25
54 mm	TMC	106,82	1	3860-54-1.6-TMC-1.4/2
54 mm	TMC	146,66	1	3860-54-1.6-TMC-2/3
67 mm	TMC	126,24	1	3860-67-1.6-TMC-1/1.25
67 mm	TMC	121,39	1	3860-67-1.6-TMC-1.4/2
67 mm	TMC	149,72	1	3860-67-1.6-TMC-2/3
80 mm	TMC	113,27	1	3860-80-1.1-TMC-1.4/2
80 mm	TMC	135,96	1	3860-80-1.6-TMC-7/1
80 mm	TMC	142,62	1	3860-80-1.6-TMC-1/1.25
80 mm	TMC	149,31	1	3860-80-1.6-TMC-1.4/2
80 mm	TMC	151,11	1	3860-80-1.6-TMC-2/3
100 mm	TMC	116,93	1	3860-100-1.1-TMC-1.4/2

Lâmina de fita de serra de carboneto versátil



3860 Unset Carbide TCD

		€		
27 mm	TCD	96,46	1	3860-27-0.9-TCD-3
27 mm	TCD	91,44	1	3860-27-0.9-TCD-3/4
34 mm	TCD	70,73	1	3860-34-1.1-TCD-2/3
34 mm	TCD	100,96	1	3860-34-1.1-TCD-3/4
34 mm	TCD	100,96	1	3860-34-1.1-TCD-3/4-W
41 mm	TCD	63,92	1	3860-41-1.3-TCD-1.4/2
41 mm	TCD	68,50	1	3860-41-1.3-TCD-1.9/2.1
41 mm	TCD	71,35	1	3860-41-1.3-TCD-2/3
41 mm	TCD	106,61	1	3860-41-1.3-TCD-3/4
54 mm	TCD	81,39	1	3860-54-1.6-TCD-1.4/2
54 mm	TCD	66,41	1	3860-54-1.6-TCD-1.9/2.1
54 mm	TCD	97,71	1	3860-54-1.6-TCD-2/3
54 mm	TCD	135,68	1	3860-54-1.6-TCD-3/4
67 mm	TCD	87,03	1	3860-67-1.6-TCD-1.4/2
67 mm	TCD	61,43	1	3860-67-1.6-TCD-1/1.25
80 mm	TCD	93,86	1	3860-80-1.6-TCD-5/0.8

Lâmina de serra de fita para barras endurecidas por indução



3860 Unset Carbide TCZ

		€		
27 mm	TCZ	89,46	1	3860-27-0.9-TCZ-3/4
34 mm	TCZ	70,76	1	3860-34-1.1-TCZ-2/3
34 mm	TCZ	100,95	1	3860-34-1.1-TCZ-3/4
41 mm	TCZ	69,66	1	3860-41-1.3-TCZ-2/3
41 mm	TCZ	106,61	1	3860-41-1.3-TCZ-3/4

Lâminas de serras de fita de carboneto não configuradas com chips TMC revestidas



3860 Unset Carbide TMC Coated

Image	Profile	€	Icons	Code
54 mm	TMC	115,28	1	3860-54-1.6-TMC-1/1.25S
54 mm	TMC	118,67	1	3860-54-1.6-TMC-1.4/2S
54 mm	TMC	129,97	1	3860-54-1.6-TMC-2/3S
67 mm	TMC	124,32	1	3860-67-1.6-TMC-1/1.25S
67 mm	TMC	129,97	1	3860-67-1.6-TMC-1.4/2S

CORTE DE MADEIRA

Sanduct® bimetálico



3861 Sandcut Bi-metal

Image	Profile	€	Icons	Code
4	Hook	2,88	1	3861-20-0.6-H-4
1.33	Hook	3,83	1	3861-27-0.9-H-1.33
1.15	Hook	8,72	1	3861-34-0.9-H-1.15
1.15	Hook	8,72	1	3861-34-1.1-H-1.15
1.15	Hook	11,57	1	3861-41-1.1-H-1.15
1.15	Hook	13,08	1	3861-54-1.1-H-1.15

Sanduct® sólido



3862 Sandcut Solid

Image	Profile	€	Icons	Code
1.15	Hook	14,12	1	3862-33-0.9-H-1.15
1.15	Hook	14,12	1	3862-33-1.1-H-1.15
1.15	Hook	15,09	1	3862-40-1.1-H-1.15

LÂMINAS ESPECIAIS PARA SERRAS DE FITA

Lâminas de fita de serra para isolamento Sandflex® de ponta dupla



3852 Sandflex® Twin Tip Insulation

Image	Profile	€	Icons	Code
27 mm	INS	13,39	1	3852-27-0.9-INS-3
34 mm	INS	14,42	1	3852-34-1.1-INS-3

LÂMINAS DE SERRA CIRCULAR HSS

Serra circular HSS



3815-32-1

Image	Profile	€	Icons	Code
200 mm	BW3	82,95	1	3815-200-2,0-32-1-03BW
200 mm	BW4	103,69	1	3815-200-2,0-32-1-04BW
225 mm	BW3	125,59	1	3815-225-2,0-32-1-03BW
225 mm	BW4	125,59	1	3815-225-2,0-32-1-04BW
225 mm	BW5	125,59	1	3815-225-2,0-32-1-05BW
225 mm	C6	125,59	1	3815-225-2,0-32-1-06C
250 mm	BW3	137,78	1	3815-250-2,0-32-1-03BW
250 mm	BW4	137,78	1	3815-250-2,0-32-1-04BW
250 mm	BW5	137,78	1	3815-250-2,0-32-1-05BW
250 mm	C6	137,78	1	3815-250-2,0-32-1-06C
275 mm	BW4	190,83	1	3815-275-2,5-32-1-04BW
275 mm	BW5	190,83	1	3815-275-2,5-32-1-05BW
275 mm	C6	190,83	1	3815-275-2,5-32-1-06C
275 mm	C8	190,83	1	3815-275-2,5-32-1-08C
300 mm	BW4	235,28	1	3815-300-2,5-32-1-04BW
300 mm	BW5	235,28	1	3815-300-2,5-32-1-05BW
300 mm	C5	235,28	1	3815-300-2,5-32-1-05C
300 mm	C6	235,28	1	3815-300-2,5-32-1-06C
300 mm	C8	235,28	1	3815-300-2,5-32-1-08C
315 mm	BW4	283,90	1	3815-315-2,5-32-1-04BW
315 mm	BW5	283,90	1	3815-315-2,5-32-1-05BW
315 mm	C6	283,90	1	3815-315-2,5-32-1-06C
315 mm	C8	283,90	1	3815-315-2,5-32-1-08C
350 mm	BW4	397,76	1	3815-350-2,5-32-1-04BW
350 mm	C6	397,76	1	3815-350-2,5-32-1-06C



Serra circular HSS



3815-40-2

Ø	V	€		
250 mm	BW3	137,78	1	3815-250-2.0-40-2-03BW
250 mm	BW4	137,78	1	3815-250-2.0-40-2-04BW
250 mm	BW5	137,78	1	3815-250-2.0-40-2-05BW
275 mm	BW3	190,83	1	3815-275-2.5-40-2-03BW
275 mm	BW4	190,83	1	3815-275-2.5-40-2-04BW
275 mm	BW5	190,83	1	3815-275-2.5-40-2-05BW
275 mm	C6	190,83	1	3815-275-2.5-40-2-06C
275 mm	C8	190,83	1	3815-275-2.5-40-2-08C
315 mm	BW4	283,90	1	3815-315-2.5-40-2-04BW
315 mm	BW5	283,90	1	3815-315-2.5-40-2-05BW
315 mm	C6	302,96	1	3815-315-3.0-40-2-06C

Serra circular HSS



3815-50-4

Ø	V	€		
370 mm	C8	397,76	1	3815-370-3.0-50-4-08C
370 mm	C10	397,76	1	3815-370-3.0-50-4-10C
400 mm	C10	522,87	1	3815-400-3.5-50-4-10C

LÂMINAS PARA SERROTES MECÂNICOS

Folhas de serrote mecânico para máquinas KASTO. SANDFLEX Bi-metal



3809

Ø	L	€		
10	300 mm	10,71	10	3809-300-25-1.25-10
14	300 mm	10,77	10	3809-300-25-1.25-14
6	300 mm	15,32	10	3809-300-32-1.60-6

Ø	L	€		
10	300 mm	15,44	10	3809-300-32-1.60-10
6	350 mm	12,50	10	3809-350-25-1.25-6
10	350 mm	12,50	10	3809-350-25-1.25-10
14	350 mm	12,50	10	3809-350-25-1.25-14
4	350 mm	16,48	10	3809-350-32-1.60-4
6	350 mm	16,48	10	3809-350-32-1.60-6
8	350 mm	16,48	10	3809-350-32-1.60-8
10	350 mm	16,48	10	3809-350-32-1.60-10
14	350 mm	16,48	10	3809-350-32-1.60-14
4	350 mm	22,08	10	3809-350-32-2.00-4
6	350 mm	22,08	10	3809-350-32-2.00-6
10	350 mm	22,08	10	3809-350-32-2.00-10
6	350 mm	27,66	10	3809-350-38-2.00-6
10	350 mm	27,66	10	3809-350-38-2.00-10
10	400 mm	15,91	10	3809-400-25-1.25-10
4	400 mm	20,94	10	3809-400-32-1.60-4
6	400 mm	20,94	10	3809-400-32-1.60-6
8	400 mm	20,94	10	3809-400-32-1.60-8
10	400 mm	20,94	10	3809-400-32-1.60-10
14	400 mm	20,94	10	3809-400-32-1.60-14
4	400 mm	24,56	10	3809-400-32-2.00-4
6	400 mm	24,56	10	3809-400-32-2.00-6
8	400 mm	25,05	10	3809-400-32-2.00-8
10	400 mm	24,56	10	3809-400-32-2.00-10
4	400 mm	28,00	10	3809-400-38-2.00-4
6	400 mm	28,00	10	3809-400-38-2.00-6
10	400 mm	28,00	10	3809-400-38-2.00-10
6	425 mm	24,73	10	3809-425-32-1.60-6
10	425 mm	28,00	10	3809-425-32-1.60-10
4	450 mm	26,16	10	3809-450-32-1.60-4
6	450 mm	26,16	10	3809-450-32-1.60-6
10	450 mm	26,16	10	3809-450-32-1.60-10
14	450 mm	26,16	10	3809-450-32-1.60-14
4	450 mm	30,83	10	3809-450-32-2.00-4
6	450 mm	30,83	10	3809-450-32-2.00-6
10	450 mm	30,83	10	3809-450-32-2.00-10
4	450 mm	35,06	10	3809-450-38-2.00-4
6	450 mm	35,06	10	3809-450-38-2.00-6
8	450 mm	35,06	10	3809-450-38-2.00-8
10	450 mm	35,06	10	3809-450-38-2.00-10
4	450 mm	43,92	10	3809-450-45-2.25-4
6	450 mm	43,92	10	3809-450-45-2.25-6
6	475 mm	50,75	10	3809-475-45-2.25-6
4	500 mm	40,96	10	3809-500-38-2.00-4
6	500 mm	40,96	10	3809-500-38-2.00-6
10	500 mm	40,96	10	3809-500-38-2.00-10
4	500 mm	52,47	10	3809-500-45-2.25-4
6	500 mm	52,47	10	3809-500-45-2.25-6
4	500 mm	62,01	10	3809-500-50-2.50-4
6	500 mm	62,01	10	3809-500-50-2.50-6
8	500 mm	62,93	10	3809-500-50-2.50-8
6	525 mm	42,81	10	3809-525-38-2.00-6
10	525 mm	42,81	10	3809-525-38-2.00-10
4	525 mm	54,85	10	3809-525-45-2.25-4
6	525 mm	54,85	10	3809-525-45-2.25-6
4	550 mm	57,69	10	3809-550-45-2.25-4
6	550 mm	57,69	10	3809-550-45-2.25-6
4	550 mm	68,75	10	3809-550-50-2.50-4
6	550 mm	68,75	10	3809-550-50-2.50-6
4	575 mm	62,84	10	3809-575-45-2.25-4
3	575 mm	71,69	10	3809-575-50-2.50-3
4	575 mm	71,69	10	3809-575-50-2.50-4
6	575 mm	71,69	10	3809-575-50-2.50-6
6	600 mm	50,96	10	3809-600-38-2.00-6
4	600 mm	63,05	10	3809-600-45-2.25-4
6	600 mm	63,05	10	3809-600-45-2.25-6
3	600 mm	76,25	10	3809-600-50-2.50-3
4	600 mm	76,25	10	3809-600-50-2.50-4
6	600 mm	76,25	10	3809-600-50-2.50-6
4	650 mm	84,90	5	3809-650-50-2.50-4
6	650 mm	84,90	5	3809-650-50-2.50-6
4	700 mm	92,76	5	3809-700-50-2.50-4
6	700 mm	92,76	5	3809-700-50-2.50-6
4	750 mm	108,25	5	3809-750-50-2.50-4
6	750 mm	108,25	5	3809-750-50-2.50-6

SANDFLEX Bi-metal

Sandflex® Bi-metal para p/serrote KASTO



3809 KA

		€		
6	400 mm	24,59	10	3809-400-32-2.00-6-KA
4	450 mm	35,06	10	3809-450-38-2.00-4-KA
6	450 mm	35,06	10	3809-450-38-2.00-6-KA
10	450 mm	35,06	10	3809-450-38-2.00-10-KA
6	500 mm	52,47	10	3809-500-45-2.25-6-KA
4	500 mm	62,01	10	3809-500-50-2.50-4-KA
6	500 mm	62,01	10	3809-500-50-2.50-6-KA
4	550 mm	68,75	10	3809-550-50-2.50-4-KA
6	550 mm	68,75	10	3809-550-50-2.50-6-KA
3	575 mm	71,69	10	3809-575-50-2.50-3-KA
4	575 mm	71,69	10	3809-575-50-2.50-4-KA
6	575 mm	71,69	10	3809-575-50-2.50-6-KA
10	575 mm	71,69	10	3809-575-50-2.50-10-KA
4	600 mm	76,25	10	3809-600-50-2.50-4-KA
6	600 mm	76,25	10	3809-600-50-2.50-6-KA
3	650 mm	84,90	5	3809-650-50-2.50-3-KA
4	650 mm	84,90	5	3809-650-50-2.50-4-KA
6	650 mm	84,90	5	3809-650-50-2.50-6-KA
3	700 mm	92,76	5	3809-700-50-2.50-3-KA
4	700 mm	92,76	5	3809-700-50-2.50-4-KA
6	700 mm	92,76	5	3809-700-50-2.50-6-KA

Folhas de serrote mecânico para máquinas KASTO. HSS

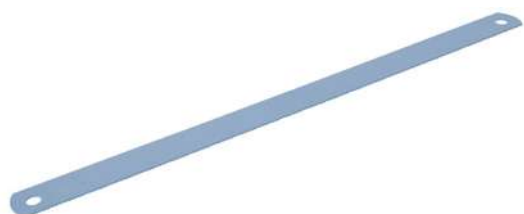

3802

		€		
6	300 mm	11,89	10	3802-300-25-1.25-6
10	300 mm	11,89	10	3802-300-25-1.25-10
14	300 mm	11,94	10	3802-300-25-1.25-14
6	300 mm	17,15	10	3802-300-32-1.60-6
10	300 mm	17,40	10	3802-300-32-1.60-10
6	350 mm	13,97	10	3802-350-25-1.25-6
10	350 mm	13,97	10	3802-350-25-1.25-10
14	350 mm	13,97	10	3802-350-25-1.25-14
4	350 mm	18,42	10	3802-350-32-1.60-4
6	350 mm	18,42	10	3802-350-32-1.60-6
8	350 mm	18,42	10	3802-350-32-1.60-8
10	350 mm	18,42	10	3802-350-32-1.60-10
14	350 mm	18,42	10	3802-350-32-1.60-14
6	400 mm	17,81	10	3802-400-25-1.25-6
10	400 mm	17,81	10	3802-400-25-1.25-10
14	400 mm	17,81	10	3802-400-25-1.25-14
4	400 mm	23,25	10	3802-400-32-1.60-4
6	400 mm	23,25	10	3802-400-32-1.60-6
8	400 mm	23,25	10	3802-400-32-1.60-8
10	400 mm	23,25	10	3802-400-32-1.60-10
14	400 mm	23,25	10	3802-400-32-1.60-14
4	400 mm	31,05	10	3802-400-38-2.00-4

		€		
6	400 mm	31,05	10	3802-400-38-2.00-6
10	400 mm	31,05	10	3802-400-38-2.00-10
6	425 mm	27,59	10	3802-425-32-1.60-6
10	425 mm	28,08	10	3802-425-32-1.60-10
4	450 mm	29,06	10	3802-450-32-1.60-4
6	450 mm	29,06	10	3802-450-32-1.60-6
10	450 mm	29,06	10	3802-450-32-1.60-10
14	450 mm	29,06	10	3802-450-32-1.60-14
4	450 mm	38,98	10	3802-450-38-2.00-4
6	450 mm	38,98	10	3802-450-38-2.00-6
8	450 mm	38,98	10	3802-450-38-2.00-8
10	450 mm	38,98	10	3802-450-38-2.00-10
8	475 mm	41,71	10	3802-475-38-2.00-8
4	500 mm	45,78	10	3802-500-38-2.00-4
6	500 mm	45,78	10	3802-500-38-2.00-6
8	500 mm	45,78	10	3802-500-38-2.00-8
10	500 mm	45,78	10	3802-500-38-2.00-10
10	500 mm	64,49	10	3802-500-45-2.25-10
4	500 mm	69,05	10	3802-500-50-2.50-4
6	500 mm	69,05	10	3802-500-50-2.50-6
6	525 mm	47,63	10	3802-525-38-2.00-6
8	525 mm	42,64	10	3802-525-38-2.00-8
10	525 mm	48,09	10	3802-525-38-2.00-10
6	550 mm	44,81	10	3802-550-38-2.00-6
4	550 mm	75,93	10	3802-550-50-2.50-4
6	550 mm	76,31	10	3802-550-50-2.50-6
8	550 mm	77,84	5	3802-550-50-2.50-8
10	550 mm	77,84	10	3802-550-50-2.50-10
4	575 mm	79,78	10	3802-575-50-2.50-4
6	575 mm	79,78	10	3802-575-50-2.50-6
4	600 mm	84,98	10	3802-600-50-2.50-4
6	600 mm	84,98	10	3802-600-50-2.50-6
8	600 mm	84,98	10	3802-600-50-2.50-8
4	650 mm	94,50	5	3802-650-50-2.50-4
6	650 mm	94,50	5	3802-650-50-2.50-6
3	700 mm	90,79	5	3802-700-50-2.50-3
4	700 mm	103,30	5	3802-700-50-2.50-4
6	700 mm	103,30	5	3802-700-50-2.50-6
4	750 mm	120,49	5	3802-750-50-2.50-4
6	750 mm	110,04	5	3802-750-50-2.50-6

HSS

Aço rápido p/serrote Kasto. HSS

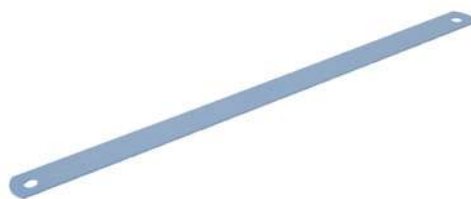

3802 KA

		€		
4	450 mm	38,98	10	3802-450-38-2.00-4-KA
6	450 mm	38,98	10	3802-450-38-2.00-6-KA
8	450 mm	38,98	10	3802-450-38-2.00-8-KA
10	450 mm	38,98	10	3802-450-38-2.00-10-KA
4	500 mm	69,05	10	3802-500-50-2.50-4-KA
6	500 mm	69,05	10	3802-500-50-2.50-6-KA
4	550 mm	76,31	10	3802-550-50-2.50-4-KA
8	550 mm	76,31	10	3802-550-50-2.50-8-KA
3	575 mm	79,78	10	3802-575-50-2.50-3-KA
4	575 mm	79,78	10	3802-575-50-2.50-4-KA
6	575 mm	79,78	10	3802-575-50-2.50-6-KA
4	650 mm	94,50	5	3802-650-50-2.50-4-KA
6	650 mm	86,26	5	3802-650-50-2.50-6-KA
2	700 mm	102,87	5	3802-700-50-2.50-2-KA
4	700 mm	103,30	5	3802-700-50-2.50-4-KA
6	700 mm	103,30	5	3802-700-50-2.50-6-KA

HSS



ACESSÓRIOS PARA SERRAS DE FITA

Escova de limpeza de serras



3870-BRUSH

	€		
60 mm	22,42	4	3870-BRUSH-60-6
80 mm	26,00	4	3870-BRUSH-80-6
80 mm	26,00	4	3870-BRUSH-80-8
80 mm	26,00	4	3870-BRUSH-80-10
100 mm	33,28	4	3870-BRUSH-100-10
100 mm	24,62	4	3870-BRUSH-100-12
100 mm	33,28	4	3870-BRUSH-100-10-HEX
100 mm	33,28	1	3870-BRUSH-100-13

Tacómetro



3870-TACHO

	€		
400 g	430,62	1	3870-TACHO METER

medidor de tensão



3870-TENSION

	€		
680 g	288,66	1	3870-TENSION METER

Refractómetro



3870-REFR

	€		
260 g	71,53	1	3870-REFRACTOMETER

Cunha em aço, 75mm de comprimento



3870-WEDGE

	€		
60 g	4,52	1	3870-WEDGE-3

Roda de ajuste de tensão para serras de fita



3870-Wheel

	€		
0.7790 kg	61,03	1	3870-WHEEL



Limas



LIMAS DE ENGENHARIA

Lima paralela. Embalagem industrial sem cabo



1-100...-0

		€		
100 mm	1	5,50	10	1-100-04-1-0
100 mm	2	4,93	10	1-100-04-2-0
100 mm	3	5,13	10	1-100-04-3-0
150 mm	1	5,13	10	1-100-06-1-0
150 mm	2	5,48	10	1-100-06-2-0
150 mm	3	5,68	10	1-100-06-3-0
200 mm	1	6,64	10	1-100-08-1-0
200 mm	2	7,05	10	1-100-08-2-0
200 mm	3	7,16	10	1-100-08-3-0
250 mm	1	8,67	10	1-100-10-1-0
250 mm	2	9,07	10	1-100-10-2-0
250 mm	3	9,21	10	1-100-10-3-0
300 mm	1	11,84	5	1-100-12-1-0
300 mm	2	12,11	5	1-100-12-2-0
300 mm	3	12,25	5	1-100-12-3-0
350 mm	1	16,93	5	1-100-14-1-0
350 mm	2	17,73	5	1-100-14-2-0

Embalagem industrial sem cabo

Lima Paralela Blister



ergo



1-100...-2

		€		
100 mm	1	6,91	5	1-100-04-1-2
100 mm	2	7,05	5	1-100-04-2-2
150 mm	1	8,73	5	1-100-06-1-2
150 mm	2	8,81	5	1-100-06-2-2
150 mm	3	8,80	5	1-100-06-3-2
200 mm	1	9,55	5	1-100-08-1-2
200 mm	2	10,01	5	1-100-08-2-2
200 mm	3	11,13	5	1-100-08-3-2
250 mm	1	12,33	5	1-100-10-1-2
250 mm	2	12,72	5	1-100-10-2-2
250 mm	3	12,07	5	1-100-10-3-2
300 mm	1	15,21	5	1-100-12-1-2
300 mm	2	15,48	5	1-100-12-2-2
300 mm	3	14,23	5	1-100-12-3-2

Single packed card

Lima paralela estreita. Embalagem industrial sem cabo



1-102

		€		
150 mm	2	7,72	10	1-102-06-2-0
150 mm	3	8,13	10	1-102-06-3-0
200 mm	1	9,21	10	1-102-08-1-0
200 mm	2	9,55	10	1-102-08-2-0
200 mm	3	9,67	10	1-102-08-3-0

Embalagem industrial sem cabo

Lima paralela para torno. Embalagem industrial sem cabo



1-104

		€		
250 mm	2	14,89	10	1-104-10-2-0
250 mm	3	15,42	10	1-104-10-3-0
300 mm	2	19,91	5	1-104-12-2-0
300 mm	3	21,39	5	1-104-12-3-0
350 mm	3	28,96	5	1-104-14-3-0

Embalagem industrial sem cabo

Lima paralela "Corte Öberg". Embalagem industrial sem cabo



1-106...-0

		€		
200 mm	1	10,90	10	1-106-08-1-0
250 mm	1	15,17	10	1-106-10-1-0
300 mm	1	19,37	5	1-106-12-1-0

Embalagem industrial sem cabo

Lima Oberg c/cabo



ergo



1-106...-2

		€		
200 mm	1	14,31	5	1-106-08-1-2
250 mm	1	18,32	5	1-106-10-1-2
300 mm	1	22,11	5	1-106-12-1-2

Single packed carded

Lima chata. Embalagem industrial sem cabo



1-110...-0

		€		
100 mm	1	4,69	10	1-110-04-1-0
100 mm	2	4,93	10	1-110-04-2-0
100 mm	2	5,13	10	1-110-04-3-0
150 mm	1	5,13	10	1-110-06-1-0
150 mm	2	5,48	10	1-110-06-2-0
150 mm	3	5,68	10	1-110-06-3-0
200 mm	1	6,64	10	1-110-08-1-0
200 mm	2	7,05	10	1-110-08-2-0
200 mm	2	7,16	10	1-110-08-3-0
250 mm	1	8,67	10	1-110-10-1-0
250 mm	2	9,07	10	1-110-10-2-0
250 mm	3	9,21	10	1-110-10-3-0
300 mm	1	11,84	5	1-110-12-1-0
300 mm	2	12,11	5	1-110-12-2-0
300 mm	3	12,25	5	1-110-12-3-0
350 mm	1	16,93	5	1-110-14-1-0

Embalagem industrial sem cabo

Lima chata, Blister c/cabo



ergo



1-110...-2

			€		
150 mm	1	8,73	5	1-110-06-1-2	
150 mm	2	8,81	5	1-110-06-2-2	
150 mm	3	8,71	5	1-110-06-3-2	
200 mm	1	9,55	5	1-110-08-1-2	
200 mm	2	10,01	5	1-110-08-2-2	
200 mm	3	10,09	5	1-110-08-3-2	
250 mm	1	12,33	5	1-110-10-1-2	
250 mm	2	12,72	5	1-110-10-2-2	
250 mm	3	11,57	5	1-110-10-3-2	
300 mm	1	14,05	5	1-110-12-1-2	
300 mm	2	16,38	5	1-110-12-2-2	
300 mm	3	14,42	5	1-110-12-3-2	

Single packed carded

Lima folha de oliveira. Embalagem industrial sem cabo



1-111...-0

			€		
100 mm	1	5,13	10	1-111-04-1-0	
100 mm	2	5,41	10	1-111-04-2-0	
100 mm	3	5,60	10	1-111-04-3-0	
150 mm	1	5,60	10	1-111-06-1-0	
150 mm	2	6,42	10	1-111-06-2-0	
150 mm	3	6,64	10	1-111-06-3-0	
200 mm	1	7,84	10	1-111-08-1-0	
200 mm	2	8,88	10	1-111-08-2-0	

Embalagem industrial sem cabo

Lima folha de oliveira. Embalagem individual em blister



ergo



1-111...-2

			€		
150 mm	2	9,90	5	1-111-06-2-2	

Embalagem individual em blister

Lima para platinados



1-115

			€		
110 mm	3	10,45	10	1-115-11-3-1	

Lima para oficina, com dois cantos (tipo USA). Embalagem industrial sem cabo



1-143...-0

			€		
100 mm	1	4,25	10	1-143-04-1-0	
150 mm	1	4,62	10	1-143-06-1-0	
200 mm	1	5,96	10	1-143-08-1-0	
250 mm	1	7,84	10	1-143-10-1-0	
300 mm	1	10,70	5	1-143-12-1-0	

Embalagem industrial sem cabo

Lima para oficina, 2 cantos, c/cabo



ergo



1-143...-2

			€		
150 mm	1	8,53	5	1-143-06-1-2	
200 mm	1	9,82	5	1-143-08-1-2	
250 mm	1	11,71	5	1-143-10-1-2	
300 mm	1	14,75	5	1-143-12-1-2	

Single packed carded

Lima diagonal embalagem individual



ergo



1-320 ...-2

			€		
200 mm	2	21,45	5	1-320-08-2-2	
250 mm	2	23,41	5	1-320-10-2-2	

Single packed carded

Lima paralela corte diagonal. Embalagem industrial sem cabo



1-320...-0

			€		
200 mm	2	17,73	10	1-320-08-2-0	
250 mm	2	19,63	10	1-320-10-2-0	
300 mm	2	21,64	5	1-320-12-2-0	

Embalagem industrial sem cabo



Lima meia-cana. Embalagem industrial sem cabo



1-210...-0

		€		
100 mm	1	8,06	10	1-210-04-1-0
100 mm	2	8,13	10	1-210-04-2-0
100 mm	3	8,24	10	1-210-04-3-0
150 mm	1	8,24	10	1-210-06-1-0
150 mm	2	8,47	10	1-210-06-2-0
150 mm	3	8,60	10	1-210-06-3-0
200 mm	1	10,17	10	1-210-08-1-0
200 mm	2	10,36	10	1-210-08-2-0
200 mm	3	10,56	10	1-210-08-3-0
250 mm	1	12,38	10	1-210-10-1-0
250 mm	2	12,78	10	1-210-10-2-0
250 mm	3	13,06	10	1-210-10-3-0
300 mm	1	18,42	5	1-210-12-1-0
300 mm	2	18,82	5	1-210-12-2-0
300 mm	3	19,08	5	1-210-12-3-0
350 mm	1	25,44	5	1-210-14-1-0

Embalagem industrial sem cabo

Lima redonda. Embalagem industrial sem cabo



1-230...-0

		€		
100 mm	1	4,82	10	1-230-04-1-0
100 mm	2	5,08	10	1-230-04-2-0
100 mm	3	5,21	10	1-230-04-3-0
150 mm	1	5,41	10	1-230-06-1-0
150 mm	2	5,68	10	1-230-06-2-0
150 mm	3	5,79	10	1-230-06-3-0
200 mm	1	6,42	10	1-230-08-1-0
200 mm	2	6,82	10	1-230-08-2-0
200 mm	3	7,12	10	1-230-08-3-0
250 mm	1	7,84	10	1-230-10-1-0
250 mm	2	8,73	10	1-230-10-2-0
250 mm	3	9,35	10	1-230-10-3-0
300 mm	1	10,90	5	1-230-12-1-0
300 mm	2	11,52	5	1-230-12-2-0
300 mm	3	11,71	5	1-230-12-3-0

Embalagem industrial sem cabo

Lima triangular. Embalagem industrial sem cabo



1-170...-0

		€		
100 mm	1	5,40	10	1-170-04-1-0
100 mm	2	5,43	10	1-170-04-2-0
100 mm	3	5,79	10	1-170-04-3-0
150 mm	1	6,07	10	1-170-06-1-0
150 mm	2	6,46	10	1-170-06-2-0
150 mm	3	6,64	10	1-170-06-3-0
200 mm	1	8,00	10	1-170-08-1-0
200 mm	2	8,47	10	1-170-08-2-0
200 mm	3	8,67	10	1-170-08-3-0
250 mm	1	11,30	10	1-170-10-1-0
250 mm	2	11,78	10	1-170-10-2-0
250 mm	3	12,06	10	1-170-10-3-0
300 mm	1	14,60	5	1-170-12-1-0
300 mm	2	15,83	5	1-170-12-2-0

Embalagem industrial sem cabo

Lima meia cana, c/cabo



ergo



1-210...-2

		€		
100 mm	1	10,01	5	1-210-04-1-2
100 mm	2	10,01	5	1-210-04-2-2
150 mm	1	10,44	5	1-210-06-1-2
150 mm	2	10,63	5	1-210-06-2-2
150 mm	3	11,30	5	1-210-06-3-2
200 mm	1	11,98	5	1-210-08-1-2
200 mm	2	12,87	5	1-210-08-2-2
200 mm	3	11,67	5	1-210-08-3-2
250 mm	1	16,13	5	1-210-10-1-2
250 mm	2	16,93	5	1-210-10-2-2
250 mm	3	14,21	5	1-210-10-3-2
300 mm	1	21,71	5	1-210-12-1-2
300 mm	2	21,95	5	1-210-12-2-2
300 mm	3	23,50	5	1-210-12-3-2

Single packed carded

Lima redonda, c/cabo



ergo



1-230...-2

		€		
100 mm	1	6,65	5	1-230-04-1-2
100 mm	2	6,96	5	1-230-04-2-2
150 mm	1	7,88	5	1-230-06-1-2
150 mm	2	8,05	5	1-230-06-2-2
150 mm	3	7,73	5	1-230-06-3-2
200 mm	1	8,88	5	1-230-08-1-2
200 mm	2	9,21	5	1-230-08-2-2
200 mm	3	8,92	5	1-230-08-3-2
250 mm	1	11,25	5	1-230-10-1-2
250 mm	2	11,78	5	1-230-10-2-2
250 mm	3	11,52	5	1-230-10-3-2
300 mm	1	13,90	5	1-230-12-1-2
300 mm	2	13,90	5	1-230-12-2-2
300 mm	3	13,36	5	1-230-12-3-2

Single packed carded

Lima triangular, c/cabo



ergo



1-170...-2

		€		
100 mm	2	8,73	5	1-170-04-2-2
150 mm	1	8,97	5	1-170-06-1-2
150 mm	2	9,44	5	1-170-06-2-2
150 mm	3	10,72	5	1-170-06-3-2
200 mm	1	11,30	5	1-170-08-1-2
200 mm	2	11,71	5	1-170-08-2-2
200 mm	3	13,92	5	1-170-08-3-2
250 mm	1	14,57	5	1-170-10-1-2
250 mm	2	14,60	5	1-170-10-2-2
250 mm	3	17,76	5	1-170-10-3-2

Single packed carded

Lima quadrada. Embalagem industrial sem cabo



1-160...-0

Length	Quantity	Price (€)	Code
100 mm	1	5,58	10 1-160-04-1-0
100 mm	2	5,83	10 1-160-04-2-0
100 mm	3	5,96	10 1-160-04-3-0
150 mm	1	5,38	10 1-160-06-1-0
150 mm	2	5,79	10 1-160-06-2-0
150 mm	3	6,01	10 1-160-06-3-0
200 mm	1	6,45	10 1-160-08-1-0
200 mm	2	6,76	10 1-160-08-2-0
200 mm	3	6,91	10 1-160-08-3-0
250 mm	1	9,14	10 1-160-10-1-0
250 mm	2	9,60	10 1-160-10-2-0
250 mm	3	9,76	10 1-160-10-3-0
300 mm	1	13,13	5 1-160-12-1-0
300 mm	2	13,67	5 1-160-12-2-0
300 mm	3	16,10	5 1-160-12-3-0

Embalagem industrial sem cabo

Lima quadrada c/cabo



1-160...-2

Length	Quantity	Price (€)	Code
100 mm	1	7,88	5 1-160-04-1-2
100 mm	2	8,24	5 1-160-04-2-2
150 mm	1	8,67	5 1-160-06-1-2
150 mm	2	8,73	5 1-160-06-2-2
150 mm	3	9,13	5 1-160-06-3-2
200 mm	1	9,76	5 1-160-08-1-2
200 mm	2	10,17	5 1-160-08-2-2
200 mm	3	11,67	5 1-160-08-3-2
250 mm	1	12,06	5 1-160-10-1-2
250 mm	2	12,87	5 1-160-10-2-2
250 mm	3	14,21	5 1-160-10-3-2
300 mm	1	17,37	5 1-160-12-1-2
300 mm	2	17,02	5 1-160-12-2-2
300 mm	3	17,17	5 1-160-12-3-2

Conjunto de 6 limas para mecânica



1-476

Length	Quantity	Price (€)	Code
100 mm	3	49,10	1 1-476-04-3-2

ERGO™ handle 1-160-04-3-2, 1-111-04-3-2, 1-230-04-3-2, 1-170-04-3-2, 1-210-04-3-2, 1-100-04-3-2

Conjunto de 3 limas para mecânica



1-473

Length	Quantity	Price (€)	Code
150 mm	2	28,47	5 1-473-06-2-2

ERGO™ handle

1-230-06-2-2	
1-210-06-2-2	
1-100-06-2-2	

Conjunto de 3 limas. Cabo ERGO™



1-473-08-2-2

Length	Quantity	Price (€)	Code
200 mm	2	32,87	5 1-473-08-2-2

Cabo ERGO™

1-230-08-2-2	
1-210-08-2-2	
1-100-08-2-2	

Conjunto de 3 limas. Cabo ERGO™



1-473-10-2-2_1

Length	Quantity	Price (€)	Code
250 mm	2	38,72	5 1-473-10-2-2

Cabo ERGO™

1-230-10-2-2	
1-210-10-2-2	
1-100-10-2-2	

Conjunto de 5 limas para mecânica



1-477

Length	Quantity	Price (€)	Code
200 mm	2	58,08	5 1-477-08-2-2

ERGO™ handle

1-100-08-2-2	
1-210-08-2-2	
6-343-08-2-2	
1-230-08-2-2	
1-170-08-2-2	



Conjunto de 5 Limas. Cabo ERGO™



1-477-10-2-2

		€		
250 mm	2	69,77	5	1-477-10-2-2

Cabo ERGO™

1-100-10-2-2				
1-210-10-2-2				
6-343-10-2-2				
1-230-10-2-2				
1-170-10-2-2				

Conjunto de 5 limas para mecânica



1-478

		€		
200 mm	1&2	52,63	5	1-478-08-1-2

ERGO™ handle

1-210-08-1-2				
1-230-08-1-2				
1-100-08-1-2, 1-100-08-2-2				
1-160-08-1-2				

Conjunto de 5 limas. Cabo ERGO™



1-478-10-1-2_1

		€		
250 mm	1&2	62,64	5	1-478-10-1-2

Cabo ERGO™

1-210-10-1-2				
1-230-10-1-2				
1-100-10-1-2, 1-100-10-2-2				
1-160-10-1-2				

Conjunto de 5 limas para mecânica



1-479

		€		
200 mm	1	61,85	5	1-479-08-1-2

Cabo ERGO™

4-138-08-1-2				
1-210-08-1-2				
6-343-08-2-2				
1-230-08-1-2				
1-100-08-1-2				

Conjunto de 5 limas. Cabo ERGO™



1-479-08-2-2

		€		
200 mm	2	62,90	5	1-479-08-2-2

Cabo ERGO™

4-138-08-1-2				
1-210-08-2-2				
6-343-08-2-2				
1-230-08-2-2				
1-100-08-2-2				

LIMAS DE AFIAR

Limatões paralelos chatos/afiação de corrente. Para motosserra, embalagem individual em blister



166-2

		€		
150 mm	3	8,74	5	166-6-16-2.5-2

Para motosserra, embalagem individual em blister

Limatões paralelos chatos para afiação de corrente. Para motosserra, embalagem industrial sem cabo



166/167-12

		€		
150 mm	3	4,26	12	166-6-16-2.5-12
200 mm	1	7,43	12	167-8-21-3.2-12

Para motosserra, embalagem industrial sem cabo

Limatões redondos para afiação de corrente. Para motosserra, 1 lima por embalagem



168 - 1P

		€		
150 mm	3.2 mm	1,75	12	168-6-3.2-1P
150 mm	3.5 mm	1,75	12	168-6-3.5-1P
200 mm	4.0 mm	1,75	12	168-8-4.0-1P
200 mm	4.5 mm	1,75	12	168-8-4.5-1P
200 mm	4.8 mm	1,75	12	168-8-4.8-1P
200 mm	5.2 mm	1,75	12	168-8-5.2-1P
200 mm	5.5 mm	1,75	12	168-8-5.5-1P
200 mm	6.3 mm	2,01	12	168-8-6.3-1P

Para motosserra, 1 lima por embalagem

Limatões redondos para afiação de corrente. Para motosserra, 3 limas por embalagem



168 - 3P

Length	Width	Price (€)	Quantity	Code
150 mm	3.2 mm	5,04	12	168-6-3.2-3P
150 mm	3.5 mm	5,04	12	168-6-3.5-3P
200 mm	4.0 mm	5,04	12	168-8-4.0-3P
200 mm	4.5 mm	5,04	12	168-8-4.5-3P
200 mm	4.8 mm	5,04	12	168-8-4.8-3P
200 mm	5.2 mm	5,04	12	168-8-5.2-3P
200 mm	5.5 mm	5,04	12	168-8-5.5-3P
200 mm	6.3 mm	5,04	12	168-8-6.3-3P

Para motosserra, 3 limas por embalagem

Limatões redondos para afiação de corrente. Para motosserra, 6 limas por embalagem



168-8

Length	Width	Price (€)	Quantity	Code
200 mm	4.0 mm	1,71	6	168-8-4.0-6
200 mm	4.5 mm	1,71	6	168-8-4.5-6
200 mm	4.8 mm	1,71	6	168-8-4.8-6
200 mm	5.2 mm	1,72	6	168-8-5.2-6
200 mm	5.5 mm	1,71	6	168-8-5.5-6

Para motosserra, 6 limas por embalagem

Conjunto de limatões para motosserra



ergo®



168-C-G

Length	Width	Price (€)	Quantity	Code
200 mm	4.0 mm	29,11	10	168-COMBI-4.0-6922
200 mm	4.8 mm	29,90	10	168-COMBI-4.8-6920
200 mm	5.5 mm	29,90	10	168-COMBI-5.5-6924

Conjunto de limatões para motosserra



ergo®



168-C

Length	Width	Price (€)	Quantity	Code
200 mm	4.0 mm	15,02	10	168-COMBI-4.0
200 mm	4.5 mm	15,02	10	168-COMBI-4.5
200 mm	4.8 mm	15,02	10	168-COMBI-4.8
200 mm	5.5 mm	15,02	10	168-COMBI-5.5

Lima paralela para serra. Embalagem industrial sem cabo



4-138...-0

Length	Width	Price (€)	Quantity	Code
150 mm		7,60	10	4-138-06-1-0
200 mm		9,78	10	4-138-08-1-0
250 mm		12,04	10	4-138-10-1-0
300 mm		16,82	5	4-138-12-1-0

Embalagem industrial sem cabo

Lima paralela para serra, c/cabo



ergo®



4-138...-2

Length	Width	Price (€)	Quantity	Code
150 mm		10,79	5	4-138-06-1-2
200 mm		13,01	5	4-138-08-1-2
250 mm		15,09	5	4-138-10-1-2
300 mm		19,48	5	4-138-12-1-2

Single packed carded

Lima paralela para serra. Embalagem industrial sem cabo



4-140...-0

Length	Width	Price (€)	Quantity	Code
150 mm	1	7,95	10	4-140-06-1-0
200 mm	1	9,92	10	4-140-08-1-0
250 mm	1	12,18	10	4-140-10-1-0

Embalagem industrial sem cabo

Lima paralela para serra, c/cabo



ergo®



4-140...-2

Length	Width	Price (€)	Quantity	Code
200 mm	1	13,01	5	4-140-08-1-2
250 mm	1	15,34	5	4-140-10-1-2

Single packed carded

Lima paralela fina para serra. Embalagem industrial sem cabo



4-142

Length	Width	Price (€)	Quantity	Code
150 mm	1	7,33	10	4-142-06-1-0
200 mm	1	8,48	10	4-142-08-1-0
250 mm	1	11,09	10	4-142-10-1-0

Embalagem industrial sem cabo



Lima paralela fina para serra. Embalagem industrial sem cabo



4-144...-0

Comprimento	Quantidade	Preço	Embalagem	Artigo
200 mm	2	10,25	10	4-144-08-2-0

Embalagem industrial sem cabo

Lima paralela para serra, c/cabo



ergo



4-144...-2

Comprimento	Quantidade	Preço	Embalagem	Artigo
200 mm	2	13,39	5	4-144-08-2-2

Single packed carded

Lima paralela para madeira. Embalagem individual em blister



ergo



4-152

Comprimento	Quantidade	Preço	Embalagem	Artigo
200 mm	2 & 2	16,44	5	4-152-08-2-2

Embalagem individual em blister

Lima paralela para metais. Embalagem individual em bliste



ergo



4-153

Comprimento	Quantidade	Preço	Embalagem	Artigo
200 mm	1 & 1	16,44	5	4-153-08-1-2

Embalagem individual em bliste

Conjunto de 2 limas 4-152 + 4-153. Embalagem industrial com cabo



ergo



4-154

Comprimento	Quantidade	Preço	Embalagem	Artigo
200 mm	1 & 2	31,18	10	4-154-08-2-2

Embalagem industrial com cabo

Lima para fazendeiro dupla função. Embalagem industrial sem cabo



4-155

Comprimento	Quantidade	Preço	Embalagem	Artigo
200 mm	1	12,22	10	4-155-08-2-0
250 mm	1	16,18	5	4-155-10-2-0

Embalagem industrial sem cabo

Lima triangular para serra regular. <Embalagem industrial sem cabo



4-183...-0

Comprimento	Quantidade	Preço	Embalagem	Artigo
100 mm	2	4,40	10	4-183-04-2-0
125 mm	2	5,09	10	4-183-05-2-0
150 mm	2	6,06	10	4-183-06-2-0
175 mm	2	7,19	10	4-183-07-2-0
200 mm	2	9,58	10	4-183-08-2-0
250 mm	2	11,98	10	4-183-10-2-0

<Embalagem industrial sem cabo

Lima triangular para serra regular, c/cabo



ergo



4-183...-2

Comprimento	Quantidade	Preço	Embalagem	Artigo
100 mm	2	6,19	5	4-183-04-2-2
125 mm	2	7,59	5	4-183-05-2-2
150 mm	2	7,78	5	4-183-06-2-2
175 mm	2	9,21	5	4-183-07-2-2
200 mm	2	10,96	5	4-183-08-2-2

Single packed carded

Lima triangular fina para serras. Embalagem industrial sem cabo



4-186...-0

Comprimento	Quantidade	Preço	Embalagem	Artigo
100 mm	2	5,14	10	4-186-04-2-0
125 mm	2	5,14	10	4-186-05-2-0
150 mm	2	5,14	10	4-186-06-2-0
175 mm	2	7,27	10	4-186-07-2-0
200 mm	2	8,21	10	4-186-08-2-0

Embalagem industrial sem cabo

Lima triangular fina p/serras, c/cabo



ergo®



4-186...-2

			€		
100 mm	2		6,59	5	4-186-04-2-2
125 mm	2		7,32	5	4-186-05-2-2
150 mm	2		7,78	5	4-186-06-2-2

Single packed carded

Lima triangular para serra extra fina.
Embalagem industrial sem cabo



4-187...-0

			€		
100 mm	2		5,43	10	4-187-04-2-0
112 mm	2		5,86	10	4-187-45-2-0
125 mm	2		5,86	10	4-187-05-2-0
150 mm	2		6,20	10	4-187-06-2-0
175 mm	2		8,83	10	4-187-07-2-0

Embalagem industrial sem cabo

Lima triangular p/serra extra fina, c/cabo



ergo®



4-187...-2

			€		
125 mm	2		7,93	5	4-187-05-2-2
150 mm	2		9,47	5	4-187-06-2-2

Single packed carded

Lima triangular dupla para serras extra-fina. Embalagem industrial sem cabo



4-188...-0

			€		
125 mm	2		7,12	10	4-188-05-2-0
150 mm	2		7,95	10	4-188-06-2-0

Embalagem industrial sem cabo

Triangular p/serra extra fina, c/cabo



ergo®



4-188...-2

			€		
125 mm	2		9,10	5	4-188-05-2-2

Single packed carded

Lima triangular para serra com duas espigas. Embalagem industrial com cabo



4-190...-0

			€		
175 mm	2		7,19	10	4-190-07-2-0
200 mm	2		7,68	10	4-190-08-2-0

Embalagem industrial com cabo

Lima triangular dupla p/serra, c/cabo



ergo®



4-190...-2

			€		
150 mm	2		7,80	5	4-190-06-2-2
175 mm	2		9,38	5	4-190-07-2-2
200 mm	2		8,66	5	4-190-08-2-2

Single packed carded

Lima triangular para serra cantos redondos. Embalagem industrial sem cabo



4-192...-0

			€		
150 mm	2		8,41	10	4-192-06-2-0
175 mm	2		9,58	10	4-192-07-2-0
200 mm	2		10,25	10	4-192-08-2-0

Embalagem industrial sem cabo

Triangular p/serra cantos redondos



ergo®



4-192...-2

			€		
150 mm	2		11,64	5	4-192-06-2-2
200 mm	2		13,39	5	4-192-08-2-2

Single packed carded



Triangular para fitas de serra



4-202 - 4-204

Comprimento	Quantidade	Preço	Empacotamento	Modelo
216 mm	2	10,47	10	4-202-85-2-0
216 mm	2	13,35	10	4-204-85-2-0

Lima gume duplo Wasa®. Embalagem industrial sem cabo



4-272...-0

Comprimento	Quantidade	Preço	Empacotamento	Modelo
150 mm	3	8,48	10	4-272-06-3-0

Embalagem industrial sem cabo

Lima gume duplo Wasa®. Embalagem individual em blister



4-272...-2

Comprimento	Quantidade	Preço	Empacotamento	Modelo
125 mm	3	11,64	5	4-272-05-3-2
150 mm	3	11,64	5	4-272-06-3-2

Embalagem individual em blister

GROSAS

Paralela, Embalagem industrial, sem cabo



6-344...-0

Comprimento	Quantidade	Preço	Empacotamento	Modelo
200 mm	2	10,47	10	6-344-08-2-0
250 mm	2	11,86	10	6-344-10-2-0

Industry pack, unhandled

Grosa paralela. Embalagem individual em blister



6-344...-2

Comprimento	Quantidade	Preço	Empacotamento	Modelo
200 mm	2	14,48	5	6-344-08-2-2
250 mm	2	17,60	5	6-344-10-2-2

Embalagem individual em blister

Grosa meia-cana. Embalagem industrial sem cabo



6-342...-0

Comprimento	Quantidade	Preço	Empacotamento	Modelo
150 mm	2	8,67	10	6-342-06-2-0
200 mm	1	10,01	10	6-342-08-1-0
200 mm	2	11,64	10	6-342-08-2-0
250 mm	1	13,67	10	6-342-10-1-0
250 mm	2	14,75	10	6-342-10-2-0

Embalagem industrial sem cabo

Grosa meia-cana. Embalagem individual em blister



6-342...-2

Comprimento	Quantidade	Preço	Empacotamento	Modelo
150 mm	2	12,06	5	6-342-06-2-2
200 mm	1	13,53	5	6-342-08-1-2
200 mm	2	16,25	5	6-342-08-2-2
250 mm	1	16,80	5	6-342-10-1-2
250 mm	2	19,91	5	6-342-10-2-2

Embalagem individual em blister

Grosa meia-cana, tipo Cabinet. Embalagem industrial sem cabo



6-343...-0

Comprimento	Quantidade	Preço	Empacotamento	Modelo
200 mm	2	15,42	10	6-343-08-2-0
200 mm	3	17,60	10	6-343-08-3-0
250 mm	2	19,63	10	6-343-10-2-0
250 mm	3	22,48	10	6-343-10-3-0

Embalagem industrial sem cabo

Grosa meia-cana, tipo Cabinet. Embalagem individual em blister



6-343...-2

Comprimento	Quantidade	Preço	Empacotamento	Modelo
200 mm	2	17,95	5	6-343-08-2-2
250 mm	2	21,94	5	6-343-10-2-2

Embalagem individual em blister

Grosa redonda. Embalagem industrial sem cabo



6-345...-0

Comprimento	Quantidade	Preço	Empacotamento	Modelo
200 mm	2	9,59	10	6-345-08-2-0
250 mm	2	11,60	10	6-345-10-2-0

Embalagem industrial sem cabo

Grosa redonda. Embalagem individual em blister



6-345...-2

Comprimento	Quantidade	Preço	Empacotamento	Modelo
200 mm	1	10,91	5	6-345-08-1-2
200 mm	2	11,13	5	6-345-08-2-2
250 mm	1	13,81	5	6-345-10-1-2

Embalagem individual em blister

Conjunto de 3 grosas



6-470

Comprimento	Quantidade	Preço	Empacotamento	Modelo
200 mm	2	53,47	5	6-470-08-2-2

Cabo ERGO™

6-345-08-2-2

6-342-08-2-2

4-152-08-2-2

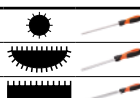

LIMAS DE DENTES FRESADOS

Lima chata Pansar®. Embalagem industrial sem cabo



3-330

Comprimento	Quantidade	Preço	Empacotamento	Modelo
300 mm	1	26,59	5	3-330-12-1-0
300 mm	2	28,39	5	3-330-12-2-0
350 mm	1	28,57	5	3-330-14-1-0
350 mm	2	32,80	5	3-330-14-2-0

Embalagem industrial sem cabo

Lima meia-cana Pansar®. Embalagem industrial sem cabo



3-331

Comprimento	Quantidade	Preço	Empacotamento	Modelo
350 mm	1	29,11	5	3-331-14-1-0

Embalagem industrial sem cabo

Lima manual. Embalagem industrial com cabo



FM10

Comprimento	Quantidade	Preço	Empacotamento	Modelo
300 mm	4 & 5	18,55	5	FM12
250 mm	4 & 5	18,55	5	FM10

Embalagem industrial com cabo

Lima manual, meia-cana. Embalagem industrial com cabo



HRFM10

Comprimento	Quantidade	Preço	Empacotamento	Modelo
250 mm	5	22,65	5	HRFM10

Embalagem industrial com cabo

LIMAS DE AGULHAS

Lima paralela. Embalagem industrial sem cabo



2-300

Comprimento	Quantidade	Preço	Empacotamento	Modelo
140 mm	0	7,73	10	2-300-14-0-0
140 mm	2	7,73	10	2-300-14-2-0
140 mm	4	8,15	10	2-300-14-4-0
160 mm	0	8,39	10	2-300-16-0-0
160 mm	1	8,39	10	2-300-16-1-0
160 mm	2	8,39	10	2-300-16-2-0
160 mm	4	8,90	10	2-300-16-4-0
180 mm	0	9,76	10	2-300-18-0-0
180 mm	2	9,76	10	2-300-18-2-0

Embalagem industrial sem cabo

Lima chata. Embalagem industrial sem cabo



2-301

Comprimento	Quantidade	Preço	Empacotamento	Modelo
140 mm	0	8,90	10	2-301-14-0-0
140 mm	2	8,90	10	2-301-14-2-0
160 mm	0	9,76	10	2-301-16-0-0
160 mm	1	9,76	10	2-301-16-1-0
160 mm	2	9,76	10	2-301-16-2-0

Embalagem industrial sem cabo



Lima meia-cana. Embalagem industrial sem cabo



2-304

			€		
140 mm	0	10,14	10	2-304-14-0-0	
140 mm	2	10,14	10	2-304-14-2-0	
140 mm	4	10,93	10	2-304-14-4-0	
160 mm	0	11,18	10	2-304-16-0-0	
160 mm	1	11,18	10	2-304-16-1-0	
160 mm	2	11,18	10	2-304-16-2-0	
160 mm	4	11,81	10	2-304-16-4-0	
180 mm	0	12,92	10	2-304-18-0-0	
180 mm	2	12,92	10	2-304-18-2-0	

Embalagem industrial sem cabo

Lima meia-cana. Embalagem industrial sem cabo



2-313

			€		
160 mm	0	11,18	10	2-313-16-0-0	

Embalagem industrial sem cabo

Lima redonda. Embalagem industrial sem cabo



2-307

			€		
140 mm	0	7,73	10	2-307-14-0-0	
140 mm	2	7,73	10	2-307-14-2-0	
140 mm	4	8,15	10	2-307-14-4-0	
160 mm	0	8,39	10	2-307-16-0-0	
160 mm	1	8,39	10	2-307-16-1-0	
160 mm	2	8,39	10	2-307-16-2-0	
160 mm	4	8,90	10	2-307-16-4-0	
180 mm	0	9,76	10	2-307-18-0-0	
180 mm	2	9,76	10	2-307-18-2-0	

Embalagem industrial sem cabo

Lima oval. Embalagem industrial sem cabo



2-305

			€		
160 mm	1	11,18	10	2-305-16-1-0	
160 mm	2	11,18	10	2-305-16-2-0	

Embalagem industrial sem cabo

Lima convexa. Embalagem industrial sem cabo



2-306

			€		
160 mm	1	11,18	10	2-306-16-1-0	
160 mm	2	11,18	10	2-306-16-2-0	

Embalagem industrial sem cabo

Lima triangular. Embalagem industrial sem cabo



2-302

			€		
140 mm	0	8,90	10	2-302-14-0-0	
140 mm	2	8,90	10	2-302-14-2-0	
140 mm	4	9,28	10	2-302-14-4-0	
160 mm	0	9,76	10	2-302-16-0-0	
160 mm	1	9,76	10	2-302-16-1-0	
160 mm	2	9,76	10	2-302-16-2-0	
160 mm	4	10,14	10	2-302-16-4-0	
180 mm	0	11,18	10	2-302-18-0-0	
180 mm	2	11,18	10	2-302-18-2-0	

Embalagem industrial sem cabo

Lima triangular extra-larga corte duplo. Embalagem industrial sem cabo



2-309

			€		
160 mm	2	9,76	10	2-309-16-2-0	
160 mm	4	10,14	10	2-309-16-4-0	

Embalagem industrial sem cabo

Lima faca. Embalagem industrial sem cabo



2-308

			€		
140 mm	2	10,14	10	2-308-14-2-0	
160 mm	0	11,18	10	2-308-16-0-0	
160 mm	1	11,18	10	2-308-16-1-0	
160 mm	2	11,18	10	2-308-16-2-0	

Embalagem industrial sem cabo

Lima quadrada. Embalagem industrial sem cabo



2-303

			€		
140 mm	2	8,90	10	2-303-14-2-0	
160 mm	0	9,76	10	2-303-16-0-0	
160 mm	1	9,76	10	2-303-16-1-0	
160 mm	2	9,76	10	2-303-16-2-0	
160 mm	4	10,14	10	2-303-16-4-0	
180 mm	0	11,18	10	2-303-18-0-0	
180 mm	2	11,18	10	2-303-18-2-0	

Embalagem industrial sem cabo

Jogo de 6 limas de calado + 1 cabo

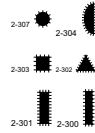

2-470

		€		
140 mm	0	47,92	10	2-470-14-0-0

9-488-02-10	
2-304-14-0-0	
2-300-14-0-0	
2-303-14-0-0	
2-302-14-0-0	
2-301-14-0-0	
2-307-14-0-0	

Conjunto de 6 limas de precisão



2-470-14-2-0

		€		
140 mm	2	46,75	10	2-470-14-2-0

9-488-02-10	
2-304-14-2-0	
2-300-14-2-0	
2-303-14-2-0	
2-302-14-2-0	
2-301-14-2-0	
2-307-14-2-0	

Conjunto de 6 limas de calado



2-470-14-4-0

		€		
140 mm	4	51,03	10	2-470-14-4-0

9-488-02-10	
2-304-14-4-0	
2-300-14-4-0	
2-303-14-4-0, 2-301-14-4-0	
2-302-14-4-0	
2-307-14-4-0	

Conjunto de 6 limas de calado



2-470-16-1-0

		€		
160 mm	1	49,21	10	2-470-16-1-0

9-488-02-10	
2-304-16-1-0	
2-300-16-1-0	
2-303-16-1-0	
2-302-16-1-0	
2-301-16-1-0	
2-307-16-1-0	

Conjunto de 6 limas de calado



2-470-16-2-0

		€		
160 mm	2	50,75	10	2-470-16-2-0

9-488-02-10	
2-304-16-2-0	
2-300-16-2-0	
2-303-16-2-0	
2-302-16-2-0	
2-301-16-2-0	
2-307-16-2-0	

Jogo de 9 limas de calado + 1 cabo



2-471

		€		
160 mm	1	83,52	5	2-471-16-1-0

9-488-02-10	
2-303-16-1-0	
2-304-16-1-0	
2-302-16-1-0	
2-300-16-1-0	
2-308-16-1-0	
2-301-16-1-0	
2-306-16-1-0	
2-305-16-1-0	
2-307-16-1-0	



Jogo de 12 limas de calado + 1 cabo



2-472

		€		
140 mm	0	91,20	5	2-472-14-0-0

2-303-14-0-0, 2-313-14-0-0, 2-309-14-0-0, 2-306-14-0-0

2-300-14-0-0	
2-301-14-0-0	
2-304-14-0-0	
2-302-14-0-0	
2-307-14-0-0	
9-488-02-10	

Conjunto de 12 limas de calado



2-472-14-2-0

		€		
140 mm	2	91,20	5	2-472-14-2-0

2-303-14-2-0	
2-300-14-2-0	
2-301-14-2-0	
2-304-14-2-0	
2-302-14-2-0	
2-313-14-2-0, 2-306-14-2-0	
2-307-14-2-0	
2-308-14-2-0	
9-488-02-10	

Conjunto de 12 limas de calado



2-472-16-0-0

		€		
160 mm	0	98,42	5	2-472-16-0-0

2-303-16-0-0	
2-300-16-0-0	
2-301-16-0-0	
2-304-16-0-0	
2-302-16-0-0	
2-313-16-0-0	
2-307-16-0-0	
2-306-16-0-0	
2-308-16-0-0	
9-488-02-10	

Conjunto de 12 limas de calado



2-472-16-1-0

		€		
160 mm	1	98,42	5	2-472-16-1-0

2-300-16-1-0	
2-301-16-1-0	
2-302-16-1-0	
2-303-16-1-0	
2-304-16-1-0	
2-306-16-1-0	
2-307-16-1-0	
2-308-16-1-0	
2-309-16-2-0	
2-311-16-2-0	
2-313-16-2-0	
9-488-02-10	

Conjunto de 12 limas de calado



2-472-16-2-0

		€		
160 mm	2	98,42	5	2-472-16-2-0

2-303-16-2-0	
2-300-16-2-0	
2-301-16-2-0	
2-311-16-2-0	
2-304-16-2-0	
2-302-16-2-0	
2-313-16-2-0	
2-307-16-2-0	
2-309-16-2-0	
2-306-16-2-0	
2-308-16-2-0	
9-488-02-10	

LIMAS DE DIAMANTE

Limas de precisão diamantadas



2-300-D - 2-304-D

	€		
140 mm	53,89	10	2-300-14-D-1P
160 mm	72,31	10	2-300-16-D-1P
140 mm	53,89	1	2-301-14-D-1P
140 mm	59,30	10	2-302-14-D-1P
160 mm	79,30	10	2-302-16-D-1P
140 mm	53,89	10	2-303-14-D-1P
160 mm	72,31	1	2-303-16-D-1P
140 mm	59,30	10	2-304-14-D-1P
160 mm	79,30	10	2-304-16-D-1P

Limas de precisão diamantadas



2-306-D - 2-308-D

	€		
140 mm	59,30	1	2-306-14-D-1P
140 mm	53,89	10	2-307-14-D-1P
160 mm	72,31	10	2-307-16-D-1P
140 mm	59,30	1	2-308-14-D-1P

Cabo universal para limas de calado



9-488-02

g	€		
5 g	2,54	10	9-488-02-10

Escova de limpeza. Arame de aço



9-469

	€		
110 mm 240 mm	16,46	1	9-469-00-0-0

Arame de aço

Limas de precisão diamantadas



5-600-D - 5-670-D

	€		
215 mm	136,96	10	5-600-21-D-1P
215 mm	135,88	5	5-610-21-D-1P
215 mm	97,03	1	5-630-21-D-1P
215 mm	144,08	1	5-670-21-D-1P

Cabo para limações de motosserra



PH-6604

g	€		
55 g	3,11	15	PH-6604-1P
50 g	1,99	25	PH-6604-25

Cabo de plástico para limas



ergo



9-484...10

	€		
3.2 3.2 mm	1,78	10	9-484-3.2-10
5.2 5.2 mm	1,78	10	9-484-5.2-10

ACESSÓRIOS

Suporte Pansar®



9-462

L	€		
350 mm	56,83	5	9-462-14-0-0

Escova de limpeza. Arame de aço + pelo rijo



9-467

	€		
130 mm 260 mm	43,24	1	9-467-00-0-0

Arame de aço + pelo rijo

Cabo de plástico para limas



ergo



9-484...1P

	€		
3.2 3.2 mm	3,07	10	9-484-3.2-1P
5.2 5.2 mm	3,07	10	9-484-5.2-1P



Cabo ERGO™ para limas de forma rectangular



ergo



9-485...10

			€		
4		4 mm	3,07	10	9-485-04-10
5		5 mm	3,07	10	9-485-05-10
6		6 mm	3,34	10	9-485-06-10
9		9 mm	3,34	10	9-485-09-10
13		13 mm	3,34	10	9-485-13-10

Cabo ERGO™ para limações motosserra



ergo



9-486-C-1P

			€		
3.2		3.2 mm	4,26	10	9-486-C-1P

Cabo ERGO™ para limas de forma rectangular



ergo



9-485...1P

			€		
4		4 mm	3,07	10	9-485-04-1P
5		5 mm	3,07	10	9-485-05-1P
6		6 mm	4,50	20	9-485-06-1P
9		9 mm	4,50	20	9-485-09-1P
13		13 mm	4,50	1	9-485-13-1P

Cabo ERGO™ para limas. Forma redonda, quadrada e triangular



ergo



9-486...10

			€		
4		4 mm	3,34	10	9-486-04-10
5		5 mm	3,34	10	9-486-05-10
7		7 mm	3,35	10	9-486-07-10
8		8 mm	4,49	10	9-486-08-10

Forma redonda, quadrada e triangular

Cabo ERGO™ para limações motosserra



ergo



9-486-C-10

			€		
3.2		3.2 mm	3,19	10	9-486-C-10

Cabo ERGO™ para limas. Forma redonda, quadrada e triangular



ergo



9-486...1P

			€		
4		4 mm	4,50	20	9-486-04-1P
5		5 mm	4,50	20	9-486-05-1P
7		7 mm	4,50	20	9-486-07-1P

Forma redonda, quadrada e triangular



Chaves de bocas



CHAVES AJUSTÁVEIS

Chave crescente, fosfatada. Combinada: chave crescente + chave para tubos

ergo



90

L	mm	€	PC	90
158mm/6"	20 mm	29,11	5	9070
208mm/8"	27 mm	31,61	5	9071
257mm/10"	31 mm	41,16	5	9072
308mm/12"	34 mm	59,86	5	9073

Combinada: chave crescente + chave para tubos

Chave ajustável ERGO™ fosfatada com pega de borracha e porca central, com mandíbula reversível

ergo



90P

L	mm	€	PC	90P
158mm/6"	21 mm	32,59	5	9070 P
208mm/8"	28 mm	34,79	5	9071 P
257mm/10"	33 mm	44,61	5	9072 P
308mm/12"	35 mm	63,33	5	9073 P

Chave crescente, cromada. Combinada: chave crescente + chave para tubos

ergo



90C

L	mm	€	PC	90C
158mm/6"	20 mm	26,36	5	9070C
208mm/8"	27 mm	28,23	5	9071C
257mm/10"	31 mm	36,36	5	9072 C
308mm/12"	34 mm	53,08	3	9073 C

Combinada: chave crescente + chave para tubos

Chaves ajustáveis ERGO™ com pega de borracha e porca central, com mandíbula reversível

ergo



90PC

L	mm	€	PC	90PC
158mm/6"	21 mm	29,05	5	9070 PC
208mm/8"	28 mm	31,11	5	9071 PC
257mm/10"	33 mm	39,06	5	9072 PC
308mm/12"	35 mm	55,77	3	9073 PC

Chave crescente, fosfatada, curta

ergo



9029-9035

L	mm	€	PC	9029-9035
170mm/6"	32 mm	30,52	5	9029
218mm/8"	38 mm	33,17	5	9031
270mm/10"	46 mm	43,27	5	9033
324mm/12"	55 mm	62,72	5	9035

Chave crescente com grande abertura da maxila. Com abertura da maxila extra

ergo



9029C/9031C

L	mm	€	PC	9029C/9031C
170mm/6"	32 mm	35,78	5	9029 C
218mm/8"	38 mm	38,37	5	9031 C

Com abertura da maxila extra

Chave Ajustável Rebaixada. com grande abertura

ergo



9029-T/9031-T

L	mm	€	PC	9029-T/9031-T
170mm/6"	32 mm	35,20	5	9029-T
218mm/8"	38 mm	40,96	5	9031-T

com grande abertura

Chave crescente, abertura maior e maxila reversível

ergo



9031P

L	mm	€	PC	9031P
218mm/8"	39 mm	35,94	5	9031P

Conjunto de 3 chaves ajustáveis da Série 90

ergo



ADJUST3-90

g	€	PC	ADJUST3-90
900 g	91,11	1	ADJUST 3-90

9070, 9071, 9072

Embalagem dupla 9031 e 9029



ergo



ADJUST9031/29

g	€	Icon	Icon
550 g	63,71	3	ADJUST 9031/29

9029, 9031

Chave crescente, fosfatada. Combinada: chave crescente + chave para tubos



80

L	Icon	€	Icon	Icon
110mm/4"	13 mm	22,33	5	8069
155mm/6"	20 mm	23,45	5	8070
205mm/8"	27 mm	25,44	5	8071
255mm/10"	31 mm	33,16	5	8072
305mm/12"	34 mm	48,19	5	8073
380mm/15"	44 mm	78,75	3	8074
455mm/18"	53 mm	123,74	3	8075
110mm/4"	13 mm	21,62	50	8069 IP
155mm/6"	20 mm	22,81	40	8070 IP
205mm/8"	27 mm	24,80	50	8071 IP
255mm/10"	31 mm	32,51	30	8072 IP
305mm/12"	34 mm	47,55	20	8073 IP
380mm/15"	44 mm	78,12	20	8074 IP
455mm/18"	53 mm	123,08	10	8075 IP

Combinada: chave crescente + chave para tubos

Chave crescente, cromada. Combinada: chave crescente + chave para tubos



80C

L	Icon	€	Icon	Icon
110mm/4"	13 mm	16,40	5	8069 C
155mm/6"	20 mm	16,83	5	8070 C
205mm/8"	27 mm	19,13	5	8071 C
255mm/10"	31 mm	23,20	5	8072 C
305mm/12"	34 mm	30,54	5	8073 C
380mm/15"	44 mm	51,31	3	8074 C
455mm/18"	53 mm	79,61	3	8075 C

L	Icon	€	Icon	Icon
110mm/4"	13 mm	15,90	5	8069 C IP
155mm/6"	20 mm	16,31	5	8070 C IP
205mm/8"	27 mm	18,65	5	8071 C IP
255mm/10"	31 mm	22,71	5	8072 C IP
305mm/12"	34 mm	30,04	5	8073 C IP
380mm/15"	44 mm	50,80	3	8074 C IP
455mm/18"	53 mm	79,13	3	8075 C IP

Combinada: chave crescente + chave para tubos

Chave ajustável de grandes dimensões



86/87

L	Icon	€	Icon	Icon
614mm/24"	63 mm	277,02	1	86
770mm/30"	85 mm	282,88	3	87

Conjunto de 3 chaves ajustáveis da Série 80



ADJUST3

g	€	Icon	Icon
810 g	77,58	1	ADJUST 3

8070, 8071, 8072

Peças extra para chaves crescentes. 2= molette e ressort



RPS

Icon	€	Icon	Icon
8069, 8069 C	4,88	1	8069-1
8070, 8070 C, 9070, 9070 C	5,65	1	8070-1
8071, 8071 C, 9071, 9071 C	5,24	1	8071-1

Icon	€	Icon	Icon
8072, 8072 C, 9072, 9072 C	5,44	1	8072-1
8073, 8073 C, 9073, 9073 C	6,28	1	8073-1
8074, 8074 C	10,20	1	8074-1
8075, 8075 C	13,53	1	8075-1
9029, 9029 C, 31	5,99	1	9029-1
9029-T	13,35	1	9029T-1
9031, 9031 C	5,80	1	9031-1
9031-T	13,46	1	9031T-1
9033, 33H	12,66	1	9033-1
9035	14,15	1	9035-1
86	8,06	1	86-1
87	10,12	1	87-1
9031 P	8,40	1	9031 P-1
9070 P, 9070 PC	8,16	1	9070 P-1
9071 P, 9071 PC	7,97	1	9071 P-1
9072 P, 9072 PC	8,77	1	9072 P-1
9073 P, 9073 PC	9,95	1	9073 P-1

2= molette e ressort

Conjuntos de serrilha, perno e mola sobresselentes para as séries 80 e 90 de chaves ajustáveis



RPS2

Icon	g	€	Icon	Icon
8069, 8069 C	3 g	2,97	1	8069-2
8070, 8070 C, 9070, 9070 C, 9070 P, 9070 PC	8 g	3,10	1	8070-2
8071, 8071 C, 9071, 9071 C, 9071 P, 9071 PC	10 g	3,13	1	8071-2
8072, 8072 C, 9072, 9072 C, 9072 P, 9072 PC	16 g	3,43	1	8072-2
8073, 8073 C, 9073, 9073 C, 9073 P, 9073 PC, 9033	25 g	3,77	1	8073-2
8074, 8074 C, 9035	47 g	4,43	1	8074-2
8075, 8075 C	54 g	4,95	1	8075-2
9029, 9029 C, 9029-T, 9031-T, 31, 9031, 9031 C, 9031P	9 g	3,43	1	9029-2
86	125 g	6,78	1	86-2
87	185 g	7,11	1	87-2



Chave ajustável de grandes dimensões - podger



84

↔	👤	€	📦	🐟
405mm/16"	41 mm	37,11	1	84-PODGER

Chave crescente



31

↔	👤	€	📦	🐟
209mm/8"	32 mm	37,25	5	31
209mm/8"	32 mm	35,87	50	31-IP

Chaves de boca fina ajustáveis com mandíbulas de tubo serrilhadas e acabamento fosfatado



31-T

↔	👤	€	📦	🐟
209mm/8"	32 mm	35,87	5	31-T
209mm/8"	32 mm	35,87	50	31-T-IP

Chave inglesa com gancho



33H

↔	👤	€	📦	🐟
254mm/10"	46 mm	66,38	5	33H

Chave Ajustável Lateral Fosfatada. Serviços Pesados



95

↔	👤	€	📦	🐟
257mm/10"	35 mm	48,19	5	9572

Serviços Pesados

Chave Ajustável de parafuso lateral



91C/97C

↔	👤	€	📦	🐟
155mm/6"	21 mm	27,40	5	91C
205mm/8"	29 mm	31,24	5	92C
255mm/10"	34 mm	37,07	5	93C
305mm/12"	39 mm	47,37	5	94C
405mm/16"	48 mm	79,28	1	95C
500mm/20"	60 mm	150,69	1	96C
750mm/30"	77 mm	294,44	1	97C



CHAVES DE BOCAS COMBINADAS

Chave mista offset



111M



↕	€	📦	🐟
5.5 mm	6,39	10	111M-5.5
6 mm	5,81	10	111M-6
7 mm	5,87	10	111M-7
8 mm	6,04	10	111M-8
9 mm	7,21	10	111M-9
10 mm	7,26	10	111M-10
11 mm	7,89	10	111M-11
12 mm	8,33	10	111M-12
13 mm	8,77	10	111M-13
14 mm	9,13	10	111M-14
15 mm	9,46	10	111M-15
16 mm	10,00	10	111M-16
17 mm	10,69	10	111M-17
18 mm	11,27	10	111M-18
19 mm	12,88	10	111M-19
20 mm	13,03	10	111M-20
21 mm	14,89	10	111M-21
22 mm	15,02	5	111M-22
23 mm	15,90	5	111M-23
24 mm	16,63	5	111M-24
25 mm	18,04	5	111M-25
26 mm	21,41	5	111M-26
27 mm	23,55	5	111M-27
28 mm	25,16	5	111M-28
29 mm	25,79	5	111M-29
30 mm	28,69	5	111M-30
32 mm	30,92	5	111M-32
33 mm	33,26	5	111M-33
34 mm	35,79	5	111M-34
36 mm	50,58	1	111M-36
38 mm	59,82	1	111M-38
41 mm	64,22	1	111M-41
46 mm	84,69	1	111M-46
50 mm	95,92	1	111M-50
55 mm	167,26	1	111M-55
60 mm	221,89	1	111M-60
65 mm	295,49	1	111M-65
70 mm	351,24	1	111M-70
75 mm	442,67	1	111M-75
80 mm	510,69	1	111M-80
85 mm	687,01	1	111M-85
90 mm	695,25	1	111M-90
95 mm	697,31	1	111M-95
100 mm	715,85	1	111M-100
5.5 mm	6,80	1	SB111M-5,5
6 mm	7,05	1	SB111M-6
7 mm	7,10	1	SB111M-7
8 mm	7,27	1	SB111M-8
9 mm	8,49	1	SB111M-9
10 mm	8,55	1	SB111M-10
11 mm	9,20	1	SB111M-11
12 mm	9,64	1	SB111M-12
13 mm	10,11	1	SB111M-13
14 mm	10,51	1	SB111M-14
15 mm	10,83	1	SB111M-15

	€		
16 mm	11,64	1	SB111M-16
17 mm	12,14	1	SB111M-17
18 mm	12,71	1	SB111M-18
19 mm	14,41	1	SB111M-19
20 mm	14,52	1	SB111M-20
21 mm	16,49	1	SB111M-21
22 mm	16,61	1	SB111M-22
23 mm	17,54	1	SB111M-23
24 mm	18,32	1	SB111M-24
25 mm	19,77	1	SB111M-25
26 mm	19,25	1	SB111M-26
27 mm	21,55	1	SB111M-27
28 mm	26,58	1	SB111M-28
29 mm	28,79	1	SB111M-29
30 mm	30,83	1	SB111M-30
32 mm	34,31	1	SB111M-32

Chave boca luneta, tipo coto, polegadas





1Z

	€		
3/16 in	7,46	20	1Z-3/16
7/32 in	7,46	20	1Z-7/32
9/32 in	7,18	20	1Z-9/32
5/16 in	4,64	10	1Z-5/16
11/32 in	5,33	10	1Z-11/32
3/8 in	5,33	10	1Z-3/8
7/16 in	5,70	10	1Z-7/16
1/2 in	6,30	10	1Z-1/2
9/16 in	6,67	10	1Z-9/16
5/8 in	7,54	10	1Z-5/8
11/16 in	7,81	10	1Z-11/16
3/4 in	9,01	10	1Z-3/4
13/16 in	10,43	10	1Z-13/16
7/8 in	10,43	10	1Z-7/8
15/16 in	16,59	5	1Z-15/16
1 in	16,83	10	1Z-1

Chave mista offset



111Z

	€		
1/4 in	6,07	5	111Z-1/4
5/16 in	6,27	5	111Z-5/16
3/8 in	7,62	5	111Z-3/8
7/16 in	8,30	5	111Z-7/16
1/2 in	9,18	5	111Z-1/2
9/16 in	9,67	5	111Z-9/16
5/8 in	10,49	5	111Z-5/8
11/16 in	11,10	5	111Z-11/16
3/4 in	13,29	5	111Z-3/4
13/16 in	15,45	5	111Z-13/16
7/8 in	15,71	5	111Z-7/8
15/16 in	17,50	3	111Z-15/16
1 in	18,90	3	111Z-1
1 1/16 in	24,51	5	111Z-1.1/16
1 1/8 in	26,19	5	111Z-1.1/8
1 1/4 in	32,05	5	111Z-1.1/4
1 5/16 in	37,30	5	111Z-1.5/16
1 3/8 in	52,51	1	111Z-1.3/8
1 7/16 in	52,51	1	111Z-1.7/16
1 1/2 in	55,17	1	111Z-1.1/2
1 5/8 in	66,68	1	111Z-1.5/8
1 11/16 in	86,12	1	111Z-1.11/16
1 3/4 in	92,40	1	111Z-1.3/4
1 13/16 in	85,94	1	111Z-1.13/16
1 7/8 in	98,28	1	111Z-1.7/8
2 in	99,62	1	111Z-2
2 1/8 in	175,25	1	111Z-2.1/8
2 1/4 in	175,25	1	111Z-2.1/4
2 3/8 in	242,21	1	111Z-2.3/8
2 1/2 in	300,18	1	111Z-2.1/2
2 5/8 in	300,18	1	111Z-2.5/8
2 3/4 in	319,29	1	111Z-2.3/4
2 7/8 in	387,53	1	111Z-2.7/8
3 in	387,53	1	111Z-3

Chave mista offset



S20

	€		
9	5,83	1	SBS20-9
12	6,92	1	SBS20-12
15	7,83	1	SBS20-15
16	8,38	1	SBS20-16
20	11,54	1	SBS20-20

Conjunto de chaves boca luneta, 5 peças, métrico



111M/SH5

	€		
5	45,64	1	111M/SH5

111M-8, 111M-10, 111M-13, 111M-17, 111M-19

Jogo de chaves combinadas, métrico



111M/SH8

	€		
8	84,26	1	111M/SH8

111M-8, 111M-10, 111M-12, 111M-13, 111M-14, 111M-17, 111M-19, 111M-22

Jogo de chaves combinadas, métrico



111M/SH12

	€		
12	120,02	1	111M/SH12

111M-8, 111M-9, 111M-10, 111M-11, 111M-12, 111M-13, 111M-14, 111M-15, 111M-16, 111M-17, 111M-18, 111M-19



Conjunto de chaves de bocas duplas, métrico



111M/



€



10 94,61 1 111M/S10

111M-8, 111M-9, 111M-10, 111M-11, 111M-12, 111M-13, 111M-14, 111M-17, 111M-19, 111M-22



Jogo de chaves combinadas, métrico



111M/11T



€



11 107,88 1 111M/11T

111M-8, 111M-9, 111M-10, 111M-11, 111M-12, 111M-13, 111M-14, 111M-15, 111M-17, 111M-19, 111M-22



Jogo de chaves combinadas, métrico



111M/14T



€

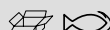

14 199,01 1 111M/14T

111M-6, 111M-8, 111M-9, 111M-10, 111M-13, 111M-14, 111M-15, 111M-17, 111M-19, 111M-22, 111M-24, 111M-27, 111M-30, 111M-32



Jogo de chaves combinadas, métrico



111M/17T



€

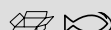

17 172,23 1 111M/17T

111M-6, 111M-7, 111M-8, 111M-9, 111M-10, 111M-11, 111M-12, 111M-13, 111M-14, 111M-15, 111M-16, 111M-17, 111M-18, 111M-19, 111M-20, 111M-21, 111M-22



Jogo de chaves combinadas, métrico



111M/17TL



€



17 221,71 1 111M/17TL

111M-8, 111M-9, 111M-10, 111M-11, 111M-12, 111M-13, 111M-14, 111M-15, 111M-16, 111M-18, 111M-19, 111M-22, 111M-24, 111M-26, 111M-27, 111M-30, 111M-32



Conjunto de chaves boca luneta, métrico



111M/24T



€



24 364,21 1 111M/24T

111M-6, 111M-7, 111M-8, 111M-9, 111M-10, 111M-11, 111M-12, 111M-13, 111M-14, 111M-15, 111M-16, 111M-17, 111M-18, 111M-19, 111M-20, 111M-21, 111M-22, 111M-24, 111M-26, 111M-27, 111M-28, 111M-30, 111M-32, 111M-36



Jogo de chaves combinadas, métrico



111M/26T



€



26 380,62 1 111M/26T

111M-6, 111M-7, 111M-8, 111M-9, 111M-10, 111M-11, 111M-12, 111M-13, 111M-14, 111M-15, 111M-16, 111M-17, 111M-18, 111M-19, 111M-20, 111M-21, 111M-22, 111M-23, 111M-24, 111M-25, 111M-26, 111M-27, 111M-28, 111M-29, 111M-30, 111M-32



Jogos de chaves mistas offset



111Z/



€



8 95,86 1 111Z/8T

111Z-3/8, 111Z-7/16, 111Z-1/2, 111Z-9/16, 111Z-5/8, 111Z-11/16, 111Z-3/4, 111Z-7/8

Conjunto de chaves boca luneta, polegadas



111Z/11T

	€		
11	153,78	1	111Z/11T

111Z-3/8, 111Z-7/16, 111Z-1/2, 111Z-9/16, 111Z-5/8, 111Z-11/16, 111Z-3/4, 111Z-13/16, 111Z-7/8, 111Z-15/16, 111Z-1

Chave mista offset, série longa



11M

	€		
8 mm	11,42	5	11M-8
9 mm	11,42	5	11M-9
10 mm	12,00	5	11M-10
11 mm	12,00	5	11M-11
12 mm	13,73	5	11M-12
13 mm	13,73	5	11M-13
14 mm	16,57	5	11M-14
15 mm	16,57	5	11M-15
16 mm	18,18	5	11M-16
17 mm	18,76	5	11M-17
18 mm	18,89	5	11M-18
19 mm	23,75	5	11M-19
21 mm	23,75	5	11M-21
22 mm	17,81	5	11M-22
24 mm	30,42	5	11M-24
27 mm	39,45	1	11M-27
30 mm	47,73	1	11M-30
32 mm	47,73	1	11M-32
36 mm	61,36	1	11M-36
38 mm	65,02	1	11M-38

Chave boca luneta, série longa polegadas



11Z

	€		
3/8 in	11,41	5	11Z-3/8
7/16 in	11,80	5	11Z-7/16
1/2 in	12,15	5	11Z-1/2
9/16 in	12,58	5	11Z-9/16
5/8 in	15,05	5	11Z-5/8
11/16 in	15,05	5	11Z-11/16
3/4 in	16,85	5	11Z-3/4
13/16 in	17,66	5	11Z-13/16
1 in	37,41	5	11Z-1

Chave mista, Liliput



4020L-M

	€		
3.2 mm	19,59	5	4020L-M-3.2
3.5 mm	19,59	5	4020L-M-3.5
4 mm	18,50	5	4020L-M-4
4.5 mm	18,50	5	4020L-M-4.5
5 mm	18,50	5	4020L-M-5
5.5 mm	18,50	5	4020L-M-5.5

Chave mista offset



1952M

	€		
6 mm	9,18	10	1952M-6
7 mm	9,18	10	1952M-7
8 mm	9,07	10	1952M-8
9 mm	10,20	10	1952M-9
10 mm	10,20	10	1952M-10
11 mm	10,94	10	1952M-11
12 mm	11,56	10	1952M-12
13 mm	12,53	10	1952M-13
14 mm	12,64	10	1952M-14
15 mm	14,96	10	1952M-15

	€		
16 mm	16,18	10	1952M-16
17 mm	16,72	10	1952M-17
18 mm	18,71	10	1952M-18
19 mm	19,61	10	1952M-19
20 mm	20,77	10	1952M-20
21 mm	21,58	10	1952M-21
22 mm	24,20	5	1952M-22
23 mm	26,14	5	1952M-23
24 mm	27,32	5	1952M-24
25 mm	29,16	5	1952M-25
26 mm	29,44	5	1952M-26
27 mm	31,39	5	1952M-27
28 mm	35,79	1	1952M-28
29 mm	38,20	1	1952M-29
30 mm	40,11	1	1952M-30
32 mm	41,94	1	1952M-32
34 mm	54,36	1	1952M-34
36 mm	71,26	1	1952M-36
41 mm	88,59	1	1952M-41
46 mm	142,53	1	1952M-46
50 mm	181,18	1	1952M-50
55 mm	231,37	1	1952M-55
60 mm	352,35	1	1952M-60
65 mm	450,30	1	1952M-65
70 mm	486,21	1	1952M-70
75 mm	550,97	1	1952M-75
80 mm	660,59	1	1952M-80
7 mm	10,36	1	SB1952M-7
8 mm	10,21	1	SB1952M-8
10 mm	11,37	1	SB1952M-10
12 mm	12,72	1	SB1952M-12
13 mm	13,69	1	SB1952M-13
14 mm	13,81	1	SB1952M-14
17 mm	17,87	1	SB1952M-17
19 mm	20,77	1	SB1952M-19
24 mm	28,48	1	SB1952M-24

Chave mista offset



1952Z

	€		
1/4 in	9,68	5	1952Z-1/4
5/16 in	9,83	5	1952Z-5/16
11/32 in	10,45	5	1952Z-11/32
3/8 in	10,98	5	1952Z-3/8
7/16 in	11,92	5	1952Z-7/16
1/2 in	19,46	5	1952Z-1/2
9/16 in	14,51	5	1952Z-9/16
5/8 in	16,48	5	1952Z-5/8
11/16 in	19,42	5	1952Z-11/16
3/4 in	21,23	5	1952Z-3/4
13/16 in	22,71	5	1952Z-13/16
7/8 in	27,25	5	1952Z-7/8
15/16 in	29,03	5	1952Z-15/16
1 in	30,20	1	1952Z-1
1 1/16 in	33,20	1	1952Z-1.1/16
1 1/8 in	39,20	1	1952Z-1.1/8
1 1/4 in	45,02	1	1952Z-1.1/4
1 5/16 in	48,61	1	1952Z-1.5/16
1 3/8 in	88,28	1	1952Z-1.3/8
1 7/16 in	93,60	1	1952Z-1.7/16
1 1/2 in	94,54	1	1952Z-1.1/2
1 5/8 in	113,32	1	1952Z-1.5/8



Chave mista, offset, métrica



PU

	€		
6 mm	7,30	5	PU-6
9 mm	8,84	5	PU-9
14 mm	10,91	5	PU-14
20 mm	16,06	3	PU-20
22 mm	21,50	3	PU-22
24 mm	24,48	3	PU-24

Conjunto de chaves de bocas duplas, offset, métrico



1952M/

	€		
10	128,45	1	1952M/10

1952M-8, 1952M-9, 1952M-10, 1952M-11, 1952M-12, 1952M-13, 1952M-14, 1952M-16, 1952M-17, 1952M-19

Jogo de chaves combinadas, offset, métrico - 8 peças



1952M/SH

	€		
6	79,43	1	1952M/SH6

1952M-8, 1952M-10, 1952M-12, 1952M-13, 1952M-14, 1952M-17

Jogos de chaves mistas offset



1952M/T

	€		
7	109,13	1	1952M/7T

1952M-8, 1952M-10, 1952M-13, 1952M-14, 1952M-17, 1952M-19, 1952M-22

Jogo de chaves combinadas, offset, métrico - 12 peças



1952M/SH12

	€		
12	176,72	1	1952M/SH12

1952M-8, 1952M-9, 1952M-10, 1952M-11, 1952M-12, 1952M-13, 1952M-14, 1952M-15, 1952M-16, 1952M-17, 1952M-18, 1952M-19

Jogo de chaves combinadas, offset, métrico



1952M/14T

	€		
14	286,77	1	1952M/14T

1952M-6, 1952M-8, 1952M-9, 1952M-10, 1952M-13, 1952M-14, 1952M-15, 1952M-17, 1952M-19, 1952M-22, 1952M-24, 1952M-27, 1952M-30, 1952M-32

Jogo de chaves combinadas, offset, métrico



1952M/17T

	€		
17	258,69	1	1952M/17T

1952M-6, 1952M-7, 1952M-8, 1952M-9, 1952M-10, 1952M-11, 1952M-12, 1952M-13, 1952M-14, 1952M-15, 1952M-16, 1952M-17, 1952M-18, 1952M-19, 1952M-20, 1952M-21, 1952M-22

Jogo de chaves combinadas, offset, métrico



1952M/26T

	€		
26	557,38	1	1952M/26T

1952M-6, 1952M-7, 1952M-8, 1952M-9, 1952M-10, 1952M-11, 1952M-12, 1952M-13, 1952M-14, 1952M-15, 1952M-16, 1952M-17, 1952M-18, 1952M-19, 1952M-20, 1952M-21, 1952M-22, 1952M-23, 1952M-24, 1952M-25, 1952M-26, 1952M-27, 1952M-28, 1952M-29, 1952M-30, 1952M-32

Jogos de chaves mistas offset



1952Z/T

	€		
11	179,90	1	1952Z/11T

1952Z-1/4, 1952Z-5/16, 1952Z-3/8, 1952Z-7/16, 1952Z-1/2, 1952Z-9/16, 1952Z-5/8, 1952Z-11/16, 1952Z-3/4, 1952Z-13/16, 1952Z-7/8

CHAVES DE ROQUETE

Chave combinada boca e roquete



1RM

	€		
6 mm	22,55	1	1RM-6
7 mm	22,55	1	1RM-7
8 mm	23,82	1	1RM-8
9 mm	24,12	1	1RM-9
10 mm	25,75	1	1RM-10
11 mm	27,33	1	1RM-11
12 mm	29,35	1	1RM-12
13 mm	30,40	1	1RM-13
14 mm	31,72	1	1RM-14
15 mm	32,61	1	1RM-15
16 mm	35,55	1	1RM-16
17 mm	35,86	1	1RM-17
18 mm	38,80	1	1RM-18
19 mm	39,13	1	1RM-19
21 mm	41,79	1	1RM-21
22 mm	42,15	1	1RM-22
24 mm	45,54	1	1RM-24
27 mm	53,16	1	1RM-27
30 mm	64,30	1	1RM-30
32 mm	69,96	1	1RM-32

Chave mista boca e roquete, em polegadas



1RZ

	€		
1/4 in	25,90	1	1RZ-1/4
5/16 in	26,17	1	1RZ-5/16
11/32 in	22,55	1	1RZ-11/32
3/8 in	27,08	1	1RZ-3/8
7/16 in	29,88	1	1RZ-7/16
1/2 in	33,28	1	1RZ-1/2
9/16 in	34,58	1	1RZ-9/16
5/8 in	38,27	1	1RZ-5/8
11/16 in	40,71	1	1RZ-11/16
3/4 in	44,22	1	1RZ-3/4
7/8 in	48,63	1	1RZ-7/8
15/16 in	58,50	1	1RZ-15/16

em polegadas

Chave mista boca e roquete versão curta, em milímetros



10RM

	€		
8 mm	17,59	1	10RM-8
10 mm	19,79	1	10RM-10
13 mm	22,45	1	10RM-13
14 mm	22,82	1	10RM-14
17 mm	26,54	1	10RM-17
19 mm	29,10	1	10RM-19

em milímetros

Chave boca luneta c/roquete - versão curta, em pol.



10RZ

	€		
5/16 in	19,24	1	10RZ-5/16
3/8 in	20,93	1	10RZ-3/8
7/16 in	21,84	1	10RZ-7/16

	€		
1/2 in	23,46	1	10RZ-1/2
9/16 in	24,67	1	10RZ-9/16
5/8 in	27,70	1	10RZ-5/8
11/16 in	29,12	1	10RZ-11/16
3/4 in	31,50	1	10RZ-3/4

Chave combinada com roquete e cabeça flexível



41RM

	€		
8 mm	22,07	1	41RM-8
10 mm	24,04	1	41RM-10
11 mm	25,27	1	41RM-11
12 mm	27,28	1	41RM-12
13 mm	28,07	1	41RM-13
14 mm	29,43	1	41RM-14
17 mm	33,27	1	41RM-17
19 mm	37,59	1	41RM-19
21 mm	39,20	1	41RM-21

Metric sizes

Chave boca luneta c/roquete e cbç art. de bloqueio. Tamanhos em polegadas



41RZ

	€		
5/16 in	19,80	1	41RZ-5/16
3/8 in	20,95	1	41RZ-3/8
7/16 in	21,66	1	41RZ-7/16
1/2 in	23,68	1	41RZ-1/2
9/16 in	25,01	1	41RZ-9/16
5/8 in	28,08	1	41RZ-5/8
11/16 in	30,08	1	41RZ-11/16
3/4 in	31,32	1	41RZ-3/4
13/16 in	45,30	1	41RZ-13/16
7/8 in	45,30	1	41RZ-7/8



Jogos de chaves combinadas boca e roquete



1RM/

	€		
6	183,46	1	1RM/SH6

1RM-8, 1RM-10, 1RM-12, 1RM-13, 1RM-14, 1RM-17



Jogo de chaves combinadas com roquete



1RM/SH8

	€		
8	262,55	1	1RM/SH8

1RM-8, 1RM-10, 1RM-11, 1RM-12, 1RM-13, 1RM-14, 1RM-17, 1RM-19



Jogo de chaves combinadas com roquete



1RM/SH12

	€		
12	387,58	10	1RM/SH12

1RM-8, 1RM-9, 1RM-10, 1RM-11, 1RM-12, 1RM-13, 1RM-14, 1RM-15, 1RM-16, 1RM-17, 1RM-18, 1RM-19



Conjunto de chaves combinadas boca e roquete



1RM/S5

	€		
5	155,22	10	1RM/S5

1RM-8, 1RM-10, 1RM-13, 1RM-17, 1RM-19



Conjunto de chaves mistas boca e roquete, em polegadas. Tamanhos em polegadas



1RZ/

	€		
8	282,95	1	1RZ/SH8

Tamanhos em polegadas

1RZ-5/16, 1RZ-3/8, 1RZ-7/16, 1RZ-1/2, 1RZ-9/16, 1RZ-5/8, 1RZ-11/16, 1RZ-3/4



Jogo de chaves combinadas de roquete e adaptadores. 8pcs



1RMA/S8

	€		
160 x 283 x 75 mm	139,75	1	1RMA/S8

8pcs

1RMA-13-3/8-SQ, 1RMA-10-1/4-SQ, 1RMA-19-1/2-SQ



1RMA-13-5/16-BIT, 1RMA-10-1/4-BIT



1RM-13, 1RM-10, 1RM-19



Conjunto de chaves mistas boca e roquete, em milímetros



10RM/

	€		
6	143,69	1	10RM/SH6

Metric sizes

10RM-8, 10RM-10, 10RM-13, 10RM-14, 10RM-17, 10RM-19



Conjunto de chaves combinadas boca e roquete. Métrico



41RM/SH8

	€		
8	234,58	10	41RM/SH8

Métrico

41RM-8, 41RM-10, 41RM-11, 41RM-12, 41RM-13, 41RM-14, 41RM-17, 41RM-19



Conjunto de chaves de luneta ajustáveis com roquete



42RM/S12

		€		
229 x 70 x 280 mm	1562 g	342,97	1	42RM/S12

Chave roquete, em milímetros



1320RM

	€		
6-7 mm	31,05	1	1320RM-6-7
8-9 mm	31,48	1	1320RM-8-9
10-11 mm	33,39	1	1320RM-10-11
12-13 mm	35,61	1	1320RM-12-13
14-15 mm	39,41	1	1320RM-14-15
16-17 mm	43,26	1	1320RM-16-17
17-19 mm	44,58	1	1320RM-17-19
18-19 mm	46,55	1	1320RM-18-19
22-24 mm	49,05	1	1320RM-22-24

Chave de roquete, em polegadas.
Tamanhos em polegadas



1320RZ

	€		
1/4-5/16" in	31,05	1	1320RZ-1/4-5/16
5/16-11/32 in	33,69	60	1320RZ-5/16-11/32
3/8-7/16" in	39,57	1	1320RZ-3/8-7/16
1/2-9/16" in	45,27	1	1320RZ-1/2-9/16
5/8-11/16" in	26,11	1	1320RZ-5/8-11/16
3/4-13/16" in	40,60	1	1320RZ-3/4-13/16
3/4-7/8" in	40,60	1	1320RZ-3/4-7/8
7/8-15/16" in	53,73	1	1320RZ-7/8-15/16

Tamanhos em polegadas

Chave de luneta com roquete e cabeça angular.
Tamanhos em polegadas



1321RZ

	€		
3/8-7/16 in	25,37	1	1321RZ-3/8-7/16
1/2-9/16 in	28,59	1	1321RZ-1/2-9/16
5/8-11/16 in	33,10	1	1321RZ-5/8-11/16
3/4x7/8 in	46,80	1	1321RZ-3/4-7/8

Chave de roquete tipo S



1320SRM

	€		
14-19 mm	41,94	1	1320SRM-14-19

Chave de roquete em milímetros



1320RM/

	€		
8	317,35	1	1320RM/SH8

1320RM-6-7, 1320RM-8-9, 1320RM-10-11, 1320RM-12-13, 1320RM-14-15, 1320RM-16-17, 1320RM-18-19, 1320RM-22-24

Conjunto de chave de roquete tipo S



1320SRM/

	€		
29	130,09	1	1320SRM/S29

1320SRM-14-19

1RMA-19-17-HEX, 1RMA-19-16-HEX, 1RMA-19-15-HEX, 1RMA-19-13-HEX, 1RMA-19-9/16-HEX, 1RMA-19-5/8-HEX, 1RMA-19-11/16-HEX, 1RMA-19-1/2-HEX, 1RMA-19-E18-TX, 1RMA-19-E20-TX, 1RMA-19-E16-TX, 1RMA-19-E22-TX, 1RMA-19-1/2-SQ2, 1RMA-14-11-HEX, 1RMA-14-12-HEX, 1RMA-14-E11-TX, 1RMA-14-E12-TX, 1RMA-14-E10-TX, 1RMA-14-E14-TX, 1RMA-14-E8-TX, 1RMA-14-10-HEX, 1RMA-14-7/16-HEX, 1RMA-14-3/8-HEX, 1RMA-14-5/16-HEX, 1RMA-14-8-HEX, 1RMA-14-9-HEX

1RMA-19-1/4-SQ

SBS19-TH22

Caixa com roquete 4 em 1



S4RM

	€		
4x5 6x7 mm	20,85	1	S4RM-4-7
8x9 10x11 mm	23,06	1	S4RM-8-11
12x13 14x15 mm	31,14	1	S4RM-12-15
16x17 18x19 mm	37,52	1	S4RM-16-19
20x21 24x27 mm	72,48	1	S4RM-21-27
30x32 34x36 mm	133,41	1	S4RM-30-36

Jogos chaves roquete 4 em 1



S4RM/

	€		
3	94,49	20	S4RM/3T

S4RM-8-11, S4RM-12-15, S4RM-16-19



Jogo de chaves de roquete com anel 4 em 1



S4RM/4T

		€		
	4	154,46	1	S4RM/4T

S4RM-8-11, S4RM-12-15, S4RM-16-19, S4RM-21-27

Jogos de chaves de roquete com anel 4 em 1



S4RM/5T

		€		
	5	311,27	1	S4RM/5T

S4RM-8-11, S4RM-12-15, S4RM-16-19, S4RM-21-27, S4RM-30-36

Adaptadores de chaves de caixa para chave de roquete



1RMA-SQ

		€		
1/4 in	10 mm	9,72	1	1RMA-10-1/4-SQ
3/8 in	13 mm	10,22	1	1RMA-13-3/8-SQ
1/2 in	19 mm	11,05	1	1RMA-19-1/2-SQ
1/4 in	19 mm	10,81	1	1RMA-19-1/4-SQ

Adaptador de pontas para chave de roquete



1RMA-BIT

		€		
1/4	10 mm	7,63	1	1RMA-10-1/4-BIT
5/16	13 mm	8,37	1	1RMA-13-5/16-BIT
10	13 mm	12,03	1	1RMA-13-10-BIT

Jogo de adaptadores para chaves de roquete. 4 pcs



1RMA/S4

	€		
84 x 100 x 35 mm	38,30	1	1RMA/S4

4 pcs

1RMA-10-1/4-SQ, 1RMA-19-1/2-SQ, 1RMA-13-3/8-SQ

1RMA-10-1/4-BIT

CHAVES DE BOCAS ABERTAS

Chave de bocas duplas



6M

	€		
4x5 mm	5,44	10	6M-4-5
4.5x5.5 mm	6,97	10	6M-4.5-5.5
5x5.5 mm	7,04	10	6M-5-5.5

	€		
5.5x7 mm	5,45	10	6M-5.5-7
6x7 mm	5,45	10	6M-6-7
7x8 mm	5,78	10	6M-7-8
8x9 mm	5,48	10	6M-8-9
8x10 mm	5,89	10	6M-8-10
10x11 mm	5,96	10	6M-10-11
10x13 mm	7,32	10	6M-10-13
12x13 mm	7,25	10	6M-12-13
12x14 mm	7,76	10	6M-12-14
13x14 mm	7,69	10	6M-13-14
13x15 mm	8,53	10	6M-13-15
13x16 mm	9,24	10	6M-13-16
13x17 mm	9,07	10	6M-13-17
14x15 mm	7,69	10	6M-14-15
14x17 mm	8,92	10	6M-14-17
16x17 mm	8,92	10	6M-16-17
16x18 mm	9,76	10	6M-16-18
17x19 mm	10,05	10	6M-17-19
18x19 mm	10,05	10	6M-18-19
19x22 mm	12,16	10	6M-19-22
19x24 mm	12,90	10	6M-19-24
20x22 mm	11,91	10	6M-20-22
21x23 mm	12,98	10	6M-21-23
21x24 mm	14,33	10	6M-21-24
22x24 mm	12,96	10	6M-22-24
24x26 mm	15,08	10	6M-24-26
24x27 mm	15,37	10	6M-24-27
24x30 mm	17,79	5	6M-24-30
25x28 mm	17,52	5	6M-25-28
27x29 mm	20,86	5	6M-27-29
27x30 mm	21,77	5	6M-27-30
27x32 mm	23,82	5	6M-27-32
30x32 mm	23,52	5	6M-30-32
30x36 mm	39,16	5	6M-30-36
32x36 mm	41,17	5	6M-32-36
34x36 mm	43,22	1	6M-34-36
36x41 mm	46,93	1	6M-36-41
38x42 mm	55,80	1	6M-38-42
41x46 mm	66,05	1	6M-41-46
46x50 mm	86,11	1	6M-46-50
4x5 mm	9,59	1	SB6M-4-5
6x7 mm	8,06	1	SB6M-6-7
8x9 mm	7,50	1	SB6M-8-9
10x11 mm	7,97	1	SB6M-10-11
12x13 mm	9,08	1	SB6M-12-13
14x15 mm	9,54	1	SB6M-14-15
16x17 mm	10,57	1	SB6M-16-17
17x19 mm	11,22	1	SB6M-17-19
18x19 mm	11,34	1	SB6M-18-19
20x22 mm	13,60	1	SB6M-20-22
21x23 mm	14,71	1	SB6M-21-23
22x24 mm	14,11	1	SB6M-22-24
24x26 mm	16,72	1	SB6M-24-26
24x27 mm	17,02	1	SB6M-24-27
25x28 mm	18,10	1	SB6M-25-28
27x29 mm	22,00	1	SB6M-27-29
30x32 mm	24,56	1	SB6M-30-32

Chave de bocas duplas



6Z

	€		
1/4x5/16 in	5,59	5	6Z-1/4-5/16
5/16x11/32 in	5,59	5	6Z-5/16-11/32
3/8x7/16 in	6,25	5	6Z-3/8-7/16
7/16x1/2 in	7,47	5	6Z-7/16-1/2
1/2x9/16 in	7,91	5	6Z-1/2-9/16
9/16x5/8 in	7,91	5	6Z-9/16-5/8
19/32x11/16 in	9,92	5	6Z-19/32-11/16
5/8x3/4 in	10,30	5	6Z-5/8-3/4
11/16x3/4 in	10,30	5	6Z-11/16-3/4
3/4x7/8 in	12,28	5	6Z-3/4-7/8
25/32x13/16 in	14,18	5	6Z-25/32-13/16
13/16x7/8 in	12,28	5	6Z-13/16-7/8
7/8x15/16 in	15,88	5	6Z-7/8-15/16
15/16x1 in	15,53	5	6Z-15/16-1
1x1.1/8 in	17,99	1	6Z-1-1.1/8
1.1/16x1.1/4 in	23,83	1	6Z-1.1/16-1.1/4
1.1/4x1.3/8 in	41,36	1	6Z-1.1/4-1.3/8

Chave de bocas duplas, Liliput



1931Z

	L	€		
1/8 in	74 mm	15,52	5	1931Z-1/8
5/32 in	80 mm	10,06	5	1931Z-5/32
3/16 in	80 mm	10,06	5	1931Z-3/16
13/64 in	80 mm	10,06	5	1931Z-13/64
7/32 in	80 mm	10,06	5	1931Z-7/32
15/64x1/4 in	84 mm	17,35	5	1931Z-15/64-1/4
1/4 in	80 mm	10,06	5	1931Z-1/4
9/32 in	90 mm	10,48	5	1931Z-9/32
9/32x5/16 in	94 mm	16,37	5	1931Z-9/32-5/16
5/16 in	90 mm	11,33	5	1931Z-5/16
11/32 in	105 mm	11,75	5	1931Z-11/32
11/32x3/8 in	94 mm	18,45	5	1931Z-11/32-3/8
3/8 in	105 mm	12,17	5	1931Z-3/8
7/16 in	120 mm	12,99	5	1931Z-7/16
1/2 in	120 mm	12,99	5	1931Z-1/2
9/16 in	130 mm	13,85	5	1931Z-9/16
5/8 in	130 mm	15,92	5	1931Z-5/8

Chave de bocas duplas, Liliput



1931M

	€		
4 mm	9,65	5	1931M-4
4.5 mm	9,65	5	1931M-4.5
5 mm	9,65	5	1931M-5
5.5 mm	9,65	5	1931M-5.5
6 mm	9,65	5	1931M-6
7 mm	9,65	5	1931M-7
8 mm	10,06	5	1931M-8
9 mm	10,90	5	1931M-9
10 mm	11,33	5	1931M-10
11 mm	12,17	5	1931M-11
12 mm	12,17	5	1931M-12
13 mm	12,17	5	1931M-13
14 mm	12,99	5	1931M-14
17 mm	17,19	5	1931M-17

Chave de bocas duplas



895M

	L	€		
6x7 mm	96 mm	3,47	10	895M-6-7
8x9 mm	109 mm	3,14	10	895M-8-9
8x10 mm	115 mm	3,14	10	895M-8-10
10x11 mm	124 mm	3,43	10	895M-10-11
10x13 mm	110 mm	3,43	10	895M-10-13
13x17 mm	155 mm	4,12	10	895M-13-17
17x19 mm	172 mm	5,08	10	895M-17-19
19x22 mm	195 mm	6,22	10	895M-19-22
19x24 mm	206 mm	7,12	5	895M-19-24
22x24 mm	220 mm	7,46	5	895M-22-24
24x27 mm	244 mm	9,89	5	895M-24-27
24x30 mm	265 mm	11,74	5	895M-24-30
27x32 mm	270 mm	14,20	5	895M-27-32
30x32 mm	275 mm	14,95	5	895M-30-32
30x36 mm	305 mm	20,02	1	895M-30-36
32x36 mm	307 mm	20,02	1	895M-32-36
36x41 mm	345 mm	27,73	1	895M-36-41
41x46 mm	381 mm	33,74	1	895M-41-46
46x50 mm	420 mm	40,54	1	895M-46-50
50x55 mm	460 mm	53,45	1	895M-50-55
55x60 mm	500 mm	67,42	1	895M-55-60
65x70 mm	580 mm	132,69	1	895M-65-70

Conjunto de chaves de bocas, metrico. recipiente plástico



6M/SH

	€		
8	78,45	1	6M/SH8

recipiente plástico

6M-6-7, 6M-8-9, 6M-10-11, 6M-12-13, 6M-14-15, 6M-16-17, 6M-18-19, 6M-20-22

Jogo de chaves de bocas duplas, métrico. Suporte de plástico



6M/SH12

	€		
12	144,95	1	6M/SH12

Suporte de plástico

6M-6-7, 6M-8-9, 6M-10-11, 6M-12-13, 6M-14-15, 6M-16-17, 6M-18-19, 6M-20-22, 6M-21-23, 6M-24-26, 6M-25-28, 6M-30-32

Conjunto de chaves de bocas, metrico. caixa de cartão



6M/S

	€		
8	63,08	1	6M/S8

caixa de cartão

6M-6-7, 6M-8-9, 6M-10-11, 6M-12-13, 6M-14-15, 6M-16-17, 6M-18-19, 6M-20-22



Jogos de chaves de bocas duplas



6M/

	€		
6	41,81	1	6M/6C

6M-6-7, 6M-8-9, 6M-10-11, 6M-12-13, 6M-14-15, 6M-16-17

Jogo de chaves de bocas duplas, métrico



6M/8C

	€		
8	64,30	1	6M/8C

6M-6-7, 6M-8-9, 6M-10-11, 6M-12-13, 6M-14-15, 6M-16-17, 6M-18-19, 6M-20-22

Jogo de chaves de bocas duplas, métrico



6M/10C

	€		
10	93,07	1	6M/10C

6M-6-7, 6M-8-9, 6M-10-11, 6M-12-13, 6M-14-15, 6M-16-17, 6M-18-19, 6M-20-22, 6M-24-27, 6M-30-32

Jogo de chaves de bocas duplas, métrico



6M/12C

	€		
12	135,38	1	6M/12C

6M-6-7, 6M-8-9, 6M-10-11, 6M-12-13, 6M-14-15, 6M-16-17, 6M-18-19, 6M-20-22, 6M-21-23, 6M-24-27, 6M-25-28, 6M-30-32

Jogo de chaves de bocas duplas



6Z/

	€		
8	74,83	1	6Z/8C

6Z-1/4-5/16, 6Z-3/8-7/16, 6Z-5/16-11/32, 6Z-1/2-9/16, 6Z-19/32-11/16, 6Z-5/8-3/4, 6Z-13/16-7/8, 6Z-15/16-1

Jogos de chaves de bocas duplas, Liliput



1931M/

	€		
10	108,60	1	1931M/10T

1931M-4, 1931M-4.5, 1931M-5, 1931M-5.5, 1931M-6, 1931M-7, 1931M-8, 1931M-9, 1931M-10, 1931M-11

Jogos de chaves de bocas duplas, Liliput



1931Z/

	€		
12	140,40	1	1931Z/12T

1931Z-5/32, 1931Z-9/32, 1931Z-5/16, 1931Z-11/32, 1931Z-3/8, 1931Z-3/16, 1931Z-7/32, 1931Z-1/4, 1931Z-7/16, 1931Z-1/2, 1931Z-5/8, 1931Z-9/16

Jogo de chaves de bocas duplas, Electronica



1933M/

	€		
6	58,57	1	1933M/6T

4x4, 4.5x4.5, 5x5, 5.5x5.5, 6x6, 7x7

Chave magnética com anel



3280M/

	€		
8	16,96	1	3280M

4, 4.5, 5, 5.5, 6, 6.5, 7, 7.5 mm

Chave de porcas ajustáveis de 1/4", de bocas



677-



mm	in	€		
7 mm	1/4 in	32,63	1	677-7
8 mm	1/4 in	32,63	1	677-8
9 mm	1/4 in	32,63	1	677-9
10 mm	1/4 in	32,63	1	677-10
13 mm	1/4 in	32,63	1	677-13
3/8 in	1/4 in	32,28	1	677-3/8

Chave de porcas ajustáveis de 3/8", de bocas



747-



mm	in	€		
10 mm	3/8 in	32,81	1	747-10
11 mm	3/8 in	34,30	1	747-11
12 mm	3/8 in	31,79	1	747-12
13 mm	3/8 in	31,79	1	747-13
14 mm	3/8 in	29,53	1	747-14
15 mm	3/8 in	37,87	1	747-15
16 mm	3/8 in	38,57	1	747-16
17 mm	3/8 in	35,61	1	747-17
18 mm	3/8 in	41,91	1	747-18
19 mm	3/8 in	35,61	1	747-19
20 mm	3/8 in	48,12	1	747-20
21 mm	3/8 in	48,12	1	747-21
22 mm	3/8 in	48,12	1	747-22
23 mm	3/8 in	48,70	1	747-23
24 mm	3/8 in	49,18	1	747-24
25 mm	3/8 in	49,48	1	747-25
26 mm	3/8 in	49,90	1	747-26
27 mm	3/8 in	48,70	1	747-27
28 mm	3/8 in	52,75	1	747-28
30 mm	3/8 in	48,70	1	747-30
32 mm	3/8 in	48,70	1	747-32
34 mm	3/8 in	53,12	1	747-34
36 mm	3/8 in	60,14	1	747-36
40 mm	3/8 in	74,43	1	747-40
41 mm	3/8 in	86,93	1	747-41
42 mm	3/8 in	86,93	1	747-42
46 mm	3/8 in	103,00	1	747-46

mm	in	€		
50 mm	3/8 in	103,00	1	747-50
3/8 in	3/8 in	31,57	1	747-3/8
7/16 in	3/8 in	32,97	1	747-7/16
1/2 in	3/8 in	32,28	1	747-1/2
9/16 in	3/8 in	32,29	1	747-9/16
5/8 in	3/8 in	38,47	1	747-5/8
11/16 in	3/8 in	38,47	1	747-11/16
3/4 in	3/8 in	38,47	1	747-3/4
13/16 in	3/8 in	41,91	1	747-13/16
7/8 in	3/8 in	48,70	1	747-7/8
15/16 in	3/8 in	48,70	1	747-15/16
1 in	3/8 in	48,70	1	747-1
1.1/16 in	3/8 in	48,70	1	747-1.1/16
1.1/8 in	3/8 in	46,92	1	747-1.1/8
1.3/16 in	3/8 in	48,70	1	747-1.3/16
1.1/4 in	3/8 in	48,70	1	747-1.1/4
1.5/16 in	3/8 in	49,90	1	747-1.5/16
1.3/8 in	3/8 in	48,70	1	747-1.3/8
1.7/16 in	3/8 in	60,14	1	747-1.7/16
1.1/2 in	3/8 in	60,14	1	747-1.1/2
1.9/16 in	3/8 in	61,94	1	747-1.9/16
1.5/8 in	3/8 in	80,97	1	747-1.5/8
1.11/16 in	3/8 in	85,15	1	747-1.11/16
1.3/4 in	3/8 in	89,91	1	747-1.3/4
1.13/16 in	3/8 in	97,64	1	747-1.13/16
1.7/8 in	3/8 in	97,64	1	747-1.7/8
1.15/16 in	3/8 in	97,73	1	747-1.15/16
2 in	3/8 in	100,62	1	747-2
2.1/16 in	3/8 in	102,18	1	747-2.1/16
2.1/8 in	3/8 in	129,79	1	747-2.1/8
2.3/16 in	3/8 in	133,36	1	747-2.3/16
2.1/4 in	3/8 in	133,36	1	747-2.1/4
2.5/16 in	3/8 in	133,36	1	747-2.5/16
2.3/8 in	3/8 in	140,17	1	747-2.3/8
2.7/16 in	3/8 in	149,81	1	747-2.7/16
2.1/2 in	3/8 in	149,81	1	747-2.1/2
2.9/16 in	3/8 in	149,81	1	747-2.9/16
2.5/8 in	3/8 in	156,11	1	747-2.5/8
2.3/4 in	3/8 in	156,11	1	747-2.3/4
2.7/8 in	3/8 in	195,77	1	747-2.7/8

Chave de porcas ajustáveis de 1/2", de bocas



787-



mm	in	€		
1.1/16 in	1/2 in	48,70	1	787-1.1/16
1.1/8 in	1/2 in	48,70	1	787-1.1/8
1.3/16 in	1/2 in	54,63	1	787-1.3/16
1.1/4 in	1/2 in	54,63	1	787-1.1/4
1.5/16 in	1/2 in	54,63	1	787-1.5/16
1.3/8 in	1/2 in	59,40	1	787-1.3/8
1.7/16 in	1/2 in	60,59	1	787-1.7/16
1.1/2 in	1/2 in	61,20	1	787-1.1/2
1.5/8 in	1/2 in	67,13	1	787-1.5/8
1.11/16 in	1/2 in	136,67	1	787-1.11/16
1.3/4 in	1/2 in	136,67	1	787-1.3/4

mm	in	€		
1.13/16 in	1/2 in	136,67	1	787-1.13/16
1.7/8 in	1/2 in	148,54	1	787-1.7/8
2 in	1/2 in	148,54	1	787-2
2.1/8 in	1/2 in	166,31	1	787-2.1/8
2.3/16 in	1/2 in	166,31	1	787-2.3/16
2.1/4 in	1/2 in	178,16	1	787-2.1/4
2.3/8 in	1/2 in	190,11	1	787-2.3/8

Chave de boca simple



894M

mm	L	€		
7 mm	78 mm	3,43	10	894M-7
8 mm	94 mm	3,43	10	894M-8
9 mm	100 mm	3,52	10	894M-9
10 mm	106 mm	3,43	10	894M-10
11 mm	112 mm	3,52	10	894M-11
12 mm	125 mm	3,52	10	894M-12
13 mm	125 mm	3,52	10	894M-13
14 mm	140 mm	4,12	10	894M-14
15 mm	140 mm	4,27	10	894M-15
16 mm	140 mm	4,56	10	894M-16
17 mm	158 mm	3,52	10	894M-17
19 mm	171 mm	4,78	10	894M-19
21 mm	195 mm	5,14	5	894M-21
22 mm	195 mm	5,95	5	894M-22
24 mm	216 mm	7,17	5	894M-24
27 mm	240 mm	8,19	5	894M-27
30 mm	262 mm	9,65	5	894M-30
32 mm	274 mm	10,88	5	894M-32
34 mm	274 mm	18,09	1	894M-34
36 mm	303 mm	14,15	5	894M-36
38 mm	305 mm	22,06	1	894M-38
41 mm	343 mm	22,45	1	894M-41
46 mm	378 mm	25,40	1	894M-46
50 mm	413 mm	31,81	1	894M-50
55 mm	457 mm	37,58	1	894M-55
60 mm	492 mm	52,96	1	894M-60
65 mm	528 mm	63,53	1	894M-65
70 mm	573 mm	74,20	1	894M-70
75 mm	608 mm	127,79	1	894M-75
80 mm	644 mm	150,86	1	894M-80
85 mm	690 mm	184,14	1	894M-85
90 mm	690 mm	205,94	1	894M-90
95 mm	850 mm	313,27	1	894M-95
100 mm	1000 mm	319,36	1	894M-100
105 mm	1000 mm	417,14	1	894M-105
110 mm	1000 mm	466,12	1	894M-110
115 mm	1000 mm	528,69	1	894M-115
120 mm	1000 mm	556,07	1	894M-120
125 mm	1000 mm	641,65	1	894M-125
130 mm	1000 mm	664,74	1	894M-130
135 mm	1000 mm	745,28	1	894M-135



Chave de extremidade aberta para andaime métrico com acabamento em fosfato



SC335M

Diagram	L	€	Icons	Code
	17 mm	320 mm	10,17	1 SC335M-17
	19 mm	350 mm	14,78	1 SC335M-19
	22 mm	350 mm	19,95	1 SC335M-22
	24 mm	370 mm	21,76	1 SC335M-24
	27 mm	370 mm	29,65	1 SC335M-27
	30 mm	400 mm	37,05	1 SC335M-30
	32 mm	400 mm	37,96	1 SC335M-32
	36 mm	430 mm	43,13	1 SC335M-36
	41 mm	470 mm	58,34	1 SC335M-41
	46 mm	500 mm	73,63	1 SC335M-46

CHAVE DE LUNETA

Chave de luneta dupla, offset



2M

Diagram	L	€	Icons	Code
	6x7 mm	165 mm	10,38	5 2M-6-7
	8x9 mm	180 mm	11,37	5 2M-8-9
	8x10 mm	180 mm	13,18	5 2M-8-10
	10x11 mm	190 mm	12,03	5 2M-10-11
	10x13 mm	190 mm	15,25	5 2M-10-13
	12x13 mm	210 mm	12,93	5 2M-12-13
	13x17 mm	243 mm	14,11	5 2M-13-17
	14x15 mm	226 mm	13,71	5 2M-14-15
	16x17 mm	246 mm	16,38	5 2M-16-17
	16x18 mm	246 mm	19,57	5 2M-16-18
	17x19 mm	266 mm	19,09	5 2M-17-19
	18x19 mm	266 mm	19,09	5 2M-18-19
	19x22 mm	291 mm	22,57	5 2M-19-22
	20x22 mm	291 mm	23,42	5 2M-20-22
	21x23 mm	306 mm	25,00	5 2M-21-23
	22x24 mm	306 mm	27,27	5 2M-22-24
	24x26 mm	326 mm	30,90	5 2M-24-26
	24x27 mm	326 mm	31,38	5 2M-24-27
	25x28 mm	336 mm	36,04	5 2M-25-28
	27x29 mm	351 mm	37,07	5 2M-27-29
	27x30 mm	351 mm	44,08	5 2M-27-30
	27x32 mm	353 mm	44,08	5 2M-27-32

Diagram	L	€	Icons	Code
	30x32 mm	362 mm	43,95	5 2M-30-32
	32x36 mm	402 mm	64,57	1 2M-32-36
	36x41 mm	438 mm	76,69	1 2M-36-41
	41x46 mm	485 mm	101,37	1 2M-41-46
	46x50 mm	535 mm	125,12	1 2M-46-50

Chave de luneta dupla, offset



ZZ

Diagram	L	€	Icons	Code
	1/4x5/16 in	165 mm	11,85	1 ZZ-1/4-5/16
	5/16x3/8 in	180 mm	11,58	1 ZZ-5/16-3/8
	3/8x7/16 in	190 mm	13,25	1 ZZ-3/8-7/16
	1/2x9/16 in	210 mm	13,15	1 ZZ-1/2-9/16
	9/16x5/8 in	225.8 mm	14,11	1 ZZ-9/16-5/8
	5/8x11/16 in	245.5 mm	16,81	1 ZZ-5/8-11/16
	3/4x7/8 in	290.5 mm	22,57	1 ZZ-3/4-7/8
	13/16x7/8 in	290.5 mm	22,57	1 ZZ-13/16-7/8
	15/16x1 in	325.8 mm	31,08	1 ZZ-15/16-1
	1x1 1/8 in	335.9 mm	36,83	1 ZZ-1-1.1/8
	1 1/16x1 1/4 in	353 mm	40,75	1 ZZ-1.1/16-1.1/4

Chave de luneta dupla



1300Z

Diagram	L	€	Icons	Code
	1/4x5/16 in	156 mm	26,56	1 1300Z-1/4-5/16
	3/8x7/16 in	193 mm	26,56	1 1300Z-3/8-7/16
	1/2x9/16 in	220 mm	29,18	1 1300Z-1/2-9/16
	19/32x11/16 in	258 mm	33,64	1 1300Z-19/32-11/16
	5/8x3/4 in	278 mm	35,83	1 1300Z-5/8-3/4
	25/32x13/16 in	300 mm	49,52	1 1300Z-25/32-13/16
	7/8x15/16 in	334 mm	41,01	1 1300Z-7/8-15/16
	15/16x1 in	352 mm	53,43	1 1300Z-15/16-1
	1x1.1/8 in	380 mm	69,67	1 1300Z-1-1.1/8

Conjunto chaves luneta offset, métricas



2M/S

Diagram	€	Icons	Code
	8	117,86	1 2M/S8

2M-6-7, 2M-8-9, 2M-10-11, 2M-12-13, 2M-14-15, 2M-16-17, 2M-18-19, 2M-20-22

Conjunto chaves luneta offset, métricas



2M/T

Diagram	€	Icons	Code
	8	122,05	1 2M/8T

2M-6-7, 2M-8-9, 2M-10-11, 2M-12-13, 2M-14-15, 2M-16-17, 2M-18-19, 2M-20-22

Jogo de chaves de luneta dupla, métrico



2M/10T

Diagram	€	Icons	Code
	10	180,51	1 2M/10T

2M-6-7, 2M-8-9, 2M-10-11, 2M-12-13, 2M-14-15, 2M-16-17, 2M-18-19, 2M-20-22, 2M-21-23, 2M-24-27

Conjunto de chaves de luneta dupla, offset, métrico



2M/12T

Quantidade	Preço	Unidade	Modelo
12	259,43	1	2M/12T

2M-6-7, 2M-8-9, 2M-10-11, 2M-12-13, 2M-14-15, 2M-16-17, 2M-18-19, 2M-20-22, 2M-21-23, 2M-24-27, 2M-25-28, 2M-30-32

Conjunto chaves luneta offset , polegadas



2Z/T

Quantidade	Preço	Unidade	Modelo
7	108,23	1	2Z/T

2Z-1/4-5/16, 2Z-5/16-3/8, 2Z-3/8-7/16, 2Z-1/2-9/16, 2Z-9/16-5/8, 2Z-5/8-11/16, 2Z-3/4-7/8

Chave de luneta direita



4M

Dimensão	Comprimento	Preço	Quantidade	Modelo
6x7 mm	95 mm	9,75	10	4M-6-7
8x 9 mm	110 mm	10,07	10	4M-8-9
10x11 mm	125 mm	11,19	10	4M-10-11

Dimensão	Comprimento	Preço	Quantidade	Modelo
12x13 mm	140 mm	12,23	10	4M-12-13
14x15 mm	155 mm	13,41	10	4M-14-15
16x17 mm	170 mm	14,42	10	4M-16-17
17x19 mm	170 mm	14,99	10	4M-17-19
18x19 mm	185 mm	14,99	10	4M-18-19
20x22 mm	205 mm	17,31	10	4M-20-22
21x23 mm	225 mm	18,96	5	4M-21-23
24x26 mm	250 mm	21,27	1	4M-24-26
24x27 mm	255 mm	21,27	1	4M-24-27
25x28 mm	275 mm	24,03	1	4M-25-28
27x29 mm	275 mm	28,83	1	4M-27-29
30x32 mm	300 mm	30,30	1	4M-30-32

Chave de luneta dupla, série longa, polegadas



44Z

Dimensão	Comprimento	Preço	Quantidade	Modelo
1/4x5/16 in	197 mm	21,36	10	44Z-1/4-5/16
5/16x3/8 in	238 mm	21,36	10	44Z-5/16-3/8
3/8x7/16 in	284 mm	24,61	10	44Z-3/8-7/16
7/16x1/2 in	326 mm	28,55	10	44Z-7/16-1/2
1/2x9/16 in	358 mm	33,89	10	44Z-1/2-9/16
5/8x3/4 in	401 mm	41,94	5	44Z-5/8-3/4
11/16x3/4 in	401 mm	41,94	5	44Z-11/16-3/4
11/16x13/16 in	410 mm	52,62	5	44Z-11/16-13/16

Chave de luneta curva



1943M

Dimensão	Comprimento	Preço	Quantidade	Modelo
11x13 mm	150 mm	27,99	1	1943M-11-13
13x15 mm	185 mm	29,82	1	1943M-13-15
13x17 mm	185 mm	31,48	1	1943M-13-17
14x17 mm	185 mm	32,09	1	1943M-14-17
15x17 mm	185 mm	32,41	1	1943M-15-17
19x22 mm	235 mm	34,34	1	1943M-19-22

Chave tubular em meia-lua, polegadas



1943Z

Dimensão	Comprimento	Preço	Quantidade	Modelo
5/16x3/8 in	153 mm	30,52	1	1943Z-5/16-3/8
7/16x1/2 in	153 mm	30,52	1	1943Z-7/16-1/2
9/16x5/8 in	186 mm	32,00	1	1943Z-9/16-5/8
5/8x3/4 in	233 mm	32,00	1	1943Z-5/8-3/4
11/16x13/16 in	233 mm	35,92	1	1943Z-11/16-13/16

Jogos de chaves de luneta direita



4M/T

Quantidade	Preço	Unidade	Modelo
10	178,83	1	4M/10T

4M-6-7, 4M-8-9, 4M-10-11, 4M-12-13, 4M-14-15, 4M-16-17, 4M-18-19, 4M-20-22, 4M-24-27, 4M-30-32

Conjunto chaves luneta planas, métrica



4M/C

Quantidade	Preço	Unidade	Modelo
10	161,00	1	4M/10C

4M-6-7, 4M-8-9, 4M-10-11, 4M-12-13, 4M-14-15, 4M-16-17, 4M-18-19, 4M-20-22, 4M-21-23, 4M-24-27



Jogo de chaves de boca, métrico



4M/12C

Quantidade	Preço	Ícones	Modelo
12	216,17	€ [Ícones]	4M/12C

4M-6-7, 4M-8-9, 4M-10-11, 4M-12-13, 4M-14-15, 4M-16-17, 4M-18-19, 4M-20-22, 4M-21-23, 4M-24-27, 4M-25-28, 4M-30-32

Conjunto 8 chaves luneta planas



4M/

Quantidade	Preço	Ícones	Modelo
8	120,17	€ [Ícones]	4M/8

4M-6-7, 4M-8-9, 4M-10-11, 4M-12-13, 4M-14-15, 4M-16-17, 4M-18-19, 4M-20-22

CHAVE DE LUNETA ABERTA

Chave de luneta aberta



1949M

Dimensões	Comprimento (L)	Preço	Ícones	Modelo
8x 9 mm	140 mm	23,21	[Ícones]	1949M-8-9
10x11 mm	150 mm	23,21	[Ícones]	1949M-10-11
10x12 mm	150 mm	24,09	[Ícones]	1949M-10-12

Dimensões	Comprimento (L)	Preço	Ícones	Modelo
12x13 mm	170 mm	24,81	[Ícones]	1949M-12-13
12x14 mm	170 mm	26,03	[Ícones]	1949M-12-14
14x15 mm	170 mm	26,03	[Ícones]	1949M-14-15
14x17 mm	200 mm	26,03	[Ícones]	1949M-14-17
17x19 mm	210 mm	35,57	[Ícones]	1949M-17-19
19x22 mm	220 mm	35,57	[Ícones]	1949M-19-22
22x24 mm	235 mm	40,71	[Ícones]	1949M-22-24
24x27 mm	255 mm	51,46	[Ícones]	1949M-24-27
30x32 mm	280 mm	63,70	[Ícones]	1949M-30-32

Chave de luneta aberta



1949Z

Dimensões	Comprimento (L)	Preço	Ícones	Modelo
3/8x7/16 in	150 mm	25,01	[Ícones]	1949Z-3/8-7/16
1/2x9/16 in	170 mm	28,08	[Ícones]	1949Z-1/2-9/16
5/8x3/4 in	210 mm	31,46	[Ícones]	1949Z-5/8-3/4
3/4x7/8 in	220 mm	33,95	[Ícones]	1949Z-3/4-7/8
1x1 1/8 in	255 mm	56,66	[Ícones]	1949Z-1-1.1/8

Chave de porcas ajustável de 1/4"



679-

Dimensões	Preço	Ícones	Modelo
7 mm	45,02	[Ícones]	679-7
8 mm	45,02	[Ícones]	679-8
9 mm	45,97	[Ícones]	679-9
10 mm	50,06	[Ícones]	679-10
11 mm	45,02	[Ícones]	679-11
12 mm	50,47	[Ícones]	679-12
13 mm	50,71	[Ícones]	679-13
14 mm	54,60	[Ícones]	679-14
3/8 in	42,86	[Ícones]	679-3/8
7/16 in	42,86	[Ícones]	679-7/16
1/2 in	42,86	[Ícones]	679-1/2
9/16 in	42,86	[Ícones]	679-9/16

Chave de porcas ajustável de 3/8"



749-

Dimensões	Preço	Ícones	Modelo
10 mm	15,66	[Ícones]	749-10
11 mm	15,66	[Ícones]	749-11
13 mm	4,53	[Ícones]	749-13
14 mm	17,00	[Ícones]	749-14
15 mm	57,76	[Ícones]	749-15
16 mm	51,20	[Ícones]	749-16
17 mm	64,45	[Ícones]	749-17
18 mm	51,20	[Ícones]	749-18
19 mm	64,45	[Ícones]	749-19
20 mm	53,58	[Ícones]	749-20
21 mm	65,78	[Ícones]	749-21
22 mm	65,78	[Ícones]	749-22
23 mm	58,95	[Ícones]	749-23
24 mm	59,72	[Ícones]	749-24
25 mm	60,14	[Ícones]	749-25
26 mm	74,51	[Ícones]	749-26
27 mm	73,51	[Ícones]	749-27
3/8 in	50,00	[Ícones]	749-3/8
7/16 in	50,00	[Ícones]	749-7/16
1/2 in	50,91	[Ícones]	749-1/2
9/16 in	53,73	[Ícones]	749-9/16
5/8 in	53,95	[Ícones]	749-5/8
11/16 in	53,95	[Ícones]	749-11/16
3/4 in	53,95	[Ícones]	749-3/4
13/16 in	53,95	[Ícones]	749-13/16
7/8 in	53,46	[Ícones]	749-7/8
15/16 in	54,78	[Ícones]	749-15/16
1 in	54,78	[Ícones]	749-1
1.1/16 in	54,78	[Ícones]	749-1.1/16
1.1/8 in	54,78	[Ícones]	749-1.1/8
1.3/16 in	59,87	[Ícones]	749-1.3/16
1.1/4 in	63,21	[Ícones]	749-1.1/4
1.5/16 in	81,86	[Ícones]	749-1.5/16
1.3/8 in	84,70	[Ícones]	749-1.3/8
1.7/16 in	86,37	[Ícones]	749-1.7/16
1.1/2 in	100,50	[Ícones]	749-1.1/2
1.9/16 in	102,49	[Ícones]	749-1.9/16
1.5/8 in	106,71	[Ícones]	749-1.5/8
1.11/16 in	106,71	[Ícones]	749-1.11/16
1.3/4 in	120,52	[Ícones]	749-1.3/4
1.13/16 in	123,63	[Ícones]	749-1.13/16
1.7/8 in	123,63	[Ícones]	749-1.7/8
1.15/16 in	132,68	[Ícones]	749-1.15/16
2 in	137,20	[Ícones]	749-2
2.1/8 in	143,40	[Ícones]	749-2.1/8
2.3/16 in	143,40	[Ícones]	749-2.3/16
2.1/4 in	143,40	[Ícones]	749-2.1/4
2.3/8 in	150,20	[Ícones]	749-2.3/8
2.5/8 in	167,69	[Ícones]	749-2.5/8
2.3/4 in	167,69	[Ícones]	749-2.3/4
3.1/8 in	239,94	[Ícones]	749-3.1/8

Chave de porcas ajustável de 1/2"



789-

🔧		€	📦	🐟
28 mm	1/2 in	63,12	1	789-28
30 mm	1/2 in	80,13	1	789-30
32 mm	1/2 in	84,14	1	789-32
34 mm	1/2 in	67,87	1	789-34
36 mm	1/2 in	90,84	1	789-36
38 mm	1/2 in	75,02	1	789-38
40 mm	1/2 in	84,55	1	789-40
41 mm	1/2 in	111,02	1	789-41
42 mm	1/2 in	84,55	1	789-42
46 mm	1/2 in	123,58	1	789-46
50 mm	1/2 in	110,15	1	789-50
1.1/8 in	1/2 in	54,78	1	789-1.1/8
1.1/4 in	1/2 in	59,54	1	789-1.1/4
1.5/16 in	1/2 in	63,12	1	789-1.5/16
1.3/8 in	1/2 in	63,12	1	789-1.3/8
1.7/16 in	1/2 in	68,47	1	789-1.7/16
1.1/2 in	1/2 in	68,47	1	789-1.1/2
1.9/16 in	1/2 in	78,58	1	789-1.9/16
1.5/8 in	1/2 in	78,58	1	789-1.5/8
1.3/4 in	1/2 in	91,08	1	789-1.3/4
1.13/16 in	1/2 in	91,08	1	789-1.13/16
2 in	1/2 in	98,83	1	789-2
2.1/4 in	1/2 in	110,75	1	789-2.1/4
2.5/16 in	1/2 in	133,36	1	789-2.5/16
2.3/8 in	1/2 in	138,13	1	789-2.3/8

Cabeça de chave ajustável 3/8"



1950MZ

🔧	€	📦	🐟
0-29/0-1.1/8 in	77,02	1	1950MZ-3/8

CHAVES DE BOCAS

Chave de luneta de pancada



7444SG-M

🔧	€	📦	🐟
24 mm	36,28	1	7444SG-M-24
27 mm	39,46	1	7444SG-M-27
30 mm	40,66	1	7444SG-M-30
32 mm	40,66	1	7444SG-M-32
34 mm	59,56	1	7444SG-M-34
36 mm	51,91	1	7444SG-M-36
38 mm	61,09	1	7444SG-M-38
41 mm	66,28	1	7444SG-M-41
42 mm	66,28	1	7444SG-M-42
46 mm	72,64	1	7444SG-M-46
50 mm	81,67	1	7444SG-M-50
55 mm	93,40	1	7444SG-M-55
60 mm	98,45	1	7444SG-M-60
65 mm	131,94	1	7444SG-M-65
70 mm	152,58	1	7444SG-M-70
75 mm	163,84	1	7444SG-M-75
80 mm	217,98	1	7444SG-M-80
85 mm	291,91	1	7444SG-M-85
90 mm	381,65	1	7444SG-M-90
95 mm	421,68	1	7444SG-M-95
100 mm	474,87	1	7444SG-M-100
105 mm	535,71	1	7444SG-M-105
110 mm	590,67	1	7444SG-M-110
115 mm	679,84	1	7444SG-M-115
120 mm	989,69	1	7444SG-M-120
125 mm	1.280,31	1	7444SG-M-125
130 mm	1.392,43	1	7444SG-M-130
135 mm	1.436,30	1	7444SG-M-135
140 mm	1.628,91	1	7444SG-M-140
145 mm	2.261,60	1	7444SG-M-145
150 mm	2.380,87	1	7444SG-M-150
155 mm	2.585,00	1	7444SG-M-155
160 mm	2.739,29	1	7444SG-M-160
165 mm	2.909,95	1	7444SG-M-165
170 mm	3.198,45	1	7444SG-M-170
175 mm	3.431,08	1	7444SG-M-175

Chave Luneta Pancada polegadas



7444SG-Z

🔧	€	📦	🐟
1 1/16 in	43,41	1	7444SG-Z-1.1/16
1 1/8 in	44,73	1	7444SG-Z-1.1/8
1 3/16 in	44,73	1	7444SG-Z-1.3/16

🔧	€	📦	🐟
1 1/4 in	44,73	1	7444SG-Z-1.1/4
1 5/16 in	65,54	1	7444SG-Z-1.5/16
1 3/8 in	65,54	1	7444SG-Z-1.3/8
1 7/16 in	65,54	1	7444SG-Z-1.7/16
1 1/2 in	67,19	1	7444SG-Z-1.1/2
1 5/8 in	72,90	1	7444SG-Z-1.5/8
1 11/16 in	72,90	1	7444SG-Z-1.11/16
1 3/4 in	79,91	1	7444SG-Z-1.3/4
1 13/16 in	79,91	1	7444SG-Z-1.13/16
1 7/8 in	89,83	1	7444SG-Z-1.7/8
2 in	89,83	1	7444SG-Z-2
2 1/16 in	102,75	1	7444SG-Z-2.1/16
2 1/8 in	108,32	1	7444SG-Z-2.1/8
2 3/16 in	108,32	1	7444SG-Z-2.3/16
2 1/4 in	108,32	1	7444SG-Z-2.1/4
2 3/8 in	133,79	1	7444SG-Z-2.3/8
2 9/16 in	167,85	1	7444SG-Z-2.9/16
2 5/8 in	167,85	1	7444SG-Z-2.5/8
2 3/4 in	167,85	1	7444SG-Z-2.3/4
3 in	180,23	1	7444SG-Z-3
3 1/8 in	285,36	1	7444SG-Z-3.1/8
3 3/8 in	321,10	1	7444SG-Z-3.3/8
3 1/2 in	419,82	1	7444SG-Z-3.1/2
3 3/4 in	463,86	1	7444SG-Z-3.3/4
3 7/8 in	522,38	1	7444SG-Z-3.7/8
4 in	589,27	1	7444SG-Z-4
4 1/8 in	589,27	1	7444SG-Z-4.1/8
4 1/2 in	747,83	1	7444SG-Z-4.1/2

Chave de impacto



133SGM

🔧	€	📦	🐟
27 mm	28,92	1	133SGM-27
30 mm	33,95	1	133SGM-30
32 mm	36,01	1	133SGM-32
36 mm	46,40	1	133SGM-36
41 mm	56,88	1	133SGM-41
46 mm	76,60	1	133SGM-46
50 mm	87,27	1	133SGM-50
55 mm	101,79	1	133SGM-55
60 mm	113,12	1	133SGM-60
65 mm	141,75	1	133SGM-65
70 mm	182,61	1	133SGM-70
75 mm	195,53	1	133SGM-75
80 mm	255,35	1	133SGM-80
85 mm	268,27	1	133SGM-85
90 mm	342,57	1	133SGM-90
95 mm	360,37	1	133SGM-95
100 mm	552,66	1	133SGM-100
105 mm	617,31	1	133SGM-105
110 mm	673,88	1	133SGM-110
115 mm	788,62	1	133SGM-115
120 mm	801,55	1	133SGM-120



Chave de Luneta de pancada 45°



315M

	€		
27 mm	75,44	1	315M-27
30 mm	76,87	1	315M-30
32 mm	75,44	1	315M-32
36 mm	104,43	1	315M-36
41 mm	107,36	1	315M-41
46 mm	139,28	1	315M-46
50 mm	156,67	1	315M-50
55 mm	179,89	1	315M-55
60 mm	232,10	1	315M-60
65 mm	264,01	1	315M-65
70 mm	307,54	1	315M-70
75 mm	319,16	1	315M-75
80 mm	368,46	1	315M-80

Chave Luneta de Pancada 45° Polegadas



315Z

	€		
1.1/16 in	69,63	1	315Z-1.1/16
1.1/8 in	69,63	1	315Z-1.1/8
1.3/16 in	72,54	1	315Z-1.3/16
1.1/4 in	75,44	1	315Z-1.1/4
1.5/16 in	78,34	1	315Z-1.5/16
1.3/8 in	98,63	1	315Z-1.3/8
1.7/16 in	92,59	1	315Z-1.7/16
1.1/2 in	94,21	1	315Z-1.1/2
1.5/8 in	110,26	1	315Z-1.5/8
1.11/16 in	113,17	1	315Z-1.11/16
1.3/4 in	121,86	1	315Z-1.3/4
1.13/16 in	124,75	1	315Z-1.13/16
1.7/8 in	133,46	1	315Z-1.7/8
1.15/16 in	136,34	1	315Z-1.15/16
2 mm	136,34	1	315Z-2
2.1/16 in	139,28	1	315Z-2.1/16
2.1/8 in	140,63	1	315Z-2.1/8
2.3/16 in	152,36	1	315Z-2.3/16
2.1/4 in	159,57	1	315Z-2.1/4
2.5/16 in	162,47	1	315Z-2.5/16
2.3/8 in	168,29	1	315Z-2.3/8
2.1/2 in	205,99	1	315Z-2.1/2
2.9/16 in	211,80	1	315Z-2.9/16
2.5/8 in	214,71	1	315Z-2.5/8

	€		
2.3/4 in	214,71	1	315Z-2.3/4
2.7/8 in	255,32	1	315Z-2.7/8
2.15/16 in	258,21	1	315Z-2.15/16
3 mm	264,01	1	315Z-3
3.1/8 in	269,82	1	315Z-3.1/8

Chave de luneta curva para trabalhos pesados



310M

	€		
24 mm	56,13	1	310M-24
27 mm	56,13	1	310M-27
30 mm	56,13	1	310M-30
32 mm	59,59	1	310M-32
36 mm	68,16	1	310M-36
38 mm	82,01	1	310M-38
41 mm	83,76	1	310M-41
46 mm	93,39	1	310M-46
50 mm	112,45	1	310M-50
55 mm	125,86	1	310M-55
60 mm	154,83	1	310M-60
65 mm	175,07	1	310M-65
70 mm	190,84	1	310M-70
75 mm	208,17	1	310M-75
80 mm	228,69	1	310M-80
85 mm	246,05	1	310M-85
90 mm	488,93	1	310M-90
95 mm	529,93	1	310M-95

Cabo tubular



R310

	€		
24-30 mm	19 mm	42,83	1 R310-0
32-41 mm	22 mm	48,30	1 R310-1
46-55 mm	25 mm	71,58	1 R310-2
60-95 mm	30 mm	91,48	1 R310-3

CHAVES DE CAIXA

Chaves duplas de cachimbo



28M

	€		
6 mm	6 mm	14,75	5 28M-6
7 mm	7 mm	15,36	5 28M-7
8 mm	8 mm	12,64	5 28M-8
9 mm	9 mm	12,52	5 28M-9
10 mm	10 mm	13,21	5 28M-10
11 mm	11 mm	13,80	5 28M-11
12 mm	12 mm	14,63	5 28M-12
13 mm	13 mm	15,71	5 28M-13
14 mm	14 mm	18,00	5 28M-14
15 mm	15 mm	19,07	5 28M-15
16 mm	16 mm	20,11	5 28M-16
17 mm	17 mm	20,93	5 28M-17
18 mm	18 mm	25,25	3 28M-18
19 mm	19 mm	26,65	3 28M-19
20 mm	20 mm	28,56	3 28M-20
21 mm	21 mm	31,05	3 28M-21
22 mm	22 mm	36,06	3 28M-22
23 mm	23 mm	37,55	3 28M-23
24 mm	24 mm	39,80	3 28M-24
25 mm	25 mm	45,42	3 28M-25
26 mm	26 mm	49,33	3 28M-26
27 mm	27 mm	53,87	3 28M-27
28 mm	28 mm	62,03	1 28M-28
29 mm	29 mm	70,73	1 28M-29
30 mm	30 mm	80,27	1 28M-30
32 mm	32 mm	95,67	1 28M-32
6 mm	6 mm	11,65	10 SB28M-6
7 mm	7 mm	12,10	10 SB28M-7
8 mm	8 mm	12,65	10 SB28M-8
9 mm	9 mm	13,10	10 SB28M-9
10 mm	10 mm	13,79	10 SB28M-10
11 mm	11 mm	14,54	10 SB28M-11
12 mm	12 mm	15,39	10 SB28M-12
13 mm	13 mm	16,26	10 SB28M-13
14 mm	14 mm	19,05	10 SB28M-14
15 mm	15 mm	20,13	10 SB28M-15
16 mm	16 mm	21,20	5 SB28M-16
17 mm	17 mm	21,37	5 SB28M-17
18 mm	18 mm	26,43	5 SB28M-18
19 mm	19 mm	27,86	5 SB28M-19
20 mm	20 mm	29,79	4 SB28M-20
21 mm	21 mm	32,32	4 SB28M-21
22 mm	22 mm	37,45	4 SB28M-22
23 mm	23 mm	38,94	4 SB28M-23
24 mm	24 mm	41,23	4 SB28M-24

Chaves de Cachimbo, Milímetros hexagonal x hexagonal



29M

Ø	€	Icon 1	Icon 2
6 mm	14,75	5	29M-6
7 mm	15,36	5	29M-7
8 mm	13,22	5	29M-8
9 mm	13,13	5	29M-9
10 mm	13,21	5	29M-10
11 mm	13,71	5	29M-11
12 mm	14,85	5	29M-12
13 mm	15,40	5	29M-13
14 mm	18,00	5	29M-14
15 mm	19,07	5	29M-15
16 mm	20,11	5	29M-16
17 mm	20,29	5	29M-17
18 mm	25,25	3	29M-18
19 mm	26,65	3	29M-19
20 mm	28,56	3	29M-20
21 mm	31,05	3	29M-21
22 mm	36,06	3	29M-22
23 mm	37,55	3	29M-23
24 mm	39,80	3	29M-24
25 mm	45,42	3	29M-25
26 mm	49,33	3	29M-26
27 mm	53,87	3	29M-27
28 mm	62,03	1	29M-28
29 mm	70,73	1	29M-29
30 mm	80,27	1	29M-30
32 mm	95,67	1	29M-32

hexagonal x hexagonal

Jogos de chaves duplas de cachimbo



28M/

Icon 1	€	Icon 2	Icon 3
8	145,69	1	28M/8

28M-8, 28M-10, 28M-11, 28M-13, 28M-16, 28M-17, 28M-18, 28M-19

Jogo de chaves de caixa dupla



28M/11

Icon 1	€	Icon 2	Icon 3
11	200,05	1	28M/11

28M-8, 28M-9, 28M-10, 28M-11, 28M-13, 28M-12, 28M-14, 28M-15, 28M-17, 28M-19, 28M-22

Jogo de chaves de caixa dupla



28M/12

Icon 1	€	Icon 2	Icon 3
12	209,34	1	28M/12

28M-8, 28M-9, 28M-10, 28M-11, 28M-12, 28M-13, 28M-14, 28M-15, 28M-16, 28M-17, 28M-18, 28M-19

Jogo de chaves de caixa dupla



28M/15

Icon 1	€	Icon 2	Icon 3
15	316,26	1	28M/15

28M-8, 28M-9, 28M-10, 28M-11, 28M-12, 28M-13, 28M-14, 28M-15, 28M-16, 28M-17, 28M-18, 28M-19, 28M-21, 28M-22, 28M-24

Jogo Chaves Duplas de Cachimbo



29M/

Icon 1	€	Icon 2	Icon 3
8	158,79	1	29M/8

29M-8, 29M-10, 29M-12, 29M-13, 29M-14, 29M-17, 29M-19, 29M-22

Jogo de chaves de caixa dupla



29M/10

Icon 1	€	Icon 2	Icon 3
10	178,12	1	29M/10

29M-8, 29M-10, 29M-11, 29M-12, 29M-13, 29M-14, 29M-16, 29M-17, 29M-18, 29M-19

Conjunto de chaves de caixa dupla



29M/14

Icon 1	€	Icon 2	Icon 3
14	309,50	1	29M/14

29M-11, 29M-12, 29M-13, 29M-14, 29M-8, 29M-9, 29M-10, 29M-16, 29M-17, 29M-21, 29M-22, 29M-19, 29M-24, 29M-23



Chave tubular



1936M

Ø	€	📦	🐟
6x7 mm	6,01	50	1936M-6-7
8x9 mm	6,96	5	1936M-8-9
8x10 mm	8,16	30	1936M-8-10
10x11 mm	8,16	25	1936M-10-11
10x13 mm	8,91	25	1936M-10-13
12x13 mm	8,91	25	1936M-12-13
13x17 mm	10,37	20	1936M-13-17
14x15 mm	9,41	20	1936M-14-15
14x17 mm	10,21	15	1936M-14-17
16x17 mm	10,21	15	1936M-16-17
17x19 mm	12,18	10	1936M-17-19
18x19 mm	12,18	10	1936M-18-19
19x22 mm	13,42	8	1936M-19-22
20x22 mm	13,55	8	1936M-20-22
21x23 mm	15,52	8	1936M-21-23
22x24 mm	16,41	5	1936M-22-24
24x26 mm	17,26	5	1936M-24-26
24x27 mm	17,26	5	1936M-24-27
25x28 mm	19,02	5	1936M-25-28
30x32 mm	22,35	1	1936M-30-32
30x34 mm	34,37	4	1936M-30-34
36x41 mm	34,63	4	1936M-36-41
46x50 mm	68,96	2	1936M-46-50

Chaves Tubulares Milímetros



27M

Ø	€	📦	🐟
6x7 mm	13,27	10	27M-6-7
8x9 mm	13,41	10	27M-8-9
10x11 mm	14,24	10	27M-10-11
12x13 mm	16,82	10	27M-12-13
13x17* mm	22,41	10	27M-13-17
14x15 mm	18,80	10	27M-14-15
16x17* mm	21,81	10	27M-16-17
16x18* mm	23,19	10	27M-16-18
18x19* mm	26,05	10	27M-18-19
20x22* mm	29,72	10	27M-20-22
21x23* mm	33,05	5	27M-21-23
21x24* mm	34,52	5	27M-21-24
24x26* mm	35,30	5	27M-24-26

BAHCO

Ø	€	📦	🐟
24x27* mm	35,92	5	27M-24-27
25x28* mm	40,60	5	27M-25-28
27x29* mm	46,37	5	27M-27-29
30x32* mm	51,96	5	27M-30-32
6x7 mm	14,42	10	SB27M-6-7
8x9 mm	14,56	10	SB27M-8-9
10x11 mm	15,39	10	SB27M-10-11
12x13 mm	18,00	10	SB27M-12-13
14x15 mm	19,95	10	SB27M-14-15
16x17* mm	22,99	10	SB27M-16-17
18x19* mm	27,22	10	SB27M-18-19
20x22* mm	30,84	10	SB27M-20-22
21x23* mm	34,18	5	SB27M-21-23
24x26* mm	37,94	5	SB27M-24-26

Jogos de chaves tubulares



1936M/

🔑	€	📦	🐟
7	105,29	1	1936M/7

1936M-8-9, 1936M-10-11, 1936M-12-13, 1936M-14-15, 1936M-16-17, 1936M-18-19, 1936M-20-22
26S-610

Jogo de chaves de luneta, métrico



1936M/12

🔑	€	📦	🐟
12	185,35	1	1936M/12

1936M-6-7, 1936M-8-9, 1936M-10-11, 1936M-12-13, 1936M-14-15, 1936M-16-17, 1936M-18-19, 1936M-20-22, 1936M-21-23, 1936M-24-27, 1936M-25-28, 1936M-30-32
26S-610, 26S-1216, 26S-16

Jogo de Chaves Tubulares métricas



27M/T

🔑	€	📦	🐟
8	158,28	1	27M/8T

27M-6-7, 27M-8-9, 27M-10-11, 27M-12-13, 27M-14-15, 27M-16-17, 27M-18-19, 27M-20-22

Jogo de chaves de caixa dupla, métrico



27M/12T

🔑	€	📦	🐟
12	321,27	1	27M/12T

27M-6-7, 27M-8-9, 27M-10-11, 27M-12-13, 27M-14-15, 27M-16-17, 27M-18-19, 27M-20-22, 27M-21-23, 27M-24-26, 27M-25-28, 27M-30-32

Jogo Chaves Tubulares



27M/

🔑	€	📦	🐟
6	98,35	1	27M/6

27M-6-7, 27M-8-9, 27M-10-11, 27M-12-13, 27M-14-15, 27M-16-17

Jogo de chaves de caixa dupla, métrico



27M/8

	€		
8	154,09	1	27M/8

27M-6-7, 27M-8-9, 27M-10-11, 27M-12-13, 27M-14-15, 27M-16-17, 27M-18-19, 27M-20-22



Jogo de chaves de caixa dupla, métrico



27M/10

	€		
10	222,42	1	27M/10

27M-6-7, 27M-8-9, 27M-10-11, 27M-12-13, 27M-14-15, 27M-16-17, 27M-18-19, 27M-20-22, 27M-21-23, 27M-24-26



Jogo de chaves de caixa dupla, métrico



27M/12

	€		
12	315,00	1	27M/12

27M-6-7, 27M-8-9, 27M-10-11, 27M-12-13, 27M-14-15, 27M-16-17, 27M-18-19, 27M-20-22, 27M-21-23, 27M-24-26, 27M-25-28, 27M-30-32



Passador escalonado



26S

	€		
6 8 10 mm	11,34	10	26S-610
12 14 mm	26,48	8	26S-1216
16 mm	7,55	5	26S-16

Chaves tubulares duplas, articuladas



4040M

	€		
6x7 mm	38,95	1	4040M-6-7
8x9 mm	39,89	1	4040M-8-9
10x11 mm	40,76	1	4040M-10-11
10x13 mm	45,27	1	4040M-10-13
12x13 mm	42,45	1	4040M-12-13
13x17 mm	44,25	1	4040M-13-17
14x15 mm	44,50	1	4040M-14-15
16x17 mm	48,56	1	4040M-16-17
16x18 mm	50,02	1	4040M-16-18
18x19 mm	55,34	1	4040M-18-19
20x22 mm	65,74	1	4040M-20-22
21x23 mm	68,49	1	4040M-21-23

Chave tubular dupla articulada



4040Z

	€		
3/8x7/16 in	39,35	1	4040Z-3/8-7/16
1/2x9/16 in	43,70	1	4040Z-1/2-9/16
5/8x11/16 in	46,58	1	4040Z-5/8-11/16
5/8x3/4 in	49,72	1	4040Z-5/8-3/4
13/16x7/8 in	57,12	1	4040Z-13/16-7/8

Chaves tubulares duplas articuladas, métrico



4040M/S6

	€		
6	283,48	1	4040M/S6

4040M-8-9, 4040M-10-11, 4040M-12-13, 4040M-14-15, 4040M-16-17, 4040M-18-19



Jogos de chaves tubulares duplas articuladas



4040M/6T

	€		
6	267,07	1	4040M/6T

4040M-8-9, 4040M-10-11, 4040M-12-13, 4040M-14-15, 4040M-16-17, 4040M-18-19



CHAVES MULTIFUNÇÕES

5 em 1 chave para quadro eléctrico



MK5

	€		
97x25 mm	27,48	1	MK5

PROFILES: Square: 5,6,7-8mm Triangular: 9mm Two-way-key: 3-5mm



9 em 1 chave para quadro Electrico



MK9

Diagram	€	Icons	Quantity	Model
			1	MK9

95x95 mm **41,89**

Square: 5,6,7,8,9-10mm Triangular:7,8-9,10-11mm Two-way-key: 3-5mm Half-moon: 6mm

CHAVES DE BOCAS DE GANCHO

Chave de gancho para porcas com furos laterais



4106

Diagram	€	Icons	Quantity	Model

19-50 mm	27,36	10	4106-19-50
32-75 mm	39,88	25	4106-32-75
50-120 mm	40,80	25	4106-50-120
115-165 mm	39,42	25	4106-115-165
150-230 mm	88,11	10	4106-150-230

Chave de gancho para porcas com furos laterais



40B

Diagram	€	Icons	Quantity	Model

19-50 mm	24,23	25	40B-19-50
32-75 mm	35,47	25	40B-32-75
50-120 mm	44,73	20	40B-50-120
115-165 mm	60,81	25	40B-115-165
150-230 mm	61,83	10	40B-150-230

Chave com esporões ajustáveis



4307/4310

Diagram	€	Icons	Quantity	Model

10-50 mm	76,55	1	4307
22-100 mm	103,45	1	4310

Pino de substituição para chaves de gancho de pinos ajustáveis



40B-SP

Diagram	€	Icons	Quantity	Model

40B-19-50	3,61	1	40B-19-50-SP
40B-32-75	3,61	1	40B-32-75-SP
40B-50-120	4,27	1	40B-50-120-SP
40B-115-165	4,27	1	40B-115-165-SP



Chaves de caixa e roquetes



CONJUNTOS DE CHAVES DE CAIXA

Jogo de chave de caixa 1/4", 1/2". Chaves mistas, 91 peças



S910



€



110 x 320 x 375 mm

218,36

2

S910

Chaves mistas, 91 peças

Conjunto de chaves de caixa com chaves de boca e aperto combinadas, chaves em L sextavadas e pontas - 96 peças



S95



€



110 x 320 x 375 mm

235,09

2

S95

Jogo de chave de caixa 1/4", 1/2". Chaves mistas, 94 peças



S87+7



€



110 x 430 x 375 mm

262,65

2

S87+7

Chaves mistas, 94 peças

Jogo de chave de caixa 1/4", 1/2". Chaves mistas, 106 peças



S106



€



110 x 430 x 375 mm

305,91

2

S106

Chaves mistas, 106 peças

Jogo de chaves 1/4" - 1/2", com chaves combinadas, 103 pcs



S103



€



110 x 375 x 430 mm

289,07

2

S103

Jogo de chaves de caixa 1/4" e 1/2", 108 Peças



S108



€



110 x 430 x 375 mm

306,94

2

S108

Conjunto de chaves de caixa 1/2+1/4' com outras ferramentas, 81peças



S81MIX



€



110 x 430 x 375 mm

221,45

2

S81MIX

Jogo Caixa 1/4", 1/2" 41 peças



S410



€



110 x 320 x 375 mm

126,69

2

S410

Conjunto chaves de caixa 1/2+1/4', 77peças



S800



€



110 x 375 x 430 mm

290,56

2

S800

Conjunto de chaves de caixa quadradas de 1/4" e 1/2" com perfil sextavado no sistema métrico e roquete de cabeça rotativa - 79 peças



SW79

100 x 215 x 370 mm € 175,10 4 SW79

Conjunto chaves de caixa, 1/4', 3/8', 1/2', 138peças



S138

110 x 375 x 430 mm € 324,45 2 S138

Jogo de chaves 1/4", 10 pcs



S0810L

35 x 85 x 160 mm € 31,84 20 S0810L

Jogo de chaves de caixa 1/4" e 1/2", 56 Peças. Chaves de caixas bi-sextavadas



S560

100 x 215 x 375 mm € 118,45 4 S560

Chaves de caixas bi-sextavadas

1/4' - 3/8' - 1/2' Conjunto de Tomadas de Condução Quadrada com Perfil Metric Hex com Chaves de Engrenagem - 137 Pcs



S137

105 x 370 x 430 mm € 418,85 2 S137

Conjunto chaves de caixa 1/4". 25 peças



SL25

35 x 85 x 160 mm € 42,83 20 SL25

25 peças

Conjunto de chaves de caixa quadradas de 1/4" e 3/8" com perfil sextavado no sistema métrico e roquete de cabeça rotativa - 91 peças



SW91

100 x 215 x 370 mm € 190,55 4 SW91

Conjunto de chaves de caixa longas e chaves de caixa quadradas de 1/4" e 1/2" com perfil sextavado no sistema métrico e conjunto de chaves combinadas - 92 peças



S910AF

110 x 320 x 370 mm € 218,36 2 S910AF

92 peças

SBS81

SBS61

Conjunto chaves de caixa 1/4"



SBSL25

55 x 80 x 165 mm € 46,23 5 SBSL25



Jogo Caixa 1/4", com Dynamic Drive-Perfil
™ 24 peças. 24 peças



SL24



35 x 85 x 160 mm € 43,21 1 SL24

24 peças

Jogo de chave de caixa 1/4", 29 peças.
29 peças



S290



70 x 160 x 280 mm € 71,58 6 S290

29 peças

Conjunto de chaves de caixa quadradas
de 1/4" com perfil sextavado no sistema
métrico e roquete de cabeça rotativa - 65
peças



SW65



70 x 160 x 280 mm € 92,70 6 SW65

Jogo de chaves 1/4", padrão e profundas.
37 pcs



SL25L

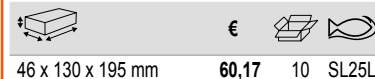

46 x 130 x 195 mm € 60,17 10 SL25L

Jogo de chave de caixa 1/4", 46 peças.
46 peças



S460



100 x 215 x 375 mm € 110,91 6 S460

46 peças

Conjunto de chaves de caixa de 1/4". 25
peças. Tamanhos em polegadas.



SL25AF



35 x 85 x 165 mm € 42,83 20 SL25AF

Jogo de chave de caixa 1/4", 16 peças.
16 peças



S160



70 x 160 x 280 mm € 49,44 6 S160

16 peças

Conjunto de chaves de caixa quadradas
de 1/4" com perfil sextavado no sistema
métrico e roquete de cabeça fina - 65
peças



SL65



70 x 160 x 280 mm € 86,52 6 SL65

Jogo de Chaves de Caixa 1/4" Polegadas
16 peças. 16 peças, tamanhos em
polegadas.



S160AF



70 x 160 x 280 mm € 49,44 6 S160AF

16 peças, tamanhos em polegadas.

BAHCO

Jogo de chaves de caixa, 12 peças. Caixa metálica



6712R

	€		
31 x 110 x 178 mm	125,40	1	6712R

Caixa metálica

6700SM-4, 6700SM-5, 6700SM-5.5, 6700SM-6, 6700SM-7, 6700SM-8, 6700SM-10, 6700SM-11, 6700SM-13	
6950	
6960, 6962	

Jogo de chaves de caixa, 12 peças. Caixa metálica



6712RN

	€		
31 x 108 x 178 mm	120,37	1	6712RN

Caixa metálica

6700SM-4, 6700SM-5, 6700SM-5.5, 6700SM-6, 6700SM-7, 6700SM-8, 6700SM-10, 6700SM-11, 6700SM-13	
6960, 6962	
6950RN	

Jogo de chaves de caixa, 15 peças. Caixa metálica



A6716DM

	€		
35 x 111 x 223 mm	153,56	1	A6716DM

Caixa metálica

A6700DM-5.5, A6700DM-6, A6700DM-7, A6700DM-8, A6700DM-9, A6700DM-10, A6700DM-11, A6700DM-12, A6700DM-13, A6700DM-14	
6956	
6962	
6966	
6954	
6950	

Jogo de chaves de caixa, 16 peças. caixa metálica



6715MGS

	€		
34 x 113 x 223 mm	166,88	1	6715MGS

caixa metálica

SB6700SM-4, 6700SM-4.5, 6700SM-5, 6700SM-5.5, 6700SM-6, 6700SM-7, 6700SM-8, 6700SM-9, 6700SM-10, 6700SM-11, 6700SM-13	
6954	
6950RN	
6956	
6966	
6962	

Conjunto de chaves de caixa 1/4'



6719MHR

	€		
50 x 110 x 220 mm	179,64	1	6719MHR

6700SM-4, 6700SM-4.5, 6700SM-5.5, 6700SM-5, 6700SM-6, 6700SM-7, 6700SM-8, 6700SM-9, 6700SM-10, 6700SM-11, 6700SM-12, 6700SM-13, 6700SM-14	
6950RN	
6960, 6962	
6954	
6956	
6966	

Conjunto de chaves de caixa 1/4'



6729MHR

	€		
50 x 110 x 220 mm	189,76	1	6729MHR

6700SM-4, 6700SM-5, 6700SM-6, 6700SM-7, 6700SM-8, 6700SM-9, 6700SM-10, 6700SM-11, 6700SM-13, 6700SM-14	
6950RN	
6960, 6962	
6966	
6956	
6973A	
59S/PH1, 59S/PH2, 59S/PH3	
59S/PZ1, 59S/PZ2, 59S/PZ3	
59S/0.6-4.5, 59S/0.8-5.5, 59S/1.2-6.5	
59S/H3, 59S/H4, 59S/H5, 59S/H6	



Conjunto de chaves de caixa 1/4'



6729MHP

	€		
50 x 110 x 220 mm	193,09	1	6729MHP

6700SM-4, 6700SM-5, 6700SM-6, 6700SM-7, 6700SM-8, 6700SM-9, 6700SM-10, 6700SM-11, 6700SM-13, 6700SM-14		
6950		
6960, 6962		
6966		
6956		
6973A		
59S/0.6-4.5, 59S/0.8-5.5, 59S/1.2-6.5		
59S/PZ1, 59S/PZ2, 59S/PZ3		
59S/PH1, 59S/PH2, 59S/PH3		
59S/H3, 59S/H4, 59S/H5, 59S/H6		

Conjunto de chaves de caixa 1/4'



6717MBP

	€		
50 x 110 x 220 mm	173,99	1	6717MBP

A6700DM-5, A6700DM-5.5, A6700DM-6, A6700DM-7, A6700DM-8, A6700DM-9, A6700DM-10, A6700DM-11, A6700DM-12, A6700DM-13, A6700DM-14		
6950		
6960, 6962		
6954		
6966		
6956		

Conjunto de chaves de caixa 1/4'



6730MBP

	€		
50 x 110 x 220 mm	197,59	1	6730MBP

A6700DM-5, A6700DM-5.5, A6700DM-6, A6700DM-7, A6700DM-8, A6700DM-9, A6700DM-10, A6700DM-11, A6700DM-12, A6700DM-13, A6700DM-14		
6950		
6960, 6962		
6954		
6966		
6956		
6973A		
59S/0.6-4.5, 59S/1.2-6.5, 59S/0.8-5.5		
59S/PH1, 59S/PH2, 59S/PH3		
59S/PZ1, 59S/PZ2, 59S/PZ3		
59S/H3, 59S/H4, 59S/H5, 59S/H6		

Jogo de chaves de caixa, 17 peças. Caixa metálica



6719SM

	€		
41 x 113 x 223 mm	170,20	1	6719SM

6700SM-4, 6700SM-4.5, 6700SM-5, 6700SM-5.5, 6700SM-6, 6700SM-7, 6700SM-8, 6700SM-9, 6700SM-10, 6700SM-11, 6700SM-12, 6700SM-13		
6954		
6950		
6956		
6966		
6962		

Jogo de chaves de caixa, 20 peças. Caixa metálica



6715MG

	€		
35 x 111 x 223 mm	205,49	1	6715MG

6700SM-4, 6700SM-4.5, 6700SM-5, 6700SM-5.5, 6700SM-6, 6700SM-7, 6700SM-8, 6700SM-9, 6700SM-10, 6700SM-11, 6700SM-12, 6700SM-13, 6700SM-14		
6954		
6958		
6956		
6962, 6960		
6966		
6950RN		

Jogo de chaves de caixa, 21 peças. Caixa metálica



6721NM

	€		
41 x 113 x 223 mm	278,06	1	6721NM

6700SM-4, 6700SM-4.5, 6700SM-5, 6700SM-5.5, 6700SM-6, 6700SM-7, 6700SM-8, 6700SM-9, 6700SM-10, 6700SM-11, 6700SM-12, 6700SM-13, 6700SM-14		
6954		
6951		
6956		
6950		
6962, 6960		
6966		
6958		

Jogo de chaves de caixa, 27 peças. Caixa metálica



6722M

41 x 113 x 223 mm € 226,83 1 6722M

Caixa metálica

6700SM-4, 6700SM-5, 6700SM-6, 6700SM-7, 6700SM-8, 6700SM-9, 6700SM-10, 6700SM-11, 6700SM-13, 6700SM-14	
6954	
6956	
6950	
6966	
6960, 6962	
6972H	
59S/H3, 59S/H4, 59S/H5, 59S/H6	
59S/PH1, 59S/PH2, 59S/PH3	

Jogo de chaves de caixa, 27 peças. Caixa metálica



6715GE

31 x 113 x 223 mm € 223,49 1 6715GE

Caixa metálica

6700SM-4, 6700SM-5, 6700SM-6, 6700SM-7, 6700SM-8, 6700SM-9, 6700SM-10, 6700SM-11, 6700SM-13, 6700SM-14	
6956	
6950RN	
6954	
6966	
6960, 6962	
6972H	
59S/H3, 59S/H4, 59S/H5, 59S/H6	
59S/PH1, 59S/PH2, 59S/PH3	

Jogo de chaves de caixa, 29 peças. Caixa metálica



6715PZ

41 x 113 x 223 mm € 255,22 1 6715PZ

Caixa metálica

6700SM-4, 6700SM-4.5, 6700SM-5, 6700SM-5.5, 6700SM-6, 6700SM-7, 6700SM-8, 6700SM-9, 6700SM-10, 6700SM-11, 6700SM-12, 6700SM-13	
6956	
6950	
6954	
6962, 6960	
6966	
6709F-4.5, 6709F-5.5, 6709F-8	
6709M-3, 6709M-4, 6709M-5, 6709M-6, 6709M-8	
6709PZ-1, 6709PZ-3, 6709PZ-2	

Jogo de chaves de caixa, 29 peças. Caixa metálica



6715GJ

50 x 113 x 223 mm € 256,16 1 6715GJ

Caixa metálica

6700SM-4, 6700SM-4.5, 6700SM-5, 6700SM-5.5, 6700SM-6, 6700SM-7, 6700SM-8, 6700SM-9, 6700SM-10, 6700SM-11, 6700SM-12, 6700SM-13	
6956	
6962, 6960	
6709F-4.5, 6709F-5.5, 6709F-8	
6709M-5, 6709M-6, 6709M-8, 6709M-4, 6709M-3	
6954	
6950	
6966	
6709PH-1, 6709PH-2, 6709PH-3	

Jogo de chaves de caixa, 33 peças. Caixa metálica



6720NM

43 x 114 x 351 mm € 311,37 1 6720NM

Caixa metálica

6700SM-4, 6700SM-4.5, 6700SM-5, 6700SM-5.5, 6700SM-6, 6700SM-7, 6700SM-8, 6700SM-9, 6700SM-10, 6700SM-11, 6700SM-12, 6700SM-13, 6700SM-14	
1931M-4, 1931M-4.5, 1931M-9, 1931M-10, 1931M-11, 1931M-14, 1931M-13, 1931M-12, 1931M-7, 1931M-8, 1931M-6, 1931M-5.5, 1931M-5	
6954	
6950	
6956	
221 D	
73721-3-80	
6966	
6962	

Jogo de chaves de caixa, 15 peças. Caixa metálica



A6716DZ

41 x 113 x 223 mm € 165,38 1 A6716DZ

Caixa metálica

A6700DZ-3/16, A6700DZ-7/32, A6700DZ-1/4, A6700DZ-9/32, A6700DZ-5/16, A6700DZ-11/32, A6700DZ-3/8, A6700DZ-7/16, A6700DZ-1/2, A6700DZ-9/16	
6956	
6962	
6966	
6954	
6950	



Conjuntos de chaves de caixa, 1/4", 18 peças, em polegadas. Caixa metálica



A6718DZ

		€		
41 x 113 x 223 mm	1185 g	181,95	1	A6718DZ

Caixa metálica

6950	
6951	
6956	
6954	
6958	
6960, 6962	
6966	
A6700DZ-3/16, A6700DZ-7/32, A6700DZ-1/4, A6700DZ-9/32, A6700DZ-5/16, A6700DZ-11/32, A6700DZ-3/8, A6700DZ-7/16, A6700DZ-1/2, A6700DZ-9/16	

Jogo de chaves de caixa, 19 peças. caixa metálica



6821NZ

	€		
50 x 113 x 223 mm	269,96	1	6821NZ

caixa metálica

6700SZ-1/4, 6700SZ-11/32, 6700SZ-1/2, 6700SZ-3/16, 6700SZ-5/32, 6700SZ-7/32, 6700SZ-9/32, 6700SZ-5/16, 6700SZ-3/8, 6700SZ-7/16, 6700SZ-9/16	
6954	
6958	
6950	
6956	
6960, 6962	
6966	
6951	

Jogo de chaves de caixa, 25 peças. Caixa metálica



6715MZ

	€		
40 x 126 x 230 mm	206,86	1	6715MZ

Caixa metálica

6700SM-4, 6700SM-4.5, 6700SM-5, 6700SM-5.5, 6700SM-6, 6700SM-8, 6700SM-9, 6700SM-10, 6700SM-11, 6700SM-13	
6700SZ-7/32, 6700SZ-3/16, 6700SZ-1/4, 6700SZ-9/32, 6700SZ-5/16, 6700SZ-11/32, 6700SZ-3/8, 6700SZ-7/16, 6700SZ-1/2	
6954	
6950	
6956	
6966	
6962	

Conjunto de 9 peças de 1/4" Square Drive Deep Socket para o Parafuso de Cabeça Metric e Polegadas Hex



A6709MZ/9

	€		
46 x 130 x 195 mm	201,37	1	A6709MZ/9

A6709M-2.5, A6709M-3, A6709M-4, A6709M-5, A6709M-6	
A6709Z-1/8, A6709Z-9/64, A6709Z-5/32, A6709Z-3/16	
SPAR-CASE-A6	

Jogo de 13 chaves de caixa e extensor com cabo. Chave de caixas bi-sextavada 6700SM em RAIL-187



6729SM

	€		
25 x 55 x 190 mm	79,67	1	6729SM

Chave de caixas bi-sextavada 6700SM em RAIL-187

6700SM-4, 6700SM-4.5, 6700SM-5, 6700SM-5.5, 6700SM-6, 6700SM-7, 6700SM-8, 6700SM-9, 6700SM-10, 6700SM-11, 6700SM-12, 6700SM-13, 6700SM-14	
6956	

Jogo de 7 chaves de caixa e extensor com cabo. Chave de caixas bi-sextavada 6700SM em RAIL-187



6729SZ

	€		
25 x 55 x 190 mm	53,26	1	6729SZ

Chave de caixas bi-sextavada 6700SM em RAIL-187

6700SZ-1/4, 6700SZ-11/32, 6700SZ-1/2, 6700SZ-3/16, 6700SZ-7/32, 6700SZ-3/8, 6700SZ-7/16	
6956	

Conjunto de chaves de caixa 1/4" em rail



6713MH

	€		
13	68,64	1	6713MH

6700SM-4, 6700SM-4.5, 6700SM-5, 6700SM-5.5, 6700SM-6, 6700SM-7, 6700SM-8, 6700SM-9, 6700SM-10, 6700SM-11, 6700SM-12, 6700SM-13, 6700SM-14	
---	--

Conjunto de chaves de caixa 1/4' em rail



6708DMB



€



8

94,59 1 6708DMB

A6800DM-6, A6800DM-7, A6800DM-8,
A6800DM-9, A6800DM-10,
A6800DM-11, A6800DM-12,
A6800DM-13



Conjunto de chaves de caixa 1/4' em rail



6711MB



€



11

59,75 1 6711MB

A6700DM-5, A6700DM-5.5,
A6700DM-6, A6700DM-7, A6700DM-8,
A6700DM-9, A6700DM-10,
A6700DM-11, A6700DM-12,
A6700DM-13, A6700DM-14



Conjunto de chaves de caixa 1/4' em rail



6706TE



€



6

47,00 1 6706TE

6700TORX-E4, 6700TORX-E5,
6700TORX-E6, 6700TORX-E7,
6700TORX-E8, 6700TORX-E10



Jogo de ferramentas para refrigeração.
Refrigeração



R6725MK



€



26 x 105 x 175 mm

259,10

1

R6725MK

Refrigeração

6700SM-7, 6700SM-8, 6700SM-10

6954

R6967

R6810M-3,4, R6810M-4, R6810M-4,5,
R6810M-5, R6810M-6, R6810M-7,
R6810M-8, R6810M-9, R6810M-10

6966

R6950

6962

R6964A

Jogo de ferramentas para refrigeração.
Refrigeração.



R6725ZK



€



48 x 115 x 225 mm

248,84

1

R6725ZK

Refrigeração.

6700SZ-1/4, 6700SZ-5/16, 6700SZ-
11/32, 6700SZ-3/8, 6700SZ-7/16,
6700SZ-1/2

6954

R6967

R6950

6962

R6810M-6

R6964A

6966

R6810Z-3/16, R6810Z-7/32,
R6810Z-1/4, R6810Z-5/16, R6810Z-3/8

R6822Z

Jogo de chaves 3/8", 14 pcs



S1214L



€



49 x 152 x 280 mm

58,25

10

S1214L

Jogo de chave de caixa 1/4" e 3/8", 33
peças. 34 peças



S330



€



70 x 160 x 280 mm

78,26

6

S330

34 peças

Jogo de chaves 1/4" e 3/8", 53 pcs



S330L



€



100 x 215 x 375 mm

114,01

4

S330L



Jogo de chaves de caixa 3/8"
38 peças. 38 peças



S380

	€		
100 x 215 x 375 mm	113,16	4	S380

38 peças

Conjunto de chaves de caixa 1/4" e 3/8" -
34 peças



SL34

	€		
70 x 160 x 280 mm	83,32	6	SL34

JOGO CAIXA COM FURO PASSAGEM
1/4" 14 peças



S140T

	€		
65 x 160 x 280 mm	70,90	1	S140T

SBS19-THR

SBS19-TH75

SBS19-TH10, SBS19-TH11, SBS19-TH12,
SBS19-TH13, SBS19-TH14, SBS19-TH15,
SBS19-TH16, SBS19-TH17, SBS19-TH18,
SBS19-TH19, SBS19-TH21, SBS19-TH22,
SBS19-TH24

SBS19-TH20

KIT ROQUETE FURO PASSAGEM



S140T-R

	€		
121 x 280 x 220 mm	43,26	10	S140T-R

SBS19-THR

1RMA-19-3/8-SQ

1RMA-19-1/2-SQ

JOGO CAIXA COM FURO PASSAGEM
1/4" 53 peças



S530T

	€		
90 x 205 x 370 mm	196,41	4	S530T

Jogo Chaves Caixa Polegadas 1/4",
3/8" 34 peças. 34 peças, tamanhos em
polegadas



S330AF

	€		
70 x 160 x 280 mm	78,26	6	S330AF

34 peças, tamanhos em polegadas

Jogo de chaves de caixa. Chaves de
caixas bi-sextavadas, tamanhos métricos.



A7435DME

	€		
40 x 150 x 500 mm	330,41	1	A7435DME

Chaves de caixas bi-sextavadas, tamanhos métricos.

A7400DM-9, A7400DM-10,
A7400DM-11, A7400DM-12,
A7400DM-13, A7400DM-14,
A7400DM-15, A7400DM-16,
A7400DM-17, A7400DM-18,
A7400DM-19, A7400DM-20,
A7400DM-21, A7400DM-22

7755-3/8

7754

7760, 7762, 7761

7758

7752

7766

Jogo de chaves de caixa 3/8 com
roquete ERGO™. Chaves de caixas bi-
sextavadas, tamanhos métricos.



A7440DME

	€		
50 x 115 x 312 mm	212,59	1	A7440DME

Chaves de caixas bi-sextavadas, tamanhos métricos.

7755-3/8

7758

7761

A7400DM-9, A7400DM-12,
A7400DM-13, A7400DM-14,
A7400DM-15, A7400DM-16,
A7400DM-17, A7400DM-10,
A7400DM-11, A7400DM-22,
A7400DM-20, A7400DM-21,
A7400DM-18, A7400DM-19

Jogo de chaves 3/8"



7422MBR

60 x 220 x 280 mm € 248,73 1 7422MBR

A7400DM-6, A7400DM-7, A7400DM-8, A7400DM-9, A7400DM-10, A7400DM-11, A7400DM-12, A7400DM-13, A7400DM-14, A7400DM-15, A7400DM-16, A7400DM-17, A7400DM-18, A7400DM-19, A7400DM-20, A7400DM-21, A7400DM-22

- 7750RN
- 7760, 7762
- 7754
- 7766

Conjunto de chaves de caixa 3/8"



7422MHR

50 x 160 x 350 mm € 241,85 1 7422MHR

7400SM-6, 7400SM-7, 7400SM-8, 7400SM-9, 7400SM-10, 7400SM-11, 7400SM-12, 7400SM-13, 7400SM-14, 7400SM-15, 7400SM-16, 7400SM-17, 7400SM-18, 7400SM-19, 7400SM-20, 7400SM-21, 7400SM-22

- 7750RN
- 7760, 7762
- 7754
- 7766

Jogo de chaves de caixa 3/8. Chaves de caixas bi-sextavadas, tamanhos em polegadas.



A7535DZE

165 x 500 x 45 mm € 397,56 1 A7535DZE

Chaves de caixas bi-sextavadas, tamanhos em polegadas.

A7400DZ-1/2, A7400DZ-17/32, A7400DZ-1/4, A7400DZ-3/4, A7400DZ-13/16, A7400DZ-19/32, A7400DZ-11/16, A7400DZ-3/8, A7400DZ-7/16, A7400DZ-5/16, A7400DZ-7/8, A7400DZ-9/16, A7400DZ-5/8

- 7755-3/8
- 7754
- 7760, 7762
- 7766
- 7758
- 7752

Jogo de 12 chaves de caixa em rail



7400SR/

12 35 x 220 x 25 mm € 82,22 1 7400SR/S12

7400SM-11, 7400SM-10, 7400SM-15, 7400SM-14, 7400SM-13, 7400SM-12, 7400SM-16, 7400SM-9, 7400SM-8, 7400SM-17, 7400SM-19, 7400SM-18

Conjunto de chaves de caixa 3/8" em rail



7409MB

9 € 69,49 1 7409MB

A7400DM-7, A7400DM-8, A7400DM-10, A7400DM-11, A7400DM-13, A7400DM-15, A7400DM-17, A7400DM-19, A7400DM-22

Conjunto de chaves de caixa 3/8" em rail



7408MD

8 € 118,13 1 7408MD

A7402DM-10, A7402DM-11, A7402DM-12, A7402DM-13, A7402DM-14, A7402DM-16, A7402DM-17, A7402DM-19

Jogo de 7 chaves de caixa em rail



7400TORX-ER/

7 25 x 55 x 190 mm € 80,21 1 7400TORX-ER/S7

7400TORX-E14, 7400TORX-E12, 7400TORX-E11, 7400TORX-E10, 7400TORX-E18, 7400TORX-E16, 7400TORX-E8



Jogo de chaves profundo 1/2", 12 pcs



S1612L

49 x 152 x 280 mm € 71,63 4 S1612L

Conjunto de chaves de caixa 1/2" com pontas sextavadas - 18 peças



S18HEX

100 x 210 x 370 mm € 98,67 4 S18HEX

Conjunto de chaves de caixa 1/2" com pontas sextavadas - 9 peças



S9HEX

46 x 130 x 195 mm € 49,44 10 S9HEX

Conjunto de chaves de caixa 1/2" com pontas TORX® - 18 peças



S18TORX

100 x 210 x 370 mm € 101,00 4 S18TORX

Conjunto de chaves de caixa 1/2" com pontas TORX® - 9 peças



S9TORX

46 x 130 x 195 mm € 49,44 10 S9TORX

Jogo de chave de caixa 1/2", 24 peças. 24 peças



S240

100 x 215 x 375 mm € 123,95 4 S240

24 peças

- SBS81
- 8166
- 8160-5, 8160-10
- 7772H
- 8158-10

7800SM-10, 7800SM-11, 7800SM-12, 7800SM-13, 7800SM-14, 7800SM-15, 7800SM-16, 7800SM-17, 7800SM-18, 7800SM-19, 7800SM-20, 7800SM-21, 7800SM-22, 7800SM-23, 7800SM-24, 7800SM-27, 7800SM-30, 7800SM-32



S240-BOX

Jogo de chave de caixa e chaves mistas, 40 peças. 40 peças



S400

110 x 320 x 375 mm € 183,64 2 S400

40 peças

7800SM-10, 7800SM-11, 7800SM-12, 7800SM-13, 7800SM-14, 7800SM-15, 7800SM-16, 7800SM-17, 7800SM-18, 7800SM-19, 7800SM-20, 7800SM-21, 7800SM-22, 7800SM-23, 7800SM-24, 7800SM-25, 7800SM-26, 7800SM-27, 7800SM-28, 7800SM-30, 7800SM-32



SBS81

8160-5, 8160-10

8166

7772H

8158-10

111M-7, 111M-8, 111M-9, 111M-10, 111M-11, 111M-12, 111M-13, 111M-14, 111M-15, 111M-16, 111M-17, 111M-18, 111M-19



Jogo de chave de caixa 1/2", 23 peças. 23 peças, tamanhos em polegadas



S240AF

100 x 215 x 375 mm € 123,95 4 S240AF

23 peças, tamanhos em polegadas

Conjunto de chaves de caixa 1/2" polegadas e chaves combinadas - 35 peças



S350AF

110 x 371 x 313 mm 192,56 2 S350AF

35 peças, tamanhos em polegadas.

S 3/8, S 9/16, S 1.1/4, S 1.1/16, S 1.3/16, S 15/16, S 1.1/8, S 1/2, S 1", S 5/8, S 7/8, S 3/4, S 7/16

- 815
- 703/A MP
- 763, 753
- 773

Jogo de 10 chaves de caixa. p/ parafusos sextavados interiores



7809M/10

45 x 110 x 255 mm 147,00 1 7809M/10

p/ parafusos sextavados interiores

7809M-5, 7809M-6, 7809M-7, 7809M-8, 7809M-9, 7809M-10, 7809M-12, 7809M-14, 7809M-17, 7809M-19

Conjunto de chaves de caixa de 1/2", 10 pcs.. p/ parafusos sextavados interiores



7809Z/10

45 x 110 x 255 mm 142,09 1 7809Z/10

p/ parafusos sextavados interiores

7809Z-3/8, 7809Z-5/16, 7809Z-7/16, 7809Z-1/4, 7809Z-19/32, 7809Z-5/8, 7809Z-17/32, 7809Z-9/16, 7809Z-1/2, 7809Z-3/16

Jogo de 10 chaves de caixa. p/parafusos TORX® e PHILLIPS®



7809TORX/10

45 x 110 x 255 mm 160,82 1 7809TORX/10

p/parafusos TORX® e PHILLIPS®

7809TORX-T20, 7809TORX-T27, 7809TORX-T25, 7809TORX-T40, 7809TORX-T30, 7809TORX-T45, 7809TORX-T50, 7809TORX-T55

7809M-6, 7809M-8

Conjunto de chaves de caixa de 1/2", 14 peças



7814DS

60 x 185 x 445 mm 225,13 1 7814DS

7800DM-10, 7800DM-11, 7800DM-12, 7800DM-13, 7800DM-14, 7800DM-15, 7800DM-16, 7800DM-17, 7800DM-18, 7800DM-19

8150SL

8160-5, 8160-10

8166

Conjunto de chaves de caixa de 1/2", 18 peças



7818DS

60 x 185 x 445 mm 273,56 1 7818DS

7800DM-8, 7800DM-10, 7800DM-11, 7800DM-12, 7800DM-13, 7800DM-14, 7800DM-15, 7800DM-16, 7800DM-17, 7800DM-18, 7800DM-19, 7800DM-21, 7800DM-22

8150SL

8160-5, 8160-10

8154-11

8166

Jogo chaves de caixa 1/2"



7818MHR

50 x 185 x 445 mm 274,78 1 7818MHR

7800SM-10, 7800SM-11, 7800SM-12, 7800SM-13, 7800SM-14, 7800SM-15, 7800SM-17, 7800SM-19, 7800SM-22, 7800SM-24, 7800SM-27, 7800SM-30, 7800SM-32

8150RN-1/2

8160-5, 8160-10

8154-11

8166



Jogo chaves de caixa 1/2"



7825MHP

	€		
60 x 185 x 445 mm	328,80	1	7825MHP

7800SM-10, 7800SM-11, 7800SM-12, 7800SM-13, 7800SM-14, 7800SM-15, 7800SM-16, 7800SM-17, 7800SM-18, 7800SM-19, 7800SM-20, 7800SM-21, 7800SM-22, 7800SM-23, 7800SM-24, 7800SM-26, 7800SM-27, 7800SM-28, 7800SM-30, 7800SM-32		
8150-1/2		
8160-5, 8160-10		
8154-11		
8166		

Jogo chaves de caixa 1/2"



7825MBP

	€		
60 x 185 x 445 mm	328,87	1	7825MBP

7800DM-10, 7800DM-11, 7800DM-12, 7800DM-13, 7800DM-14, 7800DM-15, 7800DM-16, 7800DM-17, 7800DM-18, 7800DM-19, 7800DM-20, 7800DM-21, 7800DM-22, 7800DM-23, 7800DM-24, 7800DM-26, 7800DM-27, 7800DM-28, 7800DM-30, 7800DM-32		
8150-1/2		
8160-5, 8160-10		
8154-11		
8166		

Jogo de chaves de caixa, 25 peças



7819DRN

	€		
51 x 225 x 445 mm	359,36	1	7819DRN

7800DM-19, 7800DM-18, 7800DM-17, 7800DM-16, 7800DM-23, 7800DM-22, 7800DM-21, 7800DM-11, 7800DM-10, 7800DM-15, 7800DM-13, 7800DM-14, 7800DM-12, 7800DM-24, 7800DM-26, 7800DM-27, 7800DM-28, 7800DM-30, 7800DM-32		
8150RN-1/2		
8152-1/2		
8166-1/2		
8160-5, 8160-10		
8154-11		
8166		

Jogo de chaves de caixa, 25 peças



7888DM

	€		
73 x 340 x 445 mm	368,78	1	7888DM

7800DM-10, 7800DM-11, 7800DM-12, 7800DM-13, 7800DM-14, 7800DM-15, 7800DM-16, 7800DM-17, 7800DM-18, 7800DM-19, 7800DM-20, 7800DM-21, 7800DM-22, 7800DM-23, 7800DM-24, 7800DM-26, 7800DM-27, 7800DM-28, 7800DM-30, 7800DM-32		
8150-1/2		
8154-11		
8160-3, 8160-5, 8160-10		
8166		
8157-15		

Conjunto de chaves de caixa de 1/4"e 1/2", 47 peças



7847SS

	€		
60 x 225 x 445 mm	565,69	1	7847SS

6700SM-5, 6700SM-6, 6700SM-7, 6700SM-8, 6700SM-9, 6700SM-10, 6700SM-11, 6700SM-12, 6700SM-13		
6950SL		
6960, 6962		
6954		
6966		
6956		
59S/PH1, 59S/PH2, 59S/PH3		
59S/PZ1, 59S/PZ2, 59S/PZ3		
59S/0.6-4.5, 59S/0.8-5.5, 59S/1.2-8.0		
59S/H3, 59S/H4, 59S/H5, 59S/H6		
7800SM-10, 7800SM-11, 7800SM-12, 7800SM-13, 7800SM-14, 7800SM-15, 7800SM-17, 7800SM-19, 7800SM-22, 7800SM-24, 7800SM-27, 7800SM-30, 7800SM-32		
8150SL		
6973A		
8160-5, 8160-10		
8154-11		
8166		

Conjunto de chaves de caixa de 1/2", AF, 17 peças. Caixa metálica



7817DZS

	€		
60 x 185 x 445 mm	264,01	1	7817DZS

7800DZ-3/8, 7800DZ-7/16, 7800DZ-1/2,
7800DZ-9/16, 7800DZ-5/8, 7800DZ-
11/16, 7800DZ-3/4, 7800DZ-13/16,
7800DZ-7/8, 7800DZ-15/16, 7800DZ-1,
7800DZ-1.1/8, 7800DZ-1.1/4

8150SL

8160-5, 8160-10

8166

Conjunto de chaves de caixa quadradas
de 1/2" com perfil sextavado duplo no
sistema imperial e roquete de cabeça fina
- 16 peças



7817DZS1

60 x 185 x 445 mm 4500 g 212,56 1 7817DZS1

7800DZ-3/8, 7800DZ-7/16, 7800DZ-1/2,
7800DZ-9/16, 7800DZ-5/8, 7800DZ-
11/16, 7800DZ-3/4, 7800DZ-13/16,
7800DZ-7/8, 7800DZ-15/16, 7800DZ-1,
7800DZ-1.1/8, 7800DZ-1.1/16

8150SL

8160-5, 8160-10

8166

Conjunto de chaves de caixa de 1/2", AF,
23 peças



7823DZS

60 x 185 x 445 mm 310,93 1 7823DZS

7800DZ-3/8, 7800DZ-7/16, 7800DZ-1/2,
7800DZ-9/16, 7800DZ-19/32, 7800DZ-
5/8, 7800DZ-11/16, 7800DZ-3/4,
7800DZ-25/32, 7800DZ-13/16, 7800DZ-
7/8, 7800DZ-15/16, 7800DZ-1, 7800DZ-
1.1/16, 7800DZ-1.1/8, 7800DZ-1.3/16,
7800DZ-1.1/4, 7800DZ-1.5/16

8150SL

8160-5, 8160-10

8154-11

8166

Conjunto de chaves de caixa de 1/2", 18
peças



7818DST

60 x 220 x 480 mm 243,83 1 7818DST

7800DM-8, 7800DM-10, 7800DM-11,
7800DM-12, 7800DM-13, 7800DM-14,
7800DM-15, 7800DM-16, 7800DM-17,
7800DM-18, 7800DM-19, 7800DM-21,
7800DM-22

8150SL

8160-5, 8160-10

8166

8154-11

Conjunto de chaves de caixa de 1/2", 18
peças



7818SST

60 x 220 x 480 mm 254,94 1 7818SST

7800SM-10, 7800SM-11, 7800SM-12,
7800SM-13, 7800SM-14, 7800SM-15,
7800SM-17, 7800SM-19, 7800SM-22,
7800SM-24, 7800SM-27, 7800SM-30,
7800SM-32

8150SL

8160-1/2, 8162-1/2, 8166-1/2, 8154-1/2

Conjunto de chaves de caixa de 1/2", 25
peças



7825SST

65 x 250 x 480 mm 307,42 1 7825SST

7800SM-10, 7800SM-11, 7800SM-12, 7800SM-
13, 7800SM-14, 7800SM-15, 7800SM-16,
7800SM-17, 7800SM-18, 7800SM-19, 7800SM-
20, 7800SM-21, 7800SM-22, 7800SM-23,
7800SM-24, 7800SM-26, 7800SM-27, 7800SM-
28, 7800SM-30, 7800SM-32

8150SL

8160-1/2, 8162-1/2, 8166-1/2, 8154-1/2

Conjunto de chaves de caixa de 1/2", 25
peças



7825DST

65 x 250 x 480 mm 307,42 1 7825DST

7800DM-10, 7800DM-11, 7800DM-12,
7800DM-13, 7800DM-14, 7800DM-15,
7800DM-16, 7800DM-17, 7800DM-18,
7800DM-19, 7800DM-20, 7800DM-21,
7800DM-22, 7800DM-23, 7800DM-24,
7800DM-26, 7800DM-27, 7800DM-28

8150SL

8160-1/2, 8162-1/2, 8166-1/2, 8154-1/2



Conjunto de chaves de caixa de 1/2", 27 peças



7827DST

65 x 250 x 480 mm € 370,65 1 7827DST

7800DM-10, 7800DM-11, 7800DM-12, 7800DM-13, 7800DM-14, 7800DM-15, 7800DM-16, 7800DM-17, 7800DM-18, 7800DM-19, 7800DM-20, 7800DM-21, 7800DM-22, 7800DM-23, 7800DM-24, 7800DM-26, 7800DM-27, 7800DM-28, 7800DM-30, 7800DM-32

8150SL

8159-1/2, 8160-1/2, 8162-1/2, 8154-1/2, 8166-1/2, 8158-1/2

Jogo de chaves de caixa 1/2' em calha



7810MH

10 € 75,77 1 7810MH

7800SM-10, 7800SM-11, 7800SM-13, 7800SM-14, 7800SM-15, 7800SM-16, 7800SM-19, 7800SM-17, 7800SM-21, 7800SM-22

Jogo de chaves de caixa 1/2' em calha



7810MB

10 € 75,77 1 7810MB

7800DM-11, 7800DM-10, 7800DM-14, 7800DM-13, 7800DM-16, 7800DM-17, 7800DM-19, 7800DM-22, 7800DM-21, 7800DM-15

Jogo de chaves de caixa 1/2' em calha



7806MD

6 € 103,61 1 7806MD

7805DM-10, 7805DM-14, 7805DM-13, 7805DM-17, 7805DM-19, 7805DM-22

Jogo de chaves de caixa 1/2' em calha



7807TE

7 € 72,98 1 7807TE

7800TORX-E10, 7800TORX-E12, 7800TORX-E14, 7800TORX-E16, 7800TORX-E18, 7800TORX-E20, 7800TORX-E24

Juego de chaves de caixa 3/4". Tamanhos métricos



SLX 17

375 x 430 x 110 mm € 269,86 1 SLX 17

Tamanhos métricos

Jogo Chaves Caixa Polegadas 3/4" 17 peças. Tamanhos em polegadas



SLX17AF

70 x 375 x 430 mm € 269,86 1 SLX 17AF

Tamanhos em polegadas

Jogo de chaves de caixa, 15 peças.
Chaves de caixa sextavadas, tamanhos métricos.



8845NM

	€		
94 x 206 x 591 mm	583,74	1	8845NM

Chaves de caixa sextavadas, tamanhos métricos.

8900SM-24, 8900SM-22, 8900SM-27, 8900SM-30, 8900SM-32, 8900SM-36, 8900SM-38, 8900SM-41, 8900SM-46, 8900SM-50	
8953	
8954A	
8962, 8961	
8950N/A	

Jogo de chaves de caixa, 15 peças.
Chaves de caixas bi-sextavadas, tamanhos métricos.



8845DM

	€		
94 x 206 x 591 mm	574,59	1	8845DM

Chaves de caixas bi-sextavadas, tamanhos métricos.

8900DM-19, 8900DM-22, 8900DM-24, 8900DM-27, 8900DM-30, 8900DM-32, 8900DM-36, 8900DM-41, 8900DM-46, 8900DM-50	
8950N/A	
8953	
8954A	
8961, 8962	

Conjunto chaves de caixa 3/4'



8821MB

	€		
95 x 220 x 600 mm	828,15	1	8821MB

8950N/A	
8954	
8965	
8966	
8961, 8962	
8900DM-26, 8900DM-23, 8900DM-22, 8900DM-24, 8900DM-27, 8900DM-29, 8900DM-28, 8900DM-32, 8900DM-30, 8900DM-34, 8900DM-38, 8900DM-35, 8900DM-36, 8900DM-46, 8900DM-41, 8900DM-42, 8900DM-50	

Jogo de chaves de caixa, 24 peças.
Chaves de caixas bi-sextavadas, tamanhos métricos.



8840M

	€		
100 x 210 x 595 mm	1.204,85	1	8840M

Chaves de caixas bi-sextavadas, tamanhos métricos.

8900DM-19, 8900DM-22, 8900DM-24, 8900DM-25, 8900DM-27, 8900DM-28, 8900DM-30, 8900DM-32, 8900DM-36, 8900DM-41, 8900DM-46, 8900DM-50, 8900DM-55, 8900DM-60	
8953	
8950N/A	
8951	
8954A	
8958A	
8962, 8961	
8966	
8965	
8172	

Jogo de chave de caixa 1". Caixa metálica



9540MB

	€		
210 x 560 x 120 mm	1.154,73	1	9540MB

Caixa metálica

9500SM-80, 9500SM-75, 9500SM-70, 9500SM-65, 9500SM-60, 9500SM-55, 9500SM-50, 9500SM-46	
9550AB	
9555	
9560AB, 9563AB	

Jogos de chaves de caixa em caixa esmaltada de metal. Caixa metálica



9540MBL

	€		
225 x 605 x 120 mm	1.707,50	1	9540MBL

Caixa metálica

9500SM-80, 9500SM-77, 9500SM-71, 9500SM-70, 9500SM-67, 9500SM-65, 9500SM-63, 9500SM-60, 9500SM-75, 9500SM-46, 9500SM-50, 9500SM-54, 9500SM-55, 9500SM-58	
9550AB	
9560AB, 9563AB	
9555	



Conjunto de chaves de caixa 1" com perfil sextavado duplo em polegadas - 12 peças



9540DZ

€	Icon	Icon
150 x 260 x 670 mm	1.358,07	1 9540DZ

9550AB

9555

9563AB, 9560AB

9500DZ-2.3/4, 9500DZ-2.3/8, 9500DZ-2.3/16, 9500DZ-3, 9500DZ-1.13/16, 9500DZ-3.1/8, 9500DZ-2.5/8, 9500DZ-2

Conjunto de chaves de caixa 1" com perfil sextavado duplo em polegadas - 19 peças



9540DZL

€	Icon	Icon
140 x 285 x 630 mm	1.858,94	1 9540DZL

9500DZ-2.1/4, 9500DZ-2.3/4, 9500DZ-2.3/8, 9500DZ-2.1/2, 9500DZ-2.15/16, 9500DZ-2.1/8, 9500DZ-1.7/8, 9500DZ-2.3/16, 9500DZ-3, 9500DZ-1.13/16, 9500DZ-3.1/8, 9500DZ-2.5/8, 9500DZ-2, 9500DZ-2.9/16

9550AB

9555

9563AB, 9560AB

9565AB

1/4"

Chave de caixa, 6 faces. Perfil hexagonal, tamanhos métricos.



6700SM

€	Icon	Icon
4 mm	5,13	5 6700SM-4
4.5 mm	5,13	5 6700SM-4.5
5 mm	5,13	5 6700SM-5
5.5 mm	5,13	5 6700SM-5.5
6 mm	5,13	5 6700SM-6
7 mm	5,13	5 6700SM-7
8 mm	5,13	5 6700SM-8
9 mm	5,13	5 6700SM-9
10 mm	5,13	5 6700SM-10
11 mm	5,13	5 6700SM-11
12 mm	5,13	5 6700SM-12
13 mm	5,13	5 6700SM-13
14 mm	5,13	5 6700SM-14
4 mm	5,84	1 SB6700SM-4
4.5 mm	5,84	1 SB6700SM-4.5
5 mm	5,84	1 SB6700SM-5
5.5 mm	5,84	1 SB6700SM-5.5
6 mm	5,84	1 SB6700SM-6
7 mm	5,84	1 SB6700SM-7
8 mm	5,84	1 SB6700SM-8
9 mm	5,84	1 SB6700SM-9
10 mm	5,84	1 SB6700SM-10
11 mm	5,84	1 SB6700SM-11
12 mm	5,84	1 SB6700SM-12
13 mm	5,84	1 SB6700SM-13
14 mm	5,84	1 SB6700SM-14

SB = Em embalagem individual num cartão informativo de plástico

Chave de caixa, 6 faces. Perfil hexagonal, tamanhos em polegadas.



6700SZ

€	Icon	Icon
1/8 in	5,21	5 6700SZ-1/8
5/32 in	5,21	5 6700SZ-5/32
3/16 in	5,21	5 6700SZ-3/16
7/32 in	5,21	5 6700SZ-7/32
1/4 in	5,21	5 6700SZ-1/4
9/32 in	5,21	5 6700SZ-9/32
5/16 in	5,21	5 6700SZ-5/16
11/32 in	5,21	5 6700SZ-11/32
3/8 in	5,21	5 6700SZ-3/8
7/16 in	5,21	5 6700SZ-7/16
1/2 in	5,21	5 6700SZ-1/2

€	Icon	Icon
9/16 in	5,21	5 6700SZ-9/16
1/8 in	5,89	5 SB6700SZ-1/8
5/32 in	5,89	1 SB6700SZ-5/32
3/16 in	5,89	1 SB6700SZ-3/16
7/32 in	5,89	1 SB6700SZ-7/32
1/4 in	5,89	1 SB6700SZ-1/4
9/32 in	5,89	1 SB6700SZ-9/32
5/16 in	5,89	1 SB6700SZ-5/16
11/32 in	5,89	1 SB6700SZ-11/32
3/8 in	5,89	1 SB6700SZ-3/8
7/16 in	5,89	1 SB6700SZ-7/16
1/2 in	5,89	1 SB6700SZ-1/2
9/16 in	5,89	1 SB6700SZ-9/16

SB = Em embalagem individual num cartão informativo de plástico

Chave de caixa, 6 faces. Para parafusos Torx.



6700TORX-E

€	Icon	Icon
E4	6,87	5 6700TORX-E4
E5	6,87	5 6700TORX-E5
E6	6,87	5 6700TORX-E6
E7	6,87	5 6700TORX-E7
E8	6,87	5 6700TORX-E8
E10	6,87	5 6700TORX-E10
E4	7,55	1 SB6700TORX-E4
E5	7,55	1 SB6700TORX-E5
E6	7,55	1 SB6700TORX-E6
E7	7,55	1 SB6700TORX-E7
E8	7,55	1 SB6700TORX-E8
E10	7,55	1 SB6700TORX-E10

SB = Em embalagem individual num cartão informativo de plástico

Chaves de caixa quadradas com perfil quadrado no sistema métrico para chave de roquete para refrigeração 1/4"



R6810M

€	Icon	Icon
3.4 mm	11,56	5 R6810M-3,4
4 mm	11,56	5 R6810M-4
4.5 mm	11,56	5 R6810M-4,5
5 mm	11,81	5 R6810M-5
6 mm	11,81	5 R6810M-6
7 mm	12,07	1 R6810M-7
8 mm	12,75	5 R6810M-8
9 mm	12,75	5 R6810M-9
10 mm	13,57	5 R6810M-10

Chaves de caixa quadradas com perfil quadrado no sistema imperial para chave de roquete para refrigeração 1/4"



R6810Z

€	📦	🐟	
3/16 in	11,82	1	R6810Z-3/16
7/32 in	11,82	1	R6810Z-7/32
1/4 in	11,82	1	R6810Z-1/4
5/16 in	14,38	1	R6810Z-5/16
3/8 in	14,38	1	R6810Z-3/8

Adaptador de chave quadrada de canalização para chave de roquete para refrigeração 1/4"



R6822Z

€	📦	🐟	
14,39	5		R6822Z

Adaptador fêmea para fêmea de chave quadrada 1/4"



R6967

€	📦	🐟	
13,51	5		R6967

Adaptador macho para macho de chave quadrada 1/4"



R6964A

€	📦	🐟	
6,40	1		R6964A

Chave de caixa, 12 faces. Perfil bi-hexagonal, tamanhos em polegadas. De parede fina.



A6700DM

€	📦	🐟	
5 mm	5,13	5	A6700DM-5
5.5 mm	5,13	5	A6700DM-5.5
6 mm	5,13	5	A6700DM-6
7 mm	5,13	5	A6700DM-7
8 mm	5,13	5	A6700DM-8
9 mm	5,13	5	A6700DM-9
10 mm	5,13	5	A6700DM-10
11 mm	5,13	5	A6700DM-11
12 mm	5,13	5	A6700DM-12
13 mm	5,13	5	A6700DM-13
14 mm	5,13	5	A6700DM-14
5 mm	5,80	1	SBA6700DM-5
5.5 mm	5,80	1	SBA6700DM-5.5
6 mm	5,80	1	SBA6700DM-6
7 mm	5,80	1	SBA6700DM-7
8 mm	5,80	1	SBA6700DM-8
9 mm	5,80	1	SBA6700DM-9
10 mm	5,80	1	SBA6700DM-10
11 mm	5,80	1	SBA6700DM-11
12 mm	5,80	1	SBA6700DM-12
13 mm	5,80	1	SBA6700DM-13
14 mm	5,80	1	SBA6700DM-14

SB = Em embalagem individual num cartão informativo de plástico

Chave de caixa, 12 faces. Perfil bi-hexagonal, tamanhos em polegadas. De parede fina.



A6700DZ

€	📦	🐟	
3/16 in	6,50	5	A6700DZ-3/16
7/32 in	6,50	5	A6700DZ-7/32
1/4 in	6,50	5	A6700DZ-1/4

€	📦	🐟	
9/32 in	6,50	5	A6700DZ-9/32
5/16 in	6,50	5	A6700DZ-5/16
11/32 in	6,50	5	A6700DZ-11/32
3/8 in	6,58	5	A6700DZ-3/8
7/16 in	6,58	5	A6700DZ-7/16
1/2 in	6,58	5	A6700DZ-1/2
9/16 in	6,58	5	A6700DZ-9/16
3/16 in	7,16	1	SBA6700DZ-3/16
7/32 in	7,16	1	SBA6700DZ-7/32
1/4 in	7,16	1	SBA6700DZ-1/4
9/32 in	7,16	1	SBA6700DZ-9/32
5/16 in	7,16	1	SBA6700DZ-5/16
11/32 in	7,16	1	SBA6700DZ-11/32
3/8 in	7,25	1	SBA6700DZ-3/8
7/16 in	7,25	1	SBA6700DZ-7/16
1/2 in	7,25	1	SBA6700DZ-1/2
9/16 in	7,25	1	SBA6700DZ-9/16

SB = Em embalagem individual num cartão informativo de plástico

Chave de caixa série longa, 12 faces. Perfil bi-hexagonal, tamanhos métricos. De parede fina.



A6800DM

€	📦	🐟	
4 mm	12,05	1	A6800DM-4
5 mm	12,05	1	A6800DM-5
5.5 mm	12,05	1	A6800DM-5.5
6 mm	12,05	1	A6800DM-6
7 mm	12,05	1	A6800DM-7
8 mm	12,05	1	A6800DM-8
9 mm	12,05	1	A6800DM-9
10 mm	12,05	1	A6800DM-10
11 mm	12,05	1	A6800DM-11
12 mm	12,05	1	A6800DM-12
13 mm	12,05	1	A6800DM-13
14 mm	12,05	1	A6800DM-14
4 mm	12,73	1	SBA6800DM-4
5 mm	12,73	1	SBA6800DM-5
5.5 mm	12,73	1	SBA6800DM-5.5
6 mm	12,73	1	SBA6800DM-6
7 mm	12,73	1	SBA6800DM-7
8 mm	12,73	1	SBA6800DM-8
9 mm	12,73	1	SBA6800DM-9
10 mm	12,73	1	SBA6800DM-10
11 mm	12,73	1	SBA6800DM-11
12 mm	12,73	1	SBA6800DM-12
13 mm	12,73	1	SBA6800DM-13
14 mm	12,73	1	SBA6800DM-14

SB = Em embalagem individual num cartão informativo de plástico



Chaves de caixa série longa de 1/4", sextavadas. Tamanhos métricos. De parede fina.



A6800SM

€	SB	Q	Modelo
11,87	1	1	A6800SM-4
11,87	1	1	A6800SM-4.5
11,87	1	1	A6800SM-5
11,87	1	1	A6800SM-6
11,87	1	1	A6800SM-7
11,87	1	1	A6800SM-8
11,87	1	1	A6800SM-9
11,87	1	1	A6800SM-10
11,87	1	1	A6800SM-11
11,87	1	1	A6800SM-12
11,87	1	1	A6800SM-13
11,87	1	1	A6800SM-14
11,87	1	1	A6800SM-15

SB = Em embalagem individual num cartão informativo de plástico

Chaves de caixa série longa de 1/4", 6 pontos, polegadas. Perfil sextavado, em polegadas. De parede fina



A6800SZ

€	SB	Q	Modelo
15,26	1	1	A6800SZ-1/8
15,26	1	1	A6800SZ-5/32

Chave de caixa série longa, 12 faces. Perfil bi-hexagonal, tamanhos em polegadas. De parede fina.



A6800DZ

€	SB	Q	Modelo
14,56	1	1	A6800DZ-3/16
14,56	1	1	A6800DZ-7/32
14,56	1	1	A6800DZ-1/4
14,56	1	1	A6800DZ-9/32
14,56	1	1	A6800DZ-5/16
14,56	1	1	A6800DZ-11/32
14,56	1	1	A6800DZ-3/8
14,56	1	1	A6800DZ-7/16

€	SB	Q	Modelo
14,56	1	1	A6800DZ-1/2
14,56	1	1	A6800DZ-9/16
15,23	1	1	SBA6800DZ-3/16
15,23	1	1	SBA6800DZ-7/32
15,23	1	1	SBA6800DZ-1/4
15,23	1	1	SBA6800DZ-9/32
15,23	1	1	SBA6800DZ-5/16
15,23	1	1	SBA6800DZ-11/32
15,23	1	1	SBA6800DZ-3/8
15,23	1	1	SBA6800DZ-7/16
15,23	1	1	SBA6800DZ-1/2
15,23	1	1	SBA6800DZ-9/16

SB = Em embalagem individual num cartão informativo de plástico

Chave de caixa articulada, 12 faces. Perfil bi-hexagonal, tamanhos métricos. De parede fina.



A6710DM

€	SB	Q	Modelo
41,58	1	1	A6710DM-5.5
41,58	1	1	A6710DM-6
41,58	1	1	A6710DM-7
41,58	1	1	A6710DM-8
41,58	1	1	A6710DM-9
41,58	1	1	A6710DM-10
42,25	1	1	A6710DM-11
42,25	1	1	A6710DM-12
42,25	1	1	A6710DM-13
42,25	1	1	A6710DM-14

Perfil bi-hexagonal, tamanhos métricos. De parede fina.

Chave de caixa articulada, 12 faces. Perfil bi-hexagonal, tamanhos em polegadas. De parede fina.



A6710DZ

€	SB	Q	Modelo
42,25	1	1	A6710DZ-3/16
42,25	1	1	A6710DZ-7/32
42,25	1	1	A6710DZ-1/4
42,25	1	1	A6710DZ-9/32
42,25	1	1	A6710DZ-5/16
42,25	1	1	A6710DZ-11/32
42,25	1	1	A6710DZ-3/8
42,49	1	1	A6710DZ-7/16
42,49	1	1	A6710DZ-1/2
42,49	1	1	A6710DZ-9/16

Perfil bi-hexagonal, tamanhos em polegadas. De parede fina.

Cabo articulado



6958

€	SB	Q	Modelo
21,58	1	1	6958-6
43,05	1	1	SB6958-6

SB = Em embalagem individual num cartão informativo de plástico

Cabo em T correção



6954

€	SB	Q	Modelo
11,63	1	1	6954
12,31	10	10	SB6954-5

SB = Em embalagem individual num cartão informativo de plástico

Extensão 1/4" com cabo. Com 1/4" quadrado fêmea no cabo



6956

€	SB	Q	Modelo
12,02	10	10	6956
12,70	1	1	SB6956

SB = Em embalagem individual num cartão informativo de plástico

Extensor 1/4". SB=embalagem individual



6960 - 6962L

L	€		
26 mm	7,71	1	696EX-01
50 mm	8,98	1	6960
75 mm	9,27	10	6960-3
101 mm	10,43	1	6961
152 mm	12,46	1	6962
152 mm	9,30	1	696EX-06
200 mm	12,82	1	696EX-08
276 mm	14,14	1	696EX-11
355 mm	29,85	1	6962L
53 mm	10,31	1	SB6960
75 mm	12,23	1	SB6960-3
101 mm	11,83	1	SB6961
152 mm	13,93	1	SB6962
355 mm	30,54	1	SB6962L

SB=embalagem individual

Extensores



6960-W - 6962-W

L	€		
50 mm	11,02	10	6960W-2
100 mm	12,86	1	6960W-4
150 mm	14,70	10	6960W-6

Extensor flexível



6963

L	€		
148 mm	20,58	1	SB6963
150 mm	9,86	20	6960F-6

Cardan universal



6966

L	€		
35 mm	23,63	10	6966
35 mm	24,31	1	SB6966

SB = Em embalagem individual num cartão informativo de plástico

Cardan universal 1/4', operação suave



6968

L	€		
35 mm	30,09	1	6968

Extensor de 1/4" a 3/8"



7765

		€		
1/4	3/8	10,24	1	7765
1/4	3/8	10,38	1	SB7765

Adaptador de 1/4" para bits de 1/4"



6709HL

	€		
1/4 in	9,70	1	6709HL

Adaptador para bits. Com encabadouro macho de 1/4"



6972H

		€		
1/4" in	1/4"	22,59	5	6972H

Com encabadouro macho de 1/4"

Adaptador de 1/4" para bits de 1/4"



6973M

		€		
1/4"	1/4" in	6,69	1	6973M



Adaptador 1/4' para bits 1/4'



6973A

	€		
1/4 in	7,29	10	6973A
1/4 in	5,85	1	SB6973A

SB = Em embalagem individual num cartão informativo de plástico

Adaptadores de encaixe quadrado de 1/4" para adaptadores planos de chave de caixas de 1/4



6969

	€		
1/4	1,34	1	6969

Extensor magnetizado de 1/4" a 3/8". Com íman no disco



7767

	€		
1/4	24,17	1	7767
1/4	24,85	1	SB7767

SB = Em embalagem individual num cartão informativo de plástico

Jogo de 3 extensores magnetizados



8967/S3

	€		
110 x 194 x 30 mm	85,14	1	8967/S3

7767

8167

8967

Railes e clips 3/8"



RAIL-187/264/340

L	€		
203 mm	2,58	10	RAIL-8
250 mm	2,84	10	RAIL-10
340 mm	3,21	3	RAIL-340

Railes e clips 1/4"



C1/4

L	€		
17 mm	0,37	25	CLIPS-1/4

Chaves de caixa p/ parafusos de fenda



6709F

		€		
0.6 mm	4.5 mm	6,81	5	6709F-4.5
0.8 mm	5.5 mm	6,81	5	6709F-5.5
0.9 mm	6.5 mm	6,81	5	6709F-6.5
1.2 mm	8 mm	6,81	5	6709F-8
0.6 mm	4.5 mm	7,51	1	SB6709F-4.5
0.8 mm	5.5 mm	7,51	1	SB6709F-5.5
0.9 mm	6.5 mm	7,52	1	SB6709F-6.5
1.2 mm	8 mm	7,51	1	SB6709F-8

SB = Em embalagem individual num cartão informativo de plástico

Chaves de caixa p/parafusos PHILLIPS®



6709PH

	€		
1	7,45	5	6709PH-1
2	7,45	5	6709PH-2
3	7,45	5	6709PH-3
1	8,14	1	SB6709PH-1
2	8,14	1	SB6709PH-2
3	8,14	1	SB6709PH-3

SB = Em embalagem individual num cartão informativo de plástico

Chaves de caixa p/parafusos POZIDRIV®



6709PZ

	€		
1	7,91	5	6709PZ-1
2	7,91	5	6709PZ-2
3	7,91	5	6709PZ-3

	€		
1	8,58	1	SB6709PZ-1
2	8,58	1	SB6709PZ-2
3	8,58	1	SB6709PZ-3

SB = Em embalagem individual num cartão informativo de plástico

Chaves de caixa p/ parafusos TORX®



6709TORX

	€		
T6	8,09	5	6709TORX-T6
T7	8,09	5	6709TORX-T7
T8	8,39	5	6709TORX-T8
T9	8,39	5	6709TORX-T9
T10	8,39	5	6709TORX-T10
T15	8,39	5	6709TORX-T15
T20	8,39	5	6709TORX-T20
T25	8,67	5	6709TORX-T25
T27	8,67	5	6709TORX-T27
T30	8,67	5	6709TORX-T30
T40	8,67	5	6709TORX-T40
T8	9,07	1	SB6709TORX-T8
T9	9,07	1	SB6709TORX-T9
T10	9,07	1	SB6709TORX-T10
T15	9,07	1	SB6709TORX-T15
T20	9,07	1	SB6709TORX-T20
T25	9,33	1	SB6709TORX-T25
T27	9,33	1	SB6709TORX-T27
T30	9,33	1	SB6709TORX-T30
T40	9,33	1	SB6709TORX-T40

SB = Em embalagem individual num cartão informativo de plástico

Chaves de caixa p/ parafusos TORX® TAMPER RESISTANT



6709TORX-R

	€		
TR 8	8,79	1	6709TORX-R-T8
TR 10	8,79	1	6709TORX-R-T10
TR 15	8,79	1	6709TORX-R-T15
TR 20	8,79	1	6709TORX-R-T20
TR 25	9,11	1	6709TORX-R-T25
TR 8	9,46	1	SB6709TORX-R-T8
TR 10	9,46	1	SB6709TORX-R-T10

	€		
TR 15	9,46	1	SB6709TORX-R-T15
TR 20	9,46	1	SB6709TORX-R-T20
TR 25	9,79	1	SB6709TORX-R-T25

SB = Em embalagem individual num cartão informativo de plástico

Chave caixa encaixe quad. 1/4", p/ parafusos cbç TORX PLUS®



6709-IP

	€		
IP6	8,39	1	6709-IP6
IP7	8,39	1	6709-IP7
IP8	8,71	1	6709-IP8
IP9	8,71	1	6709-IP9
IP10	8,77	1	6709-IP10
IP15	8,77	1	6709-IP15
IP20	8,77	1	6709-IP20
IP25	9,10	1	6709-IP25
IP27	8,77	1	6709-IP27
IP30	8,39	1	6709-IP30
IP40	10,46	1	6709-IP40
IP45	10,46	1	6709-IP45

SB = Em embalagem individual

Chaves de caixa sextavado interior, série curta



6709M

	€		
3 mm	6,74	5	6709M-3
4 mm	6,74	5	6709M-4
5 mm	6,74	5	6709M-5
6 mm	6,74	5	6709M-6
8 mm	6,74	5	6709M-8
10 mm	6,73	5	6709M-10
3 mm	3,50	1	SBS67M-3
4 mm	7,41	1	SB6709M-4
5 mm	7,41	1	SB6709M-5
6 mm	7,41	1	SB6709M-6
8 mm	7,41	1	SB6709M-8

SB = Em embalagem individual num cartão informativo de plástico

Chaves de caixa sextavado interior, série longa. Tamanhos métricos.



A6709M

	€		
2.5 mm	31,94	1	A6709M-2.5
3 mm	31,94	1	A6709M-3
4 mm	31,94	1	A6709M-4
5 mm	31,94	1	A6709M-5
6 mm	31,94	1	A6709M-6
2.5 mm	32,79	1	SBA6709M-2.5
3 mm	32,79	1	SBA6709M-3
4 mm	32,79	1	SBA6709M-4
5 mm	32,62	1	SBA6709M-5
6 mm	32,62	1	SBA6709M-6

SB = Em embalagem individual num cartão informativo de plástico

Chaves de caixa sextavado interior, série longa. Tamanhos em polegadas



A6709Z

	€		
1/8 in	31,94	1	A6709Z-1/8
9/64 in	31,94	1	A6709Z-9/64
5/32 in	31,94	1	A6709Z-5/32
3/16 in	31,94	1	A6709Z-3/16
1/8 in	32,62	1	SBA6709Z-1/8
9/64 in	32,62	1	SBA6709Z-9/64
5/32 in	32,62	1	SBA6709Z-5/32
3/16 in	32,62	1	SBA6709Z-3/16

SB = Em embalagem individual num cartão informativo de plástico



Roquete reversível 1/4". 72 dentes/5° de ângulo de ação. Cabeça esguia para espaços estreitos. Cabeça estreita para espaços apertados.



6950SL

		€		
119 mm	72	41,21	1	6950SL

Cabeça estreita para espaços apertados.

Roquete reversível 1/4" de 72 dentes. Ângulo de ação. Selado. SB=Embalagem unitária



6950

		€		
121 mm	72	40,82	1	6950
121 mm	72	41,54	1	SB6950

Ângulo de ação. Selado. SB=Embalagem unitária

Roquete reversível 1/4" Redondo de 72 dentes. Seta indicadora. SB=embalagem unitária



6950RN

		€		
121 mm	72	36,99	1	6950RN
121 mm	72	37,63	1	SB6950RN

Seta indicadora. SB=embalagem unitária

Roquete reversível para refrigeração



R6950

		€		
160 mm	32	104,43	1	R6950



Roquete de cabeça articulada



8120-1/4

		€		
149 mm	72	38,34	20	8120-1/4

Roquete reversível 1/4". embalagem unitária



SBS61

		€		
145 mm	60	24,24	1	SBS61

SB = Em embalagem individual

Chaves de roquete combinadas para pontas de chave de parafusos



2058-BR

	€		
52	10,24	1	2058-BR

Roquete de pera 1/4", curto, com função de desengate rápido



SBS61S

		€		
120 mm	60	23,40	1	SBS61S

SB = Em embalagem individual

Adaptador para roquete reversível, 60 dentes. 60 dentes/ Ângulo de ação 6°.



6951

	€		
40 mm	80,43	1	6951

60 dentes/ Ângulo de ação 6°.

Acessórios para roquete 1/4' 6950SL



6950SL-SPARE

QTY	Part No.	Price	Unit	Part No.
10	6950SL	17,63	1	6950SL-SPARE

Acessórios para roquete 1/4' 6950



6950-SPARE

QTY	Part No.	Price	Unit	Part No.
12	6950	18,13	1	6950-SPARE

Acessórios para roquete 1/4' 6950RN



6950RN-SPARE

QTY	Part No.	Price	Unit	Part No.
6	6950RN	17,41	1	6950RN-SPARE

3/8"

Chave de caixa, 6 faces. Perfil hexagonal, tamanhos métricos.



7400SM

Size	Price	QTY	Part No.
6 mm	5,58	5	7400SM-6
7 mm	5,58	5	7400SM-7
8 mm	5,68	5	7400SM-8
9 mm	5,90	5	7400SM-9
10 mm	6,12	5	7400SM-10
11 mm	6,20	5	7400SM-11
12 mm	6,29	5	7400SM-12
13 mm	6,45	5	7400SM-13
14 mm	6,89	5	7400SM-14
15 mm	7,16	5	7400SM-15
16 mm	7,56	5	7400SM-16
17 mm	7,74	5	7400SM-17
18 mm	7,92	5	7400SM-18
19 mm	8,24	5	7400SM-19
20 mm	8,46	5	7400SM-20
21 mm	8,71	5	7400SM-21
22 mm	8,85	5	7400SM-22
6 mm	6,26	1	SB7400SM-6
7 mm	6,26	1	SB7400SM-7
8 mm	6,36	1	SB7400SM-8
9 mm	6,58	1	SB7400SM-9
10 mm	6,79	1	SB7400SM-10
11 mm	6,87	1	SB7400SM-11
12 mm	6,98	1	SB7400SM-12
13 mm	7,12	1	SB7400SM-13
14 mm	7,56	1	SB7400SM-14
15 mm	7,85	1	SB7400SM-15
16 mm	8,23	1	SB7400SM-16
17 mm	8,40	1	SB7400SM-17
18 mm	8,60	1	SB7400SM-18
19 mm	8,93	1	SB7400SM-19
20 mm	9,14	1	SB7400SM-20
21 mm	9,38	1	SB7400SM-21
22 mm	9,53	1	SB7400SM-22

SB = Em embalagem individual num cartão informativo de plástico

Chave de caixa, 12 faces. Perfil bi-hexagonal, tamanhos em polegadas. De parede fina.



A7400DM

Size	Price	QTY	Part No.
6 mm	7,44	5	A7400DM-6
7 mm	7,44	5	A7400DM-7
8 mm	7,44	5	A7400DM-8

Size	Price	QTY	Part No.
9 mm	7,44	5	A7400DM-9
10 mm	7,44	5	A7400DM-10
11 mm	7,44	5	A7400DM-11
12 mm	7,44	5	A7400DM-12
13 mm	7,44	5	A7400DM-13
14 mm	7,44	5	A7400DM-14
15 mm	7,55	5	A7400DM-15
16 mm	7,55	5	A7400DM-16
17 mm	7,55	5	A7400DM-17
18 mm	7,55	5	A7400DM-18
19 mm	7,55	5	A7400DM-19
20 mm	7,55	5	A7400DM-20
21 mm	7,64	5	A7400DM-21
22 mm	7,64	5	A7400DM-22
24 mm	8,06	5	A7400DM-24
6 mm	8,11	1	SBA7400DM-6
7 mm	8,11	1	SBA7400DM-7
8 mm	8,11	1	SBA7400DM-8
9 mm	8,11	1	SBA7400DM-9
10 mm	8,11	1	SBA7400DM-10
11 mm	8,11	1	SBA7400DM-11
12 mm	8,11	1	SBA7400DM-12
13 mm	8,11	1	SBA7400DM-13
14 mm	8,11	1	SBA7400DM-14
15 mm	8,22	1	SBA7400DM-15
16 mm	8,22	1	SBA7400DM-16
17 mm	8,22	1	SBA7400DM-17
18 mm	8,22	1	SBA7400DM-18
19 mm	8,22	1	SBA7400DM-19
20 mm	8,22	1	SBA7400DM-20
21 mm	8,31	1	SBA7400DM-21
22 mm	8,31	1	SBA7400DM-22

SB = Em embalagem individual num cartão informativo de plástico

Chaves de caixa de comp. standard, encaixe quadrado 3/8". Perfil sextavado, em polegadas



7400SZ

Size	Price	QTY	Part No.
1/4" in	7,22	1	7400SZ-1/4
5/16" in	7,22	1	7400SZ-5/16
11/32" in	7,45	1	7400SZ-11/32
3/8" in	7,22	1	7400SZ-3/8
7/16" in	7,34	1	7400SZ-7/16
1/2" in	7,34	1	7400SZ-1/2
9/16" in	7,34	1	7400SZ-9/16
5/8" in	7,45	1	7400SZ-5/8
11/16" in	7,45	1	7400SZ-11/16
3/4" in	7,45	1	7400SZ-3/4
13/16" in	7,45	1	7400SZ-13/16
7/8" in	7,45	1	7400SZ-7/8



Chave de caixa, 12 faces. Perfil bi-hexagonal, tamanhos em polegadas. De parede fina.



A7400DZ

€	SB	Q	Modelo
8,10	5	A7400DZ-1/4	
8,10	5	A7400DZ-5/16	
8,10	5	A7400DZ-3/8	
8,24	5	A7400DZ-7/16	
8,24	5	A7400DZ-1/2	
8,24	5	A7400DZ-17/32	
8,24	5	A7400DZ-9/16	
8,24	5	A7400DZ-19/32	
8,36	5	A7400DZ-5/8	
8,36	5	A7400DZ-11/16	
8,36	5	A7400DZ-3/4	
8,36	5	A7400DZ-13/16	
8,36	5	A7400DZ-7/8	
8,79	1	SBA7400DZ-1/4	
8,79	1	SBA7400DZ-5/16	
8,79	1	SBA7400DZ-3/8	
8,93	1	SBA7400DZ-7/16	
8,93	1	SBA7400DZ-1/2	
8,93	1	SBA7400DZ-17/32	
8,93	1	SBA7400DZ-9/16	
8,93	1	SBA7400DZ-19/32	
9,04	1	SBA7400DZ-5/8	
9,04	1	SBA7400DZ-11/16	
9,04	1	SBA7400DZ-3/4	
9,04	1	SBA7400DZ-13/16	
9,04	1	SBA7400DZ-7/8	

SB = Em embalagem individual num cartão informativo de plástico

Chave de caixa articulada, 12 faces. Perfil bi-hexagonal, tamanhos em polegadas. De parede fina.



A7410DZ

€	SB	Q	Modelo
39,41	1	A7410DZ-5/16	
40,80	1	A7410DZ-3/8	
40,80	1	A7410DZ-7/16	
40,80	1	A7410DZ-1/2	
40,80	1	A7410DZ-9/16	
45,55	1	A7410DZ-5/8	
45,55	1	A7410DZ-11/16	
45,55	1	A7410DZ-3/4	

Perfil bi-hexagonal, tamanhos em polegadas. De parede fina.

Chave de caixa série longa, 12 faces. Perfil bi-hexagonal, tamanhos em polegadas.



A7402DM

€	SB	Q	Modelo
14,91	1	A7402DM-7	
14,91	1	A7402DM-8	
14,92	1	A7402DM-9	
14,92	5	A7402DM-10	
14,92	1	A7402DM-11	
14,92	1	A7402DM-12	
14,92	1	A7402DM-13	
15,61	1	A7402DM-14	
15,61	1	A7402DM-15	
15,61	1	A7402DM-16	
16,64	1	A7402DM-17	
16,64	1	A7402DM-18	
16,64	1	A7402DM-19	
17,02	1	A7402DM-21	
15,58	1	SBA7402DM-7	
15,58	1	SBA7402DM-8	
15,60	1	SBA7402DM-9	
15,60	1	SBA7402DM-10	
15,60	1	SBA7402DM-11	
15,60	1	SBA7402DM-12	
15,60	1	SBA7402DM-13	
16,27	1	SBA7402DM-14	
16,27	1	SBA7402DM-15	
16,27	1	SBA7402DM-16	
17,33	1	SBA7402DM-17	
17,33	1	SBA7402DM-18	
17,33	1	SBA7402DM-19	

SB = Em embalagem individual num cartão informativo de plástico

Chave de caixa série longa, 12 faces. Perfil bi-hexagonal, tamanhos em polegadas.



A7402DZ

€	SB	Q	Modelo
16,76	1	A7402DZ-1/4	
16,76	1	A7402DZ-5/16	
16,76	1	A7402DZ-3/8	
16,76	1	A7402DZ-7/16	
16,76	1	A7402DZ-1/2	
16,76	1	A7402DZ-9/16	
16,76	1	A7402DZ-19/32	
16,76	1	A7402DZ-5/8	
16,76	1	A7402DZ-11/16	
16,76	1	A7402DZ-3/4	
16,76	1	A7402DZ-13/16	

€	SB	Q	Modelo
16,76	1	A7402DZ-7/8	
17,41	1	SBA7402DZ-1/4	
17,41	1	SBA7402DZ-5/16	
17,41	1	SBA7402DZ-3/8	
17,41	1	SBA7402DZ-7/16	
17,41	1	SBA7402DZ-1/2	
17,41	1	SBA7402DZ-9/16	
17,41	1	SBA7402DZ-19/32	
17,41	1	SBA7402DZ-5/8	
17,41	1	SBA7402DZ-11/16	
17,41	1	SBA7402DZ-3/4	
17,41	1	SBA7402DZ-13/16	
17,41	1	SBA7402DZ-7/8	

SB = Em embalagem individual num cartão informativo de plástico

Chave de caixa, TORX®



7400TORX-E

€	SB	Q	Modelo
10,88	5	7400TORX-E8	
10,88	5	7400TORX-E10	
10,88	5	7400TORX-E11	
10,88	5	7400TORX-E12	
11,89	5	7400TORX-E14	
11,89	5	7400TORX-E16	
12,48	5	7400TORX-E18	
11,57	1	SB7400TORX-E8	
11,57	1	SB7400TORX-E10	
11,57	1	SB7400TORX-E11	
11,57	1	SB7400TORX-E12	
12,56	1	SB7400TORX-E14	
12,56	1	SB7400TORX-E16	
13,15	1	SB7400TORX-E18	

SB = Em embalagem individual num cartão informativo de plástico

Manivela



7752

€	SB	Q	Modelo
46,86	1	7752	

Cabo articulado 3/8"



7758

L	€	SB	Q	Ref
250 m	29,03	1	1	7758-10
250 m	30,48	1	1	SB7758-10

SB = Em embalagem individual num cartão informativo de plástico

Cabo corrediço em T



7754

L	€	SB	Q	Ref
160 mm	18,09	1	1	7754
160 mm	18,77	1	1	SB7754

SB = Em embalagem individual num cartão informativo de plástico

Extensão com cabo. Transmissão quadrado fêmea 3/8" na extremidade



7756

L	€	SB	Q	Ref
150 mm	18,36	6	1	7756
150 mm	18,93	1	1	SB7756

Transmissão quadrado fêmea 3/8" na extremidade

Extensores



7760-7761-7762

L	€	SB	Q	Ref
75 mm	12,84	1	1	7760
127 mm	15,37	1	1	7761
250 mm	19,01	1	1	7762
75 mm	13,72	1	1	SB7760
127 mm	16,19	1	1	SB7761
252 mm	19,90	1	1	SB7762

Extensores tipo "Wobbler".



7760-W - 7761-W

L	€	SB	Q	Ref
75 mm	11,19	10	10	7760W-3
150 mm	12,44	10	10	7760W-6

Barras de extensão estriadas de 3/8"



776EX

L	€	SB	Q	Ref
26 mm	12,20	1	1	776EX-01
76 mm	12,20	1	1	776EX-03
101 mm	14,05	1	1	776EX-04
150 mm	15,22	1	1	776EX-06
200 mm	15,90	1	1	776EX-08
275 mm	16,91	1	1	776EX-11

Extensão flexível

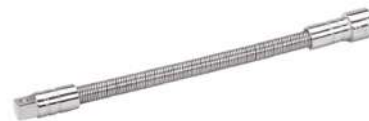

7759

L	€	SB	Q	Ref
200 mm	40,59	1	1	7759
200 mm	41,27	1	1	SB7759

Cardan universal



7766

L	€	SB	Q	Ref
51.5 mm	29,34	1	1	7766
51.5 mm	30,00	1	1	SB7766

SB = Em embalagem individual num cartão informativo de plástico

Cardan universal 3/8', operação suave



7768

L	€	SB	Q	Ref
45 mm	41,54	1	1	7768



Adaptador redutor de 3/8" a 1/4"



7764

3/8	1/4	€	📦	🐟
3/8	1/4	12,29	1	7764
3/8	1/4	12,97	1	SB7764

Adaptadores para chave quadrada 3/8" para pontas de chave de parafusos sextavadas 1/4"



SBS780

1/4 in	€	📦	🐟
1/4 in	2,99	20	7773A
1/4 in	2,32	1	SB7773A

Roquete reversível 3/8". 72 dentes/5° de ângulo de ação. Cabeça esguia para espaços estreitos. Cabeça estreita para espaços apertados.



7750SL

204 mm	72	€	📦	🐟
204 mm	72	58,52	1	7750SL

Cabeça estreita para espaços apertados.

Adaptador extensor de 3/8" a 1/2"



8164-1/2

3/8"	1/2"	€	📦	🐟
3/8"	1/2"	12,29	1	8164-1/2

Adaptador 3/8" para bits 5/16"



7106J

5/16 in	€	📦	🐟
5/16 in	8,53	1	7106J

Roquete reversível 3/8" de 80 dentes/ Ângulo de ação de 4.5°. Selado.



7750

207 mm	80	€	📦	🐟
207 mm	80	55,34	1	7750
207 mm	80	58,94	1	SB7750

80 dentes/ Ângulo de ação de 4.5°. Selado.

Adaptador extensor magnetizado de 3/8" a 1/2". Com ímã no disco



8167

3/8	1/2	€	📦	🐟
3/8	1/2	28,35	1	8167

Com ímã no disco

Railes e clips 3/8"



C3/8

19 mm	€	📦	🐟
19 mm	0,37	25	CLIPS-3/8

Roquete reversível Redondo 3/8" 72 dentes



7750RN

206 mm	72	€	📦	🐟
206 mm	72	52,45	1	7750RN
206 mm	72	53,14	1	SB7750RN

Roquete reversível. embalagem unitária



SBS750

		€		
200 mm	60	33,63	10	SBS750

SB = Em embalagem individual

Roquete de cabeça articulada



8120-3/8

		€		
223 mm	72	46,69	10	8120-3/8

Roquete reversível articulado de 60 dentes



7710

		€		
278 mm	60	76,83	1	7710

Chaves de caixa p/ parafusos de fenda



7409F

	€		
6.4 mm	6,54	5	7409F-6.5
7.9 mm	6,54	5	7409F-8
9.5 mm	6,54	5	7409F-10
6.4 mm	7,24	1	SB7409F-6.5
7.9 mm	7,24	1	SB7409F-8
9.5 mm	7,24	1	SB7409F-10

SB = Em embalagem individual num cartão informativo de plástico

Chaves de caixa p/parafusos PHILLIPS®



7409PH

	€		
1	6,89	5	7409PH-1
2	6,89	5	7409PH-2
3	6,89	5	7409PH-3
1	7,56	1	SB7409PH-1
2	7,56	1	SB7409PH-2
3	7,56	1	SB7409PH-3

SB = Em embalagem individual num cartão informativo de plástico

Chaves de caixa p/ parafusos TORX®, série longa



7409TORX

	€		
T20	11,72	5	7409TORX-T20
T25	11,72	5	7409TORX-T25
T27	11,72	5	7409TORX-T27

	€		
T30	11,72	5	7409TORX-T30
T40	14,21	5	7409TORX-T40
T45	14,21	5	7409TORX-T45
T50	14,21	5	7409TORX-T50
T20	12,40	1	SB7409TORX-T20
T25	12,40	1	SB7409TORX-T25
T27	12,40	1	SB7409TORX-T27
T30	12,40	1	SB7409TORX-T30
T40	14,86	1	SB7409TORX-T40
T45	14,86	1	SB7409TORX-T45
T50	14,86	1	SB7409TORX-T50

SB = Em embalagem individual num cartão informativo de plástico

Chaves de caixa p/ parafusos TORX® TAMPER RESISTANT



7409TORX-R

	€		
TR 27	13,00	5	7409TORX-R-T27
TR 30	13,00	5	7409TORX-R-T30
TR 40	15,29	5	7409TORX-R-T40
TR 45	15,60	5	7409TORX-R-T45
TR 50	16,23	5	7409TORX-R-T50
TR 27	13,68	1	SB7409TORX-R-T27
TR 30	13,68	1	SB7409TORX-R-T30
TR 40	15,98	1	SB7409TORX-R-T40
TR 45	16,25	1	SB7409TORX-R-T45
TR 50	16,93	1	SB7409TORX-R-T50

SB = Em embalagem individual num cartão informativo de plástico

Jogo de 5 chaves de caixa em rail



7409TORX-TRR/

		€		
5	25 x 55 x 190 mm	70,25	1	7409TORX-TRR/S5

7409TORX-R-T40, 7409TORX-R-T30, 7409TORX-R-T27, 7409TORX-R-T50, 7409TORX-R-T45



Chave de caixa p/ parafusos Torx série longa



7409TORX-L

	€		
T25	19,05	5	7409TORX-T25-L
T30	19,05	5	7409TORX-T30-L
T40	22,28	5	7409TORX-T40-L
T45	22,28	5	7409TORX-T45-L
T50	22,28	5	7409TORX-T50-L
T25	19,73	1	SB7409TORX-T25-L
T30	19,73	1	SB7409TORX-T30-L
T40	22,94	1	SB7409TORX-T40-L
T45	22,94	1	SB7409TORX-T45-L
T50	22,94	1	SB7409TORX-T50-L

SB = Em embalagem individual num cartão informativo de plástico

Chaves de caixa sextavado interior, série curta. Tamanhos métricos.



7409M

	€		
3 mm	10,62	5	7409M-3
4 mm	10,62	5	7409M-4
5 mm	10,62	5	7409M-5
6 mm	10,62	5	7409M-6
7 mm	10,62	5	7409M-7
8 mm	11,63	5	7409M-8
10 mm	11,63	5	7409M-10
3 mm	11,29	1	SB7409M-3
4 mm	11,29	1	SB7409M-4
5 mm	11,29	1	SB7409M-5
6 mm	11,29	1	SB7409M-6
7 mm	11,29	1	SB7409M-7
8 mm	12,29	1	SB7409M-8
10 mm	12,29	1	SB7409M-10

SB = Em embalagem individual num cartão informativo de plástico

Chaves de caixa sextavado interior, ponta esférica



7409BH

	€		
4 mm	11,40	5	7409BH-4
5 mm	11,40	1	7409BH-5
6 mm	11,40	5	7409BH-6

BAHCO

€

8 mm	12,36	5	7409BH-8
10 mm	14,01	5	7409BH-10
4 mm	12,06	1	SB7409BH-4
5 mm	12,06	1	SB7409BH-5
6 mm	12,06	1	SB7409BH-6
8 mm	13,03	1	SB7409BH-8
10 mm	14,68	1	SB7409BH-10

SB = Em embalagem individual num cartão informativo de plástico

chave de caixas de passagem de 19 mm com perfil estriado métrico



SBS19-TH

	€		
10 mm	5,70	1	SBS19-TH10
11 mm	5,70	1	SBS19-TH11
12 mm	5,70	1	SBS19-TH12
13 mm	5,70	1	SBS19-TH13
14 mm	5,88	1	SBS19-TH14
15 mm	5,88	1	SBS19-TH15
16 mm	5,88	1	SBS19-TH16
17 mm	6,72	1	SBS19-TH17
18 mm	6,72	1	SBS19-TH18
19 mm	6,72	1	SBS19-TH19
21 mm	7,39	1	SBS19-TH21
22 mm	7,39	1	SBS19-TH22
24 mm	7,95	1	SBS19-TH24

SB = Em embalagem individual

Roquete quadrado de 3/8", para parafusos sextavados. Em polegadas



7409Z

	L	€		
1/8 in	47 mm	9,57	1	7409Z-1/8
5/32 in	47 mm	9,57	1	7409Z-5/32
3/16 in	47 mm	9,57	1	7409Z-3/16
7/32 in	47 mm	9,57	1	7409Z-7/32
1/4 in	47 mm	9,57	1	7409Z-1/4
3/8 in	50.5 mm	10,48	1	7409Z-3/8

19 mm Passar por uma extensão de 75 mm



SBS19-TH75

L	€		
75 mm	9,70	1	SBS19-TH75

Jogo de 7 chaves de caixa em rail



7409MR/

	€		
7 25 x 55 x 190 mm	77,17	1	7409MR/S7

7409M-3, 7409M-4, 7409M-10, 7409M-8, 7409M-7, 7409M-6, 7409M-5

Adaptador de roquete reversível de 3/8



7751

L	g	€		
55 mm	175 g	43,97	10	7751

Acessórios para roquete 3/8' 7750SL



7750SL-SPARE

	€		
12 7750SL	18,58	1	7750SL-SPARE

Accesórios para roquete 3/8' 7750



7750-SPARE

Quantidade	Referência	Preço	Embalagem	Descrição
11	7750	20,43	1	7750-SPARE

Accesórios para roquete 3/8' 7750RN



7750RN-SPARE

Quantidade	Referência	Preço	Embalagem	Descrição
6	7750RN	17,62	1	7750RN-SPARE

1/2"

Chave de caixa, 6 faces. Perfil hexagonal, tamanhos métricos.



7800SM

Diâmetro	Preço	Embalagem	Descrição
8 mm	6,40	10	7800SM-8
9 mm	6,52	10	7800SM-9
10 mm	6,52	10	7800SM-10
11 mm	6,52	10	7800SM-11
12 mm	6,90	10	7800SM-12
13 mm	7,20	10	7800SM-13
14 mm	7,58	10	7800SM-14
15 mm	7,85	10	7800SM-15

Diâmetro	Preço	Embalagem	Descrição
16 mm	8,00	10	7800SM-16
17 mm	8,32	10	7800SM-17
18 mm	8,32	10	7800SM-18
19 mm	8,64	10	7800SM-19
20 mm	9,07	10	7800SM-20
21 mm	9,12	10	7800SM-21
22 mm	9,45	10	7800SM-22
23 mm	9,93	10	7800SM-23
24 mm	10,65	10	7800SM-24
25 mm	10,82	10	7800SM-25
26 mm	11,04	10	7800SM-26
27 mm	11,34	10	7800SM-27
28 mm	12,17	10	7800SM-28
29 mm	12,64	10	7800SM-29
30 mm	12,64	10	7800SM-30
32 mm	12,89	10	7800SM-32
33 mm	11,57	10	7800SM-33
34 mm	17,25	10	7800SM-34
36 mm	24,44	10	7800SM-36
8 mm	7,58	1	SB7800SM-8
9 mm	7,72	1	SB7800SM-9
10 mm	7,72	1	SB7800SM-10
11 mm	7,72	1	SB7800SM-11
12 mm	8,06	1	SB7800SM-12
13 mm	8,36	1	SB7800SM-13
14 mm	8,73	1	SB7800SM-14
15 mm	9,01	1	SB7800SM-15
16 mm	9,18	1	SB7800SM-16
17 mm	9,50	1	SB7800SM-17
18 mm	9,50	1	SB7800SM-18
19 mm	9,82	1	SB7800SM-19
21 mm	9,77	1	SB7800SM-20
21 mm	10,29	1	SB7800SM-21
22 mm	10,60	1	SB7800SM-22
23 mm	11,10	1	SB7800SM-23
24 mm	11,81	1	SB7800SM-24
25 mm	11,98	1	SB7800SM-25
26 mm	12,20	1	SB7800SM-26
27 mm	12,53	1	SB7800SM-27
28 mm	13,35	1	SB7800SM-28
29 mm	13,35	1	SB7800SM-29
30 mm	13,81	1	SB7800SM-30
32 mm	14,08	1	SB7800SM-32
33 mm	13,59	1	SB7800SM-33
34 mm	17,93	1	SB7800SM-34
36 mm	25,12	1	SB7800SM-36

SB = Em embalagem individual num cartão informativo de plástico

Chave de caixa série longa, 6 faces. Perfil hexagonal, tamanhos métricos.



7805SM

Diâmetro	Preço	Embalagem	Descrição
10 mm	17,47	10	7805SM-10
11 mm	17,47	10	7805SM-11
12 mm	17,47	10	7805SM-12
13 mm	17,47	10	7805SM-13
14 mm	18,20	10	7805SM-14

Diâmetro	Preço	Embalagem	Descrição
15 mm	19,16	10	7805SM-15
16 mm	19,66	10	7805SM-16
17 mm	19,66	10	7805SM-17
18 mm	19,66	10	7805SM-18
19 mm	19,66	10	7805SM-19
20 mm	20,11	10	7805SM-20
21 mm	21,91	10	7805SM-21
22 mm	22,08	10	7805SM-22
23 mm	22,78	10	7805SM-23
24 mm	22,78	10	7805SM-24
25 mm	22,00	10	7805SM-25
26 mm	22,78	10	7805SM-26
27 mm	25,24	10	7805SM-27
28 mm	23,54	10	7805SM-28
29 mm	25,12	10	7805SM-29
30 mm	26,99	10	7805SM-30
32 mm	29,20	10	7805SM-32
34 mm	29,20	10	7805SM-34
10 mm	18,14	1	SB7805SM-10
11 mm	12,51	1	SB7805SM-11
12 mm	18,14	1	SB7805SM-12
13 mm	18,14	1	SB7805SM-13
14 mm	18,88	1	SB7805SM-14
15 mm	19,85	1	SB7805SM-15
16 mm	20,34	1	SB7805SM-16
17 mm	20,34	1	SB7805SM-17
18 mm	20,34	1	SB7805SM-18
19 mm	20,34	1	SB7805SM-19
20 mm	21,07	1	SB7805SM-20
21 mm	22,60	1	SB7805SM-21
22 mm	22,78	1	SB7805SM-22
23 mm	23,47	1	SB7805SM-23
24 mm	23,47	1	SB7805SM-24
25 mm	23,47	1	SB7805SM-25
26 mm	23,47	1	SB7805SM-26
27 mm	25,89	1	SB7805SM-27
28 mm	24,17	1	SB7805SM-28
29 mm	25,82	1	SB7805SM-29
30 mm	27,66	1	SB7805SM-30
32 mm	29,89	1	SB7805SM-32
34 mm	32,67	1	SB7805SM-34

SB = Em embalagem individual num cartão informativo de plástico

Chaves de caixa série longa, encaixe quadrado de 1/2". Perfil hexagonal, tamanhos AF



7805SZ

Diâmetro	Preço	Embalagem	Descrição
1.3/16 in	22,99	1	7805SZ-1.3/16
1.1/4 in	24,39	1	7805SZ-1.1/4
1.5/16 in	26,33	1	7805SZ-1.5/16
1.3/8 in	28,04	1	7805SZ-1.3/8
1.7/16 in	44,78	1	7805SZ-1.7/16
1.1/2 in	44,78	1	7805SZ-1.1/2



Chave de caixa, 12 faces. Perfil bi-hexagonal, tamanhos métricos.



7800DM

Ø	€	SB	Icon
8 mm	6,40	10	7800DM-8
9 mm	6,40	10	7800DM-9
10 mm	6,40	10	7800DM-10
11 mm	6,52	10	7800DM-11
12 mm	6,90	10	7800DM-12
13 mm	7,20	10	7800DM-13
14 mm	7,58	10	7800DM-14
15 mm	7,85	10	7800DM-15
16 mm	8,00	10	7800DM-16
17 mm	8,32	10	7800DM-17
18 mm	8,32	10	7800DM-18
19 mm	8,64	10	7800DM-19
20 mm	8,88	10	7800DM-20
21 mm	9,12	10	7800DM-21
22 mm	9,45	10	7800DM-22
23 mm	9,93	10	7800DM-23
24 mm	10,65	10	7800DM-24
25 mm	10,82	10	7800DM-25
26 mm	11,04	10	7800DM-26
27 mm	11,34	10	7800DM-27
28 mm	12,17	10	7800DM-28
29 mm	12,49	10	7800DM-29
30 mm	12,64	10	7800DM-30
31 mm	12,85	10	7800DM-31
32 mm	13,14	10	7800DM-32
33 mm	11,57	10	7800DM-33
34 mm	16,49	10	7800DM-34
36 mm	24,89	10	7800DM-36
8 mm	7,58	1	SB7800DM-8
9 mm	7,58	1	SB7800DM-9
10 mm	7,58	1	SB7800DM-10
11 mm	7,69	1	SB7800DM-11
12 mm	8,06	1	SB7800DM-12
13 mm	8,36	1	SB7800DM-13
14 mm	8,73	1	SB7800DM-14
15 mm	9,01	1	SB7800DM-15
16 mm	9,18	1	SB7800DM-16
17 mm	9,50	1	SB7800DM-17
18 mm	9,50	1	SB7800DM-18
19 mm	9,82	1	SB7800DM-19
21 mm	10,05	1	SB7800DM-20
21 mm	10,29	1	SB7800DM-21
22 mm	10,60	1	SB7800DM-22
23 mm	11,10	1	SB7800DM-23
24 mm	11,81	1	SB7800DM-24
25 mm	11,98	1	SB7800DM-25
26 mm	12,20	1	SB7800DM-26
27 mm	12,53	1	SB7800DM-27
28 mm	13,35	1	SB7800DM-28
29 mm	13,66	1	SB7800DM-29
30 mm	13,81	1	SB7800DM-30
31 mm	14,17	1	SB7800DM-31
32 mm	14,32	1	SB7800DM-32
33 mm	12,22	1	SB7800DM-33
34 mm	17,16	1	SB7800DM-34
36 mm	26,12	1	SB7800DM-36

SB = Em embalagem individual num cartão informativo de plástico

Chave de caixa, 12 faces. Perfil bi-hexagonal, tamanhos em polegadas.



7800DZ

Ø	€	SB	Icon
5/16 in	8,09	10	7800DZ-5/16
11/32 in	8,09	10	7800DZ-11/32
3/8 in	6,55	10	7800DZ-3/8
13/32 in	8,09	10	7800DZ-13/32
7/16 in	6,73	10	7800DZ-7/16
1/2 in	7,39	10	7800DZ-1/2
9/16 in	7,87	10	7800DZ-9/16
19/32 in	8,09	10	7800DZ-19/32
5/8 in	8,32	10	7800DZ-5/8
11/16 in	8,55	10	7800DZ-11/16
3/4 in	8,97	10	7800DZ-3/4
25/32 in	9,12	10	7800DZ-25/32
13/16 in	9,45	10	7800DZ-13/16
7/8 in	9,77	10	7800DZ-7/8
15/16 in	10,96	10	7800DZ-15/16
1 in	11,04	10	7800DZ-1
1 1/16 in	11,68	10	7800DZ-1.1/16
1 1/8 in	12,42	10	7800DZ-1.1/8
1 3/16 in	13,13	10	7800DZ-1.3/16
1 1/4 in	13,29	10	7800DZ-1.1/4
1.5/16 in	11,65	10	7800DZ-1.5/16
1.3/8 in	11,65	10	7800DZ-1.3/8
1.7/16 in	12,12	1	7800DZ-1.7/16
1.1/2 in	11,22	10	7800DZ-1.1/2
3/8 in	7,25	1	SB7800DZ-3/8
7/16 in	7,40	1	SB7800DZ-7/16
1/2 in	8,07	1	SB7800DZ-1/2
9/16 in	8,55	1	SB7800DZ-9/16
19/32 in	8,78	1	SB7800DZ-19/32
5/8 in	9,01	1	SB7800DZ-5/8
11/16 in	9,25	1	SB7800DZ-11/16
3/4 in	9,65	1	SB7800DZ-3/4
25/32 in	9,81	1	SB7800DZ-25/32
13/16 in	10,13	1	SB7800DZ-13/16
7/8 in	10,44	1	SB7800DZ-7/8
15/16 in	11,65	1	SB7800DZ-15/16
1 in	11,72	1	SB7800DZ-1
1.1/16 in	12,37	1	SB7800DZ-1.1/16
1.1/8 in	13,08	1	SB7800DZ-1.1/8
1.3/16 in	13,82	1	SB7800DZ-1.3/16
1.1/4 in	13,96	1	SB7800DZ-1.1/4
1 5/16 in	13,74	1	SB7800DZ-1.5/16

SB = Em embalagem individual num cartão informativo de plástico

Chave de caixa, Perfil Hexagonal, tamanhos em polegadas.



7800SZ

Ø	€	SB	Icon
3/8 in	4,41	10	7800SZ-3/8
7/16 in	4,58	10	7800SZ-7/16
1/2 in	7,39	10	7800SZ-1/2
9/16 in	4,64	10	7800SZ-9/16
11/16 in	5,41	10	7800SZ-11/16
3/4 in	5,61	10	7800SZ-3/4
13/16 in	5,71	10	7800SZ-13/16
7/8 in	6,05	10	7800SZ-7/8
1 3/16 in	7,79	10	7800SZ-1.3/16

Perfil hexagonal, tamanhos em polegadas.

Chave de caixa série longa, 12 faces. Perfil bi-hexagonal, tamanhos métricos.



7805DM

Ø	€	SB	Icon
10 mm	17,14	10	7805DM-10
12 mm	17,14	10	7805DM-12
13 mm	17,14	10	7805DM-13
14 mm	17,92	10	7805DM-14
15 mm	18,83	10	7805DM-15
16 mm	19,37	10	7805DM-16
17 mm	19,37	10	7805DM-17
18 mm	19,37	10	7805DM-18
19 mm	19,37	10	7805DM-19
21 mm	21,52	10	7805DM-21
22 mm	21,73	10	7805DM-22
23 mm	21,80	10	7805DM-23
24 mm	22,38	10	7805DM-24
26 mm	22,38	10	7805DM-26
27 mm	24,80	10	7805DM-27
30 mm	26,52	10	7805DM-30
32 mm	27,18	10	7805DM-32
34 mm	27,18	10	7805DM-34
10 mm	17,84	1	SB7805DM-10
12 mm	17,84	1	SB7805DM-12
13 mm	17,84	1	SB7805DM-13
14 mm	18,59	1	SB7805DM-14
15 mm	19,51	1	SB7805DM-15
16 mm	20,06	1	SB7805DM-16
17 mm	20,06	1	SB7805DM-17
18 mm	20,06	1	SB7805DM-18
19 mm	20,06	1	SB7805DM-19
21 mm	22,20	1	SB7805DM-21
22 mm	22,39	1	SB7805DM-22
23 mm	22,44	1	SB7805DM-23

Ø	€		
24 mm	23,06	1	SB7805DM-24
26 mm	23,06	1	SB7805DM-26
27 mm	25,49	1	SB7805DM-27
30 mm	27,22	1	SB7805DM-30
32 mm	27,83	1	SB7805DM-32
34 mm	21,68	1	SB7805DM-34

SB = Em embalagem individual num cartão informativo de plástico

Chaves de caixa série longa, encaixe quadrado de 1/2". Perfil bi-hexagonal, tamanhos AF



7805DZ

Ø	€		
5/8 in	16,77	10	7805DZ-5/8
11/16 in	16,77	10	7805DZ-11/16
3/4 in	16,77	10	7805DZ-3/4
13/16 in	18,65	10	7805DZ-13/16
7/8 in	18,82	10	7805DZ-7/8
15/16 in	19,41	10	7805DZ-15/16
1 in	20,34	10	7805DZ-1
1.1/16 in	21,50	10	7805DZ-1.1/16
1.1/8 in	24,11	10	7805DZ-1.1/8
1.13/16 in	22,99	10	7805DZ-1.3/16
1.1/4 in	24,39	10	7805DZ-1.1/4
1.5/16 in	26,33	10	7805DZ-1.5/16
1.3/8 in	28,04	10	7805DZ-1.3/8
1.7/16 in	44,78	10	7805DZ-1.7/16
1.1/2 in	44,78	10	7805DZ-1.1/2

Chave de caixa para parafusos, externo. Para parafusos TORX®.



7800TORX-E

Ø	€		
E8	9,25	1	7800TORX-E8
E10	10,40	1	7800TORX-E10
E11	10,40	1	7800TORX-E11
E12	10,40	1	7800TORX-E12
E14	10,40	1	7800TORX-E14
E16	10,56	1	7800TORX-E16
E18	10,56	1	7800TORX-E18
E20	11,13	1	7800TORX-E20
E24	12,23	1	7800TORX-E24
E8	9,93	1	SB7800TORX-E8
E10	11,10	1	SB7800TORX-E10
E11	11,10	1	SB7800TORX-E11
E12	11,10	1	SB7800TORX-E12

Ø	€		
E14	11,10	1	SB7800TORX-E14
E16	11,24	1	SB7800TORX-E16
E18	11,24	1	SB7800TORX-E18
E20	11,81	1	SB7800TORX-E20
E24	12,92	1	SB7800TORX-E24

SB = Em embalagem individual num cartão informativo de plástico

Manivela



8152-1/2

L	€		
425 mm	47,45	1	8152-1/2

Cabo articulado



8157

L	€		
257 mm	94,59	1	8157-10
390 mm	55,01	1	8157-15
600 mm	86,50	1	8157-24
900 mm	132,68	10	8157-36
257 mm	95,73	1	SB8157-10
390 mm	56,16	1	SB8157-15
600 mm	96,78	1	SB8157-24
900 mm	133,82	1	SB8157-36

Extensão articulada de 1/2"



8158

L	€		
270 mm	30,39	1	8158-10
390 mm	32,45	1	8158-15
270 mm	34,69	1	SB8158-10
390 mm	44,22	1	SB8158-15

Cabo L 1/2"



8167-1/2

L	€		
180 mm	15,66	10	8167

Cabo em T



8154

L	€		
280 mm	24,01	1	SB8154-11
280 mm	19,02	10	8154-11

Adaptador de cabeça deslizante 3/8" para 1/2"



7772H

Ø	Ø	€		
3/8"	1/2"	3,11	10	7772H

Extensões



8160

L	€		
75 mm	12,50	10	8160-3
125 mm	14,74	10	8160-5
250 mm	18,57	10	8160-10
75 mm	16,42	1	SB8160-3
125 mm	11,07	1	SB8160-5
250 mm	19,85	1	SB8160-10



Extensores tipo "Wobblers".



8159-W - 8162-W

L	€	10	8160W-3
75 mm	16,16	10	8160W-3
125 mm	16,96	10	8160W-5
250 mm	21,29	10	8160W-10

Cardan universal 1/2", operação suave



8168

L	€	1	8168
62 mm	38,32	1	8168

Adaptador extensor de 1/2" a 3/4"



8172

1/2"	3/4"	€	10	8172
1/2"	3/4"	20,18	10	8172
1/2"	3/4"	23,33	1	SB8172

Extensão com bloqueio 1/2"



8160-B

L	€	1	8160-B
125 mm	27,68	1	8160-B

Adaptador redutor de 1/2" a 3/8"



8171

1/2"	3/8"	€	10	8171
1/2"	3/8"	16,97	10	8171
1/2"	3/8"	19,85	1	SB8171

Adaptador extensor magnetizado de 1/2" a 3/4". Com íman no disco



8967

1/2	3/4	€	1	8967
1/2	3/4	32,65	1	8967

Com íman no disco

Cardan



8166

L	€	10	8166
72 mm	32,96	10	8166
72 mm	35,75	1	SB8166

Chave escalonada combinada. 5 passos diferentes: 3/8"-7/16"-1/2"-3/4"-1"



8195-key

g	€	50	8195-KEY
140 g	21,39	50	8195-KEY

Adaptador 1/2" para bits 5/16"



7106S

5/16 in	€	10	8174A
5/16 in	9,74	10	8174A

Adaptador de 1/2" para bits de 5/16"



7809HL

	€		
5/16 in	12,74	1	7809HL

Kit pcs substituição p/barra de torção de 1/2" 8169-1/2. E 8156-1/2, 8158-1/2 desde 2016. Roscado.



SP120

	€		
75 g	26,80	1	SP120

Kit pcs substituição p/barra de torção de 1/2" 8170-1/2



SP120XL

	€		
55 g	12,76	1	SP120XL

Railes e clips 3/8"



C1/2

	€		
19 mm	0,38	25	CLIPS-1/2

Chaves de caixa p/ parafusos de fenda



7809F

		€		
0.8 mm	8 mm	14,31	5	7809F-8
1 mm	10 mm	14,59	5	7809F-10

Chaves de caixa p/ parafusos PHILLIPS®



7809PH

	€		
2	12,46	1	7809PH-2
3	12,85	1	7809PH-3
4	12,85	1	7809PH-4

Chaves de caixa p/ parafusos POZIDRIV®



7809PZ

	€		
2	12,23	1	7809PZ-2
3	12,91	1	7809PZ-3

Chaves de caixa p/parafusos TORX®



7809TORX

	€		
T20	14,73	1	7809TORX-T20
T25	14,73	1	7809TORX-T25
T27	14,73	1	7809TORX-T27
T30	14,73	1	7809TORX-T30
T40	17,19	1	7809TORX-T40
T45	17,19	1	7809TORX-T45
T50	17,19	1	7809TORX-T50
T55	21,52	1	7809TORX-T55
T60	21,52	1	7809TORX-T60
T70	21,53	10	7809TORX-T70
T20	15,90	1	SB7809TORX-T20
T25	15,90	1	SB7809TORX-T25
T27	15,90	1	SB7809TORX-T27
T30	15,90	1	SB7809TORX-T30
T40	18,39	1	SB7809TORX-T40
T45	18,39	1	SB7809TORX-T45
T50	18,39	1	SB7809TORX-T50
T55	22,74	1	SB7809TORX-T55
T60	22,74	1	SB7809TORX-T60

SB = Em embalagem individual num cartão informativo de plástico



Chaves de caixa quadradas de 1/2" para parafusos de cabeça TORX® - longas



7809TORX L

		€		
T20	80 mm	20,09	1	7809TORX-T20-120
T25	80 mm	20,09	1	7809TORX-T25-120
T27	80 mm	20,09	1	7809TORX-T27-120
T30	80 mm	20,09	1	7809TORX-T30-120
T40	82 mm	21,97	1	7809TORX-T40-120
T45	80 mm	21,97	1	7809TORX-T45-120
T50	62 mm	21,97	1	7809TORX-T50-100
T55	80 mm	25,44	1	7809TORX-T55-120
T60	80 mm	25,44	1	7809TORX-T60-120
T70	102 mm	31,08	5	7809TORX-T70-140

Jogo de chaves de caixa 1/2' em calha



7809TO

	€		
9	151,67	1	7809TO

7809TORX-T27, 7809TORX-T20, 7809TORX-T25, 7809TORX-T30, 7809TORX-T50, 7809TORX-T40, 7809TORX-T45, 7809TORX-T60, 7809TORX-T55

Conjunto de chaves de fendas quadradas de 1/2" para parafusos de cabeça TORX® - 9 Pcs



7800TORX/9

	€		
800 g	93,01	1	7800TORX/9

7800TORX-E8, 7800TORX-E10, 7800TORX-E11, 7800TORX-E12, 7800TORX-E14, 7800TORX-E16, 7800TORX-E18, 7800TORX-E20, 7800TORX-E24

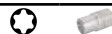

Chaves de caixa p/parafusos sextavados interior. Tamanhos métricos.



7809M

	€		
4 mm	12,98	10	7809M-4
5 mm	12,98	1	7809M-5
6 mm	12,98	1	7809M-6
7 mm	12,98	1	7809M-7
8 mm	14,08	1	7809M-8
9 mm	14,08	1	7809M-9
10 mm	14,08	1	7809M-10
12 mm	14,39	1	7809M-12
14 mm	14,42	1	7809M-14
17 mm	15,13	1	7809M-17
19 mm	15,55	1	7809M-19
4 mm	14,17	1	SB7809M-4
5 mm	14,17	1	SB7809M-5
6 mm	14,17	1	SB7809M-6
7 mm	14,17	1	SB7809M-7
8 mm	15,25	1	SB7809M-8
9 mm	15,25	1	SB7809M-9
10 mm	15,25	1	SB7809M-10
12 mm	15,58	1	SB7809M-12
14 mm	15,97	1	SB7809M-14
17 mm	16,48	1	SB7809M-17
19 mm	16,73	1	SB7809M-19

SB = Em embalagem individual num cartão informativo de plástico

Chaves de caixa quadradas de 1/2" para parafusos de cabeça sextavada - longas



7809M L

	€		
4 mm	80 mm	11,60	1 7809M-4-120
5 mm	80 mm	11,60	1 7809M-5-120
5 mm	143 mm	21,46	1 7809M-5-180
6 mm	80 mm	11,60	1 7809M-6-120

		€		
7 mm	63 mm	17,07	1	7809M-7-100
8 mm	83 mm	19,64	1	7809M-8-120
10 mm	80 mm	11,60	1	7809M-10-120
12 mm	80 mm	11,60	1	7809M-12-120
14 mm	80 mm	11,60	10	7809M-14-120
17 mm	80 mm	11,60	10	7809M-17-120
19 mm	80 mm	11,60	8	7809M-19-120
5 mm	140 mm	22,64	1	SB7809M-5-180
7 mm	63 mm	18,24	1	SB7809M-7-100
8 mm	81 mm	20,82	1	SB7809M-8-120

Chaves de impacto 1/2' para parafusos hexagonais



7808HM

	€		
8	110,36	1	7808HM

7809M-4, 7809M-6, 7809M-8, 7809M-7, 7809M-5, 7809M-10, 7809M-12, 7809M-14

Chaves de caixa p/parafusos sextavados interior. Tamanhos em polegadas.



7809Z

	€		
1/4 in	12,75	1	7809Z-3/16
5/16 in	12,75	1	7809Z-1/4
3/8 in	12,75	1	7809Z-5/16
7/16 in	13,11	1	7809Z-3/8
1/2 in	13,84	1	7809Z-7/16
17/32 in	14,31	1	7809Z-1/2
9/16 in	14,20	1	7809Z-17/32
19/32 in	14,56	1	7809Z-9/16
5/8 in	14,56	1	7809Z-19/32

Tamanhos em polegadas.

Parafusos múltiplos



7809XZN

	€		
6	18,08	1	7809XZN-6
8	18,20	1	7809XZN-8
8	19,91	1	7809XZN-8-100
10	19,10	1	7809XZN-10
10	23,61	1	7809XZN-10-100
12	23,61	1	7809XZN-12
12	25,79	1	7809XZN-12-100
14	25,23	1	7809XZN-14
14	29,51	1	7809XZN-14-100
16	27,65	1	7809XZN-16
18	29,46	1	7809XZN-18

Roquete reversível redondo 1/2" 72 dentes. Seta indicadora para mudar de direção. Patenteada.



8150RN-1/2

L		€	
267 mm	72	62,68	1 8150RN-1/2
267 mm	72	63,43	1 SB8150RN-1/2

Seta indicadora para mudar de direção. Patenteada.

Roquete reversível de 1/2



8195-R

L		€	
260 mm	60	52,93	1 8195-R

Roquete reversível 1/2". 72 dentes/5° de ângulo de ação. Cabeça esguia para espaços estreitos



8150SL

L		€	
264 mm	72	66,06	1 8150SL

Chave de roquete reversível 1/2". 60 dentes/ Ângulo de ação de 6°.



SBS81

L		€	
250 mm	60	41,04	5 SBS81

60 dentes/ Ângulo de ação de 6°.

Conjunto de roquetes para válvula do radiador



8195-SET

	€	
350 x 20 x 80 mm	64,47	5 8195-SET

- 8195-R
- 8195-SQ
- 8195-KEY

Roquete reversível 1/2" de 80 dentes. 80 dentes/ Ângulo de ação de 4.5°. Selado.



8150-1/2

L		€	
269 mm	80	64,90	1 8150-1/2
269 mm	80	65,66	1 SB8150-1/2

80 dentes/ Ângulo de ação de 4.5°. Selado.

Roquete de cabeça articulada



8120-1/2

L		€	
266 mm	72	60,28	12 8120-1/2

Roquete cabeça flexível 1/2"



8110H-1/2

L		€	
440 mm	32	99,97	1 8110H-1/2



Quadrado condutor para 8193-1/2



8194-1/2

	€		
32 mm	6,23	1	8194-1/2

Encaixe quadrado condutor para roquete 8195-R



8195-SQ

		€		
37.5 mm	40 g	5,68	25	8195-SQ

Adaptador para roquete, reversível de 60 dentes



8151-1/2

	€		
71 mm	85,37	1	8151-1/2

Kit de acessórios para roquete 1/2' 8150SL



8150SL-SPARE

		€		
12	8150SL	20,55	1	8150SL-SPARE

Acessórios para roquete 1/2' 8150-1/2



8150-1/2-SPARE

		€		
11	8150-1/2	30,58	1	8150-1/2-SPARE

Acessórios para roquete 1/2' 8150RN-1/2



8150RN-1/2-SPARE

		€		
6	8150RN-1/2	18,94	1	8150RN-1/2-SPARE

3/4"

Chave de caixa, 6 faces. Perfil hexagonal, tamanhos métricos.



8900SM

	€		
19 mm	18,03	1	8900SM-19
22 mm	18,03	1	8900SM-22
23 mm	18,03	1	8900SM-23
24 mm	19,35	5	8900SM-24
26 mm	19,61	5	8900SM-26
27 mm	19,99	5	8900SM-27
28 mm	19,99	1	8900SM-28
29 mm	22,40	1	8900SM-29
30 mm	22,40	5	8900SM-30
32 mm	23,36	5	8900SM-32
33 mm	23,36	1	8900SM-33
34 mm	24,85	1	8900SM-34
35 mm	24,85	1	8900SM-35
36 mm	27,02	5	8900SM-36
38 mm	28,75	1	8900SM-38
41 mm	31,68	5	8900SM-41
42 mm	31,68	1	8900SM-42
46 mm	37,38	1	8900SM-46
50 mm	42,60	1	8900SM-50
55 mm	51,25	1	8900SM-55
60 mm	56,98	1	8900SM-60

Perfil hexagonal, tamanhos métricos.

Chaves de caixa de comp. standard, encaixe quadrado 3/4". Perfil sextavado, em polegadas.



8900SZ

	€		
3/4 in	15,87	1	8900SZ-3/4
13/16 in	21,90	1	8900SZ-13/16
1 in	24,01	1	8900SZ-1
1.7/16 in	30,15	1	8900SZ-1.7/16
1.9/16 in	31,41	1	8900SZ-1.9/16
1.7/8 in	41,76	1	8900SZ-1.7/8
2 in	45,50	1	8900SZ-2

Chave de caixa, 12 faces. Perfil bi-hexagonal, tamanhos métricos.



8900DM

	€		
19 mm	17,79	1	8900DM-19
21 mm	15,36	5	8900DM-21
22 mm	18,31	1	8900DM-22
23 mm	17,34	1	8900DM-23
24 mm	19,61	1	8900DM-24
25 mm	19,05	1	8900DM-25
26 mm	17,19	1	8900DM-26
27 mm	19,99	1	8900DM-27
28 mm	20,97	1	8900DM-28
29 mm	19,72	1	8900DM-29
30 mm	22,40	5	8900DM-30
32 mm	23,36	1	8900DM-32
33 mm	22,99	1	8900DM-33
34 mm	24,85	1	8900DM-34
35 mm	22,99	1	8900DM-35
36 mm	27,02	1	8900DM-36
37 mm	27,70	1	8900DM-37
38 mm	31,72	1	8900DM-38
40 mm	34,12	1	8900DM-40
41 mm	31,68	5	8900DM-41
42 mm	34,11	1	8900DM-42
46 mm	37,38	1	8900DM-46
47 mm	35,06	1	8900DM-47
50 mm	42,59	5	8900DM-50
52 mm	44,66	1	8900DM-52
40 mm	44,66	3	8900DM-54
55 mm	51,26	1	8900DM-55
56 mm	52,29	1	8900DM-56
60 mm	56,98	5	8900DM-60

Perfil bi-hexagonal, tamanhos métricos.

Chave de caixa, 12 faces. Perfil bi-hexagonal, tamanhos em polegadas.



8900DZ

	€		
3/4 in	12,52	1	8900DZ-3/4
13/16 in	16,33	1	8900DZ-13/16
7/8 in	19,83	1	8900DZ-7/8
15/16 in	19,58	1	8900DZ-15/16
31/32 in	22,56	1	8900DZ-31/32
1 in	19,74	1	8900DZ-1
1 1/16 in	20,39	1	8900DZ-1.1/16
1 1/8 in	21,38	1	8900DZ-1.1/8
1 1/4 in	23,63	1	8900DZ-1.1/4
1 5/16 in	25,63	5	8900DZ-1.5/16
1 3/8 in	25,63	1	8900DZ-1.3/8
1 1/2 in	28,97	1	8900DZ-1.1/2
1.9/16 in	33,47	1	8900DZ-1.9/16
1 5/8 in	32,63	1	8900DZ-1.5/8
1.11/16 in	33,86	1	8900DZ-1.11/16
1 3/4 in	37,86	1	8900DZ-1.3/4
1 13/16 in	37,86	1	8900DZ-1.13/16

	€		
1 7/8 in	43,12	1	8900DZ-1.7/8
2 in	43,12	1	8900DZ-2
2.1/16 in	43,01	1	8900DZ-2.1/16
2.1/8 in	43,02	1	8900DZ-2.1/8
2.3/16 in	48,95	1	8900DZ-2.3/16
2.1/4 in	44,90	1	8900DZ-2.1/4
2.3/8 in	54,09	1	8900DZ-2.3/8

Perfil bi-hexagonal, tamanhos em polegadas.

Pega telescópica para chave quadrada 3/4" com acabamento mate



8953E-32

	€		
495 to 810 mm	77,97	1	8953E-32

Cabo Universal para 8952N/A



8952N/B

	€		
450 mm	23,43	1	8952N/B

Cabo em T. Consiste em cabo universal 8953 e cabeça corrediça 8954A.



8954

	€		
390 mm	69,22	1	8954-15

Consiste em cabo universal 8953 e cabeça corrediça 8954A.

Cabeça corrediça para 8953. Juntamente com cabo universal 8953 completa o cabo corrediço em T 8954.



8954A

	€		
62 mm	36,66	1	8954A

Juntamente com cabo universal 8953 completa o cabo corrediço em T 8954.

Barras de disjuntor de cabeça flexível de acionamento quadrado de 3/4"



8957-19

	€		
480 mm	94,25	1	8957-19

Cabeça articulada. Juntamente com cabo universal 8953 completa o roquete reversível 8958.



8958A

	€		
125 mm	92,95	1	8958A

Juntamente com cabo universal 8953 completa o roquete reversível 8958.

Cabeças flexíveis de acionamento quadrado de 3/4" para a barra de corte 8957



8957A

	€		
140 mm	76,50	1	8957A

Cabo em L 3/4"



8963

	€		
415 mm	39,56	1	8963



Extensões



8961/8962

← L →	€		
200 mm	39,03	1	8960-8
400 mm	48,62	12	8960-16

Adaptador extensor de 3/4" a 1"



9564

		€		
3/4"	1"	29,82	1	8972

Cabeça de roquete reversível de 72 dentes. Juntamente com cabo universal 8953 torna-se no Roquete completo 8950N.



8950N/A

← L →		€		
170 mm	72	113,30	1	8950RN/A

Juntamente com cabo universal 8953 torna-se no Roquete completo 8950N.

Cardan universal



8966

← L →	€		
120 mm	94,65	1	8966

Roquete reversível de 72 dentes



8950N

← L →		€		
525 mm	72	129,06	1	8950RN

Acessórios para chaves de roquete de 3/4"



8955N/A

← L →		€		
152 mm	24	92,44	1	8955N/A

Adaptador redutor de 3/4" a 1/2"



8965

		€		
3/4"	1/2"	26,68	1	8971

Chave de roquete reversível 3/4". 24 dentes/ Ângulo de ação de 15°.



8955N

← L →		€		
525 mm	24	117,09	1	8955N

Pega universal 3/4"



8955N/B

	← L →	€		
1160 g	390 mm	32,96	5	8955N/B

Adaptador p/roquete reversível de 60 dentes. Diâmetro máx. 60 mm.



8951

	€		
95.5 mm	346,92	1	8951

Diâmetro máx. 60 mm.

Kit de acessórios para roquete 3/4' 8950N, 8950N/A. 7 pcs



8950NA-SO/2

		€		
8	8950N, 8950N/A	99,70	1	8950NA-SO/2

7 pcs

Peças sobresselentes para chaves de roquete de 3/4"



8955N-SPARE

		€		
11	8955N, 8955N/A	49,29	1	8955N-SPARE

1"

Chave de caixa hexagonal em milímetros. Perfil hexagonal, tamanhos métricos.



9500SM

	€		
41 mm	46,68	1	9500SM-41
46 mm	54,44	1	9500SM-46
50 mm	60,22	1	9500SM-50
54 mm	64,18	1	9500SM-54
55 mm	68,55	1	9500SM-55
58 mm	74,92	1	9500SM-58
60 mm	83,73	1	9500SM-60
63 mm	93,85	1	9500SM-63
65 mm	100,08	1	9500SM-65
67 mm	106,59	1	9500SM-67
70 mm	112,44	1	9500SM-70
71 mm	118,34	1	9500SM-71
75 mm	125,85	1	9500SM-75
77 mm	133,85	1	9500SM-77
80 mm	143,32	1	9500SM-80
82 mm	152,81	1	9500SM-82

Perfil hexagonal, tamanhos métricos.

Chaves de caixa de comp. standard, encaixe quadrado de 1". Perfil de acionamento direto de 12 pontos. Em polegadas



9500DZ

	€		
1.5/8 in	34,42	1	9500DZ-1.5/8
1.13/16 in	40,11	1	9500DZ-1.13/16
1.7/8 in	40,11	1	9500DZ-1.7/8
2 in	52,67	1	9500DZ-2
2.1/8 in	52,67	1	9500DZ-2.1/8
2.3/16 in	52,67	1	9500DZ-2.3/16
2.1/4 in	52,67	1	9500DZ-2.1/4
2.3/8 in	60,61	1	9500DZ-2.3/8
2.1/2 in	60,61	1	9500DZ-2.1/2
2.9/16 in	60,61	1	9500DZ-2.9/16
2.5/8 in	70,22	1	9500DZ-2.5/8
2.3/4 in	68,91	1	9500DZ-2.3/4
2.15/16 in	82,35	1	9500DZ-2.15/16
3 in	94,61	1	9500DZ-3
3.1/8 in	94,61	1	9500DZ-3.1/8

Cardan universal 1'



9566A

	€		
167 mm	88,59	1	9566A

Cabo correção em T 1". Consiste em cabeça correção em T 9555AB e cabo universal 9552AB.



9555

	€		
508 mm	100,07	1	9555

Consiste em cabeça correção em T 9555AB e cabo universal 9552AB.

Cabeça correção. Juntamente com cabo universal 9550AB completa o cabo correção em T 9555.



9555AB

	€		
78x78x78 mm	46,75	1	9555AB

Juntamente com cabo universal 9550AB completa o cabo correção em T 9555.

Extensor 1'



9560AB/9563AB

	€		
200 mm	75,71	1	9560AB
440 mm	96,99	1	9563AB



Adaptador para chaves 1" quadrado e chaves de caixa 1"



9565AB

g	€	Icon	Icon
3/4"	50,59	1	9565AB

Chaves de roquete reversíveis de cabeça redonda de 1" com 72 dentes e ângulo de ação de 5°



9550N

L	€	Icon	Icon
640 mm	263,03	1	9550N

Barra de pega intercambiável de chave quadrada 1" para cabeças de chave de roquete



9550N/B

g	€	Icon	Icon
1960 g	53,93	1	9550N/B

Acessórios para chave de roquete de 1"



9550N/A

L	€	Icon	Icon
195 mm	215,72	1	9550N/A

Peça sobresselente para chave de roquete de 1"



9550N-SPARE

X	€	Icon	Icon
2	73,95	1	9550N-SPARE

ESTOJOS VAZIOS PARA CONJUNTOS DE CHAVES DE CAIXA

Caixas vazias para conjunto de chaves



-CASE

g	€	Icon	Icon
110 x 375 x 430 mm	2200 g	62,10	1 S103-CASE
100 x 215 x 370 mm	1120 g	44,82	1 S240AF-CASE
70 x 160 x 280 mm	500 g	31,01	1 S330-CASE
110 x 320 x 375 mm	1620 g	50,57	1 S400-CASE
110 x 320 x 375 mm	1620 g	50,58	1 S410-CASE
100 x 215 x 375 mm	1120 g	44,83	1 S460-CASE
100 x 215 x 375 mm	1120 g	44,50	1 S560-CASE

g	€	Icon	Icon
110 x 375 x 430 mm	2200 g	60,67	1 S81MIX-CASE
110 x 375 x 430 mm	2200 g	60,01	1 S108-CASE
110 x 375 x 430 mm	2200 g	51,47	1 SLX17-CASE
100 x 215 x 375 mm	1120 g	43,44	1 S330L-CASE

Caixas sobresselentes vazias com paredes finas injetadas



4750IB

€	Icon	Icon
35 x 80 x 100 mm	12,95	1 SPAR-CASE-A7
35 x 85 x 160 mm	13,62	1 SPAR-CASE-A6
49 x 152 x 280 mm	19,31	1 SPAR-CASE-A4

CHAVES DE BOCAS PARA ANDAIMES

Chave de andaime



SC2RM

€	Icon	Icon
13-17 mm	37,14	10 SC2RM-13-17
15-17 mm	37,74	10 SC2RM-15-17
19-22 mm	38,93	10 SC2RM-19-22
27-30 mm	70,08	1 SC2RM-27-30



Ferramentas dinamométricas



CHAVES DE BOCAS DINAMOMÉTRICAS DIGITAIS

Chave de binário digital e ângulo fina Bluetooth® com memória e cabeça intercambiável rectangular



TAWMB MICRO

mm	Nm	Nm	€		
9x12 mm	1.5-30 N·m	0.01 N·m	1.706,65	1	TAWMB930M
9x12 mm	6.8-135 N·m	0.1 N·m	1.818,76	1	TAWMB9135M

PRECISÃO: 20% a 100% do máximo da escala

Chave de binário digital e ângulo Bluetooth® com memória e cabeça intercambiável rectangular



TAWMB14_24

mm	Nm	Nm	€		
14x18 mm	17-340 N·m	1 N·m	1.930,88	1	TAWMB14340
24x32 mm	32.5-650 N·m	1 N·m	2.229,85	1	TAWMB24650
24x32 mm	40-800 N·m	1 N·m	2.478,25	1	TAWMB24800

PRECISÃO: 20% a 100% do máximo da escala

Chave dinamométrica eletrônica estreita com medição de binário e ângulo, memória/USB e cabeça de roquete fixa



TAWM MICRO

mm	Nm	Nm	€		
1/4 in	0.6-12 N·m	0.01 N·m	1.052,21	1	TAWM1412M
1/4 in	1.5-30 N·m	0.01 N·m	1.064,97	1	TAWM1430M
3/8 in	6.8-135 N·m	0.1 N·m	1.264,41	1	TAWM38135M

PRECISÃO: 20% a 100% do máximo da escala

Chave dinamométrica eletrônica estreita com medição de binário e ângulo, memória/USB e cabeça intermutável de tipo rectangular



TAWM9 MICRO

mm	Nm	Nm	€		
9x12 mm	0.6-12 N·m	0.01 N·m	1.027,38	1	TAWM912M
9x12 mm	1.5-30 N·m	0.01 N·m	1.084,84	1	TAWM930M
9x12 mm	6.8-135 N·m	0.1 N·m	1.239,50	1	TAWM9135M

PRECISÃO: 20% a 100% do máximo da escala

Chave dinamométrica eletrônica com medição de binário e ângulo, memória/USB e cabeça de roquete fixa, com memória e transferência de dados por USB



TAWM

mm	Nm	Nm	€		
3/8 in	7-135 N·m	1 N·m	1.222,08	1	TAWM38135
1/2 in	17-340 N·m	1 N·m	1.201,68	1	TAWM12340
3/4 in	40-800 N·m	1 N·m	1.729,07	1	TAWM34800

PRECISÃO: 20% a 100% do máximo da escala

Chave dinamométrica eletrônica com medição de binário e ângulo, memória/USB e cabeça intermutável de tipo rectangular, com memória e transferência de dados por USB



TAWM9_14_24

mm	Nm	Nm	€		
9x12 mm	7-135 N·m	1 N·m	1.177,76	1	TAWM9135
14x18 mm	17-340 N·m	1 N·m	1.265,46	1	TAWM14340
24x32 mm	40-800 N·m	1 N·m	1.866,87	1	TAWM24800

PRECISÃO: 20% a 100% do máximo da escala

Chave dinamométrica eletrônica estreita com medição de binário e ângulo e cabeça de roquete fixa



TAW MICRO

	Nm	Nm	€		
1/4 in	0.6-12 N·m	0.01 N·m	916,15	1	TAW1412M
1/4 in	1.5-30 N·m	0.01 N·m	916,15	1	TAW1430M
3/8 in	6.8-135 N·m	0.1 N·m	909,38	1	TAW38135M

PRECISÃO: 20% a 100% do máximo da escala

Chave dinamométrica eletrônica estreita com medição de binário e ângulo e cabeça intermutável de tipo retangular



TAW9 MICRO

mm	Nm	Nm	€		
9x12 mm	0.6-12 N·m	0.01 N·m	809,72	1	TAW912M
9x12 mm	1.5-30 N·m	0.01 N·m	830,65	1	TAW930M
9x12 mm	6.8-135 N·m	0.1 N·m	884,46	1	TAW9135M

PRECISÃO: 20% a 100% do máximo da escala

Chave dinamométrica eletrônica com medição de binário e ângulo e cabeça de roquete fixa



TAW

	Nm	Nm	€		
3/8 in	7-135 N·m	1 N·m	707,66	1	TAW38135
1/2 in	17-340 N·m	1 N·m	774,42	1	TAW12340
3/4 in	40-800 N·m	1 N·m	1.375,26	1	TAW34800

PRECISÃO: 20% a 100% do máximo da escala

Chave dinamométrica eletrônica com medição de binário e ângulo e cabeça intermutável de tipo retangular



TAW9 14 24

	Nm	Nm	€		
9x12 mm	7-135 N·m	1 N·m	939,70	1	TAW9135
14x18 mm	17-340 N·m	1 N·m	1.039,93	1	TAW14340
24x32 mm	40-800 N·m	1 N·m	1.233,30	1	TAW24800

PRECISÃO: 20% a 100% do máximo da escala

Chave de parafusos dinamométrica eletrônica com cabeça intermutável de tipo retangular. com cabeças substituíveis



IZO-D

	Nm	Nm	€		
1/4 in	3-30 N·m	0.1 N·m	745,95	1	IZO-D-30
3/8 in	13.5-135 N·m	1 N·m	745,95	1	IZO-D-135
1/2 in	20-200 N·m	1 N·m	817,83	1	IZO-D-200
1/2 in	34-340 N·m	1 N·m	942,40	1	IZO-D-340

com cabeças substituíveis

Chave dinamométrica eletrônica com cabeça de roquete fixa. Com cabeça fixa



IZO-DR

	Nm	Nm	€		
3/4 in	81-810 N·m	1 N·m	2.239,72	1	IZO-DR-810

Com cabeça fixa



CHAVES DINAMOMÉTRICAS MECÂNICAS

Chave dinamométrica de roquete mecânica ajustável com escala em janela e cabeça de roquete fixa

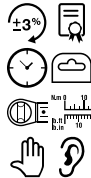

74WR-15/74WR-25

mm	Nm	Nm	€		
1/4 in	3-15 N·m	0.1 N·m	256,52	1	74WR-15
1/4 in	5-25 N·m	0.2 N·m	256,52	1	74WR-25

Chave dinamométrica de roquete mecânica ajustável com escala em janela e cabeça de roquete fixa de inversão



74WR-50/74WR-400

mm	Nm	Nm	€		
3/8"	10-50 N·m	0.5 N·m	239,42	1	74WR-50
3/8"	20-100 N·m	1 N·m	244,06	1	74WR-100B
1/2"	20-100 N·m	1 N·m	244,06	1	74WR-100
1/2"	40-200 N·m	2 N·m	244,06	1	74WR-200
1/2"	60-300 N·m	2 N·m	256,52	1	74WR-300
1/2"	60-340 N·m	5 N·m	280,95	1	74WR-340
3/4"	80-400 N·m	5 N·m	339,59	1	74WR-400

Chave dinamométrica de roquete mecânica ajustável, com escala em janela e cabeça intermutável de tipo retangular



74W9/74W14

mm	Nm	Nm	€		
9x12 mm	3-15 N·m	0.2 N·m	244,31	1	74W9-15
9x12 mm	5-25 N·m	0.2 N·m	243,09	1	74W9-25
9x12 mm	10-50 N·m	0.5 N·m	230,87	1	74W9-50

mm	Nm	Nm	€		
9x12 mm	20-100 N·m	1 N·m	230,87	1	74W9-100
9x12 mm	40-200 N·m	1 N·m	293,17	1	74W9-200
14x18 mm	40-200 N·m	2 N·m	293,17	1	74W14-200
14x18 mm	60-300 N·m	2 N·m	329,81	1	74W14-300
14x18 mm	80-400 N·m	5 N·m	390,89	1	74W14-400

Chave dinamométrica de roquete mecânica ajustável, com escala em janela e cabeça intermutável de tipo espigão

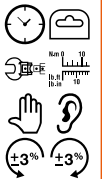

74WS-15/74WS-300

mm	Nm	Nm	€		
16 mm	3-15 N·m	0.2 N·m	244,31	1	74WS-15
16 mm	5-25 N·m	0.2 N·m	243,09	1	74WS-25
16 mm	10-50 N·m	0.5 N·m	230,87	1	74WS-50
16 mm	20-100 N·m	1 N·m	230,87	1	74WS-100
16 mm	40-200 N·m	2 N·m	293,17	1	74WS-200
16 mm	60-300 N·m	2 N·m	329,81	1	74WS-300

Chave dinamométrica de roquete mecânica ajustável, com escala marcada e cabeça de roquete fixa

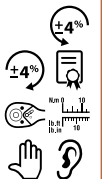

7455

mm	Nm	Nm	€		
1/4 in	1-5 N·m	0.05 N·m	251,88	1	7455-5
1/4 in	3-15 N·m	0.1 N·m	251,88	1	7455-15
1/4 in	4-20 N·m	0.1 N·m	251,88	1	7455-20
1/4 in	5-25 N·m	0.1 N·m	251,88	1	7455-25
3/8 in	12-60 N·m	0.5 N·m	251,89	1	7455-60
3/8 in	20-100 N·m	0.5 N·m	251,89	1	7455-100
1/2 in	20-100 N·m	0.5 N·m	238,05	1	7455-100A
1/2 in	40-200 N·m	2 N·m	277,07	1	7455-200
1/2 in	60-300 N·m	2 N·m	311,00	1	7455-300
1/2 in	68-340 N·m	2 N·m	311,00	1	7455-340
3/4 in	100-500 N·m	5 N·m	629,71	1	7455-500
3/4 in	160-800 N·m	5 N·m	818,64	1	7455-800
1 in	200-1000 N·m	10 N·m	1.090,07	1	7455-1000

Chave dinamométrica de roquete mecânica ajustável com escala marcada, cabeça de roquete fixa e cabo com duas secções

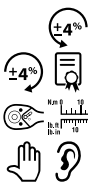

7455-1500

			€		
1 in	300-1500 N·m	10 N·m	1.390,00	1	7455-1500

Chave dinamométrica de roquete mecânica ajustável com escala marcada, cabeça intermutável e cabo com duas secções

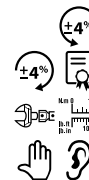

7465-1500

			€		
27x36 mm	300-1500 N·m	10 N·m	1.741,58	1	7465-1500

Chave dinamométrica de roquete mecânica ajustável com escala marcada e cabeça fixa com encaixe quadrado

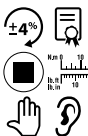

7455-2500

			€		
1 in	500-2500 N·m	10 N·m	5.642,17	1	7455-2500

Chave dinamométrica de roquete mecânica ajustável com escala marcada e cabeça de roquete flexível



7456

			€		
3/8 in	10-80 lbf·ft	0.5 lbf·ft	314,87	1	7456-80LB

Chave dinamométrica de roquete mecânica ajustável com escala marcada e cabeça intermutável



7465

			€		
9x12 mm	1-5 N·m	0.05 N·m	220,51	1	7465-5
9x12 mm	3-15 N·m	0.1 N·m	225,53	1	7465-15
9x12 mm	6-30 N·m	0.1 N·m	231,80	1	7465-30
9x12 mm	12-60 N·m	0.5 N·m	238,05	1	7465-60
9x12 mm	20-100 N·m	0.5 N·m	238,05	1	7465-100
14x18 mm	40-200 N·m	2 N·m	269,38	1	7465-200
14x18 mm	68-340 N·m	2 N·m	294,44	1	7465-340
24x32 mm	160-800 N·m	5 N·m	751,76	1	7465-800

Chave dinamométrica de roquete mecânica ajustável de posição livre da mão e cabeça de roquete fixa



75R3/75R1

			€		
3/4" in	130-650 N·m	5 N·m	1.087,17	1	75R3-650
3/4" in	200-800 N·m	10 N·m	1.215,43	1	75R3-800
3/4" in	300-1000 N·m	10 N·m	1.453,62	1	75R3-1000
1" in	500-1500 N·m	10 N·m	1.360,00	1	75R1-1500



Chave dinamométrica de roquete mecânica ajustável, posição livre da mão e cabeça intermutável de tipo espigão



75S-650

			€		
22 mm	130-650 N·m	5 N·m	1.074,96	1	75S-650

Chave mecânica de torque de rutura ajustável com cabeça de roquete fixa e barra de ajuste dupla



76R1-2000

			€		
1 in	900-2000 N·m	50 N·m	2.050,00	1	76R1-2000

Chave dinamométrica de roquete mecânica ajustável com escala em janela, sistema de flexão e cabeça de roquete fixa

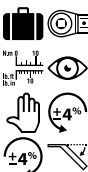

76R3

			€		
3/4-1 in	120-600 N·m	10 N·m	671,85	1	76R3-600
3/4-1 in	200-800 N·m	10 N·m	696,28	1	76R3-800
3/4-1 in	300-1000 N·m	20 N·m	726,81	1	76R3-1000

Chave de roquete mecânica dinamométrica ajustável com escala em janela, mecanismo de flexão e cabeça intermutável de tipo espigão

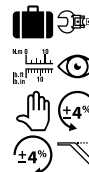

76S-600

			€		
22 mm	120-600 N·m	10 N·m	684,06	1	76S-600

Chave mecânica de torque de rutura ajustável com cabeça de roquete fixa



76R3-1500

			€		
3/4 in	700-1500 N·m	25 N·m	1.535,32	1	76R3-1500

Chave de Torque mecânica com escala, cabeça fixa de acionamento quadrado e pega metálica

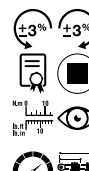

7454 M

			€		
1/4 in	0.7-3.5 N·m	0.1 N·m	326,51	1	7454-3.5
1/4 in	1.68-8.4 N·m	0.2 N·m	326,51	1	7454-8.4
3/8 in	3.4-17 N·m	0.5 N·m	326,51	1	7454-17
3/8 in	6.4-32 N·m	0.5 N·m	244,30	1	7454-32
3/8 in	14-70 N·m	1 N·m	347,11	1	7454-70A
1/2 in	28-140 N·m	5 N·m	465,56	1	7454-140A
1/2 in	46-230 N·m	10 N·m	473,80	1	7454-230
	160-800 N·m	20 N·m	834,30	1	7454-800A

Chave dinamométrica mecânica com escala circular, cabeça de encaixe quadrado fixa e cabo metálico

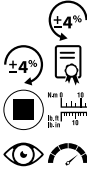

7454-480/7454-800

			€		
3/4 in	100-480 N·m	10 N·m	1.027,67	1	7454-480

Chave dinamométrica mecânica com escala circular/LED, cabeça fixa com encaixe quadrado e cabo com duas secções



7454-1400E

			€		
1 in	275-1400 N·m	25 N·m	3.814,89	1	7454-1400E

Chave dinamométrica mecânica com escala circular, cabeça fixa com encaixe quadrado e cabo com duas secções

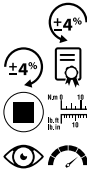

7454-1400

			€		
1 in	275-1400 N·m	25 N·m	2.340,84	1	7454-1400

Chave dinamométrica de roquete mecânica com pré-regulação e cabeça de roquete fixa



74PR-20

			€		
1/4 in	4-20 N·m	219 mm	195,45	1	74PR-20

Chave dinamométrica mecânica com escala circular/LED e cabeça fixa com encaixe quadrado



7454-800E

			€		
3/4 in	160-800 N·m	20 N·m	1.712,80	1	7454-800E

Chave dinamométrica de roquete mecânica com pré-regulação e cabeça de roquete fixa de inversão



74PR-60/74PR-400

			€		
3/8 in	12-60 N·m	295 mm	205,21	1	74PR-60
1/2 in	12-60 N·m	301 mm	205,21	1	74PR-60A
3/8 in	20-100 N·m	335 mm	210,10	1	74PR-100
1/2 in	20-100 N·m	342 mm	210,10	1	74PR-100A
1/2 in	40-200 N·m	425 mm	213,77	1	74PR-200
1/2 in	60-300 N·m	668 mm	256,52	1	74PR-300
3/4 in	80-400 N·m	675 mm	299,27	1	74PR-400



Chave dinamométrica de roquete mecânica com pré-regulação, cabeça intermutável de tipo retangular e cabo de plástico



74P9-20

mm	Nm	L	€		
9x12 mm	4-20 N·m	205 mm	195,45	1	74P9-20

Chave dinamométrica de roquete mecânica com pré-regulação, cabeça intermutável de tipo espigão e cabo de borracha



74PS-60/74PS-300

mm	Nm	L	€		
16 mm	12-60 N·m	283 mm	195,45	1	74PS-60
16 mm	20-100 N·m	324 mm	189,34	1	74PS-100
16 mm	40-200 N·m	405 mm	189,34	1	74PS-200
16 mm	60-300 N·m	643 mm	293,17	1	74PS-300

Chave dinamométrica de roquete mecânica com pré-regulação, cabeça intermutável de tipo retangular e cabo de borracha



74P9-60/74P14-400

mm	Nm	L	€		
9x12 mm	12-60 N·m	286 mm	195,45	1	74P9-60
9x12 mm	20-100 N·m	326 mm	189,34	1	74P9-100
14x18 mm	40-200 N·m	403 mm	189,34	1	74P14-200
14x18 mm	60-300 N·m	534 mm	293,17	1	74P14-300
14x18 mm	80-400 N·m	652 mm	305,38	1	74P14-400

Chave dinamométrica de roquete mecânica com pré-regulação, posição livre da mão e cabeça de roquete fixa



75P3/75P1

mm	Nm	L	€		
3/4 in	130-650 N·m	848 mm	1.087,17	1	75P3-650
3/4" in	200-800 N·m	1030 mm	1.191,00	1	75P3-800
3/4" in	300-1000 N·m	1238 mm	1.453,62	1	75P3-1000
1" in	500-1500 N·m	1563 mm	1.575,78	1	75P1-1500

Chave dinamométrica de roquete mecânica com pré-regulação, cabeça intermutável de tipo espigão e cabo de plástico



74PS-20

mm	Nm	L	€		
16 mm	4-20 N·m	206 mm	195,45	1	74PS-20

Chave dinamométrica de roquete mecânica com pré-regulação, posição livre da mão e cabeça intermutável de tipo espigão



75PS-650

mm	Nm	L	€		
22 mm	130-650 N·m	800 mm	1.062,74	1	75PS-650

Extensor do cabo para chaves de roquete dinâmométricas da série 75



75EXT

			€		
700 mm	60 mm	1.600 kg	238,20	1	75EXT

CHAVES DE PARAFUSOS DINAMOMETRICAS

Chave de parafusos de torque e ângulo digital Bluetooth®



TASMB14H

			€		
1/4 in	0.04-0.7 N·m	0.01 N·m	1.606,98	1	TASMB14H007
1/4 in	0.45-9 N·m	0.01 N·m	1.644,36	1	TASMB14H09

PRECISÃO: 20% a 100% do máximo da escala

Chave digital de torque e ângulo com memória e USB



TASM14H

		€		
1/4 in	0.035-0.700 N·m	1.091,80	1	TASM14H007
1/4 in	0.45-9 N·m	1.122,70	1	TASM14H09

Chave de parafusos eletrônica com medição de binário e ângulo



TAS14

			€		
1/4" in		0.04-0.7 N·m	707,85	1	TAS14H007
- in	1/4" in	0.04-0.7 N·m	707,85	1	TAS14S007
1/4" in		0.45-9 N·m	726,81	1	TAS14H09
	1/4" in	0.45-9 N·m	726,81	1	TAS14S09

PRECISÃO: 20% a 100% do máximo da escala

Chave de parafusos dinâmométrica ajustável com escala em janela. Com escala, ajustável



6973N-6978N

			€		
1/4 in	16-80 cNm	1 cNm	297,00	1	6973N
1/4 in	40-200 cNm	2 cNm	303,90	1	6976N
1/4 in	90-450 cNm	5 cNm	310,61	1	6978N

Com escala, ajustável

Minichave dinâmométrica ajustável com ponta aparafusadora fixa



6852-5

			€		
1/4 in	1-5 N·m	0.1 N·m	271,19	1	6852-5



Conjunto de minichaves dinâmicas ajustáveis com ponta aparafusadora fixa



6852-5/S17

		€		
32 x 70 x 200 mm	0.29 kg	297,67	1	6852-5/S17

KM653-QR-1P	
6852-5	
6700SM-4	
59S/PH0, 59S/PH1	
59S/PZ0, 59S/PZ1	
59S/H1.5	
59S/0.8-5.5, 59S/0.6-4.5	
59S/T6, 59S/T7, 59S/T8	

Chave de parafusos dinâmica ajustável com escala marcada em cN.m



TSS120

		€		
1/4 in	10-120 cNM	219,12	1	TSS120

Chave de parafusos dinâmica ajustável com escala marcada em N.m



TSS600

		€		
1/4 in	1-6 N-m	219,12	1	TSS600

Chave de fendas dinâmica predefinida com suporte para pontas sextavado de 1/4"



6873N-6880N

			€		
7-70 cNM	1/4 in	1/4 in	273,57	1	6876N
15-170 cNM	1/4 in	1/4 in	280,40	1	6878N
45-450 cNM	1/4 in	1/4 in	310,60	1	6880N

Minichave dinâmica com pré-regulação e ponta aparafusadora fixa

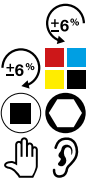

6852P-5

			€		
1/4" in	1-5 N-m	157 mm	305,38	1	6852P-5

Chave de parafusos dinâmica ERGO™ com pré-regulação fixa. Com hastes aparafusadoras TORX® e TORX Plus®



BE-6990

			€		
0.6 N-m	T6	IP6	59,83	1	BE-6990-IP6
0.9 N-m	T7	IP7	59,83	1	BE-6990-IP7
1.2 N-m	T8	IP8	59,83	1	BE-6990-IP8
1.4 N-m	T9	IP9	59,83	1	BE-6990-IP9
2 N-m	T10	IP10	59,83	1	BE-6990-IP10
3 N-m	T15	IP15	59,83	1	BE-6990-IP15

Para parafusos TORX PLUS

Conjunto de chaves de parafusos dinâmicas ERGO™ com pré-regulação fixa. Para parafusos TORX PLUS



ergo



BE-6990-IPSET

Dimensões	Peso	Preço	Quantidade	Referência
40 x 170 x 215 mm	0.755 kg	€ 206,04	1	BE-6990-IPSET

Para parafusos TORX PLUS

BE-6990-IP7, BE-6990-IP8, BE-6990-IP9, BE-6990-IP15

Hastes aparafusadoras com ponta TORX®



BE-6990TX-KL

Tamanho	Diâmetro	Comprimento	Preço	Quantidade	Referência
T6	1.70 mm	160 mm	7,46	10	BE-6990TX-T6-KL
T7	1.99 mm	160 mm	7,46	10	BE-6990TX-T7-KL
T8	2.31 mm	160 mm	7,46	10	BE-6990TX-T8-KL
T9	2.50 mm	170 mm	7,46	10	BE-6990TX-T9-KL
T10	2.74 mm	170 mm	7,46	10	BE-6990TX-T10KL
T15	3.27 mm	170 mm	7,46	10	BE-6990TX-T15KL

Hastes aparafusadoras dinâmicas com ponta TORX PLUS®



BE-6990-IP-KL

Tamanho	Diâmetro	Comprimento	Preço	Quantidade	Referência
IP6	1.50 mm	170 mm	7,51	10	BE-6990-IP6-KL
IP7	1.99 mm	170 mm	7,51	10	BE-6990-IP7-KL
IP8	2.31 mm	170 mm	7,51	10	BE-6990-IP8-KL
IP9	2.50 mm	170 mm	7,51	10	BE-6990-IP9-KL
IP10	2.74 mm	170 mm	7,51	10	BE-6990-IP10-KL
IP15	3.27 mm	170 mm	7,51	10	BE-6990-IP15-KL

Haste aparafusadora de substituição para parafusos de cabeça TORX®



BE-6990-IP20-KL

Tipo	Diâmetro	Comprimento	Preço	Quantidade	Referência
IP20	4.5 mm	90 mm	€ 6,05	10	BE-6990-IP20-KL

Haste aparafusadora de substituição para parafusos de cabeça TORX®



BE-6990TX-T20KL

Tipo	Diâmetro	Comprimento	Preço	Quantidade	Referência
T20	4.5 mm	92 mm	7,46	10	BE-6990TX-T20KL

MULTIPLICADORES

Multiplicador de binário manual com braços de reação angular e reto



89049TM-1000

Capacidade	Diâmetro	Comprimento	Preço	Quantidade	Referência
1000 Nm - 3/4 in	4.8:1/4.9:1*	208/204 Nm - 1/2 in	€ 1.575,78	1	89049TM-1000



Multiplicador de binário manual com braços de reação angular e reto



8905-TM/9505-TM

in	Ratio	in	€	Icons
1300 Nm - 3/4 in	5:1	260 Nm - 1/2 in	1.493,67	1 8905-TM
2700 Nm - 1 in	5:1	540 Nm - 3/4 in	1.493,67	1 9505-TM

Multiplicador de torque manual com placa de reação



9505

in	Ratio	in	€	Icons
3400 Nm - 1 in	5:1	680 Nm - 3/4 in	3.890,67	1 9505-3400

Multiplicador de torque manual com placa de reação e sistema de bloqueio de roquete



9525-9625

in	Ratio	in	€	Icons
3400 Nm - 1 in	25:1	136 Nm - 1/2 in	7.208,79	1 9525-3400
9500 Nm - 1.1/2 in	25:1	380 Nm - 3/4 in	6.437,50	1 9625-9500

Multiplicador de binário manual com braço de reação reto



95155B/9526B

in	Ratio	in	€	Icons
3000 Nm - 1 in	15.5:1	193 Nm - 1/2 in	4.336,45	1 95155B-3000
4500 Nm - 1 in	26:1	173 Nm - 1/2 in	4.519,69	1 9526B-4500

Multiplicador de binário manual compacto com braço de reação angular



89222CR/96255CR

in	Ratio	in	€	Icons
1000 Nm - 3/4 in	22.2:1	45 Nm - 1/2 in	3.053,84	1 89222CR-1000
2000 Nm - 1 in	27:1	74 Nm - 1/2 in	3.359,23	1 9527CR-2000
4000 Nm - 1 in	25:1	160 Nm - 1/2 in	4.873,93	1 9525CR-4000
7000 Nm - 1.1/2 in	25.5:1	274 Nm - 1/2 in	6.101,57	1 96255CR-7000

FERRAMENTAS DE TESTE DE BINÁRIO

Provadores multifuncionais



TEA003-TEA030

Nm	in	Nm	€	Icons
0.1-3.0 N·m	1/4 in	0.01 N·m	1.568,46	1 TEA003
0.5-10 N·m	1/4 in	0.01 N·m	1.568,46	1 TEA010
1.5-30 N·m	10 mm	0.1 N·m	1.493,77	1 TEA030
1.5-30 N·m	10 mm	0.1 N·m	1.493,50	1 TEA030A



Equipamentos de teste de torque



TJS

max	in	mm	€	Icons
3 N·m	1/4 in	31 mm	289,43	1 TJS003
10 N·m	1/4 in	31 mm	295,61	1 TJS010
30 N·m	1/4 in	31 mm	313,12	1 TJS030

Provadores multifuncionais



TEA065-TEA2100

mm		in		€		
3-65 N·m	- mm	3/8 in		1.476,96	1	TEA065
10-350 N·m	- mm	1/2 in		1.459,73	1	TEA350
50-1100 N·m	27 mm	3/4 in		1.960,56	1	TEA1100
200-2100 N·m	27 mm			2.444,17	1	TEA2100

ADAPTADORES DE BINÁRIO E ÂNGULO

Medidor eletrônico de binário e ângulo



TAM

mm		€		
1/4 in	1,5-30 N·m	362,33	1	TAM1430
3/8 in	6,8-135 N·m	362,33	1	TAM38135
1/2 in	6,8-135 N·m	404,05	1	TAM12135
1/2 in	10-200 N·m	404,05	1	TAM12200
1/2 in	17-340 N·m	494,63	1	TAM12340

Goniômetro eletrônico



MAM

mm		€		
0-360°	56 mm	248,76	1	MAM50M

Goniômetro com íman



7851-M/8951-M

mm		€		
1/2 in	0-360	154,49	1	7851-M
3/4 in	0-360	237,90	1	8951-M

Goniômetro com grampo



7851-G

mm		€		
1/2 in	0-360	172,89	1	7851-G

FERRAMENTAS DE ELEMENTOS DE INSERÇÃO

Cabeça de roquete de tipo redondo com conector retangular



9/14/24/27R





mm		máx	€		
1/4 in	9x12 mm	30 N·m	62,64	1	9R-1/4
3/8 in	9x12 mm	135 N·m	65,16	1	9R-3/8
1/2 in	9x12 mm	160 N·m	66,41	1	9R-1/2
1/2 in	14x18 mm	340 N·m	70,17	1	14R-1/2
3/4 in	14x18 mm	420 N·m	112,76	1	14R-3/4
3/4 in	24x32 mm	1000 N·m	181,68	1	24R-3/4
1 in	24x32 mm	1200 N·m	300,70	1	24R-1
1 in	27x36 mm	2500 N·m	344,56	1	27R-1



Cabeça de roquete de inversão de tipo quadrado com conector retangular







9/14/24/27T

				€		
1/4 in	9x12 mm	30 N·m	70,17	1	9T-1/4	
3/8 in	9x12 mm	135 N·m	75,18	1	9T-3/8	
1/2 in	9x12 mm	160 N·m	80,18	1	9T-1/2	
1/2 in	14x18 mm	340 N·m	90,21	1	14T-1/2	
3/4 in	14x18 mm	420 N·m	162,88	1	14T-3/4	
3/4 in	24x32 mm	1000 N·m	275,64	1	24T-3/4	
1 in	24x32 mm	1200 N·m	363,36	1	24T-1	
1 in	27x36 mm	2500 N·m	400,94	1	27T-1	

Cabeça fixa com encaixe quadrado e conector retangular







9/14/24/27F

				€		
1/4 in	9x12 mm	30 N·m	38,85	1	9F-1/4	
3/8 in	9x12 mm	135 N·m	38,85	1	9F-3/8	
1/2 in	9x12 mm	160 N·m	40,09	1	9F-1/2	
1/2 in	14x18 mm	340 N·m	42,60	1	14F-1/2	
3/4 in	14x18 mm	420 N·m	71,42	1	14F-3/4	
3/4 in	24x32 mm	1000 N·m	230,54	1	24F-3/4	
1 in	24x32 mm	1200 N·m	269,38	1	24F-1	
1 in	27x36 mm	2500 N·m	319,51	1	27F-1	

Cabeça de roquete de tipo pera com conector retangular



9/14P





				€		
1/4 in	9x12 mm	30 N·m	83,96	1	9P-1/4	
3/8 in	9x12 mm	135 N·m	86,46	1	9P-3/8	

				€		
1/2 in	9x12 mm	160 N·m	88,96	1	9P-1/2	
1/2 in	14x18 mm	340 N·m	100,24	1	14P-1/2	

Cabeça de roquete de tipo pera com desengate rápido e conector retangular







9/14Q

				€		
1/4 in	9x12 mm	30 N·m	97,72	1	9Q-1/4	
3/8 in	9x12 mm	135 N·m	100,24	1	9Q-3/8	
1/2 in	9x12 mm	160 N·m	102,74	1	9Q-1/2	
1/2 in	14x18 mm	340 N·m	110,26	1	14Q-1/2	

Cabeça de roquete para hastas aparafusadoras com conector retangular







9B





			€		
1/4 in	9x12 mm	60,13	1	9B-1/4	
5/16 in	9x12 mm	81,44	1	9B-5/16	

Chave de boca (sistema métrico) com conector retangular



9/14/24/277





			€		
mm	mm	N·m			
7 mm	9x12 mm	9 N·m	27,56	1	97-7
8 mm	9x12 mm	13 N·m	27,56	1	97-8
9 mm	9x12 mm	18 N·m	27,56	1	97-9
10 mm	9x12 mm	24 N·m	27,56	1	97-10
11 mm	9x12 mm	32 N·m	27,56	1	97-11
12 mm	9x12 mm	41 N·m	27,56	1	97-12
13 mm	9x12 mm	51 N·m	27,56	1	97-13
14 mm	9x12 mm	63 N·m	27,55	1	97-14
15 mm	9x12 mm	77 N·m	27,55	1	97-15
16 mm	9x12 mm	92 N·m	27,56	1	97-16
17 mm	9x12 mm	109 N·m	27,56	1	97-17
18 mm	9x12 mm	125 N·m	27,56	1	97-18
19 mm	9x12 mm	145 N·m	27,56	1	97-19
21 mm	9x12 mm	160 N·m	46,20	1	97-21
22 mm	9x12 mm	160 N·m	53,22	1	97-22
24 mm	9x12 mm	160 N·m	53,22	1	97-24
27 mm	9x12 mm	160 N·m	48,76	1	97-27
30 mm	9x12 mm	160 N·m	47,62	1	97-30
32 mm	9x12 mm	160 N·m	47,62	1	97-32
13 mm	14x18 mm	51 N·m	31,33	1	147-13
14 mm	14x18 mm	63 N·m	31,33	1	147-14
15 mm	14x18 mm	77 N·m	31,33	1	147-15
16 mm	14x18 mm	92 N·m	31,33	1	147-16
17 mm	14x18 mm	109 N·m	31,33	1	147-17
18 mm	14x18 mm	125 N·m	31,33	1	147-18
19 mm	14x18 mm	145 N·m	31,33	1	147-19
21 mm	14x18 mm	190 N·m	37,58	1	147-21
22 mm	14x18 mm	220 N·m	37,58	1	147-22
24 mm	14x18 mm	280 N·m	37,58	1	147-24
25 mm	14x18 mm	320 N·m	42,60	1	147-25
27 mm	14x18 mm	360 N·m	42,60	1	147-27
30 mm	14x18 mm	360 N·m	42,60	1	147-30
32 mm	14x18 mm	360 N·m	42,60	1	147-32
33 mm	14x18 mm	360 N·m	46,37	1	147-33
34 mm	14x18 mm	360 N·m	46,37	1	147-34
35 mm	14x18 mm	360 N·m	46,37	1	147-35
36 mm	14x18 mm	360 N·m	46,37	1	147-36
37 mm	14x18 mm	360 N·m	48,87	1	147-37
38 mm	14x18 mm	360 N·m	48,87	1	147-38
39 mm	14x18 mm	360 N·m	48,87	1	147-39
41 mm	14x18 mm	360 N·m	48,87	1	147-41
45 mm	14x18 mm	360 N·m	172,91	1	147-45
46 mm	14x18 mm	360 N·m	172,91	1	147-46
50 mm	14x18 mm	360 N·m	179,17	1	147-50
55 mm	14x18 mm	360 N·m	192,95	1	147-55
60 mm	14x18 mm	360 N·m	206,73	1	147-60
65 mm	14x18 mm	360 N·m	211,15	1	147-65
68 mm	14x18 mm	360 N·m	233,04	1	147-68
70 mm	14x18 mm	360 N·m	233,04	1	147-70
75 mm	14x18 mm	360 N·m	273,13	1	147-75
90 mm	14x18 mm	360 N·m	345,81	1	147-90
24 mm	24x32 mm	1200 N·m	191,71	1	247-24
27 mm	24x32 mm	1200 N·m	191,71	1	247-27

			€		
mm	mm	N·m			
30 mm	24x32 mm	1200 N·m	194,22	1	247-30
32 mm	24x32 mm	1200 N·m	194,22	1	247-32
34 mm	24x32 mm	1200 N·m	194,22	1	247-34
36 mm	24x32 mm	1200 N·m	199,22	1	247-36
41 mm	24x32 mm	1200 N·m	199,22	1	247-41
46 mm	24x32 mm	1200 N·m	202,97	1	247-46
50 mm	24x32 mm	1200 N·m	207,98	1	247-50
55 mm	24x32 mm	1200 N·m	214,26	1	247-55
60 mm	24x32 mm	1200 N·m	218,01	1	247-60
30 mm	27x36 mm	3000 N·m	214,26	1	277-30
32 mm	27x36 mm	3000 N·m	214,26	1	277-32
34 mm	27x36 mm	3000 N·m	214,26	1	277-34
36 mm	27x36 mm	3000 N·m	219,26	1	277-36
41 mm	27x36 mm	3000 N·m	240,56	1	277-41
46 mm	27x36 mm	3000 N·m	245,57	1	277-46
50 mm	27x36 mm	3000 N·m	251,85	1	277-50
55 mm	27x36 mm	3000 N·m	259,35	1	277-55
60 mm	27x36 mm	3000 N·m	264,37	1	277-60

Chave de boca (sistema imperial) com conector retangular



9/14/24/277"





			€		
in	mm	N·m			
1/4 in	9x12 mm	6 N·m	28,83	1	97-1/4
5/16 in	9x12 mm	13 N·m	28,83	1	97-5/16
3/8 in	9x12 mm	24 N·m	28,83	1	97-3/8
7/16 in	9x12 mm	32 N·m	28,83	1	97-7/16
1/2 in	9x12 mm	51 N·m	28,83	1	97-1/2
17/32 in	9x12 mm	63 N·m	28,83	1	97-17/32
9/16 in	9x12 mm	77 N·m	28,83	1	97-9/16
5/8 in	9x12 mm	92 N·m	28,83	1	97-5/8
11/16 in	9x12 mm	125 N·m	28,83	1	97-11/16
3/4 in	9x12 mm	145 N·m	28,83	1	97-3/4
13/16 in	9x12 mm	160 N·m	45,11	1	97-13/16
7/8 in	9x12 mm	160 N·m	45,11	1	97-7/8
15/16 in	9x12 mm	160 N·m	47,62	1	97-15/16
1 in	9x12 mm	160 N·m	47,62	1	97-1
7/16 in	14x18 mm	32 N·m	35,08	1	147-7/16
1/2 in	14x18 mm	51 N·m	35,08	1	147-1/2
9/16 in	14x18 mm	77 N·m	35,08	1	147-9/16
5/8 in	14x18 mm	92 N·m	35,08	1	147-5/8
11/16 in	14x18 mm	109 N·m	35,08	1	147-11/16
3/4 in	14x18 mm	145 N·m	35,08	1	147-3/4
13/16 in	14x18 mm	190 N·m	40,09	1	147-13/16
7/8 in	14x18 mm	220 N·m	40,09	1	147-7/8
15/16 in	14x18 mm	280 N·m	40,09	1	147-15/16
1 in	14x18 mm	360 N·m	40,09	1	147-1
1 1/8 in	14x18 mm	360 N·m	40,09	1	147-1.1/8
1 1/4 in	14x18 mm	360 N·m	42,60	1	147-1.1/4







Chave de luneta (sistema métrico) com conector retangular



9/14/24/278

			€		
7 mm	9x12 mm	25 N·m	30,08	1	98-7
8 mm	9x12 mm	34 N·m	30,08	1	98-8
9 mm	9x12 mm	45 N·m	30,08	1	98-9
10 mm	9x12 mm	58 N·m	30,08	1	98-10
11 mm	9x12 mm	47 N·m	30,08	1	98-11
12 mm	9x12 mm	89 N·m	30,08	1	98-12
13 mm	9x12 mm	105 N·m	30,08	1	98-13
14 mm	9x12 mm	125 N·m	30,08	1	98-14
15 mm	9x12 mm	145 N·m	30,08	1	98-15
16 mm	9x12 mm	160 N·m	30,08	1	98-16
17 mm	9x12 mm	160 N·m	30,08	1	98-17
18 mm	9x12 mm	160 N·m	30,08	1	98-18
19 mm	9x12 mm	160 N·m	30,08	1	98-19
21 mm	9x12 mm	160 N·m	30,08	1	98-21
22 mm	9x12 mm	160 N·m	30,08	1	98-22
13 mm	14x18 mm	105 N·m	32,57	1	148-13
14 mm	14x18 mm	125 N·m	32,57	1	148-14
15 mm	14x18 mm	150 N·m	32,57	1	148-15
16 mm	14x18 mm	175 N·m	32,57	1	148-16
17 mm	14x18 mm	200 N·m	32,57	1	148-17
18 mm	14x18 mm	230 N·m	32,57	1	148-18
19 mm	14x18 mm	260 N·m	32,57	1	148-19
21 mm	14x18 mm	330 N·m	37,58	1	148-21
22 mm	14x18 mm	360 N·m	37,58	1	148-22
24 mm	14x18 mm	360 N·m	37,58	1	148-24
27 mm	14x18 mm	360 N·m	37,58	1	148-27
28 mm	14x18 mm	360 N·m	42,60	1	148-28
30 mm	14x18 mm	360 N·m	42,60	1	148-30
32 mm	14x18 mm	360 N·m	42,60	1	148-32
34 mm	14x18 mm	360 N·m	46,37	1	148-34
36 mm	14x18 mm	360 N·m	46,37	1	148-36
41 mm	14x18 mm	360 N·m	46,37	1	148-41
24 mm	24x32 mm	1200 N·m	195,46	1	248-24
27 mm	24x32 mm	1200 N·m	195,46	1	248-27
30 mm	24x32 mm	1200 N·m	200,47	1	248-30
32 mm	24x32 mm	1200 N·m	200,47	1	248-32
34 mm	24x32 mm	1200 N·m	200,47	1	248-34
36 mm	24x32 mm	1200 N·m	204,23	1	248-36
41 mm	24x32 mm	1200 N·m	214,26	1	248-41
46 mm	24x32 mm	1200 N·m	209,25	1	248-46
50 mm	24x32 mm	1200 N·m	209,25	1	248-50
55 mm	24x32 mm	1200 N·m	255,59	1	248-55
60 mm	24x32 mm	1200 N·m	255,59	1	248-60
30 mm	27x36 mm	3000 N·m	243,06	1	278-30
32 mm	27x36 mm	1240 N·m	243,06	1	278-32
34 mm	27x36 mm	3000 N·m	243,06	1	278-34
36 mm	27x36 mm	3000 N·m	246,82	1	278-36
41 mm	27x36 mm	3000 N·m	259,35	1	278-41





BAHCO

			€		
46 mm	27x36 mm	3000 N·m	253,09	1	278-46
50 mm	27x36 mm	3000 N·m	253,09	1	278-50
55 mm	27x36 mm	3000 N·m	255,59	1	278-55
60 mm	27x36 mm	3000 N·m	255,59	1	278-60

Chave de luneta (sistema imperial) com conector retangular







9/14/24/278"





			€		
1/4 in	9x12 mm	25 N·m	30,08	1	98-1/4
5/16 in	9x12 mm	34 N·m	30,08	1	98-5/16
3/8 in	9x12 mm	58 N·m	30,08	1	98-3/8
7/16 in	9x12 mm	72 N·m	30,08	1	98-7/16
1/2 in	9x12 mm	105 N·m	30,08	1	98-1/2
9/16 in	9x12 mm	125 N·m	30,08	1	98-9/16
5/8 in	9x12 mm	160 N·m	30,08	1	98-5/8
11/16 in	9x12 mm	160 N·m	30,08	1	98-11/16
3/4 in	9x12 mm	57 N·m	30,08	1	98-3/4
13/16 in	14x18 mm	330 N·m	42,60	1	148-13/16
13/16 in	9x12 mm	160 N·m	31,33	1	98-13/16
7/8 in	9x12 mm	160 N·m	31,33	1	98-7/8
1/2 in	14x18 mm	105 N·m	35,08	1	148-1/2
9/16 in	14x18 mm	150 N·m	35,08	1	148-9/16
5/8 in	14x18 mm	175 N·m	35,08	1	148-5/8
11/16 in	14x18 mm	230 N·m	35,08	1	148-11/16
3/4 in	14x18 mm	260 N·m	35,08	1	148-3/4
15/16 in	14x18 mm	360 N·m	42,60	1	148-15/16
7/8 in	14x18 mm	360 N·m	42,60	1	148-7/8
1 in	14x18 mm	360 N·m	42,60	1	148-1

Chave de boca sextavada com conector de retangular







99 in

			€		
3/8 in	9x12 mm	9 N·m	33,84	1	99-3/8
7/16 in	9x12 mm	16 N·m	33,84	1	99-7/16
1/2 in	9x12 mm	28 N·m	33,84	1	99-1/2

			€		
9/16 in	9x12 mm	31 N·m	33,84	1	99-9/16
5/8 in	9x12 mm	46 N·m	33,84	1	99-5/8
11/16 in	9x12 mm	65 N·m	35,08	1	99-11/16
3/4 in	9x12 mm	74 N·m	35,08	1	99-3/4





Chave de boca sextavada com conector de retangular



			€		
10 mm	9x12 mm	14 N·m	31,33	1	99-10
11 mm	9x12 mm	19 N·m	31,33	1	99-11
12 mm	9x12 mm	24 N·m	31,33	1	99-12
13 mm	9x12 mm	30 N·m	31,33	1	99-13
14 mm	9x12 mm	37 N·m	31,33	1	99-14
16 mm	9x12 mm	46 N·m	32,57	1	99-16
17 mm	9x12 mm	55 N·m	32,57	1	99-17
18 mm	9x12 mm	65 N·m	32,57	1	99-18
19 mm	9x12 mm	74 N·m	32,57	1	99-19
21 mm	9x12 mm	87 N·m	32,57	1	99-21
22 mm	9x12 mm	96 N·m	32,57	1	99-22
24 mm	9x12 mm	96 N·m	36,34	1	99-24

Adaptadores de conector retangular para aumento e redução







			€		
9x12 mm	14x18 mm	160 N·m	58,89	1	9A-14
14x18 mm	9x12 mm	160 N·m	75,18	1	14A-9
14x18 mm	24x32 mm	360 N·m	102,74	1	14A-32
24x32 mm	14x18 mm	360 N·m	111,51	1	24A-14
24x32 mm	27x36 mm	1200 N·m	176,67	1	24A-27
27x36 mm	24x32 mm	1200 N·m	209,25	1	27A-24

Adaptador para soldar com conector retangular







9/14/24W

		€		
9x12 mm	23.8 mm	40,46	1	9W
14x18 mm	38 mm	42,60	1	14W
24x32 mm	65 mm	68,92	1	24W

Cabeça de roquete de tipo redondo com conector de espigão







16R/22R

			€		
1/4" in	16 mm	20 N·m	101,01	1	16R-1/4
3/8" in	16 mm	160 N·m	101,01	1	16R-3/8
1/2" in	16 mm	420 N·m	101,01	1	16R-1/2
3/4" in	22 mm	1200 N·m	256,52	1	22R-3/4

Cabeça fixa com encaixe quadrado e conector de espigão



16F/22F





			€		
1/4" in	16 mm	20 N·m	79,54	1	16F-1/4
3/8" in	16 mm	160 N·m	79,54	1	16F-3/8
1/2" in	16 mm	420 N·m	79,54	1	16F-1/2
3/4" in	22 mm	1200 N·m	250,98	1	22F-3/4



Chave de boca com escala métrica e conector de espigão







167/227

			€		
7 mm	16 mm	9 N·m	52,51	1	167-7
8 mm	16 mm	13 N·m	52,51	1	167-8
9 mm	16 mm	18 N·m	52,51	1	167-9
10 mm	16 mm	24 N·m	52,51	1	167-10
11 mm	16 mm	32 N·m	52,51	1	167-11
12 mm	16 mm	41 N·m	54,26	1	167-12
13 mm	16 mm	51 N·m	54,26	1	167-13
14 mm	16 mm	63 N·m	54,26	1	167-14
15 mm	16 mm	77 N·m	54,26	1	167-15
16 mm	16 mm	92 N·m	55,63	1	167-16
17 mm	16 mm	109 N·m	55,63	1	167-17
18 mm	16 mm	125 N·m	59,93	1	167-18
19 mm	16 mm	145 N·m	65,12	1	167-19
20 mm	16 mm	160 N·m	65,36	1	167-20
21 mm	16 mm	190 N·m	70,75	1	167-21
22 mm	16 mm	220 N·m	88,47	1	167-22
23 mm	16 mm	250 N·m	88,47	1	167-23
24 mm	16 mm	280 N·m	88,47	1	167-24
25 mm	16 mm	320 N·m	106,91	1	167-25
26 mm	16 mm	360 N·m	106,91	1	167-26
27 mm	16 mm	360 N·m	106,91	1	167-27
28 mm	16 mm	360 N·m	106,91	1	167-28
30 mm	16 mm	360 N·m	106,91	1	167-30
32 mm	16 mm	360 N·m	106,91	1	167-32
36 mm	16 mm	360 N·m	132,55	1	167-36
22 mm	22 mm	1200 N·m	201,54	1	227-22
24 mm	22 mm	1200 N·m	207,53	1	227-24
27 mm	22 mm	1200 N·m	213,62	1	227-27
30 mm	22 mm	1200 N·m	222,35	1	227-30
32 mm	22 mm	1200 N·m	226,60	1	227-32
34 mm	22 mm	1200 N·m	250,13	1	227-34
36 mm	22 mm	1200 N·m	256,50	1	227-36
41 mm	22 mm	1200 N·m	278,00	1	227-41
46 mm	22 mm	1200 N·m	333,50	1	227-46

Chave de boca com escala imperial e conector de espigão







167





			€		
5/16 in	16 mm	34 N·m	55,86	1	167-5/16
3/8 in	16 mm	45 N·m	55,86	1	167-3/8
7/16 in	16 mm	72 N·m	57,73	1	167-7/16
1/2 in	16 mm	51 N·m	57,73	1	167-1/2
9/16 in	16 mm	77 N·m	57,73	1	167-9/16
5/8 in	16 mm	92 N·m	59,15	1	167-5/8
11/16 in	16 mm	109 N·m	56,19	1	167-11/16
3/4 in	16 mm	145 N·m	65,98	1	167-3/4
13/16 in	16 mm	190 N·m	75,28	1	167-13/16
7/8 in	16 mm	220 N·m	94,08	1	167-7/8
15/16 in	16 mm	280 N·m	94,08	1	167-15/16
1 in	16 mm	360 N·m	113,71	1	167-1
1.1/16 in	16 mm	360 N·m	113,71	1	167-1.1/16
1.1/8 in	16 mm	360 N·m	113,71	1	167-1.1/8
1.3/16 in	16 mm	360 N·m	113,71	1	167-1.3/16
1.1/4 in	16 mm	360 N·m	113,71	1	167-1.1/4

Chave de luneta (sistema métrico) com conector de espigão



168/228





			€		
7 mm	16 mm	25 N·m	55,11	1	168-7
8 mm	16 mm	34 N·m	55,11	1	168-8
9 mm	16 mm	45 N·m	55,11	1	168-9
10 mm	16 mm	58 N·m	55,11	1	168-10
11 mm	16 mm	72 N·m	55,11	1	168-11
12 mm	16 mm	89 N·m	56,95	1	168-12

			€		
mm	mm	máx			
13 mm	16 mm	105 N·m	56,95	1	168-13
14 mm	16 mm	125 N·m	56,95	1	168-14
15 mm	16 mm	150 N·m	56,95	1	168-15
16 mm	16 mm	175 N·m	58,40	1	168-16
17 mm	16 mm	200 N·m	58,40	1	168-17
18 mm	16 mm	230 N·m	62,86	1	168-18
19 mm	16 mm	260 N·m	65,12	1	168-19
20 mm	16 mm	290 N·m	68,64	1	168-20
21 mm	16 mm	330 N·m	74,23	1	168-21
22 mm	16 mm	360 N·m	92,84	1	168-22
23 mm	16 mm	360 N·m	92,84	1	168-23
24 mm	16 mm	360 N·m	92,84	1	168-24
26 mm	16 mm	360 N·m	112,30	1	168-26
27 mm	16 mm	360 N·m	112,30	1	168-27
22 mm	22 mm	1200 N·m	224,50	1	228-22
24 mm	22 mm	1200 N·m	224,50	1	228-24
27 mm	22 mm	1200 N·m	224,50	1	228-27
30 mm	22 mm	1200 N·m	233,43	1	228-30
32 mm	22 mm	1200 N·m	238,02	1	228-32
34 mm	22 mm	1200 N·m	255,96	1	228-34
36 mm	22 mm	1200 N·m	269,40	1	228-36
41 mm	22 mm	1200 N·m	291,83	1	228-41
46 mm	22 mm	1200 N·m	350,20	1	228-46

Chave de luneta (sistema imperial) com conector de espigão







168

			€		
in	mm	máx			
5/16 in	16 mm	34 N·m	58,64	1	168-5/16
3/8 in	16 mm	58 N·m	58,64	1	168-3/8
7/16 in	16 mm	89 N·m	58,64	1	168-7/16
1/2 in	16 mm	105 N·m	60,55	1	168-1/2
9/16 in	16 mm	125 N·m	60,55	1	168-9/16
5/8 in	16 mm	125 N·m	62,11	1	168-5/8
11/16 in	16 mm	125 N·m	56,19	1	168-11/16
3/4 in	16 mm	260 N·m	73,02	1	168-3/4
13/16 in	16 mm	290 N·m	73,02	1	168-13/16
7/8 in	16 mm	360 N·m	98,77	1	168-7/8
15/16 in	16 mm	360 N·m	98,77	1	168-15/16
1 in	16 mm	360 N·m	119,42	1	168-1
1.1/16 in	16 mm	360 N·m	119,42	1	168-1.1/16
1.3/16 in	16 mm	360 N·m	140,10	1	168-1.3/16

Chave de boca sextavada (sistema métrico) com conector de espigão



169

			€		
mm	mm	máx			
7 mm	16 mm	6 N·m	57,89	1	169-7
8 mm	16 mm	8 N·m	57,89	1	169-8
9 mm	16 mm	10 N·m	57,89	1	169-9
10 mm	16 mm	12 N·m	57,89	1	169-10
11 mm	16 mm	16 N·m	57,89	1	169-11
12 mm	16 mm	16 N·m	59,88	1	169-12
13 mm	16 mm	28 N·m	59,88	1	169-13
14 mm	16 mm	31 N·m	59,88	1	169-14
15 mm	16 mm	38 N·m	59,88	1	169-15
16 mm	16 mm	46 N·m	61,25	1	169-16
17 mm	16 mm	53 N·m	61,25	1	169-17
18 mm	16 mm	65 N·m	66,06	1	169-18
19 mm	16 mm	74 N·m	68,40	1	169-19
20 mm	16 mm	86 N·m	72,00	1	169-20
21 mm	16 mm	100 N·m	77,99	1	169-21
22 mm	16 mm	115 N·m	97,56	1	169-22
23 mm	16 mm	125 N·m	97,56	1	169-23
24 mm	16 mm	145 N·m	97,56	1	169-24
27 mm	16 mm	160 N·m	117,82	1	169-27

ESTOJOS VAZIOS PARA FERRAMENTAS DE TORQUE

Caixas vazias de parede dupla com absorção de choque para ferramentas de torque



4750BMCT

	€		
kg			
0.95 kg	30,80	1	4750BMCT1





BAHCO



Acessórios para Máquinas



SERRAS CRANIANAS

Serras craneanas de bimetel Sandflex® para metal/placas de madeira de 14 mm-210 mm



3830

	€		
14 mm	11,87	1	3830-14-C
16 mm	11,87	1	3830-16-C
17 mm	11,87	1	3830-17-C
19 mm	11,87	1	3830-19-C
20 mm	11,87	1	3830-20-C
21 mm	11,87	1	3830-21-C
22 mm	11,87	1	3830-22-C
24 mm	11,87	1	3830-24-C
25 mm	11,99	1	3830-25-C
27 mm	12,63	1	3830-27-C
29 mm	12,63	1	3830-29-C
30 mm	12,63	1	3830-30-C
32 mm	12,63	1	3830-32-C
33 mm	12,63	1	3830-33-C
35 mm	14,28	1	3830-35-C
37 mm	14,28	1	3830-37-C
38 mm	14,28	1	3830-38-C
40 mm	14,28	1	3830-40-C
41 mm	14,28	1	3830-41-C
43 mm	14,28	1	3830-43-C
44 mm	16,30	1	3830-44-C
46 mm	16,30	1	3830-46-C
48 mm	16,30	1	3830-48-C
50 mm	16,30	1	3830-50-C
51 mm	16,30	1	3830-51-C
52 mm	19,70	1	3830-52-C
54 mm	19,70	1	3830-54-C
55 mm	19,70	1	3830-55-C
56 mm	19,70	1	3830-56-C
57 mm	19,70	1	3830-57-C
59 mm	19,70	1	3830-59-C
60 mm	19,70	1	3830-60-C
64 mm	21,73	1	3830-64-C
65 mm	21,73	1	3830-65-C
67 mm	21,73	1	3830-67-C
68 mm	21,73	1	3830-68-C
70 mm	21,73	1	3830-70-C
73 mm	21,73	1	3830-73-C
76 mm	24,63	1	3830-76-C
79 mm	24,63	1	3830-79-C
83 mm	24,63	1	3830-83-C
86 mm	24,63	1	3830-86-C
89 mm	24,63	1	3830-89-C
92 mm	28,54	1	3830-92-C
95 mm	30,94	1	3830-95-C
98 mm	32,34	1	3830-98-C
102 mm	34,74	1	3830-102-C
105 mm	36,63	1	3830-105-C
108 mm	42,82	1	3830-108-C

	€		
111 mm	49,89	1	3830-111-C
114 mm	55,58	1	3830-114-C
121 mm	61,89	1	3830-121-C
127 mm	67,57	1	3830-127-C
133 mm	72,62	1	3830-133-C
140 mm	77,67	1	3830-140-C
146 mm	80,83	1	3830-146-C
152 mm	88,41	1	3830-152-C
14 mm	11,87	6	3830-14-VIP
16 mm	11,87	6	3830-16-VIP
17 mm	11,87	6	3830-17-VIP
19 mm	11,87	6	3830-19-VIP
20 mm	11,87	6	3830-20-VIP
21 mm	11,87	6	3830-21-VIP
22 mm	11,87	6	3830-22-VIP
24 mm	11,87	6	3830-24-VIP
25 mm	11,99	6	3830-25-VIP
27 mm	12,63	6	3830-27-VIP
29 mm	12,63	6	3830-29-VIP
30 mm	12,63	6	3830-30-VIP
32 mm	12,63	6	3830-32-VIP
33 mm	12,63	6	3830-33-VIP
35 mm	14,28	6	3830-35-VIP
37 mm	14,28	6	3830-37-VIP
38 mm	14,28	6	3830-38-VIP
40 mm	14,28	6	3830-40-VIP
41 mm	14,28	6	3830-41-VIP
43 mm	14,28	6	3830-43-VIP
44 mm	16,30	6	3830-44-VIP
46 mm	16,30	6	3830-46-VIP
48 mm	16,30	6	3830-48-VIP
50 mm	16,30	6	3830-50-VIP
51 mm	16,30	6	3830-51-VIP
52 mm	19,70	4	3830-52-VIP
54 mm	19,70	4	3830-54-VIP
55 mm	19,70	4	3830-55-VIP
56 mm	19,70	4	3830-56-VIP
57 mm	19,70	4	3830-57-VIP
59 mm	19,70	4	3830-59-VIP
60 mm	19,70	4	3830-60-VIP
62 mm	21,45	4	3830-62-VIP
64 mm	21,73	4	3830-64-VIP
65 mm	21,73	4	3830-65-VIP
67 mm	21,73	4	3830-67-VIP
68 mm	21,73	4	3830-68-VIP
70 mm	21,73	4	3830-70-VIP
73 mm	21,73	4	3830-73-VIP
76 mm	24,63	4	3830-76-VIP
79 mm	24,63	4	3830-79-VIP
83 mm	24,63	4	3830-83-VIP
86 mm	24,63	4	3830-86-VIP
89 mm	24,63	4	3830-89-VIP
92 mm	28,54	4	3830-92-VIP
95 mm	30,94	4	3830-95-VIP
98 mm	32,34	4	3830-98-VIP
102 mm	34,74	4	3830-102-VIP
105 mm	36,63	4	3830-105-VIP
108 mm	42,82	4	3830-108-VIP
111 mm	49,89	4	3830-111-VIP
114 mm	55,58	4	3830-114-VIP
121 mm	61,89	1	3830-121-VIP
127 mm	67,57	1	3830-127-VIP
133 mm	72,62	1	3830-133-VIP
140 mm	77,67	1	3830-140-VIP
146 mm	80,83	1	3830-146-VIP
152 mm	88,41	1	3830-152-VIP
168 mm	114,84	1	3830-168
177 mm	158,10	1	3830-177-HIGH
210 mm	172,27	1	3830-210

Serras craneanas de bimetel Sandflex®, conjunto de 4



3830-4P

X		€		
4	19 mm	17,52	1	3830-19-4P
4	20 mm	18,67	1	3830-20-4P
4	22 mm	30,97	1	3830-22-4P
4	25 mm	34,13	1	3830-25-4P
4	27 mm	32,45	1	3830-27-4P
4	29 mm	32,72	1	3830-29-4P
4	30 mm	33,00	1	3830-30-4P
4	32 mm	35,04	1	3830-32-4P
4	35 mm	35,82	1	3830-35-4P

Conjunto de serras craneanas em bimetel Sandflex® 20x4 mm + 25x4 mm - 11 peças



3834-CP-20/25

g	€		
600 g	62,88	1	3834-CP-20/25

3830-20-Cx 4, 3830-25-Cx 4

3834-ARBR-930

3834-DRLx 2



Conjunto de serras craneanas em bimetel Sandflex® de 20 mm-76 mm - 10 peças



3834-PROMO-82

	€		
1188 g	91,19	1	3834-PROMO-82

- 3830-20-C, 3830-25-C, 3830-30-C, 3830-35-C, 3830-44-C, 3830-51-C, 3830-64-C, 3830-76-C
- 3834-ARBR-930
- 3834-ARBR-11152QC

Conjunto de serras craneanas em bimetel Sandflex® de 16 mm-44 mm - 14 peças



3834-PROMO-122

	€		
1100 g	110,00	1	3834-PROMO-122

- 3830-16-C, 3830-20-Cx 2, 3830-22-C, 3830-25-Cx 2, 3830-29-C, 3830-32-C, 3830-35-Cx 2, 3830-38-C, 3830-44-C
- 3834-ARBR-930
- 3834-ARBR-11152QC

Conjunto de serras craneanas em bimetel Sandflex® de 19 mm-76 mm - 14 peças



3834-PROMO-122-76

	€		
1441 g	120,08	1	3834-PROMO-122-76

- 3830-19-C, 3830-20-C, 3830-22-C, 3830-25-C, 3830-27-C, 3830-32-C, 3830-35-C, 3830-38-C, 3830-40-C, 3830-51-C, 3830-64-C, 3830-76-C
- 3834-ARBR-930
- 3834-ARBR-9100

Conjunto de serras craneanas em bimetel Sandflex® de 35 mm-83 mm - 9 peças



3834-SET-72-35/83

	€		
1613 g	125,18	1	3834-SET-72-35/83

- 3830-35-C, 3830-40-C, 3830-44-C, 3830-51-C, 3830-57-C, 3830-68-C, 3830-83-C
- 3834-ARBR-9100
- 3834-DRL

Conjunto de serras craneanas + árvores



3834-42

	€		
2025 g	149,90	1	3834-SET-42

- 3830-51-VIP, 3830-76-VIP, 3830-86-VIP, 3830-111-VIP
- 3834-ARBR-9100
- 3834-ES

Conjunto Serras Craneanas 13 peças



3834-53

	€		
2370 g	218,37	1	3834-SET-53

- 3830-19-VIP, 3830-22-VIP, 3830-25-VIP, 3830-29-VIP, 3830-30-VIP, 3830-35-VIP, 3830-37-VIP, 3830-41-VIP, 3830-52-VIP, 3830-60-VIP, 3830-79-VIP
- 3834-ARBR-930
- 3834-ARBR-9100



Serras craneanas



3834-61

	€		
3145 g	183,16	1	3834-SET-61

3830-44-VIP, 3830-51-VIP, 3830-57-VIP, 3830-73-VIP, 3830-86-VIP, 3830-114-VIP	
3834-ARBR-9100	

Conjunto de serras craneanas



3834-62-16/50

	€		
1065 g	117,04	1	3834-SET-62-16/50

3830-16-VIP, 3830-20-VIP, 3830-25-VIP, 3830-32-VIP, 3830-40-VIP, 3830-50-VIP	
3834-ARBR-9100	
3834-ARBR-930	

Conjunto de serras craneanas + árvores



3834-65-22/64

	€		
1625 g	151,95	1	3834-SET-65-22/64

3830-22-VIP, 3830-29-VIP, 3830-35-VIP, 3830-44-VIP, 3830-51-VIP, 3830-64-VIP	
3834-ARBR-1130	
3834-ARBR-11152	
3834-DRL	

Conjunto de serras craneanas + árvores



3834-62

	€		
1050 g	122,46	1	3834-SET-62

3830-19-VIP, 3830-21-VIP, 3830-22-VIP, 3830-29-VIP, 3830-38-VIP, 3830-48-VIP	
3834-ARBR-930	
3834-ARBR-9100	

Conjunto de serras craneanas + árvores



3834-65-16/51

	€		
1465 g	136,54	1	3834-SET-65-16/51

3830-16-VIP, 3830-20-VIP, 3830-25-VIP, 3830-32-VIP, 3830-40-VIP, 3830-51-VIP	
3834-ARBR-1130	
3834-ARBR-11152	
3834-DRL	

Conjunto de serras craneanas + árvores



3834-72

	€		
1080 g	163,24	1	3834-SET-72

3830-19-VIP, 3830-22-VIP, 3830-29-VIP, 3830-35-VIP, 3830-44-VIP, 3830-51-VIP, 3830-64-VIP	
3834-ARBR-930	
3834-ARBR-9100	

Conjunto de serras craneanas



3834-73

	€		
2080 g	202,95	1	3834-SET-73

- 3830-16-VIP, 3830-22-VIP, 3830-51-VIP, 3830-57-VIP, 3830-73-VIP, 3830-76-VIP, 3830-92-VIP
- 3834-ARBR-930
- 3834-ARBR-9100

Serra craniana Sandflex® bimetálica - dimensões mais comuns em engenharia, água e saneamento e instalações elétricas



3834-SET-77

	€		
3325 g	200,30	1	3834-SET-77

- 3830-16-VIP, 3830-20-VIP, 3830-25-VIP, 3830-32-VIP, 3830-41-VIP, 3830-51-VIP, 3830-73-VIP, 3830-76-VIP, 3830-83-VIP, 3830-86-VIP
- 3834-ARBR-930
- 3834-ARBR-9100
- 3834-DRL

Conjunto de serras craneanas



3834-86

	€		
2540 g	268,80	1	3834-SET-86

- 3830-25-VIP, 3830-32-VIP, 3830-35-VIP, 3830-51-VIP, 3830-54-VIP, 3830-76-VIP, 3830-92-VIP, 3830-114-VIP
- 3834-ARBR-1130
- 3834-ARBR-11152
- 3834-DRLx 2
- 3834-ADP

Conjunto Serras Craneanas 9 peças



3834-73-22/68

	€		
2170 g	151,43	1	3834-SET-73-22/68

- 3830-22-VIP, 3830-29-VIP, 3830-35-VIP, 3830-44-VIP, 3830-51-VIP, 3830-64-VIP, 3830-68-VIP
- 3834-ARBR-1130
- 3834-ARBR-11152
- 3834-DRL

Conjunto de serras craneanas em bimetálica Sandflex® para metais 25 mm-114 mm -12 peças



3834-SET-84-ES

	€		
3600 g	122,61	1	3834-SET-84-ES

- 3830-25-C, 3830-30-C, 3830-35-C, 3830-51-C, 3830-54-C, 3830-76-C, 3830-92-C, 3830-114-C
- 3834-ARBR-930ESM, 3834-ARBR-9100ESM
- 3834-DRL-HSS-ES
- 3834-UPSIZE

Conjunto de serras craneanas + árvores



3834-87

	€		
1925 g	187,87	1	3834-SET-87

- 3830-19-VIP, 3830-22-VIP, 3830-29-VIP, 3830-38-VIP, 3830-43-VIP, 3830-48-VIP, 3830-52-VIP, 3830-65-VIP
- 3834-ARBR-930
- 3834-ARBR-9100
- 3834-DRL
- 3834-ES



Conjunto de serras craneanas + árvores



3834-92

	€		
1440 g	187,88	1	3834-SET-92

3830-16-VIP, 3830-22-VIP, 3830-25-VIP, 3830-29-VIP, 3830-32-VIP, 3830-41-VIP, 3830-51-VIP, 3830-73-VIP, 3830-83-VIP	
3834-ARBR-930	
3834-ARBR-9100	

Conjunto de serras craneanas + árvores



3834-94

	€		
1815 g	174,23	1	3834-SET-94

3830-16-VIP, 3830-19-VIP, 3830-22-VIP, 3830-25-VIP, 3830-30-VIP, 3830-35-VIP, 3830-41-VIP, 3830-51-VIP, 3830-67-VIP	
3834-ARBR-1130	
3834-ARBR-11152	

Conjunto Serras Craneanas 11 peças



3834-103

	€		
2015 g	144,11	1	3834-SET-103

3830-16-VIP, 3830-19-VIP, 3830-24-VIP, 3830-29-VIP, 3830-38-VIP, 3830-44-VIP, 3830-57-VIP, 3830-67-VIP	
3834-ARBR-1130	
3834-ARBR-11152	
3834-DRL	

Conjunto de serras craneanas em bimetel Sandflex® de 16 mm-83 mm -12 peças



3834-93

	€		
2360 g	163,11	1	3834-SET-93

3830-16-VIP, 3830-20-VIP, 3830-25-VIP, 3830-32-VIP, 3830-40-VIP, 3830-51-VIP, 3830-67-VIP, 3830-76-VIP, 3830-83-VIP	
3834-ARBR-930	
3834-ARBR-9100QC	
3834-DRL	

Conjunto de serras craneanas + árvores



3834-95

	€		
1350 g	184,21	1	3834-SET-95

3830-16-VIP, 3830-19-VIP, 3830-22-VIP, 3830-29-VIP, 3830-35-VIP, 3830-44-VIP, 3830-52-VIP, 3830-57-VIP, 3830-64-VIP	
3834-ARBR-1130	
3834-ARBR-11152	
3834-DRL	

Conjunto de serra craniana



3834-SET-152

	€		
3770 g	256,76	1	3834-SET-152

3830-16-VIP, 3830-19-VIP, 3830-22-VIP, 3830-25-VIP, 3830-32-VIP, 3830-35-VIP, 3830-44-VIP, 3830-51-VIP, 3830-57-VIP, 3830-60-VIP, 3830-65-VIP, 3830-68-VIP, 3830-73-VIP, 3830-76-VIP, 3830-83-VIP	
3834-ARBR-930	
3834-ARBR-9100	
3834-DRLx 2	

Serras craneanas multi construção Superior™ para madeira e tijolos de 19 mm-225 mm



3833

	€		
19 mm	13,22	1	3833-19-C
20 mm	13,06	1	3833-20-C
22 mm	13,19	1	3833-22-C
25 mm	13,61	1	3833-25-C
27 mm	14,20	1	3833-27-C
29 mm	15,01	1	3833-29-C
30 mm	14,83	1	3833-30-C
32 mm	15,12	1	3833-32-C
35 mm	16,97	1	3833-35-C
38 mm	16,97	1	3833-38-C
40 mm	17,27	1	3833-40-C
41 mm	17,27	1	3833-41-C
44 mm	20,31	1	3833-44-C
48 mm	20,31	1	3833-48-C
51 mm	20,81	1	3833-51-C
54 mm	22,54	1	3833-54-C
56 mm	23,48	1	3833-56-C
57 mm	23,48	1	3833-57-C
60 mm	23,48	1	3833-60-C
62 mm	23,48	1	3833-62-C
64 mm	23,61	1	3833-64-C
65 mm	23,61	1	3833-65-C
67 mm	23,61	1	3833-67-C
68 mm	23,86	1	3833-68-C
70 mm	24,05	1	3833-70-C
71 mm	24,05	1	3833-71-C
73 mm	24,05	1	3833-73-C
74 mm	24,05	1	3833-74-C
76 mm	24,94	1	3833-76-C
77 mm	27,38	1	3833-77-C
78 mm	27,38	1	3833-78-C
79 mm	27,38	1	3833-79-C
83 mm	27,91	1	3833-83-C
86 mm	28,11	1	3833-86-C
89 mm	28,24	1	3833-89-C
92 mm	29,05	1	3833-92-C
95 mm	29,88	1	3833-95-C
98 mm	30,39	1	3833-98-C
102 mm	32,10	1	3833-102-C
105 mm	32,40	1	3833-105-C
108 mm	32,54	1	3833-108-C
109 mm	35,44	1	3833-109-C
111 mm	32,78	1	3833-111-C
114 mm	35,52	1	3833-114-C
121 mm	35,96	1	3833-121-C
127 mm	37,91	1	3833-127-C
133 mm	38,82	1	3833-133-C
140 mm	39,44	1	3833-140-C
152 mm	42,41	1	3833-152-C
159 mm	48,61	1	3833-159-C
168 mm	54,35	1	3833-168
177 mm	58,23	1	3833-177
210 mm	67,54	1	3833-210
225 mm	70,98	1	3833-225

Conjunto de serras craneanas para construção múltipla Superior™ de 32 mm-83 mm - 6 peças



3833-PROMO-42

g	€		
1489 g	136,04	1	3833-PROMO-42

3833-32-C, 3833-51-C, 3833-76-C, 3833-83-C	
3834-ARBR-9100EL	
3834-UPSIZEL	

Conjunto de serra craniana Superior™ - 10 peças



3833-SET-101

kg	€		
2.75 kg	311,52	1	3833-SET-101

3833-19-C, 3833-22-C, 3833-29-C, 3833-35-C, 3833-44-C, 3833-51-C, 3833-64-C	
3834-ARBR-930EL, 3834-ARBR-9100EL	
3834-DRL-EL	

Conjunto de serra craniana Superior™ - 14 peças



3833-SET-201

kg	€		
4.35 kg	353,86	1	3833-SET-201

3833-19-C, 3833-20-C, 3833-25-C, 3833-32-C, 3833-41-C, 3833-51-C, 3833-73-C, 3833-76-C, 3833-83-C, 3833-86-C	
3834-ARBR-930EL, 3834-ARBR-9100EL	
3834-DRL-EL	
3834-UPSIZEL	

Conjunto de serra craniana Superior™ - 14 peças



3833-SET-202

kg	€		
4.1 kg	348,92	1	3833-SET-202

3833-19-C, 3833-20-C, 3833-25-C, 3833-32-C, 3833-41-C, 3833-51-C, 3833-57-C, 3833-60-C, 3833-73-C, 3833-83-C	
3834-ARBR-930EL, 3834-ARBR-9100EL	
3834-DRL-EL	
3834-UPSIZEL	



Conjunto de serra craniana Superior™ - 14 peças



3833-SET-203

	€		
4.65 kg	348,92	1	3833-SET-203

3833-19-C, 3833-22-C, 3833-54-C, 3833-56-C, 3833-57-C, 3833-62-C, 3833-68-C, 3833-71-C, 3833-74-C, 3833-78-C	
3834-ARBR-930EL, 3834-ARBR-9100EL	
3834-DRL-EL	
3834-UPSIZE	

Conjunto de serra craniana Superior™ - 9 peças



3833-SET-205

	€		
2.81 kg	263,46	1	3833-SET-205

3833-22-C, 3833-35-C, 3833-44-C, 3833-51-C, 3833-67-C	
3834-ARBR-930EL, 3834-ARBR-9100EL	
3834-DRL-EL	
3834-UPSIZE	

Conjunto de serra craniana Superior™ - 15 peças



3833-SET-208

	€		
3.72 kg	360,52	1	3833-SET-208

3833-19-C, 3833-22-C, 3833-25-C, 3833-32-C, 3833-35-C, 3833-38-C, 3833-44-C, 3833-51-C, 3833-57-C, 3833-68-C, 3833-76-C	
3834-ARBR-930EL, 3834-ARBR-9100EL	
3834-DRL-EL	
3834-UPSIZE	

Conjunto de serra craniana Superior™ - 10 peças



3833-SET-204

	€		
3.88 kg	314,44	1	3833-SET-204

3833-32-C, 3833-41-C, 3833-51-C, 3833-73-C, 3833-76-C, 3833-83-C, 3833-86-C	
3834-ARBR-9100EL	
3834-DRL-EL	
3834-UPSIZE	

Conjunto de serra craniana Superior™ - 14 peças



3833-SET-207

	€		
3.90 kg	353,28	1	3833-SET-207

3833-19-C, 3833-22-C, 3833-25-C, 3833-35-C, 3833-44-C, 3833-51-C, 3833-64-C, 3833-67-C, 3833-76-C, 3833-83-C	
3834-ARBR-930EL, 3834-ARBR-9100EL	
3834-DRL-EL	
3834-UPSIZE	

Conjunto de serra craniana Superior™ - 12 peças



3833-SET-301

	€		
4.38 kg	334,19	1	3833-SET-301

3833-25-C, 3833-32-C, 3833-35-C, 3833-51-C, 3833-54-C, 3833-76-C, 3833-92-C, 3833-114-C	
3834-ARBR-930EL, 3834-ARBR-9100EL	
3834-DRL-EL	
3834-UPSIZE	

Conjunto de serra craniana Superior™ - 7 peças



3833-SET-302

kg	€		
3.51 kg	218,39	1	3833-SET-302

3833-51-C, 3833-76-C, 3833-86-C, 3833-111-C	
3834-ARBR-9100EL	
3834-DRL-EL	
3834-UPSIZE	

Conjunto de serra craniana Superior™ - 11 peças



3833-SET-303

kg	€		
4.17 kg	280,43	1	3833-SET-303

3833-35-C, 3833-40-C, 3833-51-C, 3833-57-C, 3833-60-C, 3833-74-C, 3833-83-C, 3833-105-C	
3834-ARBR-9100EL	
3834-DRL-EL	
3834-UPSIZE	

Conjunto de serra craniana Superior™ - 13 peças



3833-SET-304

kg	€		
4.20 kg	347,22	1	3833-SET-304

3833-19-C, 3833-25-C, 3833-32-C, 3833-35-C, 3833-51-C, 3833-54-C, 3833-76-C, 3833-92-C, 3833-114-C	
3834-ARBR-930EL, 3834-ARBR-9100EL	
3834-DRL-EL	
3834-UPSIZE	

Serras craneanas. Dentes com carboneto de tungsténio (CT)



3832

kg	€		
14 mm	20,00	6	3832-14
16 mm	20,00	6	3832-16
17 mm	20,00	6	3832-17
19 mm	20,00	6	3832-19

	€		
20 mm	20,00	6	3832-20
21 mm	20,00	6	3832-21
22 mm	20,00	6	3832-22
24 mm	20,00	6	3832-24
25 mm	21,09	6	3832-25
27 mm	22,54	6	3832-27
29 mm	22,54	6	3832-29
30 mm	22,54	6	3832-30
32 mm	22,54	6	3832-32
33 mm	22,54	6	3832-33
35 mm	25,08	6	3832-35
37 mm	25,08	6	3832-37
38 mm	25,08	6	3832-38
40 mm	25,08	6	3832-40
41 mm	25,08	6	3832-41
43 mm	25,08	6	3832-43
44 mm	29,09	6	3832-44
46 mm	29,09	6	3832-46
48 mm	29,09	6	3832-48
51 mm	29,09	6	3832-51
52 mm	35,28	4	3832-52
54 mm	35,28	4	3832-54
56 mm	35,28	4	3832-56
57 mm	35,28	4	3832-57
59 mm	35,28	4	3832-59
60 mm	35,28	4	3832-60
64 mm	38,90	4	3832-64
65 mm	38,90	4	3832-65
67 mm	38,90	4	3832-67
68 mm	38,90	4	3832-68
70 mm	38,90	4	3832-70
73 mm	38,90	4	3832-73
76 mm	43,28	4	3832-76
79 mm	43,28	4	3832-79
83 mm	43,28	4	3832-83
86 mm	43,28	4	3832-86
89 mm	43,28	4	3832-89
92 mm	50,17	4	3832-92
95 mm	54,91	4	3832-95
98 mm	58,18	4	3832-98
102 mm	61,07	4	3832-102
105 mm	65,43	4	3832-105
108 mm	76,72	4	3832-108
111 mm	88,73	4	3832-111
114 mm	98,54	4	3832-114
121 mm	109,46	1	3832-121
127 mm	120,37	1	3832-127
133 mm	130,55	1	3832-133
140 mm	141,46	1	3832-140
146 mm	148,71	1	3832-146
152 mm	161,80	1	3832-152

Dentes com carboneto de tungsténio (CT)



Serras craneanas com ponta de carboneto para aço inoxidável 16-127mm



3832-C

	€		
16 mm	20,00	1	3832-16-C
19 mm	20,00	1	3832-19-C
20 mm	20,00	1	3832-20-C
22 mm	20,00	1	3832-22-C
24 mm	20,00	1	3832-24-C
25 mm	21,10	1	3832-25-C
29 mm	22,54	1	3832-29-C
30 mm	22,54	1	3832-30-C
32 mm	22,54	1	3832-32-C
35 mm	25,08	1	3832-35-C
38 mm	25,08	1	3832-38-C
41 mm	25,08	1	3832-41-C
44 mm	29,09	1	3832-44-C
46 mm	29,09	1	3832-46-C
48 mm	29,09	1	3832-48-C
51 mm	29,09	1	3832-51-C
54 mm	35,28	1	3832-54-C
57 mm	35,28	1	3832-57-C
60 mm	35,28	1	3832-60-C
64 mm	38,91	1	3832-64-C
73 mm	38,91	1	3832-73-C
76 mm	43,28	1	3832-76-C
83 mm	43,28	1	3832-83-C
86 mm	43,28	1	3832-86-C
92 mm	50,17	1	3832-92-C
102 mm	71,54	1	3832-102-C
114 mm	115,41	1	3832-114-C
127 mm	127,79	1	3832-127-C

Conjuntos de serras de ponta de carboneto para aço inoxidável 25 mm -114 mm - 12 peças



3832-SET-84-ES

g	€		
3600 g	231,75	1	3832-SET-84-ES

3832-25-C, 3832-30-C, 3832-35-C, 3832-51-C, 3832-54-C, 3832-76-C, 3832-92-C, 3832-114-C	
3834-ARBR-9100ESM, 3834-ARBR-930ESM	
3834-DRL-HSS-ES	
3834-UPSIZ	

Conjuntos de serras craneanas com ponta de carboneto para aço inoxidável 16 mm-114 mm - 20 peças



3832-SET-164-ES

g	€		
4800 g	383,37	1	3832-SET-164-ES

3832-16-C, 3832-20-C, 3832-25-C, 3832-32-C, 3832-35-C, 3832-41-C, 3832-44-C, 3832-46-C, 3832-51-C, 3832-54-C, 3832-73-C, 3832-76-C, 3832-83-C, 3832-86-C, 3832-92-C, 3832-114-C	
3834-ARBR-9100ESM, 3834-ARBR-930ESM	
3834-DRL-HSS-ES	
3834-UPSIZ	

Conjunto de serras craneanas, misto 35 mm-114 mm - 10 peças



3835-SET-64

X	g	€		
10	3870 g	252,92	1	3835-SET-64

3830-35-C, 3830-73-C	
3833-35-C, 3833-73-C, 3833-76-C, 3833-114-C	
3834-ARBR-9100QC-C	
3834-ARBR-9100EL	
3834-DRL-EL	
3834-DRL	

Conjunto de serras craneanas, misto 12 mm-86 mm - 18 peças



3835-SET-711

X	g	€		
18	3680 g	265,55	1	3835-SET-711

3830-35-C, 3830-41-C, 3830-51-C, 3830-73-C, 3830-76-C, 3830-83-C, 3830-86-C	
9629-12, 9629-14, 9629-16, 9629-18, 9629-20, 9629-22, 9629-25, 9629-28, 9629-32	
3834-ARBR-9100ESM	
3834-DRL-HSS-ES	

Árvores com função ejetora para facilitar a remoção da parte central



3834-ARBR-EL/ES

		€		
19-30 mm	8.5 mm	41,86	1	3834-ARBR-930EL
32-159 mm	8.5 mm	42,59	1	3834-ARBR-9100EL
16-30 mm	8.5 mm	41,26	1	3834-ARBR-930ESM
32-152 mm	8.5 mm	43,25	1	3834-ARBR-9100ESM

Broca piloto integral com ponta de carboneto integrada para árvores 930EL e 9100EL



3834-DRL-EL

Ø	L	€		
6.35 mm	202 mm	9,40	1	3834-DRL-EL

Brocas piloto para mandris curtos de ejeção rápida



3834-DRL-HSS-ES

Ø	L	€	Icon 1	Icon 2
6.35 mm	138 mm	9,01	1	3834-DRL-ES
6.35 mm	138 mm	15,88	1	3834-DRL-HSS-ES

Adaptador para alargar furos existentes



3834-upsizer

L	€	Icon 1	Icon 2
20.5 mm	4,43	1	3834-UPSIZER

Árvores



3834-ARBR

Ø	L	€	Icon 1	Icon 2
14-30 mm	6.4 mm	11,81	1	3834-ARBR-630
14-30 mm	6.4 mm	12,39	1	3834-ARBR-630-C
14-30 mm	6.4 mm	9,44	1	3834-ARBR-730
14-30 mm	6.4 mm	9,93	1	3834-ARBR-730-C
14-30 mm	8.5 mm	11,81	1	3834-ARBR-930
14-30 mm	8.5 mm	12,39	1	3834-ARBR-930-C
14-30 mm	11.1 mm	13,63	4	3834-ARBR-1130
14-30 mm	11.1 mm	14,31	1	3834-ARBR-1130-C

Árvore com função de substituição rápida



3834-ARBR-QC

Ø	L	€	Icon 1	Icon 2
32-152 mm	8.5 mm	24,73	1	3834-ARBR-9100
32-152 mm	8.5 mm	25,98	1	3834-ARBR-9100-C
32-152 mm	8.5 mm	21,09	1	3834-ARBR-9100QC
32-152 mm	8.5 mm	22,38	1	3834-ARBR-9100QC-C
32-210 mm	11.1 mm	24,73	1	3834-ARBR-11152
32-210 mm	11.1 mm	25,98	1	3834-ARBR-11152-C
32-210 mm	11.1 mm	21,09	1	3834-ARBR-11152QC
32-210 mm	11.1 mm	22,16	1	3834-ARBR-11152QC-C
32-210 mm	15.4 mm	24,73	1	3834-ARBR-16152
32-210 mm	15.4 mm	23,11	1	3834-ARBR-16152QC

Árvores para máquinas de mudança rápida. Árvores para máquinas de mudança rápida



3834-ARBR-SD

Ø	L	€	Icon 1	Icon 2
14-30 mm	SDS+ mm	14,54	1	3834-ARBR-SD30
32-210 mm	SDS+ mm	26,19	1	3834-ARBR-SD152QC

Árvores para máquinas de mudança rápida

Broca-guia. Broca-Guia



3834-DRL

Ø	L	€	Icon 1	Icon 2
6.35 mm	81 mm	5,65	1	3834-DRL

Broca-Guia

Brocas piloto com ponta em carboneto para mandris



3834-DRL-CT/L

Ø	L	€	Icon 1	Icon 2
6.35 mm	81 mm	16,38	1	3834-DRL-CT
6.35 mm	114 mm	9,14	1	3834-DRL-L

Extensões



3834-EXT

Ø	L	€	Icon 1	Icon 2
11.1 mm	330 mm	20,80	1	3834-EXT-1
8.5 mm	330 mm	20,80	1	3834-EXT-2

Mola ejectora. Mola Ejectora



3834-ES

g	€	Icon 1	Icon 2
10 g	2,14	1	3834-ES

Mola Ejectora



Adaptador arvore



3834-ADP

g	€		
20 g	6,42	1	3834-ADP

		€		
150 mm	14	33,73	1	3940-150-14-ST-10P
150 mm	14	319,99	1	3940-150-14-ST-100P
150 mm	18	7,08	10	3940-150-18-ST-2P
150 mm	18	17,70	5	3940-150-18-ST-5P
150 mm	18	33,73	1	3940-150-18-ST-10P
150 mm	18	319,99	1	3940-150-18-ST-100P
228 mm	14	9,18	5	3940-228-14-ST-2P
228 mm	14	22,95	5	3940-228-14-ST-5P
228 mm	14	43,32	1	3940-228-14-ST-10P
228 mm	14	412,60	1	3940-228-14-ST-100P
228 mm	18	9,18	10	3940-228-18-ST-2P
228 mm	18	22,95	5	3940-228-18-ST-5P
228 mm	18	43,32	1	3940-228-18-ST-10P
228 mm	18	412,60	1	3940-228-18-ST-100P
300 mm	14	11,31	5	3940-300-14-ST-2P
300 mm	14	28,29	5	3940-300-14-ST-5P
300 mm	14	54,01	1	3940-300-14-ST-10P
300 mm	14	513,43	1	3940-300-14-ST-100P
300 mm	18	11,31	10	3940-300-18-ST-2P
300 mm	18	28,29	5	3940-300-18-ST-5P
300 mm	18	54,01	1	3940-300-18-ST-10P
300 mm	18	512,41	1	3940-300-18-ST-100P

Parafusos sobresselentes para mandris



3834-SCREWS

g	€		
9 g	2,67	1	3834-M6X29-SET
9 g	1,67	1	3834-M8X5-SET
9 g	1,77	1	3834-M8X6-SET
9 g	1,88	1	3834-M8X10-SET

Serras Sabre Metal Duro



3940-HM

		€		
150 mm	8/12	7,08	10	3940-150-8/12-ST-2P
150 mm	8/12	17,70	5	3940-150-8/12-ST-5P
150 mm	8/12	33,73	1	3940-150-8/12-ST-10P
150 mm	8/12	319,99	1	3940-150-8/12-ST-100P
228 mm	8/12	9,18	10	3940-228-8/12-ST-2P
228 mm	8/12	22,95	5	3940-228-8/12-ST-5P
228 mm	8/12	43,32	1	3940-228-8/12-ST-10P
228 mm	8/12	412,60	1	3940-228-8/12-ST-100P
150 mm	10	8,01	10	3940-150-10-HST-2P
150 mm	10	20,04	5	3940-150-10-HST-5P
150 mm	10	36,30	1	3940-150-10-HST-10P
150 mm	10	319,99	1	3940-150-10-ST-100P
150 mm	10	7,08	10	3940-150-10-ST-2P
150 mm	10	17,70	5	3940-150-10-ST-5P
150 mm	10	33,73	1	3940-150-10-ST-10P
150 mm	14	8,13	10	3940-150-14-HST-2P
150 mm	14	20,33	5	3940-150-14-HST-5P
150 mm	14	36,70	1	3940-150-14-HST-10P
150 mm	18	8,13	10	3940-150-18-HST-2P
150 mm	18	20,33	5	3940-150-18-HST-5P
150 mm	18	36,70	1	3940-150-18-HST-10P
228 mm	10	9,18	10	3940-228-10-HST-2P
228 mm	10	24,98	5	3940-228-10-HST-5P
228 mm	10	46,04	1	3940-228-10-HST-10P
228 mm	10	625,49	1	3940-228-10-HST-100P
228 mm	10	12,78	10	3940-228-10-ST-2P
228 mm	10	22,95	5	3940-228-10-ST-5P
228 mm	10	43,32	1	3940-228-10-ST-10P
228 mm	10	412,60	1	3940-228-10-ST-100P

LÂMINAS PARA SERRAS SABRE

Serras Sabre metal



3940-M

		€		
100 mm	14	5,39	10	3940-100-14-ST-2P
100 mm	14	13,46	5	3940-100-14-ST-5P
100 mm	14	25,73	1	3940-100-14-ST-10P
100 mm	18	5,39	10	3940-100-18-ST-2P
100 mm	18	13,46	5	3940-100-18-ST-5P
100 mm	18	25,73	1	3940-100-18-ST-10P
150 mm	14	7,08	5	3940-150-14-ST-2P
150 mm	14	17,70	5	3940-150-14-ST-5P

		€		
228 mm	14	10,23	10	3940-228-14-HST-2P
228 mm	14	25,60	5	3940-228-14-HST-5P
228 mm	14	47,02	1	3940-228-14-HST-10P
228 mm	18	10,08	10	3940-228-18-HST-2P
228 mm	18	25,19	5	3940-228-18-HST-5P
228 mm	18	50,40	1	3940-228-18-HST-10P
300 mm	10	12,13	10	3940-300-10-HST-2P
300 mm	10	30,35	5	3940-300-10-HST-5P
300 mm	10	54,04	1	3940-300-10-HST-10P
300 mm	14	12,18	10	3940-300-14-HST-2P
300 mm	14	30,43	5	3940-300-14-HST-5P
300 mm	14	54,04	1	3940-300-14-HST-10P
300 mm	18	11,97	10	3940-300-18-HST-2P
300 mm	18	29,96	5	3940-300-18-HST-5P
300 mm	18	52,96	1	3940-300-18-HST-10P

Serras Sabre Metal Suave



3940-FM

		€		
100 mm	24	5,39	10	3940-100-24-ST-2P
100 mm	24	13,46	5	3940-100-24-ST-5P
100 mm	24	25,73	1	3940-100-24-ST-10P
150 mm	24	7,08	5	3940-150-24-ST-2P
150 mm	24	17,70	5	3940-150-24-ST-5P
150 mm	24	33,73	1	3940-150-24-ST-10P
150 mm	24	319,99	1	3940-150-24-ST-100P

Serras Sabre Metal Precisão



3940-PM

		€		
100 mm	14	5,39	10	3940-100-14-SC-2P
100 mm	14	13,46	5	3940-100-14-SC-5P
100 mm	18	5,39	10	3940-100-18-SC-2P
100 mm	18	13,46	5	3940-100-18-SC-5P
100 mm	24	5,39	10	3940-100-24-SC-2P
100 mm	24	13,46	5	3940-100-24-SC-5P

Lâminas com ponta de carboneto de tungstênio para serra sabre para o corte de metais pesados



3946-C HM

Comprimento	Quantidade	Preço	Empacotamento	Modelo
300 mm	8	370,80	1	3946-300-8-HST-10P
150 mm	8	22,25	10	3946-150-8-HST-1P
228 mm	8	30,81	10	3946-228-8-HST-1P
300 mm	8	39,82	10	3946-300-8-HST-1P

10P = 10 peças

Lâminas com ponta de carboneto de tungstênio para serra sabre para o corte de aço inoxidável



3946-C SS

Comprimento	Quantidade	Preço	Empacotamento	Modelo
150 mm	10	9,13	10	3946-150-10-HST-1P
228 mm	10	35,38	10	3946-228-10-HST-1P
300 mm	10	47,92	10	3946-300-10-HST-1P

Lâminas de grão de diamante de serra Sabre para ferro fundido e cerâmica



3946-D CI

Comprimento	Quantidade	Preço	Empacotamento	Modelo
100 mm	Grit	9,13	10	3946-100-DG-ST-2P
150 mm	Grit	15,97	10	3946-150-DG-ST-2P

Folha de serrote para reparação de automóveis. SANDFLEX Bi-metal



3845

Comprimento	Quantidade	Preço	Empacotamento	Modelo
91.5 mm	18	40,61	1	3845-18-10P
91.5 mm	24	40,61	1	3845-24-10P
90 mm	32	40,61	1	3845-32-10P

SANDFLEX Bi-metal

Serras Sabre para Madeira & Metal



3940-WM

Comprimento	Quantidade	Preço	Empacotamento	Modelo
150 mm	4/6	9,27	10	3940-150-4/6-SC-2P
150 mm	4/6	17,70	5	3940-150-4/6-SC-5P
150 mm	4/6	33,73	1	3940-150-4/6-SC-10P
150 mm	5/8	9,27	10	3940-150-5/8-SL-2P
150 mm	5/8	17,70	5	3940-150-5/8-SL-5P
150 mm	5/8	33,73	1	3940-150-5/8-SL-10P
150 mm	5/8	319,99	1	3940-150-5/8-SL-100P
150 mm	6	9,27	10	3940-150-6-ST-2P
150 mm	6	17,70	5	3940-150-6-ST-5P
150 mm	6	33,73	1	3940-150-6-ST-10P
228 mm	6	10,73	10	3940-228-6-SL-2P
228 mm	6	22,95	5	3940-228-6-SL-5P
228 mm	6	43,32	1	3940-228-6-SL-10P
300 mm	6	10,73	10	3940-300-6-SL-2P
300 mm	6	28,29	5	3940-300-6-SL-5P
300 mm	6	54,01	1	3940-300-6-SL-10P
300 mm	8/12	10,73	5	3940-300-8/12-SL-2P
300 mm	8/12	28,29	5	3940-300-8/12-SL-5P
300 mm	8/12	54,01	1	3940-300-8/12-SL-10P
300 mm	8/12	502,13	1	3940-300-8/12-SL-100P

Serras Sabre Fogo & Resgate



3940-FR

Comprimento	Quantidade	Preço	Empacotamento	Modelo
228 mm	10	13,52	10	3940-228-10-DSL-2P
228 mm	10	33,78	5	3940-228-10-DSL-5P
228 mm	10	60,94	1	3940-228-10-DSL-10P
228 mm	10	609,48	1	3940-228-10-DSL-100P

Serras Sabre Demolição



3940-D

Comprimento	Quantidade	Preço	Empacotamento	Modelo
150 mm	5/8	10,73	5	3940-150-5/8-DSL-2P
150 mm	5/8	18,54	5	3940-150-5/8-DSL-5P
150 mm	5/8	35,30	1	3940-150-5/8-DSL-10P
228 mm	5/8	10,73	10	3940-228-5/8-DSL-2P
228 mm	5/8	23,87	5	3940-228-5/8-DSL-5P
228 mm	5/8	45,68	1	3940-228-5/8-DSL-10P
300 mm	5/8	11,91	10	3940-300-5/8-DSL-2P
300 mm	5/8	29,73	5	3940-300-5/8-DSL-5P
300 mm	5/8	56,69	1	3940-300-5/8-DSL-10P

Serras Sabre para Paletes



3940-PR

Comprimento	Quantidade	Preço	Empacotamento	Modelo
228 mm	10/14	42,90	1	3940-228-10/14-PR13-10P
228 mm	10/14	31,19	1	3940-228-10/14-PR09-10P
228 mm	10/14	311,77	1	3940-228-10/14-PR09-100P
228 mm	10/14	429,06	1	3940-228-10/14-PR13-100P
228 mm	8/12	396,67	1	3940-228-8/12-PR13-100P
228 mm	10	414,29	1	3940-228-10-PR09-100P



Lâminas com ponta de carboneto de tungstênio para serra sabre para o corte de madeira e pregos



3946-C_WM

Comprimento	Quantidade	Preço	Unidades	Modelo
150 mm	6	9,13	10	3946-150-6-DSL-1P
228 mm	6	28,24	10	3946-228-6-DSL-1P
300 mm	6	31,95	10	3946-300-6-DSL-1P

Lâminas HCS para serra sabre para madeira e plástico



3942-WP

Comprimento	Quantidade	Preço	Unidades	Modelo
228 mm	11	8,74	10	3942-228-11-HSL-2P
228 mm	11	18,44	5	3942-228-11-HSL-5P
228 mm	11	30,84	1	3942-228-11-HSL-10P

Lâmina de serra curva recíproca para corte médio



3943-C30-JT-M

Comprimento	Comprimento	Preço	Unidades	Modelo
323 mm	13 in	19,12	10	3943-C30-JT-M
373 mm	15 in	21,37	10	3943-C35-JT-M

Lâminas HCS para serra sabre para madeira



3942-W

Comprimento	Quantidade	Preço	Unidades	Modelo
228 mm	7	12,05	10	3942-228-7-HSL-2P
228 mm	7	23,46	5	3942-228-7-HSL-5P
228 mm	7	43,32	1	3942-228-7-HSL-10P
300 mm	7	20,17	10	3942-300-7-HSL-2P
300 mm	7	26,64	5	3942-300-7-HSL-5P
300 mm	7	49,61	1	3942-300-7-HSL-10P

Lâminas para serras sabre de bimetálico Sandflex® para argamassa e tábuas



3942-PB

Comprimento	Quantidade	Preço	Unidades	Modelo
150 mm	7	19,24	10	3942-150-7-SL-2P
150 mm	7	19,24	5	3942-150-7-SL-5P
150 mm	7	35,80	1	3942-150-7-SL-10P
228 mm	7	9,31	10	3942-228-7-SL-2P
228 mm	7	23,27	5	3942-228-7-SL-5P
228 mm	7	43,52	1	3942-228-7-SL-10P
300 mm	7	14,54	10	3942-300-7-SL-2P
300 mm	7	27,94	5	3942-300-7-SL-5P
300 mm	7	48,20	1	3942-300-7-SL-10P

Lâmina de serra curva longa recíproca para corte grosseiro



3943-C35-JT-C

Comprimento	Comprimento	Preço	Unidades	Modelo
373 mm	15 in	20,70	10	3943-C35-JT-C

Lâminas HCS para serra sabre para madeira grosseira



3942-CW

Comprimento	Quantidade	Preço	Unidades	Modelo
228 mm	5	12,26	10	3942-228-5-HSL-2P
228 mm	5	25,00	5	3942-228-5-HSL-5P
228 mm	5	46,05	1	3942-228-5-HSL-10P
300 mm	5	15,26	10	3942-300-5-HSL-2P
300 mm	5	29,71	5	3942-300-5-HSL-5P
300 mm	5	51,73	1	3942-300-5-HSL-10P

Lâmina de serra curva recíproca para corte fino



3943-C30-JT-F

Comprimento	Comprimento	Preço	Unidades	Modelo
323 mm	13 in	19,12	10	3943-C30-JT-F

Lâmina de serra reta recíproca para corte fino



3943-S20-JT-F

Comprimento	Comprimento	Preço	Unidades	Modelo
228 mm	9 in	15,75	10	3943-S20-JT-F

Lâmina de serra reta recíproca para corte grosso



3943-R28-UT-C-2P

		€		
300 mm	12 in	16,87	10	3943-R28-UT-C-2P

Conjunto de lâminas para serra sabre em bimetálico Sandflex® para metais pesados e demolição - 5 peças



3940-HDD-SET-5P

		€		
5	222 g	33,52	5	3940-HDD-SET-5P

3940-150-5/8-DSL, 3940-228-5/8-DSL, 3940-228-10-DSL, 3940-150-14-HST, 3940-228-14-HST, 3940-150-5/8-DSL, 3940-228-5/8-DSL, 3940-228-10-DSL, 3940-150-14-HST, 3940-228-14-HST

Conjunto de lâminas de serra sabre para madeira e metal - 12 peças



3940-MIX-SET-12P

		€		
12	480 g	54,04	6	3940-MIX-SET-12P

Conjunto de lâminas para serra sabre em bimetálico Sandflex® para metais - 5 peças



3940-METAL-SET-5P

		€		
5	125 g	22,00	5	3940-METAL-SET-5P

3940-150-14-ST, 3940-150-18-ST, 3940-150-24-ST, 3940-228-18-ST, 3940-228-14-ST

Conjunto de lâminas de serra sabre para madeira e metal - 5 peças



3940-MIX-SET-5P

		€		
5	150 g	25,13	5	3940-MIX-SET-5P

3940-100-24-SC, 3940-150-18-ST, 3940-150-14-ST, 3940-228-6-SL, 3942-228-7-HSL, 3940-100-24-SC, 3940-150-18-ST, 3940-150-14-ST, 3940-228-6-SL, 3942-228-7-HSL

Conjunto de lâminas de serra sabre para madeira - 5 peças



3942-WOOD-SET-5P

		€		
5	191 g	29,33	5	3942-WOOD-SET-5P

3940-228-6-SL, 3942-228-11-HSL, 2x 3942-228-7-HSL, 3942-150-7-SL, 3940-228-6-SL, 3942-228-11-HSL, 2x 3942-228-7-HSL, 3942-150-7-SL

Conjunto de lâminas para serra sabre em bimetálico Sandflex® para metais - 12 peças



3940-METAL-SET-12P

		€		
12	460 g	52,80	6	3940-METAL-SET-12P

Conjunto de lâminas para serra sabre para madeira com argamassa e metal - 10 peças



3940-MIX-SET-10P

		€		
10	245 g	45,04	4	3940-MIX-SET-10P

3940-100-24-SC, 3940-100-18-SC, 3940-150-24-ST, 3940-150-18-ST, 3940-150-14-ST, 3940-150-10-ST, 3940-228-6-SL, 3942-228-11-HSL, 3942-228-7-HSL, 3942-150-7-SL, 3940-100-24-SC, 3940-100-18-SC, 3940-150-24-ST, 3940-150-18-ST, 3940-150-14-ST, 3940-150-10-ST, 3940-228-6-SL, 3942-228-11-HSL, 3942-228-7-HSL, 3942-150-7-SL

Conjunto de lâminas de serra sabre para madeira - 12 peças



3942-WOOD-SET-12P

		€		
12	525 g	70,40	6	3942-WOOD-SET-12P



Lâminas em aço inoxidável para serra sabre para carne e gelo



3944

L	T	€	Q	Ref
300 mm	4	11,43	10	3944-300-3-MEAT-1P

Lâminas com ponta de carboneto de tungstênio para serra sabre para o corte de materiais de pedra



3946-CT

L	T	€	Q	Ref
150 mm	6	24,50	5	3946-150-6-SL-1P
228 mm	3	23,87	5	3946-228-3-ST-1P

Lâminas com ponta de carboneto de tungstênio para serra sabre para o corte de tijolos, LECA e betão areado



3946-C_B

L	T	€	Q	Ref
300 mm	2	34,23	10	3946-300-2-CB-1P
457 mm	2	45,64	10	3946-457-2-CB-1P

LÂMINAS TICO-TICO

Haste EURO, Aço carbono. apropriado para metal



91-M

L	T	€	Q	Ref
100 mm	15/23	8,50	1	91-3PM-5P
100 mm	8	13,03	1	91-433-5P
77 mm	36	7,21	1	91-502-5P

L	T	€	Q	Ref
77 mm	21	8,84	1	91-512-5P
77 mm	21	35,13	1	91-512-25P
77 mm	21	7,95	1	91-517-5P
77 mm	13	7,46	1	91-522-5P
132 mm	25	9,61	1	91-611-5P
77 mm	21	7,77	1	91-612-5P
77 mm	13	9,02	1	91-622-5P
132 mm	14	16,53	1	91-7V1-5P

apropriado para metal

Haste EURO, Aço carbono. apropriado para metal e madeira



91-WM

L	T	€	Q	Ref
132 mm	10/14	13,30	1	91-4PWM-5P
100 mm	10/14	13,52	1	91-623-5P

apropriado para metal e madeira

Tipo EURO. Aço carbono, para materiais acios



91-W

L	T	€	Q	Ref
117 mm	10	10,51	1	91-2PW-5P
132 mm	8	17,87	1	91-434-5P
105 mm	6	19,10	1	91-444-5P
100 mm	8	4,41	1	91-023-5P
77 mm	12	5,79	1	91-027-5P
100 mm	6	6,10	1	91-143-5P
100 mm	6	27,85	1	91-143-25P
100 mm	6	111,52	1	91-143-100P
100 mm	6	7,15	1	91-148-5P
100 mm	10	6,42	1	91-223-5P
100 mm	10	8,99	1	91-226-5P
132 mm	6	8,68	1	91-233-5P
100 mm	6	7,21	1	91-243-5P
77 mm	19	13,52	1	91-412-5P
100 mm	6	18,67	1	91-443-5P

Aço carbono, para materiais acios

Conjunto de lâminas para serra tico-tico para metal, 10 peças



91-METAL-10P

Q	€	Q	Ref
10	18,82	1	91-METAL-10P

x3 91-512 (T118A), x3 91-522 (T118B), x1 91-433 (T127DF), x1 91-502 (T118G), x2 91-4PWM (T111HF)

Conjunto de lâminas para serra tico-tico para madeira e plástico, 10 peças



91-WOOD-10P

Q	€	Q	Ref
10	16,42	1	91-WOOD-10P

x4 91-143 (T144D), x2 91-223 (T101B), x2 91-023 (T111C), x1 91-148 (T244D), x1 91-226 (T101BR)

Conjunto de lâminas para serra tico-tico para madeira e metal, 10 peças



91-MIXED-10P

Q	€	Q	Ref
10	18,02	1	91-MIXED-10P

x3 91-143 (T144D), x1 91-223 (T101B), x1 91-148 (T244D), x2 91-512 (T118A), x2 91-522 (T118B), x1 91-623 (T111HF)

ACESSÓRIOS MULTI-FERRAMENTAS

Lâmina padrão curva multiferramenta para corte de madeira



92-S_W

			€		
1		35 x 50 x 97 mm	18,26	70	92-133-1P
3		35 x 50 x 97 mm	47,92	46	92-133-3P

Lâmina padrão multiferramenta para corte de madeira com precisão



92-P_W

			€		
1		30 x 50 x 97 mm	20,54	70	92-205-1P
3		30 x 50 x 97 mm	58,53	46	92-205-3P
1		65 x 50 x 97 mm	17,12	70	92-229-1P

Lâmina padrão curva multiferramenta para corte de madeira



92-C_W

			€		
1		65 x 50 x 97 mm	15,40	70	92-225-1P

Lâmina padrão multiferramenta para madeira universal com corte de pregos



92-U_WN

			€		
1		35 x 50 x 97 mm	17,12	70	92-160-1P
3		35 x 50 x 97 mm	52,49	46	92-160-3P

Lâmina padrão de grande durabilidade multiferramenta para madeira com corte de pregos



92-LF_WN

			€		
1		50 x 50 x 97 mm	18,26	70	92-221-1P
1		65 x 50 x 97 mm	17,12	70	92-228-1P

Lâmina padrão multiferramenta para madeira universal com corte de metal



92-U_WM

			€		
1		28 x 55 x 100 mm	18,83	70	92-222-1P
3		28 x 55 x 100 mm	53,66	46	92-222-3P
1		44 x 55 x 100 mm	19,40	70	92-223-1P
3		44 x 55 x 100 mm	51,91	46	92-223-3P

Lâmina com ponta de carboneto de multiferramentas com revestimento de estanho para corte de metal



92-C_M

			€		
1		35 x 42 x 82 mm	29,67	70	92-236-1P

Lâmina padrão multiferramenta para corte fino em metal



92-FM

			€		
1		30 x 50 x 97 mm	14,84	70	92-157-1P

Lâmina segmentada multiferramenta para corte de metal



92-M_S

			€		
1		85 mm	26,15	90	92-106-1P



Lâmina segmentada multiferramenta para corte de madeira



92-SP

1 85 mm 23,61 90 92-113-1P

Lâmina segmentada multiferramenta para ranhuras e retoques



92-CG_S

1 75 mm 46,52 90 92-118-1P

Faca padrão multiferramenta para materiais macios



92-MFK

1 41 x 42 x 87 mm 25,36 70 92-251-1P

Lâmina circular multiferramenta para corte de metal



92-M_R

115 85 mm 46,52 90 92-174-1P

Lâmina segmentada multiferramenta para mármore e epóxi



92-DG_S

1 90 mm 78,90 50 92-166-1P

Lâminas raspadoras padrão multiferramenta



92-SC

1 52 x 38 x 83 mm 10,56 90 92-165-1P
1 50 x 38 x 83 mm 19,69 90 92-226-1P

Conjunto de lâminas padrão multiferramenta para corte de madeira e metal - 8 pcs



92-Universal_WM_Set

8 32 x 160 x 195 mm 119,92 34 92-WM-SET-8P

Multiferramenta de formato triangular para raspar e retocar



92-CR_T

1 80 mm 32,38 90 92-001-1P

Lâmina de corte em forma de cogumelo multiferramenta



92-CM

1 70 x 30 x 75 mm 30,64 90 92-245-1P

92-222-1Px 2, 92-223-1Px 2

92-228-1Px 2

92-160-1Px 2

BAHCO

Lixas triangulares multiferramentas



92-Sanding

X	Δ	€		
1	80 mm	29,67	20	92-136-1P
5	82 mm	3,99	10	92-136-G40-5P
5	82 mm	3,99	10	92-136-G80-5P
5	82 mm	3,99	10	92-136-G120-5P
5	82 mm	3,99	10	92-136-G240-5P
1	93 mm	12,29	50	92-137-1P
5	94 mm	3,99	10	92-137-G40-5P
5	94 mm	3,99	10	92-137-G80-5P
5	94 mm	3,99	10	92-137-G120-5P
5	94 mm	3,99	10	92-137-G240-5P

LÂMINAS PARA SERRAS CIRCULARES

Lâminas para serra circular para serras sem fios em madeira



8501-C

Ø	Curve	€		
136 mm	24	22,18	1	8501-136-10-24C
136 mm	24	24,65	1	8501-136-20-24C
150 mm	24	27,11	1	8501-150-10-24C
160 mm	24	28,35	1	8501-160-20-24C
165 mm	24	28,35	1	8501-165-20-24C
184 mm	24	30,81	1	8501-184-20-24C
190 mm	24	36,97	1	8501-190-30-24C

Lâminas para serra circular para serras portáteis/de mesa em madeira



8501-P/T

Ø	Curve	€		
125 mm	16	25,52	1	8501-2
130 mm	16	24,84	1	8501-3
140 mm	16	25,64	1	8501-4
140 mm	24	26,89	1	8501-4F
140 mm	30	28,29	1	8501-4XF
150 mm	18	29,75	1	8501-5
150 mm	30	31,99	1	8501-5F
160 mm	18	29,47	1	8501-7
160 mm	30	31,53	1	8501-7F
170 mm	18	31,99	1	8501-10
170 mm	30	34,26	1	8501-10F
180 mm	20	33,48	1	8501-12
180 mm	40	39,39	1	8501-12F
184 mm	24	36,49	1	8501-13
184 mm	40	38,83	1	8501-13F
184 mm	24	32,03	1	8501-184-16-24
184 mm	40	33,88	1	8501-184-16-40
190 mm	20	38,47	1	8501-15
190 mm	40	42,09	1	8501-15F
190 mm	60	40,05	1	8501-190-30-60XF
200 mm	20	46,93	1	8501-16
200 mm	40	51,30	1	8501-16F
210 mm	20	46,67	1	8501-17
210 mm	40	53,07	1	8501-17F
210 mm	60	46,83	1	8501-210-30-60XF
230 mm	20	47,48	1	8501-22
230 mm	40	54,70	1	8501-22F
230 mm	60	51,75	1	8501-230-30-60XF
235 mm	30	48,02	1	8501-23
235 mm	40	55,39	1	8501-23F
235 mm	60	52,98	1	8501-235-30-60XF
250 mm	24	60,97	1	8501-28
250 mm	40	63,51	1	8501-28F
250 mm	60	70,27	1	8501-28XF

Lâminas para serra circular para serras de imersão em madeira



8501-P

Ø	Curve	€		
160 mm	48	28,35	1	8501-160-20-48XF
165 mm	48	29,58	1	8501-165-20-48XF

Lâminas para serra circular para serras de esquadria em madeira



8501-M

Ø	Curve	€		
210 mm	48	78,86	1	8501-210-30-48SW
216 mm	24	49,45	1	8501-16SW
216 mm	48	52,72	1	8501-18SW
216 mm	60	54,70	1	8501-216-60SW
250 mm	60	70,20	1	8501-28SW
260 mm	24	72,48	1	8501-260-24SW
260 mm	40	67,78	1	8501-260-40SW
260 mm	60	71,48	1	8501-260-60SW
300 mm	60	91,42	1	8501-30SW
305 mm	40	41,78	1	8501-305-30-40SW
305 mm	60	45,60	1	8501-305-30-60SW

Lâminas para serra circular para serras de uso em locais de construção em madeira



8501-S

Ø	Curve	€		
300 mm	30	80,24	1	8501-30
300 mm	40	82,59	1	8501-30F
300 mm	60	91,15	1	8501-30XF
315 mm	30	82,27	1	8501-31
315 mm	40	90,79	1	8501-31F
400 mm	40	108,31	1	8501-40



Lâminas para serra circular para serras de esquadria em alumínio e plástico



8501-AP

Ø	mm	€	Qtd	Ref
210 mm	48	52,94	1	8501-17S
216 mm	48	56,21	1	8501-18S
250 mm	80	83,97	1	8501-28S
260 mm	80	80,10	1	8501-260-30-80S
300 mm	96	108,12	1	8501-30S
305 mm	96	53,73	1	8501-305-30-96S

DISCOS ABRASIVOS PARA CORTE

Discos Abrasivos de Elevada Performance para Corte Multifunções & Metal



391-T41_IM

Ø	mm	€	Qtd	Ref
		2,56	50	3911-2301922XDT
		2,44	50	3911-2302522XDT
		1,12	10	3911-751010XTM
115x1.6 mm		0,93	50	3911-115-T41-IM
115x1.0 mm		0,93	50	3911-115T41-IM
125x1.6 mm		1,13	50	3911-125-T41-IM
180x2.0 mm		2,16	50	3911-180-T41-IM
230x2.5 mm		3,08	50	3911-230-T41-IM
115x1.0 mm		0,82	25	3912-115-T41-IM
125x1.0 mm		0,88	25	3912-125-T41-IM
125x1.0 mm		0,98	25	3911-125T41-IM
180x1.6 mm		1,69	50	3911-180T41-IM
230x1.9 mm		2,33	50	3911-230T41-IM
230x3.0 mm		2,78	50	3911-230T41-IM
115x1 mm		12,01	10	3911-115-IM-10P
125x1 mm		12,50	10	3911-125-IM-10P

Discos de corte de alto desempenho abrasivos para alumínio



391-T41_ALU

Ø	mm	€	Qtd	Ref
115 mm	22.23 mm	0,98	25	3911-115-T41-AL
125 mm	22.23 mm	0,98	25	3911-125-T41-AL

Discos Abrasivos de Elevada Performance para Corte de Inox



391-T41-I

Ø	mm	€	Qtd	Ref
115x1.0 mm		0,98	25	3911-115-T41-I
125x1.0 mm		1,13	25	3911-125-T41-I
150x1.0 mm		2,05	50	3911-150-T41-I
180x1.6 mm		2,42	50	3911-180-T41-I
230x1.9 mm		3,08	50	3911-230-T41-I

Discos de corte de alto desempenho abrasivos para aço inoxidável e metal



391-T41_CS

Ø	mm	€	Qtd	Ref
356 mm	25.4 mm	5,67	35	3911-350-X2TM
400 mm	25.4 mm	11,69	15	3911-400-F2TM
400 mm	25.4 mm	12,25	15	3911-400-X2TM

Discos Abrasivos de Elevada Performance para Corte de Metal



391-T42_M

Ø	mm	€	Qtd	Ref
115x2.5 mm		0,88	25	3911-115-T42-M
125x2.5 mm		0,98	25	3911-125-T42-M
150x2.5 mm		1,65	25	3911-150-T42-M
180x3.2 mm		2,16	25	3911-180-T42-M
230x3.2 mm		3,08	50	3911-230-T42-M

Discos Abrasivos de Elevada Performance para Corte de Construção e Pedra



391-T42_ST

Ø	mm	€	Qtd	Ref
115x3.2 mm		1,03	25	3912-115-T42-ST
125x3.2 mm		1,24	25	3912-125-T42-ST
180x3.2 mm		1,34	25	3912-180-T42-ST
230x3.2 mm		2,16	50	3912-230-T42-ST

Discos Abrasivos de Elevada Performance para desbaste de Inox & Metal



392-T27_IM

Ø	mm	€	Qtd	Ref
115x6.4 mm		1,39	25	3921-115-T27-IM
125x6.4 mm		1,75	25	3921-125-T27-IM
150x6.4 mm		2,42	25	3921-150-T27-IM
180x6.5 mm		2,78	25	3921-180-T27-IM
230x6.5 mm		4,22	25	3921-230-T27-IM

Discos Abrasivos cónicos para desbaste de Inox & Metal



392-FLAP_C

Ø	€		
115 mm	3,30	20	3926-115IM-C40
115 mm	3,30	20	3926-115IM-C60
115 mm	3,30	20	3926-115IM-C80
115 mm	3,30	20	3926-115IM-C120
125 mm	3,91	20	3926-125IM-C40
125 mm	3,91	20	3926-125IM-C60
125 mm	3,91	20	3926-125IM-C80
125 mm	3,91	20	3926-125IM-C120

Discos Abrasivos para desbaste de Inox & Metal



392-FLAP_P

Ø	€		
115 mm	2,27	20	3927-115IM-P40
115 mm	2,27	20	3927-115IM-P60
115 mm	2,27	20	3927-115IM-P80
115 mm	2,27	20	3927-115IM-P120
125 mm	2,63	20	3927-125IM-P40
125 mm	2,63	20	3927-125IM-P60
125 mm	2,63	20	3927-125IM-P80
125 mm	2,63	20	3927-125IM-P120
125 mm	8,06	12	3927-125-40-3P
125 mm	8,06	12	3927-125-60-3P
125 mm	8,06	12	3927-125-80-3P
125 mm	8,06	12	3927-125-120-3P

Discos Abrasivos Diamantados para Corte de Cerâmica & Azulejos



391-DIAM_C

Ø	€		
115 mm	17,00	100	3916-115-10P-CE
125 mm	21,01	100	3916-125-10P-CE
115 mm	6,49	100	3917-115-7S-C
125 mm	8,14	100	3917-125-7S-C

Discos Abrasivos Diamantados para Corte Multifunções de Pedra



391-DIAM_U

Ø	€		
115 mm	11,64	100	3916-115-10S-UE
125 mm	14,32	100	3916-125-10S-UE
150 mm	17,05	50	3916-150-10S-UE
180 mm	18,08	50	3916-180-10S-UE
230 mm	25,39	25	3916-230-10S-UE
115 mm	6,28	100	3917-115-7S-U
125 mm	8,34	100	3917-125-7S-U
230 mm	18,54	25	3917-230-7S-U

Discos Abrasivos Diamantados para Corte de Betão Reforçado



391-DIAM_RC

Ø	€		
230 mm	45,01	25	3916-230-10L-RC

LÂMINAS DE SERRA DE FITA

Fita de serra portátil EASY CUT



3857 Easy-Cut Portaband

		€		
S	EZ	27,79	1	3857-13-0-6-EZ-S-3P690
S	EZ	27,79	1	3857-13-0-6-EZ-S-3P730
S	EZ	27,79	1	3857-13-0-6-EZ-S-3P835
S	EZ	27,79	1	3857-13-0-6-EZ-S-3P900
M	EZ	27,79	1	3857-13-0-6-EZ-M-3P690
M	EZ	27,79	1	3857-13-0-6-EZ-M-3P730
M	EZ	27,79	1	3857-13-0-6-EZ-M-3P835
M	EZ	27,79	1	3857-13-0-6-EZ-M-3P900
M	EZ	27,79	1	3857-13-0-6-EZ-M-3P1140



LIMAS ROTATIVAS "CARBIDE"

Limas rotativas de carboneto de tungstênio, cilíndrica.

F=Fina, M=Média, C=Grosso



A

Ø	Grading	€	Icons
3 mm	Medium	14,52	1 A0313M03
3 mm	Medium	17,63	1 A0313M03E
3 mm	Medium	15,12	1 A0313M03X
3 mm	Medium	17,65	1 A0313M03XE
3 mm	Medium	22,62	1 A0313M03XE-60
3 mm	Medium	22,97	1 A0313M03XE-80
6.3 mm	Medium	26,41	1 A0613M03X
6 mm	Medium	25,21	1 A0616M06
6 mm	Medium	28,83	1 A0616M06E
6 mm	Medium	27,65	1 A0616M06X
6 mm	Medium	28,83	1 A0616M06XE
8 mm	Medium	36,89	1 A0820M06
8 mm	Medium	42,74	1 A0820M06E
8 mm	Medium	39,31	1 A0820M06X
8 mm	Medium	45,10	1 A0820M06XE
10 mm	Medium	42,34	1 A1020M06
10 mm	Medium	48,79	1 A1020M06E
9.6 mm	Medium	44,35	1 A1020M06X
9.6 mm	Medium	48,79	1 A1020M06XE
12 mm	Medium	53,04	1 A1225M06
12.7 mm	Medium	61,08	1 A1225M06E
12 mm	Medium	59,14	1 A1225M06X
12.7 mm	Medium	55,95	1 A1225M08
12.7 mm	Medium	61,08	1 A1225M08E
12.7 mm	Medium	56,05	1 A1225M08X
12.7 mm	Medium	64,32	1 A1225M08XE
16 mm	Medium	66,52	1 A1625M06
16 mm	Medium	69,95	1 A1625M06X
16 mm	Medium	80,46	1 A1625M06XE
16 mm	Medium	66,52	1 A1625M08
16 mm	Medium	80,45	1 A1625M08E
16 mm	Medium	69,95	1 A1625M08X
16 mm	Medium	76,42	1 A1625M08XE

F=Fina, M=Média, C=Grosso

Limas rotativas de carboneto de tungstênio, ponta redonda cilíndrica.

F=Fina, M=Média, C=Grosso



C

Ø	Grading	€	Icons
3 mm	Medium	14,52	1 C0313M03
3 mm	Medium	15,12	1 C0313M03X
6.3 mm	Medium	30,84	1 C0616M03X
6 mm	Medium	27,83	1 C0616M06
6 mm	Medium	29,23	1 C0616M06X
8 mm	Medium	39,92	1 C0820M06
8 mm	Medium	41,93	1 C0820M06X

Ø	Grading	€	Icons
9.6 mm	Medium	40,73	1 C1020M06
10 mm	Medium	42,74	1 C1020M06X
12 mm	Medium	60,49	1 C1225M06
12 mm	Medium	67,43	1 C1225M06X
12.7 mm	Medium	63,92	1 C1225M08X
16 mm	Medium	74,00	1 C1625M06
16 mm	Medium	77,63	1 C1625M06X
16 mm	Medium	74,00	1 C1625M08
16 mm	Medium	77,63	1 C1625M08X

F=Fina, M=Média, C=Grosso

Lima rotativa em carboneto de tungstênio. Esférica



D

Ø	Grading	€	Icons
3 mm	Medium	18,46	1 D0303M03
3 mm	Medium	19,32	1 D0303M03X
6.3 mm	Medium	29,71	1 D0605M03X
6 mm	Medium	28,23	1 D0606M06
6 mm	Medium	29,71	1 D0606M06X
8 mm	Medium	29,08	1 D0807M06
8 mm	Medium	30,56	1 D0807M06X
9.6 mm	Medium	30,14	1 D1009M06
9.6 mm	Medium	31,61	1 D1009M06X
12.7 mm	Medium	42,02	1 D1211M06
12.7 mm	Medium	44,15	1 D1211M06X
16 mm	Medium	62,24	1 D1614M06
16 mm	Medium	61,97	1 D1614M06X
16 mm	Medium	59,00	1 D1614M08
16 mm	Medium	61,99	1 D1614M08X

Esférica

Limas rotativas de carboneto de tungstênio, oval. F=Fein, M=Mittel, C=Grob



E

Ø	Grading	€	Icons
3 mm	Medium	23,77	1 E0308M03
3 mm	Medium	25,05	1 E0308M03X
6 mm	Medium	40,74	1 E0614M06
8 mm	Medium	46,16	1 E0816M06
8 mm	Medium	45,97	1 E0816M06X
9.6 mm	Medium	48,79	1 E1018M06
9.6 mm	Medium	51,21	1 E1018M06X
12.7 mm	Medium	56,05	1 E1222M06
12.7 mm	Medium	58,88	1 E1222M06X
12.7 mm	Medium	59,01	1 E1222M08
12.7 mm	Medium	61,99	1 E1222M08X
16 mm	Medium	90,33	1 E1625M06

Ø	Grading	€	Icons
16 mm	Medium	99,35	1 E1625M06X
16 mm	Medium	90,33	1 E1625M08
16 mm	Medium	94,76	1 E1625M08X

F=Fein, M=Mittel, C=Grob

Limas rotativas de carboneto de tungstênio, arco em volta da ponta. F= Fin, M= Medium, C= Grov



F

Ø	Grading	€	Icons
3 mm	Medium	14,52	1 F0313M03
3 mm	Medium	15,32	1 F0313M03X
6.3 mm	Medium	31,92	1 F0613M03X
6 mm	Medium	35,69	1 F0618M06
6 mm	Medium	37,51	1 F0618M06X
8 mm	Medium	46,97	1 F0820M06
8 mm	Medium	49,40	1 F0820M06X
9.6 mm	Medium	45,77	1 F1020M06
9.6 mm	Medium	47,99	1 F1020M06X
12.7 mm	Medium	58,07	1 F1225M06
12.7 mm	Medium	60,89	1 F1225M06X
12.7 mm	Medium	58,07	1 F1225M08
12.7 mm	Medium	60,89	1 F1225M08X
16 mm	Medium	88,91	1 F1625M06
16 mm	Medium	88,51	1 F1625M06X
16 mm	Medium	88,73	1 F1625M08

F= Fin, M= Medium, C= Grov

Limas rotativas de carboneto de tungstênio. Arco apontado ponta, * por encomenda



G

Ø	Grading	€	Icons
3 mm	Medium	14,52	1 G0313M03
3 mm	Medium	15,12	1 G0313M03X
6.3 mm	Medium	30,25	1 G0613M03X
6 mm	Medium	31,48	1 G0618M06
6 mm	Medium	31,26	1 G0618M06X
8 mm	Medium	40,32	1 G0820M06
8 mm	Medium	42,34	1 G0820M06X
9.6 mm	Medium	48,79	1 G1020M06
9.6 mm	Medium	51,21	1 G1020M06X
12.7 mm	Medium	57,06	1 G1225M06
12.7 mm	Medium	59,88	1 G1225M06X
12 mm	Medium	60,07	1 G1225M08
12 mm	Medium	59,88	1 G1225M08X
16 mm	Medium	77,22	1 G1625M06
16 mm	Medium	81,05	1 G1625M06X
16 mm	Medium	77,22	1 G1625M08
16 mm	Medium	81,05	1 G1625M08X

Arco apontado ponta, * por encomenda

Limas rotativas de carboneto de tungsténio. chama, * por encomenda



H

Ø	Grain	€	Box	Box
6 mm	Medium	31,84	1	H0613M03X
10 mm	Medium	56,24	1	H1025M06
10 mm	Medium	59,00	1	H1025M06X
12.7 mm	Medium	69,40	1	H1232M06
12.7 mm	Medium	72,80	1	H1232M06X
16 mm	Medium	90,84	1	H1635M06X
16 mm	Medium	86,60	1	H1635M06
16 mm	Medium	86,60	1	H1635M08
16 mm	Medium	95,83	1	H1635M08X

chama, * por encomenda

Limas rotativas de carboneto de tungsténio, cone 60°. F= Fin, M= Medium, C= Grov



J

Ø	Grain	€	Box	Box
6 mm	Medium	36,49	1	J0604M06
9.6 mm	Medium	40,74	1	J1010M06
12.7 mm	Medium	48,13	1	J1212M06
16 mm	Medium	70,52	1	J1616M06
16 mm	Medium	66,85	1	J1616M08

F= Fin, M= Medium, C= Grov

Limas rotativas de carboneto de tungsténio, cone 90°. F= Fin, M= Medium, C= Grov



K

Ø	Grain	€	Box	Box
6 mm	Medium	36,49	1	K0602M06
9.6 mm	Medium	42,99	1	K1008M06
12.7 mm	Medium	45,62	1	K1210M06
16 mm	Medium	62,69	1	K1612M06
16 mm	Medium	59,43	1	K1612M08

F= Fin, M= Medium, C= Grov

Limas rotativas de carboneto de tungsténio, cónica ponta redonda. F= Fin, M= Medium, C= Grov



L

Ø	Grain	€	Box	Box
10 mm	Medium	58,22	1	L1020M06
10 mm	Medium	61,14	1	L1020M06X
12.7 mm	Medium	64,73	1	L1225M06
12.7 mm	Medium	71,65	1	L1225M06X
12.7 mm	Medium	73,22	1	L1230M06
12.7 mm	Medium	72,80	1	L1230M06X
16 mm	Medium	76,59	1	L1630M06
16 mm	Medium	80,38	1	L1630M06X
16 mm	Medium	76,59	1	L1630M08
16 mm	Medium	80,38	1	L1630M08X

F= Fin, M= Medium, C= Grov

Limas rotativas em carboneto de tungsténio. F=Fein, M=Mittel, C=Grov



M

Ø	Grain	€	Box	Box
3 mm	Medium	19,78	1	M0310M03
3 mm	Medium	19,76	1	M0310M03X
6.3 mm	Medium	30,25	1	M0613M03X
6 mm	Medium	34,67	1	M0618M06
6 mm	Medium	34,48	1	M0618M06X
9.5 mm	Medium	41,91	1	M1022M06
9.5 mm	Medium	41,74	1	M1022M06X
12.7 mm	Medium	53,82	1	M1227M06
12.7 mm	Medium	53,63	1	M1227M06X
12.7 mm	Medium	53,71	1	M1227M08
16 mm	Medium	88,91	1	M1630M06
16 mm	Medium	88,51	1	M1630M06X
16 mm	Medium	88,91	1	M1630M08
16 mm	Medium	88,51	1	M1630M08X

F=Fein, M=Mittel, C=Grov

Limas rotativas de carboneto de tungsténio, ponta invertida. F= Fin, M= Medium, C= Grov



N

Ø	Grain	€	Box	Box
3 mm	Medium	19,03	1	N0306M03
3 mm	Medium	20,81	1	N0306M03E
6 mm	Medium	29,71	1	N0607M06
12.7 mm	Medium	47,47	1	N1213M06
12.7 mm	Medium	47,26	1	N1213M06X
16 mm	Medium	62,02	1	N1613M06
16 mm	Medium	61,75	1	N1613M06X
16 mm	Medium	62,02	1	N1613M08

F= Fin, M= Medium, C= Grov

Limas rotativas de carboneto de tungsténio. lima cilíndrica para alumínio



A-AL

Ø	Grain	€	Box	Box
6 mm	AL	34,68	1	A0616AL06E
12.7 mm	AL	63,71	1	A1225AL06E
12.7 mm	AL	63,71	1	A1225AL08E
16 mm	AL	105,39	1	A1625AL08XE

lima cilíndrica para alumínio

Limas rotativas de carboneto de tungsténio. ponta redonda cilíndrica para alumínio



C-AL

Ø	Grain	€	Box	Box
6 mm	AL	33,46	1	C0616AL06
12.7 mm	AL	63,92	1	C1225AL06

ponta redonda cilíndrica para alumínio



Limas rotativas de carboneto de tungsténio. lima para alumínio, esférica



D-AL

Ø	Material	€	Box	Icon
12.7 mm	AL	50,52	1	D1211AL06
12.7 mm	AL	50,52	1	D1211AL08

lima para alumínio, esférica

Limas rotativas de carboneto de tungsténio. limas para alumínio arco em volta da ponta



F-AL

Ø	Material	€	Box	Icon
6 mm	AL	42,74	1	F0618AL06
12.7 mm	AL	58,07	1	F1225AL06
12.7 mm	AL	58,07	1	F1225AL08

limas para alumínio arco em volta da ponta

Limas rotativas de carboneto de tungsténio. limas para alumínio, ponta cónica redonda



L-AL

Ø	Material	€	Box	Icon
12.7 mm	AL	87,76	1	L1230AL06
12.7 mm	AL	87,76	1	L1230AL08

limas para alumínio, ponta cónica redonda

Limas rotativas de carboneto de tungsténio. lima especial para reparação de pneus



A/G

Ø	Material	€	Box	Icon
6 mm	TR	32,07	1	A0625M06X

lima especial para reparação de pneus

Limas rotativas cilíndricas de carboneto de tungsténio para aço de alta liga



A-S

Ø	Material	€	Box	Icon
6 mm	Steel	20,73	5	A0618S06E
9.6 mm	Steel	26,53	5	A1020S06
9.6 mm	Steel	29,18	5	A1020S06E
12.7 mm	Steel	41,43	5	A1225S06
12.7 mm	Steel	45,56	5	A1225S06E

Limas rotativas esféricas de carboneto de tungsténio para aço de alta liga



D-S

Ø	Material	€	Box	Icon
6 mm	Steel	20,17	5	D0606S06
9.6 mm	Steel	24,24	5	D1010S06
12.7 mm	Steel	32,70	5	D1212S06

Limas rotativas de ponta redonda em carboneto de tungsténio para aço de alta liga



F-S

Ø	Material	€	Box	Icon
6 mm	Steel	22,93	5	F0618S06
9.6 mm	Steel	28,91	5	F1020S06
12.7 mm	Steel	42,76	5	F1225S06

Limas rotativas redondas de carboneto de tungsténio para aço de alta liga



C-S

Ø	Material	€	Box	Icon
6 mm	Steel	21,97	5	C0618S06
9.6 mm	Steel	29,56	5	C1020S06
12.7 mm	Steel	46,46	5	C1225S06

Limas rotativas de ponta de carboneto de tungsténio para aço de alta liga



G-S

Ø	Material	€	Box	Icon
9.6 mm	Steel	30,84	5	G1020S06
12.7 mm	Steel	41,95	5	G1225S06

Limas rotativas cónicas de carboneto de tungsténio para aço de alta liga



L-S

Ø	Material	€	QTY	Code
9.6 mm	Steel	36,98	5	L1020S06
12.7 mm	Steel	45,15	5	L1228S06

Limas rotativas esféricas de carboneto de tungsténio para inox



D-I

Ø	Material	€	QTY	Code
3 mm	Inox	13,50	5	D0303I03
6 mm	Inox	22,01	5	D0606I06
9.6 mm	Inox	26,46	5	D1010I06
12.7 mm	Inox	35,69	5	D1212I06

Limas rotativas de ponta de carboneto de tungsténio para inox



G-I

Ø	Material	€	QTY	Code
9.6 mm	Inox	33,66	5	G1020I06
12.7 mm	Inox	45,76	5	G1225I06

Brocas rotativas cilíndricas de carboneto de tungsténio para inox



A-I

Ø	Material	€	QTY	Code
3 mm	Inox	13,50	5	A0314I03
6 mm	Inox	20,57	5	A0618I06
9.6 mm	Inox	28,94	5	A1020I06
12.7 mm	Inox	55,42	5	A1225I06

Limas rotativas ovais de carboneto de tungsténio para inox



E-I

Ø	Material	€	QTY	Code
9.6 mm	Inox	32,23	5	E1015I06
12.7 mm	Inox	47,21	5	E1220I06

Limas rotativas com ponta de carboneto de tungsténio para inox



H-I

Ø	Material	€	QTY	Code
9.6 mm	Inox	57,45	5	H1020I06
12.7 mm	Inox	67,55	5	H1232I06

Limas rotativas cónicas redondas de carboneto de tungsténio para inox



C-I

Ø	Material	€	QTY	Code
3 mm	Inox	13,50	5	C0312I03
6 mm	Inox	23,94	5	C0618I06
9.6 mm	Inox	32,23	5	C1020I06
12.7 mm	Inox	61,23	5	C1225I06

Limas rotativas de ponta redonda de carboneto de tungsténio para inox



F-I

Ø	Material	€	QTY	Code
3 mm	Inox	13,50	5	F0312I03
6 mm	Inox	25,00	5	F0618I06
9.6 mm	Inox	31,55	5	F1020I06
12.7 mm	Inox	46,66	5	F1225I06

Limas rotativas cónicas de carboneto de tungsténio para inox



L-I

Ø	Material	€	QTY	Code
9.6 mm	Inox	40,32	5	L1020I06
12.7 mm	Inox	49,26	5	L1228I06



Limas rotativas de ponta de carboneto de tungsténio para reparação de pneus



TR

Ø	Icon	€	Icon	Icon
3 mm	Tire Repair	22,55	5	TR0325M03X-50
4.5 mm	Tire Repair	41,96	5	TR0636M06X-65
6 mm	Tire Repair	47,14	5	TR0650M06X-80
8 in	Tire Repair	62,06	5	TR0860M08X-110
8 mm	Tire Repair	40,29	5	TR4.530M06X-90

Conjunto de brocas rotativas em carboneto de tungsténio para metal 10 e 12 mm - 5 peças



ST-1-5P

X	g	€	Icon	Icon
5	376 g	200,93	1	RB-SET1-M06X-5P

A1020M06XE	
C1225M06X	
F1225M06X	
G1020M06X	
L1230M06X	

Conjunto de brocas rotativas em carboneto de tungsténio para metal de 10 mm - 5 peças



ST-2-5P

X	g	€	Icon	Icon
5	313 g	159,25	1	RB-SET2-M06X-5P

A1020M06XE	
C1020M06X	
D1009M06X	
F1020M06X	
L1020M06X	

Conjunto de brocas rotativas em carboneto de tungsténio para metal - 10 peças



ST-10P

X	g	€	Icon	Icon
10	542 g	380,50	1	RB-SET-M06X-10P

A1020M06XE, A1225M06X	
C1020M06X, C1225M06X	
D1211M06X	
E1018M06X	
F1225M06X	
G1020M06X, G1225M06X	
L1230M06X	

Conjunto de brocas rotativas em carboneto de tungsténio para alumínio - 5 peças



ALU-5P

X	g	€	Icon	Icon
5	380 g	352,31	1	RB-SET-AL06-5P

A1225AL06E	
C1225AL06	
D1211AL06	
F1225AL06	
L1230AL06	

BROCAS

Brocas Max SDS de 4 lâminas para betão armado



4656

Ø	L	€	Icon	Icon
12.0 mm	340 mm	63,38	1	4656-12-340
12.0 mm	540 mm	74,36	1	4656-12-540
14.0 mm	340 mm	68,08	1	4656-14-340
14.0 mm	540 mm	78,04	1	4656-14-540
15.0 mm	340 mm	78,56	1	4656-15-340
16.0 mm	340 mm	81,18	1	4656-16-340
16.0 mm	540 mm	84,84	1	4656-16-540
16.0 mm	940 mm	157,11	1	4656-16-940
16.0 mm	1320 mm	272,33	1	4656-16-1320
18.0 mm	340 mm	83,28	1	4656-18-340
18.0 mm	540 mm	99,51	1	4656-18-540
18.0 mm	940 mm	151,88	1	4656-18-940
18.0 mm	1320 mm	288,04	1	4656-18-1320
20.0 mm	320 mm	78,56	1	4656-20-320
20.0 mm	520 mm	101,60	1	4656-20-520
20.0 mm	920 mm	144,54	1	4656-20-920
20.0 mm	1320 mm	340,41	1	4656-20-1320
22.0 mm	320 mm	96,36	1	4656-22-320
22.0 mm	520 mm	115,21	1	4656-22-520
22.0 mm	920 mm	157,11	1	4656-22-920
22.0 mm	1320 mm	366,60	1	4656-22-1320
24.0 mm	320 mm	93,23	1	4656-24-320
24.0 mm	520 mm	115,21	1	4656-24-520
25.0 mm	320 mm	102,65	1	4656-25-320
25.0 mm	520 mm	125,69	1	4656-25-520
25.0 mm	920 mm	186,44	1	4656-25-920
25.0 mm	1320 mm	396,98	1	4656-25-1320
26.0 mm	520 mm	125,69	1	4656-26-520
28.0 mm	370 mm	123,59	1	4656-28-370
28.0 mm	570 mm	135,12	1	4656-28-570
28.0 mm	670 mm	170,73	1	4656-28-670
28.0 mm	920 mm	204,25	1	4656-28-920
30.0 mm	370 mm	135,12	1	4656-30-370
30.0 mm	570 mm	144,54	1	4656-30-570
32.0 mm	370 mm	141,41	1	4656-32-370
32.0 mm	570 mm	175,97	1	4656-32-570
32.0 mm	920 mm	239,86	1	4656-32-920
32.0 mm	1320 mm	408,49	1	4656-32-1320
35.0 mm	370 mm	156,07	1	4656-35-370
35.0 mm	570 mm	187,49	1	4656-35-570
35.0 mm	670 mm	219,96	1	4656-35-670
37.0 mm	370 mm	157,11	1	4656-37-370
37.0 mm	570 mm	187,49	1	4656-37-570
37.0 mm	920 mm	282,80	1	4656-37-920
38.0 mm	370 mm	272,33	1	4656-38-370
38.0 mm	570 mm	187,49	1	4656-38-570
40.0 mm	370 mm	183,30	1	4656-40-370
40.0 mm	570 mm	225,20	1	4656-40-570
40.0 mm	920 mm	293,28	1	4656-40-920
40.0 mm	1320 mm	492,29	1	4656-40-1320
45.0 mm	570 mm	303,75	1	4656-45-570
45.0 mm	920 mm	417,92	1	4656-45-920
50.0 mm	570 mm	366,60	1	4656-50-570
52.0 mm	570 mm	429,44	1	4656-52-570

Brocas SDS+ de 4 lâminas para betão armado



4651

Ø	L	€			
5.0 mm	115 mm	7,86	1	4651-5-110	
5.0 mm	110 mm	78,61	1	4651-5-110-10P	
5.0 mm	165 mm	8,80	1	4651-5-160	
5.0 mm	160 mm	87,98	1	4651-5-160-10P	
5.0 mm	265 mm	16,34	1	4651-5-260	
5.5 mm	110 mm	106,84	10	4651-5,5-110-10P	
5.5 mm	160 mm	111,03	1	4651-5,5-160-10P	
5.5 mm	115 mm	10,69	1	4651-5,5-110	
5.5 mm	165 mm	11,11	1	4651-5,5-160	
6.0 mm	115 mm	7,86	1	4651-6-110	
6.0 mm	110 mm	78,61	1	4651-6-110-10P	
6.0 mm	165 mm	8,59	1	4651-6-160	
6.0 mm	160 mm	75,16	1	4651-6-160-10P	
6.0 mm	215 mm	11,64	1	4651-6-210	
6.0 mm	265 mm	13,82	1	4651-6-260	
6.0 mm	315 mm	20,43	1	4651-6-310	
6.5 mm	110 mm	11,09	50	4651-6,5-110	
6.5 mm	165 mm	11,22	1	4651-6,5-160	
6.5 mm	160 mm	111,03	1	4651-6,5-160-10P	
6.5 mm	215 mm	15,09	1	4651-6,5-210	
6.5 mm	265 mm	20,12	1	4651-6,5-260	
6.5 mm	315 mm	24,51	1	4651-6,5-310	
7.0 mm	115 mm	10,59	1	4651-7-110	
7.0 mm	165 mm	11,22	1	4651-7-160	
8.0 mm	115 mm	10,26	1	4651-8-110	
8.0 mm	165 mm	10,37	1	4651-8-160	
8.0 mm	160 mm	103,76	1	4651-8-160-10P	
8.0 mm	215 mm	12,89	1	4651-8-210	
8.0 mm	210 mm	128,89	1	4651-8-210-10P	
8.0 mm	265 mm	14,15	1	4651-8-260	
8.0 mm	315 mm	18,13	1	4651-8-310	
8.0 mm	465 mm	29,96	1	4651-8-460	
10.0 mm	115 mm	11,73	1	4651-10-110	
10.0 mm	165 mm	12,47	1	4651-10-160	
10.0 mm	160 mm	124,71	1	4651-10-160-10P	
10.0 mm	215 mm	14,87	1	4651-10-210	
10.0 mm	210 mm	156,49	1	4651-10-210-10P	
10.0 mm	265 mm	19,27	1	4651-10-260	
10.0 mm	315 mm	24,51	1	4651-10-310	
10.0 mm	455 mm	33,52	1	4651-10-450	
10.0 mm	600 mm	42,73	1	4651-10-600	
10.0 mm	1000 mm	100,34	1	4651-10-1000	
12.0 mm	160 mm	15,62	1	4651-12-160	
12.0 mm	160 mm	156,13	1	4651-12-160-10P	
12.0 mm	210 mm	18,65	1	4651-12-210	
12.0 mm	210 mm	186,44	1	4651-12-210-10P	
12.0 mm	260 mm	22,53	1	4651-12-260	
12.0 mm	310 mm	29,23	1	4651-12-310	
12.0 mm	450 mm	36,57	1	4651-12-450	
12.0 mm	600 mm	43,90	1	4651-12-600	
12.0 mm	1000 mm	100,76	1	4651-12-1000	
14.0 mm	160 mm	18,02	1	4651-14-160	
14.0 mm	210 mm	24,10	1	4651-14-210	
14.0 mm	260 mm	26,71	1	4651-14-260	
14.0 mm	310 mm	34,47	1	4651-14-310	
14.0 mm	450 mm	43,37	1	4651-14-450	
14.0 mm	600 mm	60,54	1	4651-14-600	
14.0 mm	1000 mm	135,12	1	4651-14-1000	
15.0 mm	160 mm	27,76	1	4651-15-160	
15.0 mm	260 mm	36,14	1	4651-15-260	
15.0 mm	450 mm	46,83	1	4651-15-450	
16.0 mm	160 mm	34,47	1	4651-16-160	
16.0 mm	210 mm	38,65	1	4651-16-210	
16.0 mm	260 mm	44,73	1	4651-16-260	
16.0 mm	310 mm	46,61	1	4651-16-310	
16.0 mm	450 mm	58,55	1	4651-16-450	
16.0 mm	600 mm	78,56	1	4651-16-600	

Ø	L	€			
16.0 mm	1000 mm	160,26	1	4651-16-1000	
18.0 mm	250 mm	59,92	1	4651-18-250	
18.0 mm	450 mm	70,38	1	4651-18-450	
20.0 mm	250 mm	68,08	1	4651-20-250	
20.0 mm	450 mm	80,55	1	4651-20-450	
22.0 mm	250 mm	81,60	1	4651-22-250	
22.0 mm	450 mm	97,10	1	4651-22-450	
24.0 mm	250 mm	82,92	1	4651-24-250	
24.0 mm	450 mm	102,75	1	4651-24-450	
25.0 mm	250 mm	85,19	1	4651-25-250	
25.0 mm	450 mm	104,22	1	4651-25-450	
28.0 mm	250 mm	98,46	1	4651-28-250	
28.0 mm	450 mm	119,41	1	4651-28-450	
30.0 mm	250 mm	125,93	1	4651-30-250	
30.0 mm	450 mm	130,93	1	4651-30-450	
32.0 mm	450 mm	169,69	1	4651-32-450	

Conjunto de brocas para betão armado SDS + 4C - 5 peças



4651-SET-5

X	€			
5	43,75	1	4651-SET-5	

4651-5-110, 4651-6-110, 4651-6-160, 4651-8-160, 4651-10-160

Conjunto de brocas para betão armado SDS + 4C - 7 peças



4651-SET-7

X	€			
7	66,41	1	4651-SET-7	

4651-5-110, 4651-6-110, 4651-8-110, 4651-6-160, 4651-8-160, 4651-10-160, 4651-12-160

Brocas SDS+ de 2 lâminas para cimento



4652

Ø	L	€			
3.0 mm	110 mm	8,38	50	4652-3-110	
3.5 mm	110 mm	8,38	50	4652-3,5-110	
4.0 mm	110 mm	5,76	1	4652-4-110	
4.0 mm	160 mm	6,91	1	4652-4-160	
5.0 mm	110 mm	4,17	1	4652-5-110	
5.0 mm	160 mm	5,45	1	4652-5-160	
5.0 mm	110 mm	41,78	1	4652-5-110-10P	
5.0 mm	160 mm	54,46	1	4652-5-160-10P	
5.0 mm	210 mm	8,59	1	4652-5-210	
5.5 mm	110 mm	4,93	1	4652-5,5-110	
5.5 mm	110 mm	49,29	10	4652-5,5-110-10P	
5.5 mm	160 mm	6,19	1	4652-5,5-160	
5.5 mm	160 mm	61,86	1	4652-5,5-160-10P	
5.5 mm	210 mm	8,38	50	4652-5,5-210	
6.0 mm	110 mm	4,30	1	4652-6-110	
6.0 mm	110 mm	43,01	1	4652-6-110-10P	
6.0 mm	160 mm	5,03	50	4652-6-160	
6.0 mm	160 mm	50,28	1	4652-6-160-10P	
6.0 mm	210 mm	8,17	1	4652-6-210	
6.0 mm	260 mm	10,46	1	4652-6-260	
6.5 mm	110 mm	4,93	1	4652-6,5-110	
6.5 mm	160 mm	5,76	1	4652-6,5-160	
6.5 mm	160 mm	57,67	1	4652-6,5-160-10P	
7.0 mm	110 mm	6,19	1	4652-7-110	
7.0 mm	160 mm	6,61	1	4652-7-160	
8.0 mm	110 mm	5,14	1	4652-8-110	
8.0 mm	160 mm	5,45	1	4652-8-160	
8.0 mm	160 mm	54,46	1	4652-8-160-10P	
8.0 mm	210 mm	7,32	1	4652-8-210	
8.0 mm	210 mm	73,20	1	4652-8-210-10P	
8.0 mm	260 mm	10,37	1	4652-8-260	
8.0 mm	460 mm	21,90	1	4652-8-460	
9.0 mm	160 mm	8,28	1	4652-9-160	
9.0 mm	210 mm	9,01	1	4652-9-210	
10.0 mm	110 mm	6,19	1	4652-10-110	
10.0 mm	160 mm	6,91	1	4652-10-160	
10.0 mm	160 mm	69,13	1	4652-10-160-10P	
10.0 mm	210 mm	8,28	1	4652-10-210	
10.0 mm	210 mm	82,81	1	4652-10-210-10P	
10.0 mm	260 mm	12,15	1	4652-10-260	
10.0 mm	310 mm	14,15	1	4652-10-310	
10.0 mm	450 mm	22,95	1	4652-10-450	
10.0 mm	600 mm	32,06	1	4652-10-600	
11.0 mm	160 mm	9,12	1	4652-11-160	
11.0 mm	260 mm	14,15	1	4652-11-260	
12.0 mm	160 mm	7,32	1	4652-12-160	
12.0 mm	160 mm	73,20	1	4652-12-160-10P	
12.0 mm	210 mm	9,33	1	4652-12-210	
12.0 mm	210 mm	93,28	1	4652-12-210-10P	
12.0 mm	260 mm	13,31	1	4652-12-260	
12.0 mm	310 mm	17,70	1	4652-12-310	



Ø	L	€		
12.0 mm	450 mm	20,85	1	4652-12-450
12.0 mm	600 mm	33,21	1	4652-12-600
12.0 mm	1000 mm	79,30	1	4652-12-1000
13.0 mm	310 mm	17,17	1	4652-13-310
14.0 mm	160 mm	10,06	1	4652-14-160
14.0 mm	210 mm	14,71	1	4652-14-210
14.0 mm	260 mm	17,70	1	4652-14-260
14.0 mm	310 mm	18,65	1	4652-14-310
14.0 mm	450 mm	24,51	1	4652-14-450
14.0 mm	600 mm	36,35	1	4652-14-600
14.0 mm	1000 mm	86,21	1	4652-14-1000
15.0 mm	260 mm	18,33	1	4652-15-260
16.0 mm	210 mm	17,08	1	4652-16-210
16.0 mm	260 mm	18,44	1	4652-16-260
16.0 mm	310 mm	19,69	1	4652-16-310
16.0 mm	450 mm	29,11	1	4652-16-450
16.0 mm	600 mm	39,17	1	4652-16-600
16.0 mm	1000 mm	97,94	1	4652-16-1000
18.0 mm	200 mm	21,90	1	4652-18-200
18.0 mm	300 mm	29,23	1	4652-18-300
18.0 mm	450 mm	33,31	1	4652-18-450
18.0 mm	1000 mm	100,67	1	4652-18-1000
20.0 mm	200 mm	30,49	1	4652-20-200
20.0 mm	300 mm	34,26	1	4652-20-300
20.0 mm	450 mm	43,15	1	4652-20-450
20.0 mm	600 mm	63,90	1	4652-20-600
20.0 mm	1000 mm	101,60	1	4652-20-1000
22.0 mm	250 mm	39,17	1	4652-22-250
22.0 mm	450 mm	54,46	1	4652-22-450
22.0 mm	600 mm	65,26	1	4652-22-600
22.0 mm	1000 mm	102,65	1	4652-22-1000
24.0 mm	250 mm	45,57	1	4652-24-250
24.0 mm	450 mm	59,29	1	4652-24-450
25.0 mm	250 mm	49,44	1	4652-25-250
25.0 mm	450 mm	63,47	1	4652-25-450
25.0 mm	1000 mm	114,17	1	4652-25-1000
26.0 mm	250 mm	61,80	1	4652-26-250
26.0 mm	450 mm	70,18	1	4652-26-450

Conjunto de brocas para betão armado SDS + 2C - 5 peças



4652-SET-5

X	€		
5	18,48	1	4652-SET-5

4652-5-110, 4652-6-110, 4652-6-160, 4652-8-160, 4652-10-160

Conjunto de brocas para betão armado SDS + 2C - 7 peças



4652-SET-7

X	€		
7	28,83	1	4652-SET-7

4652-5-110, 4652-6-110, 4652-8-110, 4652-6-160, 4652-8-160, 4652-10-160, 4652-12-160

Brocas para betão com ponta de carboneto



4641

Ø	L	€		
3.0 mm	60 mm	3,27	1	4641-3-60
4.0 mm	75 mm	3,44	1	4641-4-75
5.0 mm	85 mm	3,60	1	4641-5-85
5.0 mm	150 mm	4,75	1	4641-5-150
5.5 mm	85 mm	3,60	1	4641-5,5-85
6.0 mm	100 mm	3,71	1	4641-6-100
6.0 mm	150 mm	4,93	1	4641-6-150
6.0 mm	400 mm	12,32	1	4641-6-400
6.5 mm	100 mm	3,71	1	4641-6,5-100
7.0 mm	100 mm	4,19	1	4641-7-100
8.0 mm	120 mm	4,86	1	4641-8-120
8.0 mm	200 mm	7,15	1	4641-8-200
8.0 mm	400 mm	13,06	1	4641-8-400
9.0 mm	120 mm	4,86	1	4641-9-120
10.0 mm	120 mm	5,49	1	4641-10-120
10.0 mm	200 mm	8,49	1	4641-10-200
10.0 mm	400 mm	13,95	1	4641-10-400
10.0 mm	600 mm	15,45	1	4641-10-600
11.0 mm	150 mm	6,35	1	4641-11-150
12.0 mm	150 mm	7,46	1	4641-12-150
12.0 mm	200 mm	10,53	1	4641-12-200
12.0 mm	400 mm	14,82	1	4641-12-400
12.0 mm	600 mm	16,81	1	4641-12-600
13.0 mm	150 mm	10,53	1	4641-13-150
14.0 mm	150 mm	12,26	1	4641-14-150
14.0 mm	400 mm	18,20	1	4641-14-400
14.0 mm	600 mm	20,39	1	4641-14-600
16.0 mm	150 mm	13,55	1	4641-16-150
16.0 mm	400 mm	20,22	1	4641-16-400

Ø	L	€		
16.0 mm	600 mm	26,02	1	4641-16-600
18.0 mm	400 mm	29,52	1	4641-18-400
18.0 mm	600 mm	35,03	1	4641-18-600
20.0 mm	400 mm	31,29	1	4641-20-400
20.0 mm	600 mm	40,59	1	4641-20-600
22.0 mm	400 mm	35,96	1	4641-22-400
24.0 mm	400 mm	37,28	1	4641-24-400
25.0 mm	400 mm	42,58	1	4641-25-400

Conjunto de brocas para betão com ponta de carboneto - 5 peças



4641-PB

X	g	€		
5	185 g	21,50	1	4641-PB

4641-4-75, 4641-5-85, 4641-6-100, 4641-8-120, 4641-10-120

Conjunto de brocas para alvenaria com ponta de carboneto - 5 peças



4643-PB

X	g	€		
5	150 g	12,63	1	4643-PB

4mm, 5mm, 6mm, 8mm and 10mm

Brocas cinzel SDS Max para betão armado



4659



Ø	L	€		
- mm	280 mm	16,76	1	4659-POINT-28
- mm	400 mm	20,01	1	4659-POINT-40
- mm	600 mm	27,03	1	4659-POINT-60
24.0 mm	280 mm	17,29	1	4659-FLAT-28
24.0 mm	400 mm	20,01	1	4659-FLAT-40
24.0 mm	600 mm	25,98	1	4659-FLAT-60
80.0 mm	300 mm	44,83	1	4659-WIDE-30-8
50.0 mm	360 mm	29,86	1	4659-WIDE-36-5
50.0 mm	300 mm	47,35	1	4659-TILE-30-5
80.0 mm	300 mm	49,76	1	4659-TILE-30-8

Brocas cinzel SDS+ para betão armado



4655



Ø	L	€		
20.0 mm	250 mm	11,11	1	4655-FLAT-250
22.0 mm	240 mm	22,83	1	4655-HOLLOW-240
- mm	250 mm	11,11	1	4655-POINT-250
32.0 mm	200 mm	146,64	1	4655-SLOT-25032
38.0 mm	200 mm	21,58	1	4655-TILE-20040
38.0 mm	200 mm	18,85	1	4655-WIDE-20040
22.0 mm	250 mm	54,99	1	4655-WING-C-250

Brocas de cobalto HSS-E para metal



4411



Ø	L	€		
1.00 mm	34 mm	4,72	1	4411-1.00
1.50 mm	40 mm	4,40	1	4411-1.50
2.00 mm	49 mm	4,61	1	4411-2.00
2.50 mm	57 mm	4,14	1	4411-2.50
3.00 mm	61 mm	3,98	1	4411-3.00
3.25 mm	65 mm	4,82	1	4411-3.25
3.30 mm	65 mm	4,82	1	4411-3.30
3.50 mm	70 mm	4,72	1	4411-3.50
4.00 mm	75 mm	5,14	1	4411-4.00
4.20 mm	75 mm	2,83	1	4411-4.20
4.25 mm	75 mm	2,83	1	4411-4.25
4.50 mm	80 mm	2,93	1	4411-4.50
5.00 mm	86 mm	3,04	1	4411-5.00
5.50 mm	93 mm	3,82	1	4411-5.50
6.00 mm	93 mm	3,98	1	4411-6.00
6.50 mm	101 mm	4,72	1	4411-6.50
6.80 mm	109 mm	4,51	1	4411-6.80

Ø	L	€		
7.00 mm	109 mm	5,14	1	4411-7.00
7.50 mm	109 mm	5,56	1	4411-7.50
8.00 mm	117 mm	6,49	1	4411-8.00
8.50 mm	117 mm	6,81	1	4411-8.50
9.00 mm	125 mm	8,59	1	4411-9.00
9.50 mm	125 mm	8,70	1	4411-9.50
10.00 mm	125 mm	9,54	1	4411-10.00
10.20 mm	133 mm	13,52	1	4411-10.20
10.50 mm	133 mm	14,17	1	4411-10.50
11.00 mm	142 mm	14,87	1	4411-11.00
11.50 mm	142 mm	16,95	1	4411-11.50
12.00 mm	151 mm	19,07	1	4411-12.00
12.50 mm	151 mm	21,38	1	4411-12.50
13.00 mm	151 mm	23,78	1	4411-13.00

Brocas de cobalto HSS-E para metal com conjunto industrial



4511

Ø	L	€		
0.50 mm	22 mm	26,60	1	4511-0.50-10P
0.75 mm	28 mm	24,04	1	4511-0.75-10P
1.00 mm	34 mm	19,48	1	4511-1.00-10P
1.50 mm	40 mm	18,55	1	4511-1.50-10P
1.75 mm	46 mm	23,25	1	4511-1.75-10P
2.00 mm	49 mm	19,48	1	4511-2.00-10P
2.50 mm	57 mm	17,70	1	4511-2.50-10P
2.70 mm	61 mm	21,94	1	4511-2.70-10P
2.90 mm	61 mm	21,94	1	4511-2.90-10P
3.00 mm	61 mm	17,29	1	4511-3.00-10P
3.10 mm	65 mm	21,15	1	4511-3.10-10P
3.25 mm	65 mm	21,15	1	4511-3.25-10P
3.30 mm	65 mm	21,15	1	4511-3.30-10P
3.50 mm	70 mm	21,15	1	4511-3.50-10P
3.80 mm	75 mm	26,60	1	4511-3.80-10P
4.00 mm	75 mm	22,42	1	4511-4.00-10P
4.20 mm	75 mm	24,93	1	4511-4.20-10P
4.50 mm	80 mm	25,13	1	4511-4.50-10P
4.80 mm	86 mm	29,54	1	4511-4.80-10P
5.00 mm	86 mm	26,60	1	4511-5.00-10P
5.20 mm	86 mm	32,16	1	4511-5.20-10P
5.50 mm	93 mm	33,73	1	4511-5.50-10P
6.00 mm	93 mm	35,82	1	4511-6.00-10P
6.20 mm	101 mm	44,83	1	4511-6.20-10P
6.50 mm	101 mm	43,05	1	4511-6.50-10P
6.80 mm	109 mm	50,18	1	4511-6.80-10P
7.00 mm	109 mm	47,24	1	4511-7.00-10P
7.20 mm	109 mm	68,34	1	4511-7.20-10P
7.50 mm	109 mm	50,18	1	4511-7.50-10P
7.80 mm	117 mm	82,23	1	4511-7.80-10P
8.00 mm	117 mm	59,07	1	4511-8.00-10P
8.50 mm	117 mm	61,17	1	4511-8.50-10P
8.60 mm	125 mm	100,04	1	4511-8.60-10P
8.80 mm	125 mm	100,04	1	4511-8.80-10P
9.00 mm	125 mm	78,56	1	4511-9.00-10P
9.20 mm	125 mm	110,93	1	4511-9.20-10P
9.50 mm	125 mm	81,18	1	4511-9.50-10P
9.60 mm	133 mm	130,41	1	4511-9.60-10P
10.00 mm	133 mm	44,53	1	4511-10.00-5P
10.20 mm	133 mm	62,85	1	4511-10.20-5P
10.30 mm	133 mm	74,89	1	4511-10.30-5P
10.50 mm	133 mm	63,05	1	4511-10.50-5P
10.80 mm	142 mm	87,15	1	4511-10.80-5P
11.00 mm	142 mm	69,66	1	4511-11.00-5P
11.50 mm	142 mm	83,28	1	4511-11.50-5P
12.00 mm	151 mm	89,25	1	4511-12.00-5P
12.50 mm	151 mm	108,67	1	4511-12.50-5P
12.80 mm	151 mm	124,12	1	4511-12.80-5P
13.00 mm	151 mm	111,03	1	4511-13.00-5P

Ø	L	€		
13.50 mm	160 mm	24,51	1	4511-13.50-1P
14.00 mm	160 mm	24,20	1	4511-14.00-1P
14.50 mm	169 mm	34,36	1	4511-14.50-1P
15.00 mm	169 mm	34,89	1	4511-15.00-1P
15.50 mm	169 mm	40,43	1	4511-15.50-1P
16.00 mm	178 mm	41,80	1	4511-16.00-1P
16.50 mm	184 mm	47,76	1	4511-16.50-1P
17.00 mm	184 mm	47,76	1	4511-17.00-1P
17.50 mm	191 mm	53,00	1	4511-17.50-1P
18.00 mm	191 mm	57,72	1	4511-18.00-1P
18.50 mm	198 mm	63,68	1	4511-18.50-1P
19.00 mm	198 mm	63,80	1	4511-19.00-1P
19.50 mm	205 mm	70,71	1	4511-19.50-1P
20.00 mm	205 mm	75,74	1	4511-20.00-1P

Conjunto de brocas de cobalto HSS-E para metal - 6 peças



4511-SET-6

X	g	€		
6	150 g	20,33	1	4511-SET-6

4411-2.00, 4411-3.00, 4411-4.00, 4411-5.00, 4411-6.00, 4411-8.00

Conjunto de brocas de cobalto HSS-E para metal - 19 peças



4511-SET-19

X	g	€		
19	600 g	82,65	1	4511-SET-19

4411-1.00, 4411-1.50, 4411-2.00, 4411-2.50, 4411-3.00, 4411-3.50, 4411-4.00, 4411-4.50, 4411-5.00, 4411-5.50, 4411-6.00, 4411-6.50, 4411-7.00, 4411-7.50, 4411-8.00, 4411-8.50, 4411-9.00, 4411-9.50, 4411-10.00



Conjunto de brocas de cobalto HSS-E para metal - 25 peças



4511-SET-25



		€		
25	1200 g	193,77	1	4511-SET-25

1x 1.0, 1.5; 2.0; 2.5; 3.0; 3.5; 4.0; 4.5; 5.0; 5.5; 6.0; 6.5; 7.0; 7.5; 8.0; 8.5; 9.0; 9.5; 10.0; 10.5; 11.0; 11.5; 12; 12.5; 13.0mm

Brocas HSS-G para metal



4413



Ø	L	€		
1.00 mm	34 mm	3,45	1	4413-1.00
1.50 mm	40 mm	2,73	1	4413-1.50
2.00 mm	49 mm	2,73	1	4413-2.00
2.50 mm	57 mm	2,73	1	4413-2.50
3.00 mm	61 mm	2,77	1	4413-3.00
3.25 mm	65 mm	2,77	1	4413-3.25
3.30 mm	65 mm	2,77	1	4413-3.30
3.50 mm	70 mm	2,77	1	4413-3.50
4.00 mm	75 mm	2,97	1	4413-4.00
4.20 mm	75 mm	1,85	1	4413-4.20
4.25 mm	75 mm	1,85	1	4413-4.25
4.50 mm	80 mm	1,95	1	4413-4.50
5.00 mm	86 mm	2,11	1	4413-5.00
5.50 mm	93 mm	2,90	1	4413-5.50
6.00 mm	93 mm	2,90	1	4413-6.00
6.50 mm	101 mm	3,39	1	4413-6.50
6.80 mm	109 mm	3,82	1	4413-6.80
7.00 mm	109 mm	3,98	1	4413-7.00
7.50 mm	109 mm	4,27	1	4413-7.50
8.00 mm	117 mm	4,54	1	4413-8.00
8.50 mm	117 mm	4,93	1	4413-8.50
9.00 mm	125 mm	6,27	1	4413-9.00
9.50 mm	125 mm	5,82	1	4413-9.50
10.00 mm	133 mm	5,95	1	4413-10.00
10.20 mm	133 mm	7,64	1	4413-10.20
10.50 mm	133 mm	7,95	25	4413-10.50
11.00 mm	142 mm	8,75	1	4413-11.00
11.50 mm	142 mm	9,48	25	4413-11.50
12.00 mm	151 mm	10,34	1	4413-12.00
12.50 mm	151 mm	11,28	25	4413-12.50
13.00 mm	151 mm	11,83	1	4413-13.00

Brocas HSS-G para metal com conjunto industrial



4513



Ø	L	€		
1.00 mm	34 mm	17,29	1	4513-1.00-10P
1.50 mm	40 mm	12,89	1	4513-1.50-10P
1.75 mm	46 mm	14,35	1	4513-1.75-10P
2.00 mm	49 mm	12,15	1	4513-2.00-10P
2.50 mm	57 mm	12,47	1	4513-2.50-10P
2.70 mm	61 mm	15,09	1	4513-2.70-10P
2.90 mm	61 mm	15,09	1	4513-2.90-10P
3.00 mm	61 mm	11,00	1	4513-3.00-10P
3.10 mm	65 mm	12,89	1	4513-3.10-10P
3.25 mm	65 mm	12,89	1	4513-3.25-10P
3.30 mm	65 mm	12,89	1	4513-3.30-10P
3.50 mm	70 mm	12,89	1	4513-3.50-10P
3.80 mm	75 mm	18,33	1	4513-3.80-10P
4.00 mm	75 mm	16,34	1	4513-4.00-10P
4.20 mm	75 mm	18,02	1	4513-4.20-10P
4.50 mm	80 mm	18,85	1	4513-4.50-10P
4.80 mm	86 mm	20,64	1	4513-4.80-10P
5.00 mm	86 mm	20,69	1	4513-5.00-10P
5.20 mm	86 mm	23,05	1	4513-5.20-10P
5.50 mm	93 mm	26,81	1	4513-5.50-10P
6.00 mm	93 mm	27,65	1	4513-6.00-10P
6.20 mm	101 mm	31,42	1	4513-6.20-10P
6.50 mm	101 mm	32,26	1	4513-6.50-10P
6.80 mm	109 mm	36,87	1	4513-6.80-10P
7.00 mm	109 mm	38,97	1	4513-7.00-10P
7.20 mm	109 mm	49,23	1	4513-7.20-10P
7.50 mm	109 mm	41,48	1	4513-7.50-10P
7.80 mm	117 mm	60,26	1	4513-7.80-10P
8.00 mm	117 mm	46,93	1	4513-8.00-10P
8.50 mm	117 mm	51,11	1	4513-8.50-10P
8.60 mm	125 mm	80,96	1	4513-8.60-10P
8.80 mm	125 mm	82,68	1	4513-8.80-10P
9.00 mm	125 mm	62,00	1	4513-9.00-10P
9.20 mm	125 mm	84,04	1	4513-9.20-10P
9.50 mm	125 mm	59,76	1	4513-9.50-10P
9.60 mm	133 mm	95,01	1	4513-9.60-10P
10.00 mm	133 mm	30,13	1	4513-10.00-5P
10.20 mm	133 mm	37,90	1	4513-10.20-5P
10.30 mm	133 mm	48,06	1	4513-10.30-5P
10.50 mm	133 mm	39,43	1	4513-10.50-5P
10.80 mm	142 mm	59,28	1	4513-10.80-5P
11.00 mm	142 mm	43,07	1	4513-11.00-5P
11.50 mm	142 mm	47,13	1	4513-11.50-5P
12.00 mm	151 mm	51,45	1	4513-12.00-5P
12.50 mm	151 mm	56,31	1	4513-12.50-5P
12.80 mm	151 mm	98,58	1	4513-12.80-5P
13.00 mm	151 mm	58,84	1	4513-13.00-5P
13.50 mm	160 mm	20,32	1	4513-13.50-1P
14.00 mm	160 mm	21,87	1	4513-14.00-1P
14.50 mm	169 mm	23,46	1	4513-14.50-1P
15.00 mm	169 mm	23,76	1	4513-15.00-1P
15.50 mm	178 mm	27,15	1	4513-15.50-1P
16.00 mm	178 mm	28,94	1	4513-16.00-1P
16.50 mm	184 mm	32,01	1	4513-16.50-1P
17.00 mm	184 mm	32,01	1	4513-17.00-1P
17.50 mm	191 mm	36,84	1	4513-17.50-1P
18.00 mm	191 mm	38,97	1	4513-18.00-1P

Ø	L	€		
18.50 mm	198 mm	43,24	1	4513-18.50-1P
19.00 mm	198 mm	43,24	1	4513-19.00-1P
19.50 mm	205 mm	46,39	1	4513-19.50-1P
20.00 mm	205 mm	52,79	1	4513-20.00-1P

Conjunto de brocas HSS-G para metal - 6 peças



4513-SET-6



		€		
6	150 g	15,89	1	4513-SET-6

4413-2.00, 4413-3.00, 4413-4.00, 4413-5.00, 4413-6.00, 4413-8.00

Conjunto de brocas HSS-G para metal - 19 peças



4513-SET-19



		€		
19	600 g	57,11	1	4513-SET-19

4413-1.00, 4413-1.50, 4413-2.00, 4413-2.50, 4413-3.00, 4413-3.50, 4413-4.00, 4413-4.50, 4413-5.00, 4413-5.50, 4413-6.00, 4413-6.50, 4413-7.00, 4413-7.50, 4413-8.00, 4413-8.50, 4413-9.00, 4413-9.50, 4413-10.00

Conjunto de brocas HSS-G para metal - 25 peças



4513-SET-25

		€		
25	1200 g	121,82	1	4513-SET-25

1x 1.0, 1.5; 2.0; 2.5; 3.0; 3.5; 4.0; 4.5; 5.0; 5.5; 6.0; 6.5; 7.0; 7.5; 8.0; 8.5; 9.0; 9.5; 10.0; 10.5; 11.0; 11.5; 12; 12.5; 13.0 mm

		€		
12.50 mm	151 mm	3,68	1	4415-12.50
13.00 mm	151 mm	3,88	1	4415-13.00
13.50 mm	160 mm	5,18	1	4415-13.50
14.00 mm	160 mm	5,55	1	4415-14.00
14.50 mm	169 mm	6,28	1	4415-14.50
15.00 mm	169 mm	6,78	1	4415-15.00
15.50 mm	178 mm	7,52	1	4415-15.50
16.00 mm	178 mm	8,06	1	4415-16.00
16.50 mm	184 mm	8,61	1	4415-16.50
17.00 mm	184 mm	9,11	1	4415-17.00
17.50 mm	191 mm	10,06	1	4415-17.50
18.00 mm	191 mm	10,41	1	4415-18.00
18.50 mm	198 mm	11,33	1	4415-18.50
19.00 mm	198 mm	11,83	1	4415-19.00
19.50 mm	205 mm	12,31	1	4415-19.50
20.00 mm	205 mm	12,93	1	4415-20.00

Brocas HSS-G para metal com conjunto industrial



Brocas HSS-R para metal



4415

		€		
1.00 mm	34 mm	0,91	1	4415-1.00
1.50 mm	40 mm	0,91	1	4415-1.50
2.00 mm	49 mm	0,91	1	4415-2.00
2.50 mm	57 mm	0,91	1	4415-2.50
3.00 mm	61 mm	0,91	1	4415-3.00
3.25 mm	65 mm	1,04	1	4415-3.25
3.50 mm	70 mm	1,12	1	4415-3.50
4.00 mm	75 mm	1,12	1	4415-4.00
4.25 mm	75 mm	0,76	1	4415-4.25
4.50 mm	80 mm	0,83	1	4415-4.50
5.00 mm	86 mm	0,83	1	4415-5.00
5.50 mm	93 mm	0,91	1	4415-5.50
6.00 mm	93 mm	0,95	1	4415-6.00
6.50 mm	101 mm	1,04	1	4415-6.50
7.00 mm	109 mm	1,12	1	4415-7.00
7.50 mm	109 mm	1,31	1	4415-7.50
8.00 mm	117 mm	1,58	1	4415-8.00
8.50 mm	117 mm	1,78	1	4415-8.50
9.00 mm	125 mm	1,88	1	4415-9.00
10.00 mm	125 mm	2,21	1	4415-10.00
10.50 mm	133 mm	2,40	1	4415-10.50
11.00 mm	142 mm	2,93	1	4415-11.00
11.50 mm	142 mm	3,15	1	4415-11.50
12.00 mm	151 mm	3,46	1	4415-12.00

4515

		€		
1.00 mm	34 mm	3,66	1	4515-1.00-10P
1.50 mm	40 mm	3,66	1	4515-1.50-10P
2.00 mm	49 mm	3,66	1	4515-2.00-10P
2.50 mm	57 mm	3,66	1	4515-2.50-10P
3.00 mm	61 mm	3,66	1	4515-3.00-10P
3.25 mm	65 mm	5,03	1	4515-3.25-10P
3.50 mm	70 mm	5,48	1	4515-3.50-10P
4.00 mm	75 mm	5,48	1	4515-4.00-10P
4.25 mm	75 mm	6,77	1	4515-4.25-10P
4.50 mm	80 mm	6,77	1	4515-4.50-10P
5.00 mm	86 mm	7,25	1	4515-5.00-10P
5.50 mm	93 mm	8,22	1	4515-5.50-10P
6.00 mm	93 mm	8,70	1	4515-6.00-10P
6.50 mm	101 mm	9,18	1	4515-6.50-10P
7.00 mm	109 mm	12,70	1	4515-7.00-10P
7.50 mm	109 mm	14,01	1	4515-7.50-10P
8.00 mm	117 mm	14,99	1	4515-8.00-10P
8.50 mm	117 mm	18,33	1	4515-8.50-10P
9.00 mm	125 mm	20,58	1	4515-9.00-10P
9.50 mm	125 mm	22,86	1	4515-9.50-10P
10.00 mm	133 mm	23,05	1	4515-10.00-10P
10.50 mm	133 mm	12,70	1	4515-10.50-5P
11.00 mm	142 mm	14,82	1	4515-11.00-5P
11.50 mm	142 mm	15,77	1	4515-11.50-5P
12.00 mm	151 mm	16,23	1	4515-12.00-5P
12.50 mm	151 mm	17,38	1	4515-12.50-5P
13.00 mm	151 mm	18,53	1	4515-13.00-5P

Conjunto de brocas HSS-R para metal - 19 peças



4515-SET-19

		€		
19	600 g	22,62	1	4515-SET-19

1x 1.0mm; 1.5mm; 2.0mm; 2.5mm; 3.0mm; 3.5mm; 4.0mm; 4.5mm; 5.0mm; 5.5mm; 6.0mm; 6.5mm; 7mm; 7.5mm; 8mm; 8.5mm; 9.0mm; 9.5mm; 10mm

Conjunto de brocas HSS-R para metal - 25 peças



4515-SET-25

		€		
25	1200 g	44,21	1	4515-SET-25

1x 1.0; 1.5; 2.0; 2.5; 3.0; 3.5; 4.0; 4.5; 5.0; 5.5; 6.0; 6.5; 7; 7.5; 8; 8.5; 9.0; 9.5; 10; 10.5; 11; 11.5; 12; 12.5; 13 mm

Broca diâmetros múltiplos



228-SD

		€		
6.35 mm	4-5-6-7-8-9-10-11-12 mm	23,68	24	228-SD



Broca diâmetros múltiplos



229-SD

Ø	L	€	Box	Icon
10 mm	4-6-8-10-12-14-16-18-20-22 mm	32,46	24	229-SD

Broca escalonada



230-SD

Ø	L	€	Box	Icon
12.7 mm	5-13-15-17-19-21-23-25-27-29-31-33-35 mm	72,93	25	230-SD

5-13-15-17-19-21-23-25-27-29-31-33-35 mm

Broca diâmetros múltiplos, 6 a 37mm



232-SD

Ø	L	€	Box	Icon
10 mm	6-9-12.5-15.2-18.6-20.4-22.5-26-28.3-30.5-34-37 mm	124,05	1	232-SD

Broca diâmetros múltiplos, 6.5 a 40.5mm



234-SD

Ø	L	€	Box	Icon
10 mm	6.5-8.5-10.5-12.5-16.5-20.5-25.5-29-32.5-36.5-40.5 mm	138,79	25	234-SD

Jogo Brocas Cônicas HSS



228-SET

Box	g	€	Box	Icon
3	560 g	130,27	1	228-SET-SD

- 228-SD
- 229-SD
- 230-SD

Brocas de escarear em HSS-G para metal



4435

Ø	L	€	Box	Icon
12.4 mm	56 mm	7,61	1	4435-12.4

Brocas Auger para madeira



9626

Ø	€	Box	Icon
6.0 mm	14,70	1	9626-6
7.0 mm	15,11	1	9626-7
8.0 mm	15,48	1	9626-8
9.0 mm	16,07	1	9626-9
10.0 mm	16,43	1	9626-10
11.0 mm	16,71	1	9626-11
12.0 mm	17,08	1	9626-12
13.0 mm	17,52	1	9626-13
14.0 mm	18,05	1	9626-14
15.0 mm	18,85	1	9626-15
16.0 mm	20,67	1	9626-16
18.0 mm	26,38	1	9626-18
20.0 mm	29,90	1	9626-20
22.0 mm	33,42	1	9626-22
23.0 mm	35,04	1	9626-23
24.0 mm	36,63	1	9626-24
25.0 mm	38,31	1	9626-25
26.0 mm	39,98	1	9626-26
28.0 mm	47,19	1	9626-28
30.0 mm	67,56	1	9626-30
32.0 mm	67,56	1	9626-32
35.0 mm	67,56	1	9626-35
6.0 mm	25,23	1	9627-6-460
8.0 mm	25,58	1	9627-8-460
10.0 mm	25,91	1	9627-10-460
12.0 mm	26,24	1	9627-12-460
14.0 mm	28,26	1	9627-14-460
16.0 mm	29,60	1	9627-16-460
18.0 mm	34,32	1	9627-18-460
20.0 mm	38,69	1	9627-20-460
22.0 mm	40,37	1	9627-22-460
24.0 mm	43,75	1	9627-24-460
26.0 mm	47,10	1	9627-26-460
28.0 mm	48,78	1	9627-28-460
30.0 mm	59,70	1	9627-30-460
32.0 mm	67,28	1	9627-32-460

Conjunto de brocas helicoidais 6 peças.
10, 13, 16, 19, 22, 25mm



SB-9526/S6

Box	€	Box	Icon
6	47,03	20	SB-9526/S6

10, 13, 16, 19, 22, 25mm

9526-10, 9526-13, 9526-19, 9526-22, 9526-25
9526-16

Brocas planas para madeira



9629

Ø	L	€		
6.0 mm	152 mm	7,07	1	9629-6
8.0 mm	152 mm	5,28	1	9629-8
10.0 mm	152 mm	6,01	1	9629-10
12.0 mm	152 mm	6,01	1	9629-12
13.0 mm	152 mm	5,70	1	9629-13
14.0 mm	152 mm	6,38	1	9629-14
16.0 mm	152 mm	6,38	1	9629-16
17.0 mm	152 mm	6,38	1	9629-17
18.0 mm	152 mm	6,38	1	9629-18
19.0 mm	152 mm	6,38	1	9629-19
20.0 mm	152 mm	6,95	1	9629-20
22.0 mm	152 mm	6,95	1	9629-22
24.0 mm	152 mm	6,95	1	9629-24
25.0 mm	152 mm	6,95	1	9629-25
26.0 mm	152 mm	6,59	1	9629-26
28.0 mm	152 mm	10,85	1	9629-28
30.0 mm	152 mm	10,89	1	9629-30
32.0 mm	152 mm	10,94	1	9629-32
35.0 mm	152 mm	10,75	1	9629-35
36.0 mm	152 mm	11,64	1	9629-36
38.0 mm	152 mm	12,78	1	9629-38
40.0 mm	152 mm	12,78	1	9629-40
6.0 mm	400 mm	9,67	1	9631-6-400
8.0 mm	400 mm	9,67	1	9631-8-400
10.0 mm	400 mm	10,17	1	9631-10-400
12.0 mm	400 mm	11,28	1	9631-12-400
13.0 mm	400 mm	8,80	1	9631-13-400
14.0 mm	400 mm	9,64	1	9631-14-400
16.0 mm	400 mm	10,62	1	9631-16-400
18.0 mm	400 mm	11,97	1	9631-18-400
19.0 mm	400 mm	10,84	1	9631-19-400
20.0 mm	400 mm	11,97	1	9631-20-400
22.0 mm	400 mm	13,85	1	9631-22-400
24.0 mm	400 mm	14,87	1	9631-24-400
25.0 mm	400 mm	14,50	1	9631-25-400
28.0 mm	400 mm	18,04	1	9631-28-400
30.0 mm	400 mm	19,10	1	9631-30-400
32.0 mm	400 mm	21,62	1	9631-32-400
35.0 mm	400 mm	19,69	1	9631-35-400
38.0 mm	400 mm	19,83	1	9631-38-400

Conjunto de brocas planas para madeira - 8 peças



9629-SET-8

X	g	€		
8	630 g	30,81	12	9629-SET-8

9629-12, 9629-16, 9629-18, 9629-20, 9629-22, 9629-25, 9629-28, 9629-32



Conjunto de brocas Brad Point para madeira - 6 peças



9656-SET-6

X	g	€		
6	720 g	65,31	1	9656-SET-6

Brocas Brad Point para madeira



9646

Ø	€		
3 mm	3,46	1	9646-3
4 mm	3,81	1	9646-4
5 mm	4,15	1	9646-5
6 mm	4,50	1	9646-6
7 mm	4,85	1	9646-7
8 mm	5,55	1	9646-8
9 mm	6,07	1	9646-9
10 mm	6,58	1	9646-10
11 mm	7,61	1	9646-11
12 mm	9,70	1	9646-12
13 mm	10,37	1	9646-13
14 mm	12,11	1	9646-14
15 mm	12,82	1	9646-15
16 mm	12,82	1	9646-16
18 mm	19,06	1	9646-18
20 mm	19,06	1	9646-20
6 mm	5,02	1	9646-6-250
8 mm	6,07	1	9646-8-250
10 mm	7,09	1	9646-10-250
12 mm	10,23	1	9646-12-250

Conjunto de brocas Brad Point para madeira - 5 peças



9646-SET-5

X	g	€		
5	110 g	10,64	1	9646-SET-5

9646-4, 9646-5, 9646-6, 9646-8, 9646-10

Conjunto de brocas Brad Point para madeira - 8 peças



9646-SET-8

X	g	€		
8	230 g	13,80	1	9646-SET-8

9646-3, 9646-4, 9646-5, 9646-6, 9646-7, 9646-8, 9646-9, 9646-10

Broca extensível para madeira



9528

Ø	€		
15-45 mm	40,34	10	9528-MD-15-45



Brocas para azulejos



4626

Ø	L	€	Icon 1	Icon 2
4 mm	58 mm	5,54	1	4626-4.0
5 mm	58 mm	6,10	1	4626-5.0
6 mm	58 mm	6,40	1	4626-6.0
8 mm	78 mm	7,64	1	4626-8.0
10 mm	98 mm	9,25	1	4626-10.0

Haste de extensão de 305 mm 1/4" de substituição rápida



9625-6.35QC

Ø	L	€	Icon 1	Icon 2
6.35 mm	305 mm	27,11	1	9625-6.35QC

Pontas de aparafusadora de torção diamantadas 1/4" para parafusos Phillips para placas de gesso de 25 mm



63D/PH2G

Icon X	Icon 1	€	Icon 2	Icon 3
5	PH2G	19,90	1	63D/PH2G

Brocas multifunções para azulejos, pedra natural, madeira e plásticos



4629

Ø	L	€	Icon 1	Icon 2
4.0 mm	75 mm	5,30	1	4629-4.0
5.0 mm	85 mm	5,55	1	4629-5.0
6.0 mm	100 mm	6,16	1	4629-6.0
8.0 mm	120 mm	7,40	1	4629-8.0
10.0 mm	120 mm	8,25	1	4629-10.0

Extensão para brocas puas 300mm



9525

Ø	€	Icon 1	Icon 2
7 mm	14,62	1	9525-7
10 mm	18,60	1	9525-10

Pontas de aparafusadora de torção diamantadas 1/4" para parafusos Pozidriv de 25 mm



63D/PZ

Icon X	Icon 1	€	Icon 2	Icon 3
5	1	16,88	1	63D/PZ1
5	2	16,88	1	63D/PZ2

Conjunto de brocas multifunções com ponta de carboneto - 5 peças



4629-SET-5

Icon X	g	€	Icon 1	Icon 2
5	165 g	35,55	10	4629-SET-5

4629-8.0, 4629-10.0, 4629-4.0, 4629-5.0, 4629-6.0

BITS PARA CHAVES DE PARAFUSOS

Pontas de aparafusadora de torção diamantadas 1/4" para parafusos Phillips de 25 mm



63D/PH

Icon X	Icon 1	€	Icon 2	Icon 3
5	3	16,88	1	63D/PH3

Pontas de aparafusadora de torção diamantadas 1/4" para parafusos TORX® de 25 mm



63D/T

Icon X	Icon 1	€	Icon 2	Icon 3
5	T10	19,30	1	63D/T10
5	T15	19,30	1	63D/T15
5	T40	19,30	1	63D/T40

Bit diamantado para parafusos Pozidriv, 50mm



63D/50PZ

QTY	PKT	€	PKT	PKT
5	1	26,53	1	63D/50PZ1
5	2	26,53	1	63D/50PZ2
5	3	26,53	1	63D/50PZ3

Pontas para aparafusadora de torção em estanho 1/4" para parafusos Pozidriv de 25 mm



62TIN/PZ

QTY	PKT	€	PKT	PKT
10	1	20,51	1	62TIN/PZ1
10	2	20,51	1	62TIN/PZ2
10	3	20,51	1	62TIN/PZ3

Pontas para aparafusadora de torção em estanho 1/4" para parafusos Pozidriv de 50 mm



62TIN/50PZ

QTY	PKT	€	PKT	PKT
5	1	22,30	1	62TIN/50PZ1
5	2	22,30	1	62TIN/50PZ2
5	3	22,30	1	62TIN/50PZ3

Conjunto de 7peças de bits diamantados para parafusos Pozidriv, Phillips, TORX® e suporte para bits



63D/7

QTY	Dimensões	€	PKT	PKT
7	20 x 50 x 80 mm	28,85	1	63D/7-1

- 63D/PH2
- 63D/PZ2
- 63D/T10, 63D/T15, 63D/T25, 63D/T30

Pontas para aparafusadora de torção em estanho 1/4" para parafusos TORX® de 25 mm



62TIN/T

QTY	PKT	€	PKT	PKT
10	T15	25,32	1	62TIN/T15
10	T20	25,32	1	62TIN/T20
10	T25	25,32	1	62TIN/T25
10	T30	25,32	1	62TIN/T30

Conjunto de 7peças de bits TIN para parafusos Pozidriv, Phillips, TORX® e suporte para bits



62TIN/7

QTY	Dimensões	€	PKT	PKT
7	22 x 65 x 75 mm	22,95	1	62TIN/7-1

- 62TIN/PH2
- 62TIN/PZ2
- 62TIN/T15, 62TIN/T20, 62TIN/T25, 62TIN/T30

Pontas para aparafusadora de torção em estanho 1/4" para parafusos Phillips de 25 mm



62TIN/PH

QTY	PKT	€	PKT	PKT
10	1	20,51	1	62TIN/PH1

Pontas para aparafusadora de torção em estanho 1/4" para parafusos Phillips de 50 mm



62TIN/50PH

QTY	PKT	€	PKT	PKT
5	1	22,30	1	62TIN/50PH1
5	3	22,30	1	62TIN/50PH3

Pontas de aparafusadora de torção ACR 1/4" para parafusos Phillips de 25 mm



64A/PH

QTY	PKT	€	PKT	PKT
10	1	14,95	1	64A/PH1
10	3	14,95	1	64A/PH3



Pontas de aparafusadora de torção ACR 1/4" para parafusos Pozidriv de 25 mm



64A/PZ

X	+	€		
10	1	14,95	1	64A/PZ1
10	3	14,95	1	64A/PZ3

Pontas de aparafusadora de torção 1/4" para parafusos Phillips de 25 mm



60T/PH

X	+	€		
10	1	10,86	1	60T/PH1
10	2	10,86	1	60T/PH2
10	3	10,86	1	60T/PH3

Pontas de aparafusadora de torção 1/4" para parafusos Pozidriv de 25 mm



60T/PZ

X	+	€		
10	1	10,86	1	60T/PZ1
10	2	10,86	1	60T/PZ2
10	3	10,86	1	60T/PZ3

Pontas de aparafusadora de torção 1/4" para parafusos TORX® de 25 mm



60T/T

X	+	€		
10	T7	16,88	1	60T/T7
10	T9	16,88	1	60T/T9
10	T15	16,88	1	60T/T15
10	T20	16,88	1	60T/T20
10	T25	16,88	1	60T/T25
10	T27	16,88	1	60T/T27
10	T40	16,88	1	60T/T40

Conjunto de 7 peças de bits TORSION para parafusos Pozidriv, Phillips e TORX® e suporte para bits



60T/7

X		€		
7	22 x 65 x 75 mm	17,59	1	60T/7-1

60T/PH2	
60T/PZ2	
60T/T10, 60T/T15, 60T/T20, 60T/T30	

Conjunto de 17 peças de bits TORSION para parafusos Phillips, TORX®, Pozidriv e suporte



60T/17

X		€		
17	27 x 73 x 82 mm	28,88	1	60T/17-1

60T/PH1, 60T/PH2	
60T/T7, 60T/T8, 60T/T9, 60T/T10, 60T/T15x 2, 60T/T20x 2, 60T/T25x 2, 60T/T27, 60T/T30x 2, 60T/T40	

Jogo Bits impacto 31 peças TORX



60T/31

X		€		
31	42 x 65 x 110 mm	37,78	1	60T/31-1

59S/0.6-4.5, 59S/0.8-5.5	
60T/PH1, 60T/PH2x 3, 60T/PH3	
59S/PH2Gx 2	
60T/PZ1, 60T/PZ2x 3, 60T/PZ3	
60T/T10, 60T/T15x 3, 60T/T20x 3, 60T/T25x 2, 60T/T27, 60T/T30x 2	
59S/H3, 59S/H4, 59S/H5, 59S/H6	

Pontas de aparafusadora de torção extraduras 1/4" para parafusos Phillips de 25 mm



61H/PH

X	+	€		
10	1	11,58	1	61H/PH1
10	2	11,58	1	61H/PH2
5	3	5,79	1	61H/PH3

Pontas de aparafusadora de torção extraduras 1/4" para parafusos Phillips de 50 mm



61H/50PH

X	+	€		
5	1	14,72	1	61H/50PH1

Pontas de aparafusadora de torção extraduras 1/4" para parafusos Pozidriv de 25 mm



61H/PZ

X	+	€		
5	3	5,79	1	61H/PZ3

Pontas de aparafusadora de torção extraduras 1/4" para parafusos Pozidriv de 50 mm



61H/50PZ

X	+	€		
5	1	14,72	1	61H/50PZ1
5	2	14,72	1	61H/50PZ2
5	3	14,72	1	61H/50PZ3

Pontas de aparafusadora de torção extraduras 1/4" para parafusos TORX® de 50 mm



61H/50T

X	+	€		
5	T10	18,68	1	61H/50T10
5	T15	18,68	1	61H/50T15
5	T25	18,68	1	61H/50T25
5	T30	18,68	1	61H/50T30

Pontas de aparafusadora de torção extraduras 1/4" para parafusos TORX® de 25 mm



61H/T

X	+	€		
10	T10	17,83	1	61H/T10
10	T15	17,83	1	61H/T15
10	T20	17,83	1	61H/T20
10	T25	17,83	1	61H/T25
5	T40	8,93	1	61H/T40

Pontas de aparafusadora de torção- 1/4" de uso muito intensivo para parafusos Phillips de 25 mm



66IM/PH

X	+	€		
2	1	3,05	1	66IM/PH1-2P
2	2	3,05	1	66IM/PH2-2P
2	3	3,05	1	66IM/PH3-2P

Pontas de aparafusadora de torção 1/4" de uso muito intensivo para parafusos Pozidriv de 25 mm



66IM/PZ

X	+	€		
2	1	3,05	1	66IM/PZ1-2P
2	2	3,05	1	66IM/PZ2-2P
2	3	3,05	1	66IM/PZ3-2P

Pontas de aparafusadora de torção 1/4" de uso muito intensivo para parafusos TORX® de 25 mm



66IM/T

X	+	€		
2	T10	3,14	1	66IM/T10C-2P
2	T15	3,14	1	66IM/T15C-2P
2	T20	3,14	1	66IM/T20C-2P
2	T25	3,14	1	66IM/T25C-2P
2	T27	3,14	1	66IM/T27C-2P
2	T20	3,14	1	66IM/T30C-2P
2	T40	3,14	1	66IM/T40C-2P

Pontas de aparafusadora de torção- 1/4" de uso muito intensivo para parafusos Phillips de 50 mm



66IM/50PH

X	+	€		
2	1	3,88	1	66IM/50PH1-2P
2	2	3,88	1	66IM/50PH2-2P
2	3	3,88	1	66IM/50PH3-2P



Pontas de aparafusadora de torção 1/4" de uso muito intensivo para parafusos Pozidriv de 50 mm



66IM/50PZ

X		€		
2	1	3,88	1	66IM/50PZ1-2P
2	2	3,88	1	66IM/50PZ2-2P
2	3	3,88	1	66IM/50PZ3-2P

Pontas de aparafusadora de torção 1/4" de uso muito intensivo para parafusos TORX® de 50 mm



66IM/50TC

X		€		
2	10	3,93	1	66IM/50T10C-2P
2	15	3,93	1	66IM/50T15C-2P
2	20	3,93	1	66IM/50T20C-2P
2	25	3,93	1	66IM/50T25C-2P
2	27	3,93	1	66IM/50T27C-2P
2	30	3,93	1	66IM/50T30C-2P
2	40	3,93	1	66IM/50T40C-2P

Conjunto de pontas de torção de alta resistência 1/4" para Phillips/Pozidriv/TORX® com suporte de plástico macio - 11 peças



66IM/11C-1

X		€		
11	25 x 37 x 140 mm	17,68	1	66IM/11C-1

66IM/PH2-2Px 2, 66IM/PH3-2P				
66IM/PZ2-2Px 2, 66IM/PZ3-2P				
66IM/T20C-2Px 2, 66IM/T25C-2P, 66IM/T30C-2P				
KMT753-QR-1P				

Conjunto de pontas de torção de alta resistência 1/4" para Phillips/Pozidriv/TORX® com suporte de plástico macio - 10 peças



66IM/10C-1

X		€		
10	10 x 50 x 140 mm	22,11	1	66IM/10C-1

66IM/50PH2-2Px 2, 66IM/50PH3-2P				
66IM/50PZ2-2Px 2, 66IM/50PZ3-2P				
66IM/50T20C-2Px 2, 66IM/50T25C-2P, 66IM/50T30C-2P				

Pontas de aparafusadora standard 1/4" para parafusos de fenda de 25 mm



59S/

X		€		
10	3.0 mm	12,68	1	59S/0.5-3.0
3	3.0 mm	3,81	1	59S/0.5-3.0-3P
10	4.0 mm	12,68	1	59S/0.5-4.0
3	4.0 mm	3,81	1	59S/0.5-4.0-3P
10	3.5 mm	12,68	1	59S/0.6-3.5
3	3.5 mm	3,81	1	59S/0.6-3.5-3P
10	4.5 mm	12,68	1	59S/0.6-4.5
3	4.5 mm	3,81	1	59S/0.6-4.5-3P
10	5.5 mm	12,68	1	59S/0.8-5.5
3	5.5 mm	3,81	1	59S/0.8-5.5-3P
10	5.5 mm	12,68	1	59S/1.0-5.5
3	5.5 mm	3,81	1	59S/1.0-5.5-3P
10	6.5 mm	12,68	1	59S/1.2-6.5
3	6.5 mm	3,81	1	59S/1.2-6.5-3P
10	8.0 mm	20,60	1	59S/1.2-8.0
3	8.0 mm	6,19	1	59S/1.2-8.0-3P
10	9.0 mm	20,60	1	59S/1.6-9.0
10	10 mm	20,60	1	59S/1.6-10
3	9.0 mm	6,19	1	59S/1.6-9.0-3P
3	10.0 mm	6,19	1	59S/1.6-10-3P

Pontas de aparafusadora standard 1/4" para parafusos Phillips de 25 mm



59S/PH

X		€		
10	0	6,62	1	59S/PH0
3	0	2,54	1	59S/PH0-3P
3	1	3,31	1	59S/PH1-3P
30	1	18,56	1	59S/PH1-30P
100	*1	0,52	100	59S/PH1-IP
500	1	0,47	500	59S/PH1-IPB
10	2	6,62	1	59S/PH2
3	2	3,31	1	59S/PH2-3P
30	2	18,56	1	59S/PH2-30P
100	*2	0,52	100	59S/PH2-IP
500	*2	0,47	500	59S/PH2-IPB
3	3	3,31	1	59S/PH3-3P
30	3	18,56	1	59S/PH3-30P
500	3	0,47	500	59S/PH3-IPB
10	4	13,45	1	59S/PH4
3	4	4,32	1	59S/PH4-3P

Pontas de aparafusadora standard 1/4" para parafusos Phillips para placas de gesso de 25 mm



59S/PH2G

X		€		
3	PH 2G	3,88	1	59S/PH2G-3P
30	PH2G	35,44	1	59S/PH2G-30P

Pontas de aparafusadora standard 1/4" para parafusos Pozidriv de 25 mm



59S/PZ

X	Icon	€	Icon	Icon
10	0	8,46	1	59S/PZ0
3	0	2,54	1	59S/PZ0-3P
10	1	6,62	1	59S/PZ1
3	1	3,31	1	59S/PZ1-3P
30	1	18,56	1	59S/PZ1-30P
100	*1	0,61	100	59S/PZ1-IP
500	*1	0,47	500	59S/PZ1-IPB
3	2	3,31	1	59S/PZ2-3P
30	2	18,56	1	59S/PZ2-30P
100	*2	0,52	100	59S/PZ2-IP
500	*2	0,47	500	59S/PZ2-IPB
10	3	6,62	1	59S/PZ3
3	3	3,31	1	59S/PZ3-3P
30	3	18,56	1	59S/PZ3-30P
500	3	0,47	500	59S/PZ3-IPB
10	4	13,45	1	59S/PZ4

Pontas de aparafusadora standard 1/4" para parafusos TORX® de 25 mm



59S/T

X	Icon	€	Icon	Icon
5	T3	9,26	1	59S/T3
3	T3	5,55	1	59S/T3-3P
5	T4	9,26	1	59S/T4
3	T4	5,55	1	59S/T4-3P
5	T5	9,26	1	59S/T5
3	T5	5,55	1	59S/T5-3P
10	T6	11,11	1	59S/T6
3	T6	5,55	1	59S/T6-3P
10	T7	11,11	1	59S/T7
3	T7	5,55	1	59S/T7-3P
10	T8	11,11	1	59S/T8
3	T8	5,55	1	59S/T8-3P
10	T9	11,11	1	59S/T9
3	T9	5,55	1	59S/T9-3P
10	T10	11,11	1	59S/T10
3	T10	5,55	1	59S/T10-3P

X	Icon	€	Icon	Icon
30	T10	30,91	1	59S/T10-30P
10	T15	10,00	1	59S/T15-10P
3	T15	5,55	1	59S/T15-3P
30	T15	30,91	1	59S/T15-30P
3	T20	5,55	1	59S/T20-3P
30	T20	30,91	1	59S/T20-30P
10	T25	11,11	1	59S/T25
3	T25	5,55	1	59S/T25-3P
30	T25	30,91	1	59S/T25-30P
10	T27	11,11	1	59S/T27
3	T27	5,55	1	59S/T27-3P
5	T30	10,00	1	59S/T30-10P
3	T30	7,43	1	59S/T30-3P
30	T30	34,49	1	59S/T30-30P
5	T40	12,38	1	59S/T40
3	T40	7,43	1	59S/T40-3P
30	T40	34,48	1	59S/T40-30P
3	T45	10,31	1	59S/T45-3P
5	T45	17,17	1	59S/T45-5P
5	T50	17,17	1	59S/T50
3	T50	10,31	1	59S/T50-3P

Pontas cónicas para aparafusadora padrão 1/4" para parafusos TORX® de 25 mm



59S/TCS

X	Icon	€	Icon	Icon
10	T10	9,00	1	59S/T10CS
10	T15	9,00	1	59S/T15CS
10	T20	9,00	1	59S/T20CS
10	T25	9,00	1	59S/T25CS
10	T27	9,00	1	59S/T27CS
10	T30	29,72	1	59S/T30CS
10	T40	29,72	1	59S/T40CS

Pontas de aparafusadora standard 1/4" para parafusos TORX® inoxidáveis de 25 mm



59S/TR

X	Icon	€	Icon	Icon
5	TR 7	13,62	1	59S/TR7
3	TR7	8,17	1	59S/TR7-3P

X	Icon	€	Icon	Icon
5	TR 8	13,62	1	59S/TR8
3	TR8	8,17	1	59S/TR8-3P
5	TR 9	13,62	1	59S/TR9
3	TR9	8,17	1	59S/TR9-3P
5	TR 10	13,62	1	59S/TR10
3	TR 10	8,17	1	59S/TR10-3P
5	TR 15	13,62	1	59S/TR15
3	TR 15	8,17	1	59S/TR15-3P
5	TR 20	13,62	1	59S/TR20
3	TR 20	8,17	1	59S/TR20-3P
5	TR 25	13,62	1	59S/TR25
3	TR 25	8,17	1	59S/TR25-3P
5	TR 27	13,62	1	59S/TR27
3	TR 27	8,17	1	59S/TR27-3P
5	TR 30	13,62	1	59S/TR30
3	TR 30	8,17	1	59S/TR30-3P
5	TR 40	13,62	1	59S/TR40
3	TR 40	8,17	1	59S/TR40-3P

Pontas de aparafusadora standard 1/4" para parafusos de cabeça sextavada métrica de 25 mm



59S/H mm

X	Icon	€	Icon	Icon
5	1.5	13,19	1	59S/H1.5
3	1.5	7,93	1	59S/H1.5-3P
5	2	13,19	1	59S/H2
3	2	7,93	1	59S/H2-3P
5	2.5	13,19	1	59S/H2.5
3	2.5	7,93	1	59S/H2.5-3P
5	3	13,19	1	59S/H3
3	3	9,53	1	59S/H3-3P
5	4	13,19	1	59S/H4
3	4	9,53	1	59S/H4-3P
500	4	0,62	500	59S/H4-IPB
5	5	13,19	1	59S/H5
3	5	9,53	1	59S/H5-3P
5	6	13,19	1	59S/H6
3	6	9,53	1	59S/H6-3P
3	8	10,31	1	59S/H8-3P
5		17,17	1	59S/H8-5P
5	10	17,17	1	59S/H10
3	10	10,31	1	59S/H10-3P



Pontas de aparafusadora standard 1/4" para parafusos de cabeça sextavada imperial de 25 mm



59S/H "

X		€		
3	1/16 in	7,93	1	59S/H1/16-3P
5	5/16 in	13,19	1	59S/H5/16-5P
3	5/64 in	7,93	1	59S/H5/64-3P
5	5/64 in	13,19	1	59S/H5/64-5P
3	3/32 in	7,93	1	59S/H3/32-3P
5	3/32 in	13,19	1	59S/H3/32-5P
3	7/64 in	7,93	1	59S/H7/64-3P
5		13,19	1	59S/H7/64-5P
3	1/8 in	7,93	1	59S/H1/8-3P
5	1/8 in	13,19	1	59S/H1/8-5P
3	9/64 in	7,93	1	59S/H9/64-3P
3	5/32 in	7,93	1	59S/H5/32-3P
5	5/32 in	13,19	1	59S/H5/32-5P
3	3/16 in	7,93	1	59S/H3/16-3P
5	3/16 in	13,19	1	59S/H3/16-5P
3	7/32 in	7,93	1	59S/H7/32-3P
5	7/32 in	13,19	1	59S/H7/32-5P
3	1/4 in	7,93	1	59S/H1/4-3P
5	1/4 in	13,19	1	59S/H1/4-5P
3	5/16 in	7,93	1	59S/H5/16-3P
3	3/8 in	10,31	1	59S/H3/8-3P
5	3/8 in	7,93	1	59S/H3/8-5P

Pontas de aparafusadora standard 1/4" para parafusos Robertson de 25 mm



59S/R

X		€		
10	# 1	29,07	1	59S/R1
3	# 1	11,64	1	59S/R1-3P
10	# 2	29,07	1	59S/R2
3	# 2	11,64	1	59S/R2-3P
10	# 3	29,07	1	59S/R3
3	# 3	11,64	1	59S/R3-3P
10	# 4	29,07	1	59S/R4

Bit para parafusos TORQ-SET®, mm, 25mm



59S/TS

X		€		
5	0	36,33	1	59S/TS-0
5	1	36,33	1	59S/TS-1
5	2	36,33	1	59S/TS-2
5	3	36,33	1	59S/TS-3
5	4	36,33	1	59S/TS-4-5P
5	5	10,00	1	59S/TS-5-5P
5	6	36,33	1	59S/TS-6-5P
5	8	36,33	1	59S/TS-8-5P
5	10	36,33	1	59S/TS-10-5P

Pontas de aparafusadora standard imperial 1/4" para parafusos TORQ-SET® de 25 mm



59S/TS "

X		€		
5	1/4"	36,33	1	59S/TS-1/4

Bit para parafusos Tri-Wing, 25mm



59S/TW

X		€		
5	TW 0	33,03	1	59S/TW0
5	TW 1	33,03	1	59S/TW1
5	TW 2	33,03	1	59S/TW2
5	TW 3	33,03	1	59S/TW3
5	TW 4	33,03	1	59S/TW4
5	TW 5	33,03	1	59S/TW5

Pontas de aparafusadora standard 1/4" para parafusos XZN de 25 mm



59S/M

X		€		
10	M3	34,36	1	59S/M3
3	M3	10,31	1	59S/M3-3P
10	M4	34,36	1	59S/M4
3	M4	10,31	1	59S/M4-3P
10	M5	34,36	1	59S/M5
3	M5	10,31	1	59S/M5-3P
10	M6	34,36	1	59S/M6
3	M6	10,31	1	59S/M6-3P
10	M8	38,31	1	59S/M8
3	M8	11,49	1	59S/M8-3P

Pontas de aparafusadora standard 1/4" para parafusos de fenda de 50 mm



59S/50

X		€		
5	3.5 mm	17,17	1	59S/50/0.6-3.5
5	4.0 mm	17,17	1	59S/50/0.8-4.0
5	5.5 mm	17,17	1	59S/50/0.8-5.5
5	6.0 mm	17,17	1	59S/50/1.0-6.0
5	6.5 mm	17,17	1	59S/50/1.2-6.5
2	3.5 mm	6,87	1	59S/50/3.5-2P
2	4.0 mm	6,87	1	59S/50/4.0-2P
2	5.5 mm	6,87	1	59S/50/5.5-2P
2	6.0 mm	6,87	1	59S/50/6.0-2P
2	6.5 mm	6,87	1	59S/50/6.5-2P

Pontas de aparafusadora standard 1/4" para parafusos Phillips de 50 mm



59S/50PH

X		€		
5	1	13,88	1	59S/50PH1
2	1	6,88	1	59S/50PH1-2P
5	2	8,75	1	59S/50PH2-5P
2	2	6,88	1	59S/50PH2-2P
2	3	6,88	1	59S/50PH3-2P
5	3	13,88	1	59S/50PH3-5P

Pontas de aparafusadora standard 1/4" para parafusos Pozidriv de 50 mm



59S/50PZ

X	+	€		
2	1	6,88	1	59S/50PZ1-2P
2	2	6,88	1	59S/50PZ2-2P
5	2	13,88	1	59S/50PZ2-5P
2	3	6,88	1	59S/50PZ3-2P
5	3	13,88	1	59S/50PZ3-5P

Pontas de aparafusadora standard 1/4" para parafusos TORX® de 50 mm



59S/50T

X	T	€		
5	T 8	18,49	1	59S/50T8
2	T 8	9,78	1	59S/50T8-2P
5	T 10	18,49	1	59S/50T10
2	T 10	9,78	1	59S/50T10-2P
5	T 15	18,49	1	59S/50T15
2	T 15	9,78	1	59S/50T15-2P
5	T 20	9,30	1	59S/50T20-5P
2	T 20	9,78	1	59S/50T20-2P
5	T 25	18,49	1	59S/50T25
2	T 25	9,78	1	59S/50T25-2P
5	T 27	18,49	1	59S/50T27
5	T 30	18,49	1	59S/50T30
2	T 30	9,78	1	59S/50T30-2P
5	T 40	18,49	1	59S/50T40
2	T 40	9,78	1	59S/50T40-2P

Pontas de aparafusadora standard 1/4" para parafusos de cabeça sextavada métrica de 50 mm



59S/50H

X	H	€		
5	2	21,14	1	59S/50H2
2	2	5,28	1	59S/50H2-2P
5	2.5	8,75	1	59S/50H2.5-5P
2	2.5	5,28	1	59S/50H2.5-2P

X	H	€		
5	3	21,14	1	59S/50H3
2	3	5,28	1	59S/50H3-2P
5	4	8,75	1	59S/50H4-5P
2	4	5,28	1	59S/50H4-2P
5	5	8,75	1	59S/50H5-5P
2	5	5,28	1	59S/50H5-2P
5	6	21,14	1	59S/50H6
2	6	5,28	1	59S/50H6-2P
2	8	5,28	1	59S/50H8-2P
5	8	21,14	1	59S/50H8-5P

Bit para parafusos de cabeça sextavada em polegadas, 50mm, numa caixa de plástico com 5 pcs



59S/50H "

X	H	€		
5	1/1 in	20,48	1	59S/50H1/16
5	5/64 in	20,48	1	59S/50H5/64
5	3/32 in	20,48	1	59S/50H3/32
5	7/64 in	20,48	1	59S/50H7/64
5	1/8 in	20,48	1	59S/50H1/8
5	9/64 in	20,48	1	59S/50H9/64
5	5/32 in	20,48	1	59S/50H5/32
5	3/16 in	20,48	1	59S/50H3/16
5	7/32 in	20,48	1	59S/50H7/32
5	1/4 in	20,48	1	59S/50H1/4
5	5/16 in	20,48	1	59S/50H5/16
5	3/8 in	20,48	1	59S/50H3/8

Pontas de aparafusadora standard 1/4" para parafusos Robertson de 50 mm



59S/50R

X	R	€		
5	#1	27,74	1	59S/50R1
2	#1	11,11	1	59S/50R1-2P
5	#2	27,74	1	59S/50R2
2	#2	11,11	1	59S/50R2-2P
5	#3	27,74	1	59S/50R3
2	#3	11,11	1	59S/50R3-2P

Pontas de aparafusadora standard 1/4" para parafusos Phillips de 70 mm



59S/70PH

X	PH	€		
2	1	9,25	1	59S/70PH1-2P
2	2	9,25	1	59S/70PH2-2P
5	2	23,12	1	59S/70PH2-5P

Pontas de aparafusadora standard 1/4" para parafusos Pozidriv de 70 mm



59S/70PZ

X	PZ	€		
5	1	23,12	1	59S/70PZ1
2	1	9,25	1	59S/70PZ1-2P
5	2	23,12	1	59S/70PZ2
2	2	9,25	1	59S/70PZ2-2P
5	3	23,12	1	59S/70PZ3
2	3	9,25	1	59S/70PZ3-2P

Pontas de aparafusadora standard 1/4" para parafusos TORX® de 70 mm



59S/70T

X	T	€		
5	T10	27,74	1	59S/70T10
2	T10	11,11	1	59S/70T10-2P
5	T15	27,74	1	59S/70T15
2	T15	11,11	1	59S/70T15-2P
2	T20	11,11	1	59S/70T20-2P
5	T20	27,74	1	59S/70T20-5P
2	T25	11,11	1	59S/70T25-2P
5	T25	27,74	1	59S/70T25-5P
5	T27	27,74	1	59S/70T27
2	T27	11,11	1	59S/70T27-2P
2	T30	11,11	1	59S/70T30-2P
5	T30	27,74	1	59S/70T30-5P
5	T40	27,74	1	59S/70T40
2	T40	11,11	1	59S/70T40-2P



Pontas de aparafusadora standard 1/4" para parafusos TORX® invioláveis de 70 mm



59S/70TR

X	+	€		
5	TR15	40,95	1	59S/70TR15
2	TR15	16,37	1	59S/70TR15-2P
5	TR20	40,95	1	59S/70TR20
2	TR20	16,37	1	59S/70TR20-2P
5	TR25	40,95	1	59S/70TR25
2	TR25	16,37	1	59S/70TR25-2P
5	TR27	40,95	1	59S/70TR27
2	TR27	16,37	1	59S/70TR27-2P
5	TR30	40,95	1	59S/70TR30
2	TR30	16,37	1	59S/70TR30-2P
5	TR40	40,95	1	59S/70TR40
2	TR40	16,37	1	59S/70TR40-2P

Pontas de aparafusadora standard 1/4" para parafusos de esferas de cabeça sextavada de 89 mm



59S/H BALL

X	+	€		
5	3	40,95	1	59S/H3BALL
2	3	16,37	1	59S/H3BALL-2P
5	4	40,95	1	59S/H4BALL
2	4	16,37	1	59S/H4BALL-2P
5	5	40,95	1	59S/H5BALL
2	5	16,37	1	59S/H5BALL-2P
5	6	40,95	1	59S/H6BALL
2	6	16,37	1	59S/H6BALL-2P
5	8	40,95	1	59S/H8BALL
2	8	16,37	1	59S/H8BALL-2P
3	5,6,8	24,51	1	59S/HBALL-3P

Pontas de aparafusadora standard 1/4" para parafusos Phillips de 125 mm



59S/125PH

X	+	€		
5	1	34,36	1	59S/125PH1
2	1	13,74	1	59S/125PH1-2P
5	2	34,36	1	59S/125PH2
2	2	13,74	1	59S/125PH2-2P
100	2	2,58	100	59S/125PH2-1P
2	3	13,74	1	59S/125PH3-2P
5	3	34,36	1	59S/125PH3

Pontas de aparafusadora standard 1/4" para parafusos Pozidriv de 125 mm



59S/125PZ

X	+	€		
5	1	34,36	1	59S/125PZ1
2	1	13,74	1	59S/125PZ1-2P
5	2	34,36	1	59S/125PZ2
2	2	13,74	1	59S/125PZ2-2P
5	3	34,36	1	59S/125PZ3
2	3	13,74	1	59S/125PZ3-2P

Combinação de bit para parafusos de terminais (fenda/Phillips)



59S/PH COMBI

X	+	€		
2	5.0/PH1	16,37	1	59S/PH1COMBI-2P
2	6.0/PH2	16,37	1	59S/PH2COMBI-2P
2	8.0/PH3	16,37	1	59S/PH3COMBI-2P

Pontas de aparafusadora standard 1/4" para parafusos TORX® de 150 mm



59S/150T

X	+	€		
5	T15	51,53	1	59S/150T15
2	T15	20,61	1	59S/150T15-2P
5	T20	51,53	1	59S/150T20
2	T20	20,61	1	59S/150T20-2P
5	T25	51,53	1	59S/150T25
2	T25	20,61	1	59S/150T25-2P
5	T30	51,53	1	59S/150T30
2	T30	20,61	1	59S/150T30-2P

Bit. Sextavado



74S/H

X	+	€		
5	4 mm	42,45	1	74S/H4
2	4 mm	16,98	1	74S/H4-2P
5	5 mm	42,45	1	74S/H5
2	5 mm	16,98	1	74S/H5-2P
5	6 mm	42,45	1	74S/H6
2	6 mm	16,98	1	74S/H6-2P
5	7 mm	42,45	1	74S/H7
2	7 mm	16,98	1	74S/H7-2P
5	8 mm	42,45	1	74S/H8
2	8 mm	16,98	1	74S/H8-2P
5	10 mm	42,45	1	74S/H10
2	10 mm	16,98	1	74S/H10-2P
5	12 mm	56,56	1	74S/H12
2	12 mm	22,62	1	74S/H12-2P
5	14 mm	56,56	1	74S/H14
2	14 mm	22,62	1	74S/H14-2P
5	17 mm	56,56	1	74S/H17
2	17 mm	22,62	1	74S/H17-2P

Bit, PHILLIPS®



45S/PH

		€		
5	1	16,89	1	45S/PH1
2	1	6,75	1	45S/PH1-2P
5	2	18,93	1	45S/PH2
2	2	7,57	1	45S/PH2-2P

Bit, Hexagonal



45S/H

		€		
5	1.5 mm	17,56	1	45S/H1.5
2	1.5 mm	7,02	1	45S/H1.5-2P
5	2 mm	17,56	1	45S/H2
2	2 mm	7,02	1	45S/H2-2P
5	2.5 mm	17,56	1	45S/H2.5
2	2.5 mm	7,02	1	45S/H2.5-2P
5	3 mm	17,56	1	45S/H3
2	3 mm	7,02	1	45S/H3-2P

Conjunto de 7peças de bits para parafusos Pozidriv, Phillips e TORX® e suporte para bits



59S/7-1

		€		
7	22 x 65 x 75 mm	12,39	1	59S/7-1

59S/PH1, 59S/PH2		
59S/PZ1, 59S/PZ2		
59S/T15, 59S/T20		

Conjunto de 7peças de bits para parafusos Phillips e TORX® e suporte de bits



59S/7-2

		€		
7	22 x 65 x 75 mm	13,08	1	59S/7-2

59S/PH2		
59S/T15x 2, 59S/T20x 2, 59S/T25		

Conjunto de 7peças de bits para parafusos TORX® de segurança e suporte para bits



59S/7-3

		€		
7	22 x 65 x 75 mm	23,19	1	59S/7-3

59S/TR10, 59S/TR15, 59S/TR20, 59S/TR25, 59S/TR30, 59S/TR40		
--	--	--

Conjunto de 7peças de bits para parafusos TORX® e suporte para bits



59S/7-4

		€		
7	22 x 65 x 75 mm	13,54	1	59S/7-4

59S/T10, 59S/T15, 59S/T20, 59S/T25, 59S/T30, 59S/T40		
--	--	--

Conjunto de pontas 1/4" para parafusos Phillips/Pozidriv/TORX® num suporte plástico com presilha para cinto - 10 peças



59S/10BC

		€		
10	23 x 68 x 168 mm	4,52	1	59S/10BC

Conjunto de pontas cónicas 1/4" para parafusos TORX® - 11 peças



59S/TCS11-1

		€		
11	108 x 68 x 31 mm	18,48	1	59S/TCS11-1

59S/T10CS, 59S/T15CS, 59S/T20CSx 3, 59S/T25CSx 2, 59S/T30CSx 2, 59S/T40CS		
KM653-QR-1P		

Conjunto de 17peças de bits para parafusos de fenda, Pozidriv, Phillips e hexagonais com suporte de bit com sistema de libertação rápida



59S/17-1

		€		
17	27 x 73 x 82 mm	21,69	1	59S/17-1

59S/0.5-3.0, 59S/0.6-4.5, 59S/0.8-5.5		
59S/PH1, 59S/PH2x 3		
59S/PH2Gx 2		
59S/PZ1, 59S/PZ2x 2		
59S/H3, 59S/H4, 59S/H5, 59S/H6		



Conjunto de 17 peças de bits para parafusos TORX® e suporte



59S/17-2

		€		
17	27 x 73 x 82 mm	22,67	1	59S/17-2

59S/T7, 59S/T8, 59S/T9, 59S/T10, 59S/T15x 2, 59S/T20x 3, 59S/T25x 3, 59S/T27, 59S/T30x 2, 59S/T40

Conjunto de 17 peças de bits para parafusos Pozidriv, Phillips, TORX® de segurança, hexagonais e suporte



59S/17-3

		€		
17	27 x 73 x 82 mm	21,99	1	59S/17-3

59S/PH1, 59S/PH2x 2
59S/PZ1, 59S/PZ2, 59S/PZ3
59S/T10, 59S/T15, 59S/T20, 59S/T25, 59S/T27, 59S/T30, 59S/T40
59S/H3, 59S/H4, 59S/H5

Conjunto de bits 22 peças para parafusos de fenda, Phillips, Pozidriv, TORX®, com suporte e adaptador 1/4"



59S/22-1

		€		
22	20 x 50 x 80 mm	30,77	1	59S/22-1

59S/0.5-3.0, 59S/0.6-4.5, 59S/0.8-5.5	
59S/PH1, 59S/PH2, 59S/PH3	
59S/PH2G	
59S/PZ1, 59S/PZ2, 59S/PZ3	
59S/T6, 59S/T8, 59S/T9, 59S/T10, 59S/T15, 59S/T20, 59S/T25, 59S/T27, 59S/T30, 59S/T40	
K6650-1/4	

Conjunto de bits 22 peças para parafusos Phillips, TORX®, hexagonais com suporte e adaptador 1/4"



59S/22-2

		€		
22	20 x 50 x 80 mm	30,77	1	59S/22-2

59S/PH2x 3	
59S/PH2Gx 3	
59S/PZ2x 2	
59S/T10, 59S/T15x 4, 59S/T20x 3, 59S/T25x 2	
59S/H2.5, 59S/H3	
K6650-1/4	

Conjunto com 28 bits e adaptador com adaptadores. Fenda, PHILLIPS®, TORX®, hexagonal, Torq-Set



59S/28

		€		
28	30 x 58 x 110 mm	117,33	1	59S/28-4

Fenda, PHILLIPS®, TORX®, hexagonal, Torq-Set

59S/0.6-4.5, 59S/1.2-6.5, 59S/1.2-8.0	
59S/PH1x 2, 59S/PH2x 2, 59S/PH3	
59S/T6, 59S/T15	
59S/H5/64, 59S/H3/32, 59S/H7/64, 59S/H1/8, 59S/H5/32, 59S/H3/16, 59S/H7/32, 59S/TS-4x 2, 59S/TS-6x 2, 59S/TS-8x 2, 59S/TS-10x 2, K6625-1/4, KM653	
59S/H9/64	

Conj. bits 31 pcs para fenda, Phillips, Pozidriv, TORX® e sextavados, porta-bits e adaptador de chave de caixa de 1/4"



59S/31B

		€		
31	40.25 x 104.90 x 65.35 mm	15,71	1	59S/31B

59S/0.6-4.5, 59S/1.0-5.5	
59S/PH1, 59S/PH2x 3, 59S/PH3	
59S/PH2Gx 2	
59S/PZ1, 59S/PZ2x 3, 59S/PZ3	
59S/T10, 59S/T15x 3, 59S/T20x 3, 59S/T25x 2, 59S/T27, 59S/T30	
59S/H3, 59S/H4, 59S/H5, 59S/H6	
K6625-1/4-1P	
KM653-QR-1P	

Conj. bits 31 pcs para fenda, Phillips, Pozidriv, TORX® e sextavados, porta-bits e adaptador de chave de caixa de 1/4"



59S/31B-IP

		€		
12	280 x 375 x 210 mm	15,40	12	59S/31B-IP

Conjunto com 30 bits e adaptador. Fenda, PHILLIPS®, POZIDRIV®, TORX®, hexagonal e adaptador



59S/31-1

		€		
31	42 x 65 x 110 mm	24,04	1	59S/31-1

Fenda, PHILLIPS®, POZIDRIV®, TORX®, hexagonal e adaptador

59S/0.5-3.0, 59S/0.6-4.5, 59S/0.8-5.5		
59S/PH1, 59S/PH2x 3, 59S/PH3		
59S/PH2Gx 2		
59S/PZ1, 59S/PZ2x 3, 59S/PZ3		
59S/T10, 59S/T15x 3, 59S/T20x 3, 59S/T25x 2, 59S/T27, 59S/T30		
59S/H3, 59S/H4, 59S/H5, 59S/H6		
66IM/KM75QR-1P		

Conjunto de bits 31 peças para parafusos Phillips, Pozidriv, TORX® e suporte



59S/31-2

		€	
31	42 x 65 x 110 mm	24,72	1 59S/31-2

59S/PH2x 4		
59S/PH2Gx 4		
59S/PZ2x 4		
59S/T10x 2, 59S/T15x 4, 59S/T20x 5, 59S/T25x 5, 59S/T30x 2		
KM653-QR-1P		

Conjunto de bits 31 peças para parafusos Phillips, Pozidriv, TORX® de segurança e suporte para bits



59S/31-3

		€	
31	42 x 65 x 110 mm	28,88	1 59S/31-3

59S/PH1x 2, 59S/PH2x 2, 59S/PH3		
59S/PZ1x 2, 59S/PZ2x 2, 59S/PZ3		
59S/TR10x 2, 59S/TR15x 3, 59S/TR20x 5, 59S/TR25x 4, 59S/TR27, 59S/TR30x 4, 59S/TR40		
KM653-QR-1P		

Conjunto de pontas para trabalhos pesados de 1/4" para pontas TORX® e chaves de porcas - 35 peças



59/S35BC

		€	
35	50 x 110 x 180 mm	64,35	1 59/S35BC

Conj. 54 bits p/paraf. fenda, Phillips, Pozidriv, hex, Robertson e TORX® colorido, TORX® segurança



59/S54BC

		€	
54	50 x 110 x 184 mm	34,56	1 59/S54BC

Os bits TORX são coloridos para a fácil identificação do tamanho da ponta

Conj. 54 bits p/paraf. fenda, Phillips, Pozidriv, hex, Robertson e TORX® col., TORX® seg., em cx expos. 8 pçs



59/S54BC-IP

		€	
54	300 x 190 x 280 mm	34,56	8 59/S54BC-IP

Os bits TORX são coloridos para a fácil identificação do tamanho da ponta

Conj. 100 bits p/paraf. fenda, Phillips, Pozidriv, hex, Robertson e TORX® col., TORX® segurança



59/S100BC

		€	
100	50 x 110 x 184 mm	45,25	1 59/S100BC

Os bits TORX são coloridos

Conj. 100 bits p/paraf. fenda, Phillips, Pozidriv, hex, Robertson e TORX® col., TORX® segurança



59/S100BC-IP

		€	
100	300 x 190 x 280 mm	45,25	8 59/S100BC-IP

Os bits TORX são coloridos



Jogo de chaves de caixa e bits. Roquete para bits e adaptadores



2058/S26

Qtd	Dimensões	Preço	Ref
26	80 x 100 x 35 mm	37,76	1 2058/S26
26	35 x 85 x 105 mm	35,15	1 SB-2058/S26

SB = Em embalagem individual num cartão informativo de plástico

2058-BR	
K6625-1/4-1P	
59S/H6, 59S/H5, 59S/H4, 59S/H3	
59S/T15, 59S/T10, 59S/T30, 59S/T25, 59S/T20	
59S/PZ3, 59S/PZ1, 59S/PZ2	
59S/PH1, 59S/PH2, 59S/PH3	
59S/0.8-5.5, 59S/0.5-4.0	
6700SM-8, 6700SM-7, 6700SM-6, 6700SM-13, 6700SM-10	
59S/1.0-6.0-IP	
KM753-QR-1P	

Jogo de bits e chave de caixas padrão de 1/4" para parafusos com fenda/Phillips/Pozidriv/TORX®/cabeça sextavada - 26 peças



2058/S26AF

Qtd	Dimensões	Preço	Ref
26	80 x 100 x 35 mm	24,22	1 2058/S26AF

Jogo de chaves de caixa e pontas. Roquete para bits y adaptadores



2058/S26-2

Qtd	Dimensões	Preço	Ref
1	80 x 100 x 35 mm	37,77	1 2058/S26-2

Roquete para bits y adaptadores

2058-BR	
6700SM-8, 6700SM-7, 6700SM-6, 6700SM-5, 6700SM-4	
K6625-1/4B-1P, KM653-QR-1P	
59S/0.5-3.0, 59S/0.8-5.5, 59S/0.5-4.0	
59S/T8, 59S/T7, 59S/T6, 59S/T5, 59S/T4	
59S/PZ1, 59S/PZ0, 59S/PZ2	
59S/H2, 59S/H2.5, 59S/H1.5, 59S/H3	
59S/PH1, 59S/PH0, 59S/PH2	

Conjunto de pontas de aparafusadora standard 1/4" para parafusos PH2 de 25 mm - 5 peças



59S/PH2PEN

Qtd	Dimensões	Preço	Ref
5	13 x 17 x 132 mm	3,07	1 59S/PH2PEN

Conjunto de pontas de aparafusadora standard 1/4" para parafusos PZ2 de 25 mm - 5 peças



59S/PZ2PEN

Qtd	Dimensões	Preço	Ref
5	13 x 17 x 132 mm	3,07	1 59S/PZ2PEN

Conjunto de pontas de chave de parafusos standard 1/4" para parafusos TORX® invioláveis T15 de 25 mm - 5 peças



59S/TORXPEN

Qtd	Dimensões	Preço	Ref
5	13 x 17 x 132 mm	3,58	1 59S/T15PEN
5	13 x 17 x 132 mm	3,58	1 59S/T20PEN
5	13 x 17 x 132 mm	3,58	1 59S/T25PEN

Conjunto de chaves de caixa com ponta 1/4" para parafusos Phillips/Pozidriv/TORX® - 60 peças/expositor de balcão



59S/60PEN/DISP

Qtd	Dimensões	Preço	Ref
60	140 x 125 x 215 mm	184,31	1 59S/60PEN/DISP

59S/T15PENx 5, 59S/T20PENx 30, 59S/T25PENx 5	
59S/PH2PENx 10	
59S/PZ2PENx 10	

Bit. Fenda



70S/

Qtd	Dimensões	Preço	Ref
2	8.0 mm	8,38	1 70S/1.2-8.0-2P
5	9.0 mm	20,95	1 70S/1.6-9.0
2	9.0 mm	8,38	1 70S/1.6-9.0-2P
5	10.0 mm	29,75	1 70S/1.6-10.0
2	10.0 mm	11,90	1 70S/1.6-10.0-2P

X	Ø	€		
5	12.0 mm	32,51	1	70S/2.0-12.0
2	12.0 mm	13,00	1	70S/2.0-12.0-2P
5	14.0 mm	36,68	1	70S/2.5-14.0
2	14.0 mm	14,68	1	70S/2.5-14.0-2P

Bit. PHILLIPS®



70S/PH

X	+	€		
5	1	18,41	1	70S/PH1
2	1	7,37	1	70S/PH1-2P
5	2	18,41	1	70S/PH2
2	2	7,37	1	70S/PH2-2P
5	3	18,41	1	70S/PH3
2	3	7,37	1	70S/PH3-2P
5	4	18,41	1	70S/PH4
2	4	7,37	1	70S/PH4-2P

Bit. POZIDRIV®



70S/PZ

X	+	€		
5	1	18,41	1	70S/PZ1
2	1	7,37	1	70S/PZ1-2P
5	2	18,41	1	70S/PZ2
2	2	7,37	1	70S/PZ2-2P
5	3	18,41	1	70S/PZ3
2	3	7,37	1	70S/PZ3-2P
5	4	18,41	1	70S/PZ4
2	4	7,37	1	70S/PZ4-2P

Bit. TORX®



70S/T

X	*	€		
5	T25	23,08	1	70S/T25-5P
5	T20	23,08	1	70S/T20
2	T20	9,23	1	70S/T20-2P

X	*	€		
2	T25	9,23	1	70S/T25-2P
5	T27	10,75	1	70S/T27-5P
2	T27	9,23	1	70S/T27-2P
5	T30	23,08	1	70S/T30
2	T30	9,23	1	70S/T30-2P
2	T40	9,23	1	70S/T40-2P
5	T45	23,08	1	70S/T45
2	T45	9,23	1	70S/T45-2P
5	T50	23,08	1	70S/T50
2	T50	9,23	1	70S/T50-2P
5	T55	31,94	1	70S/T55
2	T55	12,76	1	70S/T55-2P

Bit. TORQ-SET®



70S/TS

X		€		
5	8 mm	43,13	1	70S/TS8
2	8 mm	17,25	1	70S/TS8-2P
5	10 mm	43,13	1	70S/TS10
2	10 mm	17,25	1	70S/TS10-2P

Pontas para aparafusadora de impacto imperial 5/16" para parafusos TORQ-SET® de 32 mm



70S/TS"

X		€		
5	1/4"	38,46	1	70S/TS1/4
2	1/4"	15,38	1	70S/TS1/4-2P
5	5/16"	43,13	1	70S/TS5/16
2	5/16"	17,25	1	70S/TS5/16-2P

Bit. Sextavado



70S/H

X	Ø	€		
5	4 mm	18,41	1	70S/H4
2	4 mm	7,37	1	70S/H4-2P
5	5 mm	18,41	1	70S/H5
2	5 mm	7,37	1	70S/H5-2P
5	6 mm	18,41	1	70S/H6
2	6 mm	7,37	1	70S/H6-2P
5	7 mm	18,41	1	70S/H7
2	7 mm	7,37	1	70S/H7-2P
5	8 mm	8,72	1	70S/H8-5P
2	8 mm	7,37	1	70S/H8-2P
5	10 mm	22,26	1	70S/H10
2	10 mm	8,90	1	70S/H10-2P
5	12 mm	23,71	1	70S/H12
2	12 mm	9,47	1	70S/H12-2P
5	14 mm	23,71	1	70S/H14
2	14 mm	9,47	1	70S/H14-2P

Chave de impacto 5/16"



5521

L	€		
125 mm	53,14	1	5521

Adaptador de chave de impacto, 5/16" bits



54640

L	€		
40 mm	19,58	1	54640



Conjunto sortido de bits para parafusos Phillips, fenda, hexagonais e TORX®



7823

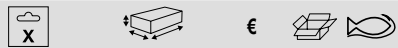

23 45 x 70 x 197 mm 75,46 1 7823

5521

54640

70S/1.2-8.0, 70S/1.6-10.0, 70S/2.0-12.0

70S/PH2, 70S/PH3, 70S/PH4

70S/T20, 70S/T25, 70S/T27, 70S/T30, 70S/T40, 70S/T45, 70S/T50, 70S/T55

70S/H4, 70S/H5, 70S/H6, 70S/H7, 70S/H8, 70S/H10, 70S/H12, 70S/H14

Conjunto com 30 bits e adaptador. Fenda, PHILLIPS®, POZIDRIV®, TORX®, hexagonal e adaptador



7865

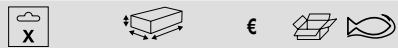

15 55 x 90 x 220 mm 43,82 1 7865

Fenda, PHILLIPS®, POZIDRIV®, TORX®, hexagonal e adaptador

5521

54640

70S/1.2-8.0, 70S/1.6-10.0

70S/PH1, 70S/PH2, 70S/PH3, 70S/PH4

70S/H4, 70S/H5, 70S/H6, 70S/H8

Bits, encabadouro com rosca. PHILLIPS®



K18



1	2	7,54	1	K18NF-2
1	2	8,37	1	K18PH-2M5
1	2	8,41	1	K18PH-2M6

PHILLIPS®

Bits, encabadouro com rosca. POZIDRIV®



K19PZD-2NF

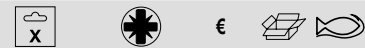

1	2	7,54	1	K19PZD-2NF
1	2	7,54	1	K19PZD-2M5

POZIDRIV®

Bits, encabadouro com rosca. TORX®



K20TORX



1	T25	10,66	1	K20TORX-T25
---	-----	-------	---	-------------

TORX®

Adaptador para bits, 50mm



K6750

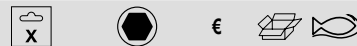

1	1/4 in	6,08	1	K6750-6
1	1/4 in	6,08	1	K6750-7
1	1/4 in	6,08	1	K6750-10-1P
1	1/4 in	6,08	1	K6750-13
1	1/4 in	6,08	1	K6750-1/4
1	1/4 in	6,08	1	K6750-3/8

Adaptador magnético para bits, 50mm



KM6750



1		7,41	1	KM6750-6
1		7,41	1	KM6750-7
1		7,41	1	KM6750-10-1P
1		7,41	1	KM6750-11
1		7,41	1	KM6750-13-1P
1		7,41	1	KM6750-1/4
1		7,41	1	KM6750-3/8

Adaptador com ímã permanente e mola de pinça. KM653-QR em caixa de plástico com 5 pcs e KM653-QR-1 em suporte de plástico por unidade



KM653-QR



1	1/4"	15,31	1	KM653-QR-1P
5	1/4"	65,95	1	KM653-QR-5P

KM653-QR em caixa de plástico com 5 pcs e KM653-QR-1 em suporte de plástico por unidade

Porta-bits magnético com sistema de libertação rápida, 75mm. Em suporte de plástico por unidade



KM753-QR

		€		
1	1/4 in	17,17	1	KM753-QR-1P

Em suporte de plástico por unidade

Porta-bits de chave de fendas de torção com 1/4" para serviço pesado



KMT753-QR-1P

		€		
1/4 in	1/4 in	10,23	1	KMT753-QR-1P

Adaptador 1/4" articulado. Em suporte de plástico por unidade



Adaptador universal 1/4" com anel de retenção



KR653

		€		
1	1/4 in	5,84	1	KR653-1P
5	1/4 in	29,19	1	KR653

Adaptador com íman permanente e mola de pinça. KM653 em caixa de plástico com 5 pcs e KM653-1P em suporte de plástico por unidade



KM653

		€		
1	1/4"	6,00	1	KM653-1P
5	1/4"	30,02	1	KM653-5P

KM653 em caixa de plástico com 5 pcs e KM653-1P em suporte de plástico por unidade

Adaptador universal magnético 1/4" com anel retentor - 60mm. KMR653 em caixa de plástico com 5 pcs e KMR653-1P em suporte de plástico por unidade



KMR653

		€		
1	1/4 in	8,99	1	KMR653-1P
5	1/4 in	25,93	1	KMR653-5P

KMR653 em caixa de plástico com 5 pcs e KMR653-1P em suporte de plástico por unidade

Adaptador universal magnético 1/4" com anel retentor - 75mm



KMR753

		€		
1	1/4 in	8,23	1	KMR753-1P
5	1/4 in	41,22	1	KMR753

Adaptador universal 1/4" com anel de retenção em cobre-berílio. Em suporte de plástico por unidade



KCB753

		€		
1	1/4 in	46,16	1	KCB753

Em suporte de plástico por unidade

Adaptador universal magnético 1/4" com anel retentor - 150mm. KMR150 em caixa de plástico com 5 pcs e KMR150-1P em suporte de plástico por unidade



KMR150

		€		
1	1/4 in	15,79	1	KMR150-1P
5	1/4 in	68,69	1	KMR150

KMR150 em caixa de plástico com 5 pcs e KMR150-1P em suporte de plástico por unidade



Suporte magnético de bits, 70mm. Em suporte de plástico (1 pc)



KM1/4-5/16-1P

Quantidade	Tamanho	Preço	Unidades	Modelo
1	1/4 in	6,79	1	KM1/4-5/16-1P

Em suporte de plástico (1 pc)

Adaptador hexagonal 1/4' e quadrado 1/4', 25mm



K6625

Quantidade	Tamanho	Preço	Unidades	Modelo
1	1/4 in	5,29	1	K6625-1/4-1P
5		26,45	1	K6625-1/4B-5P

Adaptador hexagonal 1/4' e quadrado 3/8', 38mm



K6638

Quantidade	Tamanho	Preço	Unidades	Modelo
1	1/4 in	6,19	1	K6638-3/8-1P
5	1/4 in	30,91	1	K6638-3/8

Adaptador hexagonal e quadrado, 50mm. K6650-1/4-1P é embalado por unidade



K6650

Quantidade	Tamanho	Preço	Unidades	Modelo
1		8,74	1	K6650-1/4B-1P
5		43,61	1	K6650-1/4P-5P
1	1/4 in	11,68	1	K6650-3/8-1P
5		58,40	1	K6650-3/8P-5P
1	1/4 in	14,42	1	K6650-1/2-1P
5		72,14	1	K6650-1/2P-5P

K6650-1/4-1P é embalado por unidade

Adaptador hexagonal e quadrado, 100mm



K66100

Quantidade	Tamanho	Preço	Unidades	Modelo
1	1/4 in	10,86	1	K66100-1/4-1P
5	1/4 in	54,27	1	K66100-1/4
1	1/4 in	13,74	1	K66100-3/8-1P
5	1/4 in	68,69	1	K66100-3/8

Adaptador 1/4' com sistema de liberação rápida, 60mm



K6660-QR

Quantidade	Tamanho	Preço	Unidades	Modelo
1	1/4 in	14,15	1	K6660-QR-1P

CHAVES DE IMPACTO DE

Chave de impacto, 6 faces



K6701M

Tamanho	Preço	Unidades	Modelo
6 mm	7,35	1	K6701M-6
7 mm	7,35	1	K6701M-7
8 mm	7,39	1	K6701M-8
9 mm	7,39	1	K6701M-9
10 mm	7,39	1	K6701M-10
11 mm	7,39	1	K6701M-11
12 mm	9,21	1	K6701M-12
13 mm	9,21	1	K6701M-13
14 mm	9,21	1	K6701M-14

Chaves de caixa de impacto quadradas 1/4" com perfil sextavado no sistema métrico e acabamento fosfatado - Conjunto de venda a retalho



SBK6701M

Tamanho	Preço	Unidades	Modelo
6 mm	7,35	1	SBK6701M-6
7 mm	7,35	1	SBK6701M-7
8 mm	7,35	1	SBK6701M-8
9 mm	7,35	1	SBK6701M-9
10 mm	7,35	1	SBK6701M-10
11 mm	7,35	1	SBK6701M-11
12 mm	9,11	1	SBK6701M-12
13 mm	9,11	1	SBK6701M-13
14 mm	9,11	1	SBK6701M-14

Chave de caixa magnética



KM6701M

Ø	€		
7 mm	31,56	1	KM6701M-7
8 mm	31,95	1	KM6701M-8
10 mm	32,96	1	KM6701M-10

Freio de segurança



K560F-1

Ø	Ø	€	
1/4 in	6-14 mm	3,24	5 K560F-1

Chave de impacto, 6 faces



K7401M

Ø	€		
7 mm	8,70	1	K7401M-7
8 mm	8,70	1	K7401M-8
9 mm	8,70	1	K7401M-9
10 mm	8,70	1	K7401M-10
11 mm	8,70	1	K7401M-11
12 mm	8,70	1	K7401M-12
13 mm	8,70	1	K7401M-13
14 mm	8,70	1	K7401M-14
15 mm	8,70	1	K7401M-15
16 mm	8,70	1	K7401M-16
17 mm	8,70	1	K7401M-17
18 mm	10,34	1	K7401M-18

Ø	€		
19 mm	10,34	1	K7401M-19
20 mm	10,63	1	K7401M-20
21 mm	10,63	1	K7401M-21
22 mm	11,12	1	K7401M-22
24 mm	11,29	1	K7401M-24

Chaves de caixa de impacto quadradas 3/8" com perfil sextavado no sistema métrico e acabamento fosfatado - Conjunto de venda a retalho



SBK7401M

Ø	€		
7 mm	8,41	1	SBK7401M-7
8 mm	8,41	1	SBK7401M-8
9 mm	8,41	1	SBK7401M-9
10 mm	8,41	1	SBK7401M-10
11 mm	8,41	1	SBK7401M-11
12 mm	8,41	1	SBK7401M-12
13 mm	8,41	1	SBK7401M-13
14 mm	8,41	1	SBK7401M-14
15 mm	8,41	1	SBK7401M-15
16 mm	8,41	1	SBK7401M-16
17 mm	8,41	1	SBK7401M-17
18 mm	9,88	1	SBK7401M-18
19 mm	9,88	1	SBK7401M-19
20 mm	10,17	1	SBK7401M-20
21 mm	10,17	1	SBK7401M-21
22 mm	10,62	1	SBK7401M-22
24 mm	10,71	1	SBK7401M-24

Chave de impacto série longa, 6 faces



K7406M

Ø	€		
10 mm	9,73	1	K7406M-10
13 mm	11,05	1	K7406M-13
17 mm	12,05	1	K7406M-17

Chaves de impacto sextavadas de 3/8", em polegadas



K7401Z

Ø	€		
3/8 in	9,17	1	K7401Z-3/8
7/16 in	9,17	1	K7401Z-7/16
1/2 in	9,17	1	K7401Z-1/2
9/16 in	9,17	1	K7401Z-9/16
5/8 in	9,17	1	K7401Z-5/8
11/16 in	9,17	1	K7401Z-11/16
3/4 in	9,17	1	K7401Z-3/4
13/16 in	9,17	1	K7401Z-13/16
7/8 in	9,17	1	K7401Z-7/8

Porta-bits de 1/4" para adaptador de potência de 3/8"



K172

Ø	€		
1/4"	32,66	1	K172

Adaptador para bits aparafusadora. Com macho sextavado de 11mm



7407H-7409H

Ø	Ø	€	
1/4"	3/8"	25,23	1 7407H
5/16"	3/8"	25,23	1 7408H
11	3/8"	29,24	1 7409H

Com macho sextavado de 11mm



Chaves de caixa, 3/8", TORX®



K7401TORX-E

Model	Size	Price (€)	Quantity	Part No.
E5	M4	11,42	1	K7401TORX-E5
E6	M5	11,42	1	K7401TORX-E6
E7	M6	11,42	1	K7401TORX-E7
E8	M6, M7	11,42	1	K7401TORX-E8
E10	M6, M8	11,42	1	K7401TORX-E10
E12	M8, M10	11,42	1	K7401TORX-E12
E14	M10, M12	11,42	1	K7401TORX-E14

Chaves de caixa articuladas elétricas sextavadas de 3/8" em tamanhos métricos, mm



KS7401M

Size	Price (€)	Quantity	Part No.
3/8 in	33,54	1	KS7401M-9
3/8 in	33,54	1	KS7401M-10
3/8 in	33,54	1	KS7401M-11
3/8 in	33,54	1	KS7401M-12
3/8 in	33,54	1	KS7401M-13
3/8 in	34,67	1	KS7401M-14
3/8 in	34,67	1	KS7401M-15
3/8 in	34,67	1	KS7401M-16
3/8 in	34,67	1	KS7401M-17
3/8 in	34,67	1	KS7401M-18
3/8 in	34,67	1	KS7401M-19
3/8 in	37,42	1	KS7401M-22

Cardan



K7767S

Size	Price (€)	Quantity	Part No.
3/8"	33,88	1	K7767S

Adaptador extensor de 3/8" a 1/2"



K6964C

Size	Price (€)	Quantity	Part No.
1/4"	23,20	1	K6964C

Adaptadores de chaves quadradas de 3/8" com acabamento em fosfato



K8164C

Size	Price (€)	Quantity	Part No.
1/2"	23,20	1	K8164C

Extensão



K7760C

Length	Price (€)	Quantity	Part No.
75 mm	16,02	1	K7760C-1
150 mm	23,03	1	K7760C-2

Freio de segurança



K560F-2/3

Size	Range	Price (€)	Quantity	Part No.
3/8"	7-12	3,24	5	K560F-2
3/8"	13-24	3,24	5	K560F-3

Conjunto de chaves de caixa sextavadas de impacto com perfil sextavado no sistema métrico - 10 peças



K7401M/10

Quantity	Price (€)	Quantity	Part No.
10	86,46	1	K7401M/10

K7401M-10, K7401M-11, K7401M-12, K7401M-13, K7401M-14, K7401M-15, K7401M-16, K7401M-17, K7401M-18, K7401M-19



Conjunto de encaixes de 3/8", E TORX®,
7 peças



K7401TORX-E-S7

	€		
7	79,96	1	K7401TORX-E-S7

K7401TORX-E5, K7401TORX-E6,
K7401TORX-E7, K7401TORX-E8,
K7401TORX-E10, K7401TORX-E12,
K7401TORX-E14

Chave de impacto ultracurta



K7800M

Ø	€		
10 mm	6,35	1	K7800M-10
11 mm	6,35	1	K7800M-11
12 mm	6,35	1	K7800M-12
13 mm	6,35	1	K7800M-13
14 mm	6,46	1	K7800M-14
15 mm	6,46	1	K7800M-15
16 mm	6,46	1	K7800M-16
17 mm	6,75	1	K7800M-17
18 mm	6,75	1	K7800M-18
19 mm	6,75	1	K7800M-19
21 mm	6,75	1	K7800M-21
22 mm	6,86	1	K7800M-22
24 mm	7,42	1	K7800M-24

Chave de impacto, 6 faces



K7801M

Ø	€		
8 mm	6,08	1	K7801M-8
9 mm	6,08	1	K7801M-9
10 mm	10,29	1	K7801M-10
11 mm	10,29	1	K7801M-11
12 mm	10,29	1	K7801M-12
13 mm	10,29	1	K7801M-13
14 mm	10,65	1	K7801M-14
15 mm	10,86	1	K7801M-15
16 mm	10,86	1	K7801M-16
17 mm	11,37	1	K7801M-17
18 mm	11,37	1	K7801M-18
19 mm	11,37	1	K7801M-19
20 mm	11,99	1	K7801M-20
21 mm	12,06	1	K7801M-21
22 mm	12,20	1	K7801M-22
23 mm	12,57	1	K7801M-23
24 mm	12,76	1	K7801M-24
25 mm	14,77	1	K7801M-25
26 mm	15,18	1	K7801M-26
27 mm	15,18	1	K7801M-27
28 mm	15,18	1	K7801M-28
29 mm	15,34	1	K7801M-29
30 mm	18,60	1	K7801M-30
32 mm	26,64	15	K7801M-32
34 mm	30,09	1	K7801M-34
36 mm	31,10	1	K7801M-36

Chaves de caixa de impacto quadradas
1/2" com perfil sextavado no sistema
métrico e acabamento fosfatado -
Conjunto de venda a retalho



SBK7801M

Ø	€		
8 mm	7,98	1	SBK7801M-8
9 mm	7,98	1	SBK7801M-9
10 mm	10,05	1	SBK7801M-10
11 mm	10,05	1	SBK7801M-11

Ø	€		
12 mm	10,05	1	SBK7801M-12
13 mm	10,05	1	SBK7801M-13
14 mm	10,40	1	SBK7801M-14
15 mm	10,40	1	SBK7801M-15
16 mm	10,40	1	SBK7801M-16
17 mm	11,38	1	SBK7801M-17
18 mm	11,38	1	SBK7801M-18
19 mm	11,38	1	SBK7801M-19
20 mm	11,38	1	SBK7801M-20
21 mm	11,38	1	SBK7801M-21
22 mm	12,20	1	SBK7801M-22
23 mm	12,24	1	SBK7801M-23
24 mm	12,24	1	SBK7801M-24
25 mm	12,24	1	SBK7801M-25
26 mm	12,24	1	SBK7801M-26
27 mm	15,20	1	SBK7801M-27
28 mm	14,55	1	SBK7801M-28
29 mm	14,63	1	SBK7801M-29
30 mm	16,53	1	SBK7801M-30
32 mm	23,69	1	SBK7801M-32
34 mm	25,75	1	SBK7801M-34
36 mm	25,75	1	SBK7801M-36

Chave de impacto série longa, 6 faces



K7806M

Ø	€		
10 mm	12,54	1	K7806M-10
11 mm	12,54	1	K7806M-11
12 mm	12,54	1	K7806M-12
13 mm	12,54	1	K7806M-13
14 mm	12,54	1	K7806M-14
15 mm	12,68	1	K7806M-15
16 mm	12,68	1	K7806M-16
17 mm	12,68	1	K7806M-17
18 mm	12,72	1	K7806M-18
19 mm	12,72	1	K7806M-19
21 mm	12,72	1	K7806M-21
22 mm	12,72	1	K7806M-22
23 mm	13,31	1	K7806M-23
24 mm	13,13	1	K7806M-24
27 mm	15,32	1	K7806M-27
30 mm	17,32	1	K7806M-30
32 mm	20,23	1	K7806M-32
36 mm	23,42	1	K7806M-36

SB = Em embalagem individual num cartão informativo de plástico



chave de caixas de impacto profundo de 1/2" com perfil métrico hexagonal e acabamento fosfatado - Embalagem para venda a retalho



SBK7806M

Ø	€	SB	SBK7806M-10
10 mm	13,15	1	SBK7806M-10
11 mm	13,15	1	SBK7806M-11
12 mm	13,15	1	SBK7806M-12
13 mm	13,15	1	SBK7806M-13
14 mm	13,15	1	SBK7806M-14
15 mm	13,30	1	SBK7806M-15
16 mm	13,30	1	SBK7806M-16
17 mm	13,30	1	SBK7806M-17
18 mm	13,34	1	SBK7806M-18
19 mm	13,34	1	SBK7806M-19
21 mm	13,34	1	SBK7806M-21
22 mm	13,34	1	SBK7806M-22
23 mm	13,93	1	SBK7806M-23
24 mm	13,75	1	SBK7806M-24
27 mm	15,93	1	SBK7806M-27
30 mm	17,94	1	SBK7806M-30
32 mm	20,85	1	SBK7806M-32
36 mm	24,04	1	SBK7806M-36

Chave de caixa, indicada. Para porcas de automóvel



K7801VM

Ø	€	SB	K7801VM-17
17 mm	12,96	1	K7801VM-17
19 mm	12,96	1	K7801VM-19
22 mm	13,82	1	K7801VM-22
24 mm	14,17	1	K7801VM-24

Para porcas de automóvel

Chave de impacto 1/2", 6 faces



K7801Z

Ø	€	SB	K7801Z-3/8
3/8 in	10,36	1	K7801Z-3/8
7/16 in	10,36	1	K7801Z-7/16
1/2 in	10,36	1	K7801Z-1/2
9/16 in	10,73	1	K7801Z-9/16
5/8 in	10,73	1	K7801Z-5/8
11/16 in	10,73	1	K7801Z-11/16
3/4 in	10,74	1	K7801Z-3/4
13/16 in	10,89	1	K7801Z-13/16
7/8 in	10,89	1	K7801Z-7/8
15/16 in	12,78	1	K7801Z-15/16
1 in	13,35	1	K7801Z-1
1 1/16 in	14,45	1	K7801Z-1.1/16
1 1/8 in	15,37	1	K7801Z-1.1/8
1 1/4 in	25,73	1	K7801Z-1.1/4
1 5/16 in	29,88	5	K7801Z-1.5/16
1 3/8 in	29,88	5	K7801Z-1.3/8
1 7/16 in	29,88	5	K7801Z-1.7/16
1 1/2 in	34,36	5	K7801Z-1.1/2

Chaves de Impacto 1/2" com perfil hexagonal imperial e acabamento em fosfato - Embalagem para venda a retalho



SBK7801Z

Ø	€	SB	SBK7801Z-3/8
3/8 in	11,00	1	SBK7801Z-3/8
7/16 in	11,00	1	SBK7801Z-7/16
1/2 in	11,00	1	SBK7801Z-1/2
9/16 in	11,36	1	SBK7801Z-9/16
5/8 in	11,36	1	SBK7801Z-5/8
11/16 in	11,36	1	SBK7801Z-11/16
3/4 in	11,36	1	SBK7801Z-3/4
13/16 in	11,52	1	SBK7801Z-13/16
7/8 in	11,52	1	SBK7801Z-7/8
15/16 in	13,40	1	SBK7801Z-15/16
1 in	13,93	1	SBK7801Z-1
1 1/16 in	15,02	1	SBK7801Z-1.1/16
1 1/8 in	15,92	1	SBK7801Z-1.1/8
1 1/4 in	26,17	1	SBK7801Z-1.1/4
1 5/16 in	30,28	1	SBK7801Z-1.5/16
1 3/8 in	30,28	1	SBK7801Z-1.3/8

Ø	€	SB	SBK7801Z-1.7/16
1 7/16 in	30,28	1	SBK7801Z-1.7/16
1 1/2 in	34,69	1	SBK7801Z-1.1/2

Chave Impacto Longa 1/2" Polegadas



K7806Z

Ø	€	SB	K7806Z-3/8
3/8 in	13,78	10	K7806Z-3/8
7/16 in	13,78	5	K7806Z-7/16
1/2 in	13,78	10	K7806Z-1/2
9/16 in	13,78	10	K7806Z-9/16
5/8 in	13,94	5	K7806Z-5/8
11/16 in	13,94	5	K7806Z-11/16
3/4 in	13,98	5	K7806Z-3/4
13/16 in	13,98	5	K7806Z-13/16
7/8 in	13,98	5	K7806Z-7/8
15/16 in	14,43	5	K7806Z-15/16
1 in	15,77	5	K7806Z-1
1 1/16 in	16,84	5	K7806Z-1.1/16
1 1/8 in	19,06	5	K7806Z-1.1/8
1 1/4 in	29,48	5	K7806Z-1.1/4
1 5/16 in	34,24	5	K7806Z-1.5/16
1 3/8 in	34,24	5	K7806Z-1.3/8
1 7/16 in	34,24	5	K7806Z-1.7/16
1 1/2 in	39,35	5	K7806Z-1.1/2

SB = Em embalagem individual num cartão informativo de plástico

Chaves de impacto profundas de 1/2" com perfil hexagonal imperial e acabamento fosfatado - Embalagem para venda a retalho



SBK7806Z

Ø	€	SB	SBK7806Z-3/8
3/8 in	14,40	10	SBK7806Z-3/8
7/16 in	14,40	10	SBK7806Z-7/16
1/2 in	14,40	10	SBK7806Z-1/2
9/16 in	14,40	10	SBK7806Z-9/16
5/8 in	14,55	5	SBK7806Z-5/8
11/16 in	14,55	1	SBK7806Z-11/16
3/4 in	14,60	1	SBK7806Z-3/4
13/16 in	14,60	1	SBK7806Z-13/16
7/8 in	14,60	1	SBK7806Z-7/8

Ø	€		
15/16 in	15,05	1	SBK7806Z-15/16
1 in	16,39	1	SBK7806Z-1
1 1/16 in	17,46	1	SBK7806Z-1.1/16
1 1/8 in	19,67	5	SBK7806Z-1.1/8
1 1/4 in	30,10	1	SBK7806Z-1.1/4
1 5/16 in	34,86	1	SBK7806Z-1.5/16
1 3/8 in	34,86	5	SBK7806Z-1.3/8
1 7/16 in	34,86	5	SBK7806Z-1.7/16
1 1/2 in	39,96	1	SBK7806Z-1.1/2

Chave de impacto TORX®



K7801TORX-E

Ø	€		
E10	13,63	1	K7801TORX-E10
E12	13,63	1	K7801TORX-E12
E14	13,63	1	K7801TORX-E14
E16	13,63	1	K7801TORX-E16
E18	13,63	1	K7801TORX-E18
E20	14,77	1	K7801TORX-E20
E24	14,77	1	K7801TORX-E24

Cardan



K8167S

Ø	Ø	€	
1/2"	1/2"	34,64	1 K8167S

Chave impacto 1/2" Hexagonal



7993S

Ø	€		
5 mm	44,05	1	7993S0050
6 mm	40,23	1	7993S0060
8 mm	40,23	1	7993S0080
10 mm	42,69	1	7993S0100
12 mm	42,69	1	7993S0120
14 mm	44,05	1	7993S0140
17 mm	44,05	1	7993S0170
18 mm	44,05	1	7993S0180
19 mm	44,05	1	7993S0190

Adaptador para bit 15/16"



7807H-7809H

Ø	Ø	€	
1/2"	1/4 in	34,05	1 7807H
1/2"	5/16 in	34,05	1 7808H
1/2"	11.2 mm	32,27	1 7809H
1/2"	1/4 in	47,20	1 SB7807H
1/2"	5/16 in	47,20	1 SB7808H
1/2"	7/16 in	52,27	1 SB7809H

Adaptador extensor de 1/2" a 3/4"



K7764D/SBK7764D

Ø	Ø	€	
M 3/8"	F 1/2"	24,02	1 K7764D
M 3/8"	F 1/2"	22,93	1 SBK7764D

SB = Em embalagem individual

Chave Impacto 1/2" Torx



7994S

Ø	€		
T20	21,12	1	7994S0200
T25	21,78	1	7994S0250
T27	22,45	1	7994S0270
T-30	23,07	1	7994S0300
T-40	23,07	1	7994S0400
T-45	23,07	1	7994S0450
T-50	23,07	1	7994S0500
T-55	24,40	1	7994S0550
T-60	26,99	1	7994S0600
T-70	27,00	1	7994S0700

Extensão



K8160D

Ø	€		
75 mm	14,10	1	K8160D-1
125 mm	17,36	1	K8160D-2
250 mm	27,51	1	K8160D-3
75 mm	14,85	1	SBK8160D-1
125 mm	18,10	1	SBK8160D-2
250 mm	28,26	1	SBK8160D-3

Adaptador de acionamento quadrado de 1/2" para 3/4" crescente com acabamento em fosfato



K8964D/SBK8964D

Ø	Ø	€	
3/4"	1/2"	16,59	1 K8964D
M 3/4"	F 1/2"	11,76	1 SBK8964D

SB = Em embalagem individual num cartão informativo de plástico



Freio de segurança



K560F-4/5

1/2"	10-14 mm	€	5	K560F-4
1/2"	15-32 mm	3,46	5	K560F-5

Conjunto de chaves de caixa de impacto ultracurtas quadradas, 1/2" - 13 peças



K7800M/13

43 x 128 x 195 mm	€	1	K7800M/13
	81,34		

K7800M-10, K7800M-11, K7800M-12, K7800M-13, K7800M-14, K7800M-15, K7800M-16, K7800M-17, K7800M-18, K7800M-19, K7800M-21, K7800M-22, K7800M-24

4750IB-A5

Jogo de chaves de caixa série longa, 6 faces



K7806M/S4

4	€	1	K7806M/S4
	51,24		

K7806M-19, K7806M-22, K7806M-17, K7806M-24

4750IB-A5

Jogo de chaves de caixa, indicadas. Para porcas de automóvel



K7801VM/S4

4	€	1	K7801VM/S4
	61,36		

Para porcas de automóvel

K7801VM-22, K7801VM-19, K7801VM-17, K7801VM-24

Conjunto de chaves impacto de 1/2", polegadas



K7801Z/10

10	60 x 220 x 280 mm	€	1	K7801Z/10
		113,44		

K7801Z-7/16, K7801Z-1/2, K7801Z-11/16, K7801Z-5/8, K7801Z-13/16, K7801Z-3/4, K7801Z-15/16, K7801Z-7/8, K7801Z-1, K7801Z-9/16

Conjunto de chaves impacto longas de 1/2", polegadas



K7806Z/10

10	60 x 220 x 280 mm	€	1	K7806Z/10
		141,37		

K7806Z-7/16, K7806Z-1/2, K7806Z-9/16, K7806Z-3/4, K7806Z-13/16, K7806Z-11/16, K7806Z-1, K7806Z-7/8, K7806Z-15/16, K7806Z-5/8

Jogo de chaves bi-sextavadas profundo, métrico, 1/2". DD/S14: 10-27mm



DD/S14

14	€	4	DD/S14
	96,77		

DD/S14: 10-27mm

K7806M-10, K7806M-11, K7806M-12, K7806M-13, K7806M-14, K7806M-15, K7806M-16, K7806M-17, K7806M-18, K7806M-19, K7806M-21, K7806M-22, K7806M-24, K7806M-27

Jogo com 20 chaves de caixa. 10, 11, 12, 13, 14, 15, 16, 17, 18, 19



D-DD/

20	€	4	D-DD/S20
	94,75		

10, 11, 12, 13, 14, 15, 16, 17, 18, 19

K7801M-10, K7801M-11, K7801M-12, K7801M-13, K7801M-14, K7801M-15, K7801M-16, K7801M-17, K7801M-18, K7801M-19

K7806M-10, K7806M-11, K7806M-12, K7806M-13, K7806M-14, K7806M-16, K7806M-17, K7806M-18, K7806M-19

Chave de caixa em milímetros. D/S10:
10-19mm



D/

D/	€	SB	Icon
10	61,26	6	D/S10

D/S10: 10-19mm

K7801M-10, K7801M-11, K7801M-12,
K7801M-13, K7801M-14, K7801M-15,
K7801M-16, K7801M-17, K7801M-18,
K7801M-19

Jogo de chaves bi-sextavadas, métrico,
1/2"



D/S14

D/S14	€	SB	Icon
14	83,71	6	D/S14

K7801M-10, K7801M-11, K7801M-12,
K7801M-13, K7801M-14, K7801M-15,
K7801M-16, K7801M-17, K7801M-18,
K7801M-19, K7801M-21, K7801M-22,
K7801M-24, K7801M-27

Jogo chaves de impacto longas em mm.
DD/S10: 10-19 mm, DD/S14: 10-27 mm



DD/

DD/	€	SB	Icon
10	60,33	6	DD/S10

DD/S10: 10-19 mm, DD/S14: 10-27 mm

K7806M-10, K7806M-11, K7806M-12,
K7806M-13, K7806M-14, K7806M-15,
K7806M-16, K7806M-17, K7806M-18,
K7806M-19

Chave de impacto, 6 faces



K8901M

Ø	€	SB	Icon
17 mm	23,17	1	K8901M-17
18 mm	23,15	1	K8901M-18
19 mm	23,17	1	K8901M-19
21 mm	23,26	1	K8901M-21
22 mm	23,26	1	K8901M-22
23 mm	23,26	1	K8901M-23
24 mm	24,15	1	K8901M-24
27 mm	25,49	1	K8901M-27
28 mm	26,66	1	K8901M-28
29 mm	29,88	1	K8901M-29
30 mm	32,66	1	K8901M-30
32 mm	32,56	1	K8901M-32
33 mm	33,39	1	K8901M-33
34 mm	33,36	1	K8901M-34
36 mm	35,18	1	K8901M-36
38 mm	36,73	1	K8901M-38
41 mm	43,67	1	K8901M-41
46 mm	44,35	1	K8901M-46
50 mm	72,67	1	K8901M-50
55 mm	87,58	1	K8901M-55
60 mm	102,80	1	K8901M-60

SB = Em embalagem individual num cartão informativo de plástico

Chave de impacto, 6 faces - Conjunto de
venda a retalho



SBK8901M

Ø	€	SB	Icon
17 mm	17,61	1	SBK8901M-17
18 mm	17,61	1	SBK8901M-18
19 mm	17,33	1	SBK8901M-19
21 mm	17,33	1	SBK8901M-21
22 mm	17,33	1	SBK8901M-22
23 mm	17,61	1	SBK8901M-23
24 mm	17,33	1	SBK8901M-24
27 mm	17,33	1	SBK8901M-27
28 mm	17,71	1	SBK8901M-28
29 mm	17,98	1	SBK8901M-29
30 mm	18,35	1	SBK8901M-30
32 mm	19,00	1	SBK8901M-32
33 mm	19,98	1	SBK8901M-33
34 mm	20,17	1	SBK8901M-34
36 mm	21,19	1	SBK8901M-36
38 mm	21,97	1	SBK8901M-38
41 mm	24,62	1	SBK8901M-41
46 mm	28,42	1	SBK8901M-46
55 mm	39,73	1	SBK8901M-55
60 mm	44,96	1	SBK8901M-60
50 mm	33,09	1	SBK8901M-50

SB = Em embalagem individual num cartão informativo de plástico

Chave de impacto 3/4" série longa, 6 faces



K8906M

Ø	€	SB	Icon
17 mm	42,73	1	K8906M-17
19 mm	43,71	1	K8906M-19
21 mm	44,43	1	K8906M-21
22 mm	44,43	1	K8906M-22
24 mm	45,14	1	K8906M-24
27 mm	46,84	1	K8906M-27
30 mm	47,83	1	K8906M-30
32 mm	50,94	1	K8906M-32
33 mm	51,67	1	K8906M-33
34 mm	54,42	1	K8906M-34
36 mm	56,30	1	K8906M-36
41 mm	58,73	1	K8906M-41
42 mm	62,69	1	K8906M-42
46 mm	67,58	1	K8906M-46

SB = Em embalagem individual num cartão informativo de plástico



Chave de impacto 3/4" em polegadas, 6 faces



K8901Z



Ø	€		
11/16 in	27,79	1	K8901Z-11/16
3/4 in	27,79	1	K8901Z-3/4
13/16 in	27,79	1	K8901Z-13/16
7/8 in	27,79	1	K8901Z-7/8
15/16 in	27,79	1	K8901Z-15/16
1 in	29,07	1	K8901Z-1
1 1/16 in	29,07	1	K8901Z-1.1/16
1 1/8 in	29,07	1	K8901Z-1.1/8
1 3/16 in	29,07	1	K8901Z-1.3/16
1 1/4 in	29,77	1	K8901Z-1.1/4
1 5/16 in	29,77	1	K8901Z-1.5/16
1 3/8 in	30,56	1	K8901Z-1.3/8
1 7/16 in	30,56	1	K8901Z-1.7/16
1 1/2 in	39,18	1	K8901Z-1.1/2
1 9/16 in	36,74	1	K8901Z-1.9/16
1 5/8 in	43,20	1	K8901Z-1.5/8
1 11/16 in	46,90	1	K8901Z-1.11/16
1 3/4 in	51,41	1	K8901Z-1.3/4
1 13/16 in	46,35	1	K8901Z-1.13/16
1 7/8 in	59,51	1	K8901Z-1.7/8
1 15/16 in	65,79	1	K8901Z-1.15/16
2 in	65,79	1	K8901Z-2
2 1/16 in	74,57	1	K8901Z-2.1/16
2 3/16 in	82,60	1	K8901Z-2.3/16
2 1/4 in	86,61	1	K8901Z-2.1/4
2 3/8 in	93,07	1	K8901Z-2.3/8

SB = Em embalagem individual num cartão informativo de plástico

Chave Impacto 3/4" Série Longa Polegadas



K8906Z



Ø	€		
3/4 in	46,69	1	K8906Z-3/4
13/16 in	46,69	1	K8906Z-13/16
7/8 in	46,69	1	K8906Z-7/8
15/16 in	46,69	1	K8906Z-15/16
1 mm	46,69	1	K8906Z-1
1 1/16 in	46,69	1	K8906Z-1.1/16
1.1/8 in	46,69	1	K8906Z-1.1/8

Ø	€		
1.1/4 in	48,55	1	K8906Z-1.1/4
1.5/16 in	55,47	1	K8906Z-1.5/16
1.3/8 in	56,00	1	K8906Z-1.3/8
1.7/16 in	56,00	1	K8906Z-1.7/16
1.1/2 in	57,73	1	K8906Z-1.1/2
1.5/8 in	57,73	1	K8906Z-1.5/8
1.3/4 in	69,94	1	K8906Z-1.3/4
2 mm	105,65	1	K8906Z-2

SB = Em embalagem individual num cartão informativo de plástico

Chave impacto 3/4" Hexagonal



7993T

Ø	€		
12 mm	53,60	1	7993T0120
14 mm	58,91	1	7993T0140
17 mm	58,91	1	7993T0170
19 mm	58,91	1	7993T0190
22 mm	70,48	1	7993T0220
24 mm	70,48	1	7993T0240

Adaptador para bits hexagonais macho de 22 mm



Cardan



K8967S

Ø	Ø	€		
3/4"	3/4"	92,02	1	K8967S

Adaptador extensor de 3/4" a 1"



K8164F

Ø	Ø	€		
1/2"	3/4"	33,68	1	K8164F

Adaptadores crescentes de 3/4" de encaixe quadrado para chave de caixas de 1" com acabamento em fosfato



K9564F

Ø	Ø	€		
1"	3/4"	37,34	1	K9564F

Extensão



K8960F

	€		
175 mm	45,94	1	K8960F-2
250 mm	55,15	1	K8960F-3
325 mm	59,76	1	K8960F-4

Freio de segurança



K560F-6

	€		
3/4"	3,93	5	K560F-6

Conjunto de chaves 3/4'



K8901M/8

	€		
8	238,09	1	K8901M/8

K8901M-27, K8901M-24, K8901M-21, K8901M-22, K8901M-30, K8901M-32, K8901M-36, K8901M-41

Conjunto de chaves longas 3/4', metrico



K8906M/8

	€		
8	370,28	1	K8906M/8

K8906M-24, K8906M-27, K8906M-30, K8906M-41, K8906M-36, K8906M-21, K8906M-22, K8906M-32

Conjunto de chaves 3/4', polegadas



K8901Z/8

	€		
8	247,09	1	K8901Z/8

K8901Z-1.1/16, K8901Z-1, K8901Z-1.3/8, K8901Z-1.5/16, K8901Z-1.1/4, K8901Z-1.1/2, K8901Z-1.7/16, K8901Z-1.1/8

Conjunto de chaves de caixa de impacto quadradas de 3/4" com perfil sextavado no sistema imperial e acabamento fosfatado - 18 peças



K8901Z/18

	€		
18	516,55	1	K8901Z/18

K8901Z-11/16, K8901Z-3/4, K8901Z-13/16, K8901Z-7/8, K8901Z-15/16, K8901Z-1, K8901Z-1.1/16, K8901Z-1.1/8, K8901Z-1.3/16, K8901Z-1.1/4, K8901Z-1.5/16, K8901Z-1.3/8, K8901Z-1.7/16, K8901Z-1.1/2, K8901Z-1.9/16, K8901Z-1.5/8, K8901Z-1.11/16, K8901Z-1.3/4

Conjunto de chaves longas 3/4', polegadas



K8906Z/8

	€		
8	413,80	1	K8906Z/8

K8906Z-1, K8906Z-1.1/16, K8906Z-1.1/8, K8906Z-1.1/4, K8906Z-1.5/16, K8906Z-1.3/8, K8906Z-1.7/16, K8906Z-1.1/2



Chave de impacto, 6 faces



K9501M

Ø	€		
22 mm	43,37	1	K9501M-22
24 mm	43,37	1	K9501M-24
27 mm	44,73	1	K9501M-27
30 mm	45,96	1	K9501M-30
32 mm	48,26	1	K9501M-32
33 mm	49,64	1	K9501M-33
34 mm	51,18	1	K9501M-34
36 mm	51,18	1	K9501M-36
38 mm	51,58	1	K9501M-38
41 mm	58,12	1	K9501M-41
42 mm	68,47	1	K9501M-42
46 mm	71,48	1	K9501M-46
50 mm	79,66	1	K9501M-50
55 mm	91,20	1	K9501M-55
60 mm	111,09	1	K9501M-60
65 mm	132,93	1	K9501M-65
70 mm	151,57	1	K9501M-70
75 mm	158,49	1	K9501M-75
80 mm	166,83	1	K9501M-80
85 mm	261,98	1	K9501M-85

Chave de impacto 1", 6 faces polegadas



K9501Z

Ø	€		
1 in	43,82	1	K9501Z-1
1 1/16 in	43,82	1	K9501Z-1.1/16
1 1/8 in	43,82	1	K9501Z-1.1/8
1 3/16 in	43,82	1	K9501Z-1.3/16
1 1/4 in	43,82	1	K9501Z-1.1/4
1 5/16 in	48,74	1	K9501Z-1.5/16
1 3/8 in	54,56	1	K9501Z-1.3/8
1 7/16 in	54,56	1	K9501Z-1.7/16
1 1/2 in	55,91	1	K9501Z-1.1/2
1 9/16 in	55,91	1	K9501Z-1.9/16
1 5/8 in	59,82	1	K9501Z-1.5/8
1 11/16 in	68,79	1	K9501Z-1.11/16
1 3/4 in	68,79	1	K9501Z-1.3/4
1 13/16 in	74,85	1	K9501Z-1.13/16
1 7/8 in	74,85	1	K9501Z-1.7/8
15/16 in	77,53	1	K9501Z-1.15/16
2 in	87,70	1	K9501Z-2
2 1/8 in	98,54	1	K9501Z-2.1/8
2 3/16 in	98,54	1	K9501Z-2.3/16
2 1/4 in	107,05	1	K9501Z-2.1/4
2 5/16 in	107,05	1	K9501Z-2.5/16
2 9/16 in	147,64	1	K9501Z-2.9/16
2 3/4 in	155,07	1	K9501Z-2.3/4

Adaptador para bits. com macho hexagonal de 22 mm



K9509H5

Ø	Ø	€	
22 mm	1"	97,16	1 K9509H5

com macho hexagonal de 22 mm

Chave de impacto série longa, 6 faces



K9506M

Ø	€		
22 mm	72,10	1	K9506M-22
24 mm	72,10	1	K9506M-24
27 mm	72,10	1	K9506M-27
30 mm	72,81	1	K9506M-30
32 mm	74,83	1	K9506M-32
33 mm	75,85	1	K9506M-33
34 mm	77,86	1	K9506M-34
36 mm	77,86	1	K9506M-36
38 mm	79,33	1	K9506M-38
41 mm	87,57	1	K9506M-41
46 mm	95,25	1	K9506M-46
50 mm	115,77	1	K9506M-50
55 mm	140,96	1	K9506M-55
60 mm	172,26	1	K9506M-60

Chave Impacto 1" longa Hexagonal



K9506Z

Ø	€		
1 in	64,50	1	K9506Z-1
1 1/16 in	65,52	1	K9506Z-1.1/16
1 3/16 in	65,52	1	K9506Z-1.3/16
1 1/4 in	65,73	1	K9506Z-1.1/4
1 7/16 in	65,73	1	K9506Z-1.7/16
1 1/2 in	67,93	1	K9506Z-1.1/2
1 5/8 in	73,42	1	K9506Z-1.5/8
1 13/16 in	94,12	1	K9506Z-1.13/16
1 7/8 in	106,15	1	K9506Z-1.7/8

Chave Impacto 1" Hexagonal



7993M

Ø	€		
17 mm	106,91	1	7993M0170
19 mm	106,91	1	7993M0190
22 mm	121,65	1	7993M0220
27 mm	123,41	1	7993M0270

Adaptador redutor de 1" a 3/4"



K8964G

Ø	Ø	€	
3/4"	1"	35,75	1 K8964G

Adaptador de acionamento quadrado de 1" para 1-1/2" com acabamento em fosfato



K9895G

1 1/2"	1"	€		
		175,52	1	K9895G

Extensão 1"



K9560G

	€		
100 mm	55,47	1	K9560G-0
125 mm	60,57	1	K9560G-1
175 mm	66,26	1	K9560G-2
325 mm	77,33	1	K9560G-3
300 mm	66,49	1	K9560G-4
400 mm	81,26	1	K9560G-5

Cardan



K9567S

1"	1"	€		
		193,31	1	K9567S

Bit com quadrado macho de 22 mm



K8909ML/K9509ML

	€		
12 mm	18,29	1	K8909ML-12
14 mm	18,29	1	K8909ML-14
17 mm	18,29	1	K8909ML-17
19 mm	18,77	1	K9509ML-19
22 mm	24,61	1	K9509ML-22
24 mm	24,68	1	K9509ML-24

Freio de segurança



K560F-7/8

	€		
1" 19-70 mm	4,44	5	K560F-7
1 & 1/2" 75-80 & 46-90 mm	5,82	5	K560F-8

Chave de impacto 1.1/2", 6 faces



K9801M

	€		
46 mm	202,35	1	K9801M-46
50 mm	202,35	1	K9801M-50
55 mm	214,30	1	K9801M-55
60 mm	237,97	1	K9801M-60

	€		
65 mm	258,86	1	K9801M-65
70 mm	279,56	1	K9801M-70
75 mm	303,32	1	K9801M-75
80 mm	332,98	1	K9801M-80
85 mm	382,60	1	K9801M-85
90 mm	424,22	1	K9801M-90
95 mm	501,30	1	K9801M-95
100 mm	538,35	1	K9801M-100
105 mm	582,87	1	K9801M-105
110 mm	736,18	1	K9801M-110
115 mm	776,42	1	K9801M-115
120 mm	835,88	1	K9801M-120
125 mm	862,83	1	K9801M-125
130 mm	958,70	1	K9801M-130
135 mm	1.054,56	1	K9801M-135
140 mm	1.102,50	1	K9801M-140
145 mm	1.214,35	1	K9801M-145
150 mm	1.438,07	1	K9801M-150
155 mm	1.629,79	1	K9801M-155

Chave impacto Hexagonal 1.1/2" série longa mm. Fabricada por pedido



K9806M

	€		
41 mm	413,41	1	K9806M-41
46 mm	413,41	1	K9806M-46
50 mm	413,41	1	K9806M-50
55 mm	413,41	1	K9806M-55
60 mm	423,37	1	K9806M-60
65 mm	469,53	1	K9806M-65
70 mm	527,92	1	K9806M-70
75 mm	590,42	1	K9806M-75
80 mm	714,10	1	K9806M-80
85 mm	718,54	1	K9806M-85
90 mm	758,76	1	K9806M-90
95 mm	893,22	1	K9806M-95
100 mm	973,39	1	K9806M-100
105 mm	1.069,91	1	K9806M-105
110 mm	1.366,00	1	K9806M-110
115 mm	1.521,45	1	K9806M-115
120 mm	2.921,82	1	K9806M-120

Fabricada por pedido



Chave Impacto Hexagonal 1.1/2" em Polegadas.. Fabricado por pedido



K9801Z

€	Icones	€	Icones
1 3/8 in	128,77	1	K9801Z-1.3/8
1 7/16 in	128,37	1	K9801Z-1.7/16
1 1/2 in	128,37	1	K9801Z-1.1/2
1 9/16 in	132,47	1	K9801Z-1.9/16
1 5/8 in	131,16	1	K9801Z-1.5/8
1 11/16 in	131,16	1	K9801Z-1.11/16
1 3/4 in	138,13	1	K9801Z-1.3/4
1 13/16 in	138,13	1	K9801Z-1.13/16
1 7/8 in	138,13	1	K9801Z-1.7/8
1 15/16 in	138,13	1	K9801Z-1.15/16
2 in	138,13	1	K9801Z-2
2 1/16 in	139,48	1	K9801Z-2.1/16
2 1/8 in	141,17	1	K9801Z-2.1/8
2 3/16 in	143,52	1	K9801Z-2.3/16
2 1/4 in	159,38	1	K9801Z-2.1/4
2 5/16 in	172,48	1	K9801Z-2.5/16
2 3/8 in	189,35	1	K9801Z-2.3/8
2 7/16 in	191,23	1	K9801Z-2.7/16
2 1/2 in	190,50	1	K9801Z-2.1/2
2 9/16 in	199,22	1	K9801Z-2.9/16
2 5/8 in	206,31	1	K9801Z-2.5/8
2 11/16 in	220,06	1	K9801Z-2.11/16
2 3/4 in	240,84	1	K9801Z-2.3/4
2 13/16 in	207,44	1	K9801Z-2.13/16
2 7/8 in	262,74	1	K9801Z-2.7/8
2 15/16 in	280,05	1	K9801Z-2.15/16
3 in	294,34	1	K9801Z-3
3 1/16 in	320,74	1	K9801Z-3.1/16
3 1/8 in	336,92	1	K9801Z-3.1/8
3 1/4 in	333,84	1	K9801Z-3.1/4
3 5/16 in	343,27	1	K9801Z-3.5/16
3 3/8 in	356,48	1	K9801Z-3.3/8
3 7/16 in	367,93	1	K9801Z-3.7/16
3 1/2 in	371,58	1	K9801Z-3.1/2
3 9/16 in	416,92	1	K9801Z-3.9/16
3 5/8 in	487,78	1	K9801Z-3.5/8
3 11/16 in	571,16	1	K9801Z-3.11/16
3 3/4 in	558,46	1	K9801Z-3.3/4
3 13/16 in	555,51	1	K9801Z-3.13/16
3 7/8 in	655,38	1	K9801Z-3.7/8
3 15/16 in	656,12	1	K9801Z-3.15/16
4 in	664,99	1	K9801Z-4
4 1/16 in	672,76	1	K9801Z-4.1/16
4 1/8 in	698,42	1	K9801Z-4.1/8
4 1/4 in	714,11	1	K9801Z-4.1/4
4 5/16 in	760,26	1	K9801Z-4.5/16
4 3/8 in	805,87	1	K9801Z-4.3/8
4 7/16 in	824,49	1	K9801Z-4.7/16
4 1/2 in	843,93	1	K9801Z-4.1/2
4 5/8 in	863,30	1	K9801Z-4.5/8
4 3/4 in	1.034,29	1	K9801Z-4.3/4

Fabricado por pedido

Chave Impacto Hexagonal 1.1/2" Série Longa Polegadas. Fabricada por pedido



K9806Z

€	Icones	€	Icones
1 3/8 in	192,23	1	K9806Z-1.3/8
1 7/16 in	193,68	1	K9806Z-1.7/16
1 1/2 in	191,80	1	K9806Z-1.1/2
1 5/8 in	193,68	1	K9806Z-1.5/8
1 11/16 in	193,68	1	K9806Z-1.11/16
2 in	203,04	1	K9806Z-2
2 1/16 in	203,04	1	K9806Z-2.1/16
2 3/16 in	219,94	1	K9806Z-2.3/16
2 1/4 in	228,69	1	K9806Z-2.1/4
2 5/16 in	233,61	1	K9806Z-2.5/16
2 3/8 in	280,84	1	K9806Z-2.3/8
2 7/16 in	281,96	1	K9806Z-2.7/16
2 1/2 in	285,95	1	K9806Z-2.1/2
2 9/16 in	287,56	1	K9806Z-2.9/16
2 5/8 in	347,52	1	K9806Z-2.5/8
2 11/16 in	353,53	1	K9806Z-2.11/16
2 3/4 in	369,05	1	K9806Z-2.3/4
2 13/16 in	385,78	1	K9806Z-2.13/16
2 7/8 in	407,54	1	K9806Z-2.7/8
2 15/16 in	412,67	1	K9806Z-2.15/16
3 in	443,87	1	K9806Z-3
3 1/16 in	466,96	1	K9806Z-3.1/16
3 1/8 in	490,65	1	K9806Z-3.1/8
3 3/16 in	499,06	1	K9806Z-3.3/16
3 1/4 in	526,10	1	K9806Z-3.1/4
3 5/16 in	526,14	1	K9806Z-3.5/16
3 3/8 in	546,32	1	K9806Z-3.3/8
3 7/16 in	569,51	1	K9806Z-3.7/16
3 1/2 in	569,51	1	K9806Z-3.1/2
3 9/16 in	607,91	1	K9806Z-3.9/16
3 5/8 in	598,68	1	K9806Z-3.5/8
3 11/16 in	759,13	1	K9806Z-3.11/16
3 3/4 in	780,76	1	K9806Z-3.3/4
3 13/16 in	759,13	1	K9806Z-3.13/16
3 7/8 in	841,26	1	K9806Z-3.7/8
3 15/16 in	819,72	1	K9806Z-3.15/16
4 in	828,55	1	K9806Z-4
4 1/16 in	808,33	1	K9806Z-4.1/16
4 1/8 in	1.014,18	1	K9806Z-4.1/8
4 1/4 in	1.047,80	1	K9806Z-4.1/4
4 5/16 in	1.165,07	1	K9806Z-4.5/16
4 3/8 in	1.256,31	1	K9806Z-4.3/8
4 1/2 in	1.300,33	1	K9806Z-4.1/2
4 5/8 in	1.332,66	1	K9806Z-4.5/8
4 3/4 in	1.422,03	1	K9806Z-4.3/4

Fabricada por pedido

Cardan 1.1/2"



K9867S

€	Icones	€	Icones
1 1/2	1 1/2	654,43	1 K9867S

Extensão Impacto 1.1/2"



K9860H

€	Icones	€	Icones
255 mm	416,85	1	K9860H-1
380 mm	459,82	1	K9860H-2
510 mm	463,86	1	K9860H-3

Adaptador de 1.1/2" para 1" e 2.1/2"



K9598H

€	Icones	€	Icones
1	1 1/2	274,25	1 K9598H

Adaptadores crescentes de encaixe quadrado de 1,1/2" para 2,1/2" com acabamento em fosfato



K9998H

		€		
2 1/2	1 1/2	932,29	1	K9998H

Adaptador redutor de 2,1/2" de encaixe quadrado para 1,1/2" com acabamento em fosfato



K9899H

		€		
1 1/2	2 1/2	1.222,34	1	K9899H

Freio de segurança



K560F-9

		€		
1 1/2"	95-120 mm	6,88	5	K560F-9





BAHCO



Chaves de parafusos



CHAVES DE PARAFUSOS ERGO™ COM PEGA DE BORRACHA E IDENTIFICAÇÃO POR CORES

Conjunto de chaves de parafuso. TORX®



ergo



BE-9885



€



5

40,50

1

BE-9885

TORX®

BE-8910, BE-8930, BE-8915, BE-8920, BE-8925



Conjunto de chaves de parafuso. Fenda e PHILLIPS®



ergo



BE-9881



€

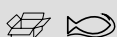

6

42,41

1

BE-9881

Fenda e PHILLIPS®

BE-8020, BE-8040



BE-8150, BE-8155



BE-8620, BE-8610



Conjunto de chaves de parafuso. Fenda e POZIDRIV®



ergo



BE-9882



€



6

44,13

1

BE-9882

Fenda e POZIDRIV®

BE-8020, BE-8040



BE-8155, BE-8150



BE-8810, BE-8820



Conjunto de 6 chaves ERGO™

Para parafusos de Fenda, Phillips e Pozidriv. Para parafusos retos, Phillips e Pozidriv



ergo



BE-9884



€



6

45,99

1

BE-9884

Para parafusos retos, Phillips e Pozidriv

BE-8611, BE-8621



BE-8040, BE-8241



BE-8811, BE-8821



Conjunto de chaves de parafuso. Fenda, PHILLIPS® e POZIDRIV®



ergo



BE-9886



€

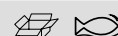

6

44,94

1

BE-9886

Fenda, PHILLIPS® e POZIDRIV®

BE-8030



BE-8150



BE-8621, BE-8611



BE-8821, BE-8811



BAHCO

Conjunto de 6 chaves ERGO™
Para parafusos de Fenda, Phillips, Pozidriv e TORX®. Para parafusos de fenda, Phillips, Pozidriv e TORX®



ergo



BE-9871

	€		
6	45,01	1	BE-9871

Para parafusos de fenda, Phillips, Pozidriv e TORX®

BE-8220S		
BE-8920, BE-8925		
BE-8820		
BE-8611, BE-8620		

Conjunto de chaves de parafusos de fenda/Phillips/Pozidriv/TORX® com pega de borracha - 8 peças



ergo



BE-9872

			€		
8	45 x 170 x 340 mm	595 g	74,76	1	BE-9872

BE-8925, BE-8920, BE-8915		
BE-8030		
BE-8821, BE-8811		
BE-8621, BE-8611		

Conjunto de chaves de parafusos ERGO™, 13 peças



ergo



BE-9875

	€		
13	100,25	1	BE-9875

BE-8040		
BE-8150, BE-8155		
BE-8621		
BE-8811, BE-8821		
BE-8910, BE-8915, BE-8920, BE-8925		
BE-8010S, BE-8230S		
BE-8811S		

Conjunto de chaves de parafusos de fenda/Phillips/Pozidriv/TORX® com pega de borracha - 13 peças



ergo



BE-9879

	€		
13	80,98	1	BE-9879

BE-8010, BE-8040		
BE-8150		
BE-8611, BE-8621		
BE-8811, BE-8821		
BE-8910, BE-8915, BE-8920, BE-8925		
BE-8220SL		
BE-8620SL		



Conjunto de chaves de parafusos ERGO™, 15 peças



ergo



BE-9877

	€		
15	108,65	1	BE-9877

BE-8030		
BE-8150		
BE-8611, BE-8621		
BE-8811, BE-8821		
BE-8910, BE-8915, BE-8920, BE-8925		
BE-8220S, BE-8040S, BE-8050S		
BE-8611S, BE-8621S		

Chaves de parafuso, fenda. Para parafusos de fenda



ergo



BE-8002 - BE-8252

			€		
2.0 mm	60 mm	17 mm	3,91	5	BE-8002
2.5 mm	60 mm	17 mm	4,04	5	BE-8010
2.5 mm	75 mm	17 mm	4,34	5	BE-8210
3.0 mm	60 mm	17 mm	5,74	5	BE-8020
3.0 mm	75 mm	17 mm	4,47	5	BE-8020L
3.0 mm	100 mm	17 mm	4,81	5	BE-8022
3.0 mm	125 mm	17 mm	6,52	5	BE-8220
3.0 mm	200 mm	17 mm	7,70	5	BE-8225
3.5 mm	75 mm	17 mm	4,94	5	BE-8030
3.5 mm	125 mm	17 mm	6,21	5	BE-8230
3.5 mm	200 mm	17 mm	7,93	5	BE-8235
4.0 mm	100 mm	20 mm	5,65	5	BE-8040
4.0 mm	175 mm	20 mm	9,28	5	BE-8240
5.5 mm	125 mm	27 mm	7,86	5	BE-8241
5.5 mm	150 mm	27 mm	8,79	5	BE-8242
5.5 mm	200 mm	27 mm	11,88	5	BE-8250L
6.0 mm	150 mm	36 mm	9,60	5	BE-8251
6.5 mm	150 mm	36 mm	10,37	5	BE-8252

Para parafusos de fenda

Chave de parafuso com cabeça fenda. Para parafusos de fenda



ergo



BE-8150 - BE-8258

			€		
5.5 mm	100 mm	27 mm	7,74	5	BE-8150
5.5 mm	150 mm	27 mm	10,63	5	BE-8250
6.5 mm	125 mm	36 mm	9,71	5	BE-8155
6.5 mm	150 mm	36 mm	11,03	5	BE-8255
8 mm	150 mm	36 mm	12,12	5	BE-8256
8 mm	175 mm	36 mm	12,45	5	BE-8257
10 mm	200 mm	36 mm	16,36	5	BE-8258

Para parafusos de fenda

Chaves de parafuso, fenda. Com colar hexagonal



ergo



BE-8158 - BE-8890

			€		
5.5 mm	125 mm	27 mm	12,54	5	BE-8158
6.5 mm	150 mm	36 mm	14,75	5	BE-8159
8 mm	125 mm	36 mm	14,39	5	BE-8160
8 mm	175 mm	36 mm	16,72	5	BE-8260
8 mm	175 mm	36 mm	17,09	5	BE-8865
10 mm	175 mm	36 mm	18,40	5	BE-8870
12 mm	200 mm	36 mm	23,49	5	BE-8880
14 mm	200 mm	36 mm	29,70	5	BE-8890

Com colar hexagonal

Chaves de parafuso, fenda. Tipo coto







ergo



BE-8330 - BE-8360

			€		
3.5 mm	25 mm	36 mm	5,29	5	BE-8330
4.0 mm	25 mm	36 mm	5,65	5	BE-8340
5.0 mm	25 mm	36 mm	7,25	5	BE-8350
5.0 mm	45 mm	36 mm	7,83	5	BE-8450

			€		
6.5 mm	25 mm	36 mm	7,58	5	BE-8355
6.0 mm	45 mm	36 mm	9,07	5	BE-8455
8.0 mm	25 mm	36 mm	8,70	5	BE-8360

Tipo coto

Chaves de parafuso, PHILLIPS®. Para parafusos Phillips







ergo



BE-8600 - BE-8624



			€		
PH 0	60 mm	17 mm	5,97	5	BE-8600
PH 0	100 mm	17 mm	6,13	5	BE-8605
PH 0	200 mm	17 mm	8,60	5	BE-8608
PH 1	75 mm	27 mm	7,33	5	BE-8610
PH 1	75 mm	20 mm	7,24	5	BE-8611
PH 1	* 200 mm	27 mm	10,97	5	BE-8610L
PH 2	100 mm	36 mm	8,19	5	BE-8620
PH 2	100 mm	27 mm	8,04	5	BE-8621
PH 2	150 mm	36 mm	9,14	5	BE-8622
PH 2	* 200 mm	36 mm	13,80	5	BE-8620L
PH 3	150 mm	36 mm	14,03	5	BE-8623
PH 4	200 mm	36 mm	19,43	5	BE-8624

Para parafusos Phillips

Chaves de parafuso, PHILLIPS®. Com colar hexagonal



ergo



BE-8628 - BE-8640



			€		
PH 1	100 mm	27 mm	9,73	5	BE-8628
PH 2	125 mm	36 mm	12,35	5	BE-8629
PH 3	150 mm	36 mm	16,91	5	BE-8630
PH 4	200 mm	36 mm	22,52	5	BE-8640

Com colar hexagonal

Chaves de parafuso, PHILLIPS®. Tipo coto



ergo



BE-8601/BE-8602



			€		
PH 1	25 mm	36 mm	7,84	5	BE-8601
PH 2	25 mm	36 mm	7,84	5	BE-8602

Tipo coto

Chaves de parafuso, POZIDRIV®. Para parafusos Pozidriv







ergo



BE-8800 - BE-8824



			€		
PZ 0	60 mm	17 mm	7,12	5	BE-8800
PZ 1	75 mm	27 mm	7,96	5	BE-8810
PZ 1	75 mm	20 mm	7,24	5	BE-8811
PZ 1	200 mm	27 mm	9,26	5	BE-8810L
PZ 2	100 mm	36 mm	9,71	5	BE-8820
PZ 2	100 mm	27 mm	16,37	5	BE-8821
PZ 2	200 mm	36 mm	19,76	5	BE-8820L
PZ 3	150 mm	36 mm	14,77	5	BE-8823
PZ 4	200 mm	36 mm	20,60	5	BE-8824

Para parafusos Pozidriv

Chaves de parafuso, POZIDRIV®. Com colar hexagonal







ergo



BE-8828 - BE-8840



			€		
PZ 1	100 mm	27 mm	11,93	5	BE-8828
PZ 2	125 mm	36 mm	15,34	5	BE-8829
PZ 3	150 mm	36 mm	14,81	5	BE-8830
PZ 4	200 mm	36 mm	19,38	5	BE-8840

Com colar hexagonal



Chaves de parafuso, POZIDRIV®. Tipo coto



ergo



BE-8801/BE-8802



			€		
PZ 1	25 mm	36 mm	8,03	5	BE-8801
PZ 2	25 mm	36 mm	8,03	5	BE-8802

Tipo coto

Chaves de parafuso, TORX®. Para parafusos TORX®



ergo



BE-8904 - BE-8945



			€		
T 4	75 mm	17 mm	7,51	5	BE-8904
T 5	75 mm	17 mm	7,51	5	BE-8905
T 6	75 mm	17 mm	7,58	5	BE-8906
T 7	75 mm	17 mm	7,63	5	BE-8907
T 8	75 mm	17 mm	7,66	5	BE-8908
T 9	75 mm	17 mm	7,69	5	BE-8909
T 10	75 mm	20 mm	7,70	5	BE-8910
T 15	100 mm	27 mm	7,86	5	BE-8915
T 20	100 mm	27 mm	7,96	5	BE-8920
T 25	125 mm	27 mm	8,49	5	BE-8925
T 27	125 mm	27 mm	8,71	5	BE-8927
T30	150 mm	36 mm	10,41	5	BE-8930
T40	150 mm	36 mm	12,55	5	BE-8940
T45	150 mm	36 mm	13,49	5	BE-8945

Para parafusos TORX®

Chaves de parafuso, TORX® Tamper Resistant. Para parafusos TORX® e TORX® Tamper Resistant



ergo



BE-7907 - BE-7940



			€		
TR 7	75 mm	17 mm	10,55	5	BE-7907
TR 8	75 mm	17 mm	10,59	5	BE-7908
TR 9	75 mm	17 mm	10,62	5	BE-7909

BAHCO

			€		
TR 10	75 mm	20 mm	10,66	5	BE-7910
TR 15	100 mm	27 mm	10,73	5	BE-7915
TR 20	100 mm	27 mm	10,79	5	BE-7920
TR 25	125 mm	27 mm	11,23	5	BE-7925
TR 27	125 mm	27 mm	11,40	5	BE-7927
TR 30	150 mm	36 mm	12,98	5	BE-7930
TR 40	150 mm	36 mm	15,17	5	BE-7940

Para parafusos TORX® e TORX® Tamper Resistant

Chaves ERGO™
Para parafusos TORX® com cabeça redonda. Para parafusos em esfera TORX®



ergo



BE-7515 - BE-7540



			€		
T 15	100 mm	27 mm	8,24	5	BE-7515
T 20	100 mm	27 mm	8,43	5	BE-7520
T 25	125 mm	27 mm	8,91	5	BE-7525
T 27	125 mm	27 mm	9,68	5	BE-7527
T 30	150 mm	36 mm	10,39	5	BE-7530
T 40	150 mm	36 mm	11,53	5	BE-7540

Para parafusos em esfera TORX®

Chaves ERGO™
Para parafusos TORX® Plus. Para parafusos TORX® Plus



ergo



BE-7715 - BE-7740



			€		
T 15	100 mm	27 mm	10,30	5	BE-7715
T 20	100 mm	27 mm	10,37	5	BE-7720
T 25	125 mm	27 mm	10,70	5	BE-7725
T 27	125 mm	27 mm	10,83	5	BE-7727
T 30	150 mm	36 mm	11,23	5	BE-7730
T 40	150 mm	36 mm	11,49	5	BE-7740

Para parafusos TORX® Plus

Chaves ERGO™
Para parafusos sextavados. Para parafusos sextavados



ergo



BE-6902 - BE-6903

Ø	L	l	€	Q	Q
2 mm	75 mm	17 mm	4,18	5	BE-6902
2.5 mm	75 mm	17 mm	4,25	5	BE-6925
3 mm	75 mm	20 mm	4,72	5	BE-6903

Para parafusos sextavados

Chaves Ballpoint para parafusos sextavados. Para parafusos sextavados



ergo



BE-8715 - BE-8710

Ø	L	l	€	Q	Q
1.5 mm	60 mm	17 mm	4,93	5	BE-8715
2 mm	100 mm	17 mm	5,11	5	BE-8702
2.5 mm	100 mm	17 mm	5,22	5	BE-8725
3 mm	100 mm	20 mm	5,29	5	BE-8703
4 mm	100 mm	27 mm	6,02	5	BE-8704
5 mm	100 mm	36 mm	7,47	5	BE-8705
6 mm	125 mm	36 mm	8,58	5	BE-8706
8 mm	150 mm	36 mm	12,28	5	BE-8708
10 mm	150 mm	36 mm	13,86	5	BE-8710

Para parafusos sextavados

Chaves ERGO™
Para parafusos de caixa sextavados em polegadas. Para parafusos sextavados, em polegadas



ergo



BE-8700-7/64 - BE-8700-5/16

Ø	L	l	€	Q	Q
7/64 in	100 mm	20 mm	8,87	5	BE-8700-7/64
5/32 in	100 mm	27 mm	6,23	5	BE-8700-5/32
3/16 in	100 mm	27 mm	7,98	5	BE-8700-3/16
7/32 in	100 mm	36 mm	8,58	5	BE-8700-7/32
1/4 in	125 mm	36 mm	10,06	5	BE-8700-1/4
5/16 in	150 mm	36 mm	14,20	5	BE-8700-5/16
3/8 in	150 mm	36 mm	18,16	5	BE-8700-3/8

Para parafusos sextavados, em polegadas

Chaves de parafuso, Robertson. Para parafusos Robertson (quadrados)



ergo



BE-9001 - BE-9003

Ø	L	l	€	Q	Q
# 1	80 mm	27 mm	8,82	5	BE-9001
# 2	80 mm	27 mm	9,48	5	BE-9002
# 3	100 mm	27 mm	9,87	5	BE-9003

Para parafusos Robertson (quadrados)

Chaves ERGO™
Para parafusos TRI-WING®. Para parafusos TRI-WING®



ergo



BE-9100 - BE-9105

Ø	L	l	€	Q	Q
0	80 mm	20 mm	9,35	5	BE-9100
1	80 mm	20 mm	9,35	5	BE-9101
2	80 mm	27 mm	9,35	5	BE-9102
3	80 mm	27 mm	9,35	5	BE-9103
4	100 mm	27 mm	10,73	5	BE-9104
5	100 mm	27 mm	10,73	5	BE-9105

Para parafusos TRI-WING®

Chave de parafusos Torq-set®. Para parafusos TORQ-SET®



ergo



BE-8080

Ø	L	l	€	Q	Q
1	75 mm	27 mm	15,20	5	BE-8080-1
2	75 mm	27 mm	15,66	5	BE-8080-2
3	75 mm	27 mm	15,66	5	BE-8080-3
4	75 mm	27 mm	15,66	5	BE-8080-4
5	75 mm	27 mm	15,66	5	BE-8080-5
6	75 mm	27 mm	15,66	5	BE-8080-6
8	100 mm	27 mm	21,63	5	BE-8080-8
10	100 mm	27 mm	21,63	5	BE-8080-10

Para parafusos TORQ-SET®



Furador, ponta quadrada



ergo®



BE-8985

			€		
6 mm	100 mm	27 mm	8,43	5	BE-8985

ERGO™ AWL. Tipo coto. Para primeiros cortes e furos



ergo®



BE-8986

			€		
4 mm	36 mm	50 mm	8,77	5	BE-8986

Tipo coto. Para primeiros cortes e furos

Furador



ergo®



BE-8980

			€		
6 mm	100 mm	27 mm	8,87	5	BE-8980

Chave tubular com cabo para electrónica



ergo®



BE-6400M

			€		
4 mm	75 mm	20 mm	12,21	5	BE-6400M-4
5 mm	75 mm	20 mm	12,89	5	BE-6400M-5
5.5 mm	75 mm	20 mm	12,89	5	BE-6400M-5.5
7 mm	75 mm	20 mm	14,15	5	BE-6400M-7

Chave de parafusos ponta longa, porta pontas



ergo®



BE-78

			€		
3 mm	125 mm	20 mm	12,21	5	BE-7803
3.5 mm	125 mm	20 mm	12,21	5	BE-7835
4 mm	125 mm	20 mm	12,21	5	BE-7804
4.5 mm	125 mm	20 mm	12,21	5	BE-7845
5 mm	125 mm	20 mm	12,89	5	BE-7805
5.5 mm	125 mm	20 mm	12,89	5	BE-7855
6 mm	125 mm	20 mm	13,49	5	BE-7806
7 mm	125 mm	27 mm	14,15	5	BE-7807
8 mm	125 mm	27 mm	17,03	5	BE-7808
9 mm	125 mm	36 mm	17,36	5	BE-7809
10 mm	125 mm	36 mm	17,86	5	BE-7810
11 mm	125 mm	36 mm	18,37	5	BE-7811
12 mm	125 mm	36 mm	20,73	5	BE-7812
13 mm	125 mm	36 mm	21,41	5	BE-7813
14 mm	125 mm	36 mm	23,27	5	BE-7814

Chave de parafusos sextavados, lâmina flexível



ergo®



BE-76

Ø	Comprimento	Comprimento	€	Quantidade	Modelo
6 mm	150 mm	27 mm	20,02	5	BE-7606
7 mm	150 mm	27 mm	20,30	5	BE-7607
8 mm	150 mm	27 mm	21,67	5	BE-7608

Chave para bits fêmea sextavado interior 1/4"



ergo®



BE-8577

Ø	Comprimento	Comprimento	€	Quantidade	Modelo
1/4 in	118 mm	36 mm	15,34	5	BE-8577

Chaves ERGO™ para ser usado com as lâminas substituíveis/bits sextavadas fêmeas 1/4"



ergo®



BE-8575

Ø	Comprimento	€	Quantidade	Modelo
1/4 in	122 mm	19,92	1	BE-8575

Lâminas sextavadas 1/4" para parafusos de fenda, 100mm



8020-2P - 8252-2P

Ø	Comprimento	€	Quantidade	Modelo
3.0 mm	0.5 mm	8,78	1	8020-2P
3.5 mm	0.6 mm	8,78	1	8030-2P
4.0 mm	0.8 mm	8,78	1	8040-2P
5.5 mm	1.0 mm	8,87	1	8242-2P
6.5 mm	1.2 mm	8,87	1	8252-2P

Lâminas sextavadas 1/4" para parafusos Phillips, 100mm



8600-2P - 8630-2P

Ø	€	Quantidade	Modelo
0	8,72	1	8600-2P
1	8,72	1	8610-2P
2	8,78	1	8620-2P
3	8,78	1	8630-2P

Lâminas sextavadas 1/4" para parafusos Pozidriv, 100mm



8800-2P - 8830-2P

Ø	€	Quantidade	Modelo
0	8,72	1	8800-2P
1	8,72	1	8810-2P
2	8,78	1	8820-2P
3	8,78	1	8830-2P



Lâminas sextavadas para parafusos TORX®, 100mm



8910-2P - 8940-2P



	€		
10	8,72	1	8910-2P
15	8,72	1	8915-2P
20	8,78	1	8920-2P
25	8,78	1	8925-2P
27	8,78	1	8927-2P
30	8,87	1	8930-2P
40	8,87	1	8940-2P

Lâminas sextavadas 1/4" para parafusos sextavados de cabeça redonda, 100mm



8703-2P - 8706-2P



	€		
3 mm	8,99	1	8703-2P
4 mm	8,99	1	8704-2P
5 mm	8,99	1	8705-2P
6 mm	8,99	1	8706-2P

Lâminas sextavadas 1/4" para parafusos de fenda, 300mm



8040L-2P - 8252L-2P



	€		
0.8 mm	12,53	1	8040L-2P
1.0 mm	12,53	1	8242L-2P
1.2 mm	12,53	1	8252L-2P

Lâminas sextavadas 1/4" para parafusos Phillips, 300mm



8610L-2P - 8620L-2P



	€		
1	12,34	1	8610L-2P
2	12,34	1	8620L-2P

Lâminas sextavadas 1/4" para parafusos Pozidriv, 300mm



8810L-2P - 8820L-2P



	€		
1	12,34	1	8810L-2P
2	12,34	1	8820L-2P

Lâminas hexagonais 1/4" para TORX®, parafusos, 300mm



8915L-2P - 8930L-2P



	€		
T15	13,35	1	8915L-2P
T20	13,35	1	8920L-2P
T25	13,35	1	8925L-2P
T27	13,35	1	8927L-2P
T30	13,35	1	8930L-2P

Lâminas hexagonais 1/4" para Phillips, parafusos, 400mm



8620XL-1P - 8252XL-1P



	€		
2	11,22	1	8620XL-1P
3	11,22	1	8630XL-1P

Lâmina hexagonal 1/4" para parafusos Pozidriv, 400mm



8820XL-1P - 8830XL-1P



	€		
2	11,22	1	8820XL-1P
3	11,22	1	8830XL-1P

Lâmina hexagonal 1/4" para parafusos de fenda, 400mm



8252XL-1P - 8256XL-1P



	€		
1.2 mm	11,22	1	8252XL-1P
6.5 mm			

Chaves ERGO™ com kit de lâminas substituíveis, 6 peças
Para parafusos de Fenda, Phillips e Pozidriv. Para parafusos de fenda, Phillips e Pozidriv



BE-8571

			€		
7	X	85 x 85 x 210 mm	63,59	1	BE-8571

Para parafusos de fenda, Phillips e Pozidriv

BE-8575		
8242-2P, 8252-2P		
8610-2P, 8620-2P		
8810-2P, 8820-2P		

Chaves ERGO™ com kit de lâminas substituíveis, 8 peças
Para parafusos de Fenda, Phillips, Pozidriv e TORX®. Para parafusos de fenda, Phillips, Pozidriv e TORX®



BE-8572

			€		
9	X	85 x 80 x 210 mm	67,44	1	BE-8572

Para parafusos de fenda, Phillips, Pozidriv e TORX®

BE-8575		
8242-2P, 8252-2P		
8610-2P, 8620-2P		
8810-2P, 8820-2P		
8910-2P, 8915-2P		



Chaves ERGO™ com kit de lâminas substituíveis, 7 peças
Para parafusos TORX®. Para parafusos TORX®



ergo



BE-8573

		€		
8	85 x 85 x 210 mm	65,53	1	BE-8573

Para parafusos TORX®

BE-8575		
8910-2P, 8915-2P, 8920-2P, 8925-2P, 8927-2P, 8930-2P, 8940-2P		

Chave de parafusos ERGO™ com lâminas substituíveis, 7 pcs. Para parafusos de fenda, Phillips, Pozidriv e TORX®



ergo



BE-8574

		€		
8	85 x 85 x 210 mm	66,09	1	BE-8574

Para parafusos de fenda, Phillips, Pozidriv e TORX®

BE-8575		
8610-2P, 8620-2P		
8040-2P		
8820-2P		
8920-2P, 8925-2P, 8930-2P		

Chaves ERGO™ com lâminas substituíveis/kit de bits, 22 peças
Para parafusos de Fendas, Phillips, Pozidriv, TORX® e sextavados.
Para parafusos de fenda, Phillips, Pozidriv, TORX® e hexagonais



ergo



BE-8576

	€		
23	130,47	1	BE-8576

Para parafusos de fenda, Phillips, Pozidriv, TORX® e hexagonais

BE-8575		
8030-2P, 8040-2P, 8242-2P, 8252-2P		
8810-2P, 8820-2P, 8830-2P		
8610-2P, 8620-2P, 8630-2P		
8910-2P, 8915-2P, 8925-2P, 8930-2P, 8940-2P		
59S/H2, 59S/H3, 59S/H5, 59S/H4, 59S/H6		
59S/H8		

CHAVES DE PARAFUSOS ERGO™ COM PEGA DE IMPACTO

Jogo de chaves ERGO™ com lâmina direta. Para parafusos de fenda e Phillips, haste hexagonal



ergo



BE-9881TB

	€		
6	56,70	1	BE-9881TB

Para parafusos de fenda e Phillips, haste hexagonal

BE-8135TB, BE-8145TB, BE-8150TB, BE-8155TB		
BE-8610TB, BE-8620TB		

Jogo de chaves ERGO™ com lâmina direta. Para parafusos de fenda e Pozidriv, haste hexagonal



ergo



BE-9882TB



€



6 59,39 1 BE-9882TB

Para parafusos de fenda e Pozidriv, haste hexagonal

BE-8135TB, BE-8145TB, BE-8150TB, BE-8155TB



BE-8810TB, BE-8820TB



Jogo de chaves ERGO™ com lâmina direta. Para parafusos TORX®, haste hexagonal



ergo



BE-9885TB



€



5 52,23 1 BE-9885TB

Para parafusos TORX®, haste hexagonal

BE-8915TB, BE-8920TB, BE-8925TB, BE-8930TB, BE-8940TB



Lâmina direta ERGO™. Para parafusos de fenda, haste hexagonal



ergo



BE-8135TB - BE-8262TB



€



Tip Size	Length	Hex Size	Price	Quantity	Model
3.5 mm	75 mm	27 mm	8,52	10	BE-8135TB
4.5 mm	100 mm	27 mm	11,22	10	BE-8145TB
5.5 mm	100 mm	27 mm	12,98	10	BE-8150TB
6.5 mm	125 mm	36 mm	15,25	5	BE-8155TB

Tip Size	Length	Hex Size	Price	Quantity	Model
8 mm	150 mm	36 mm	20,19	10	BE-8256TB
10 mm	175 mm	36 mm	24,34	10	BE-8258TB
12 mm	200 mm	36 mm	29,23	10	BE-8262TB
3.5 mm	75 mm	27 mm	9,15	1	SBE-8135TB
4.5 mm	100 mm	27 mm	11,83	1	SBE-8145TB
5.5 mm	100 mm	27 mm	13,59	1	SBE-8150TB
6.5 mm	125 mm	36 mm	15,88	1	SBE-8155TB

Para parafusos de fenda, haste hexagonal

Lâmina direta ERGO™. Para parafusos Phillips, haste hexagonal



ergo



BE-8610TB - BE-8624TB

Tip Size	Length	Hex Size	Price	Quantity	Model
PH 1	100 mm	27 mm	13,83	10	BE-8610TB
PH 2	125 mm	36 mm	15,35	10	BE-8620TB
PH 3	150 mm	36 mm	20,46	10	BE-8623TB
PH 4	175 mm	36 mm	29,78	10	BE-8624TB
PH 1	100 mm	27 mm	14,45	1	SBE-8610TB
PH 2	125 mm	36 mm	15,97	1	SBE-8620TB

Para parafusos Phillips, haste hexagonal

Lâmina direta ERGO™. Para parafusos Pozidriv, haste hexagonal



ergo



BE-8810TB - BE-8824TB

Tip Size	Length	Hex Size	Price	Quantity	Model
PZ 1	100 mm	27 mm	12,40	10	BE-8810TB
PZ 2	125 mm	36 mm	17,56	10	BE-8820TB
PZ 3	150 mm	36 mm	22,99	10	BE-8823TB
PZ 4	175 mm	36 mm	32,05	10	BE-8824TB
PZ 1	100 mm	27 mm	13,02	1	SBE-8810TB
PZ 2	125 mm	36 mm	18,17	1	SBE-8820TB

Para parafusos Pozidriv, haste hexagonal



Lâmina direta ERGO™. Para parafusos sextavados, haste hexagonal



ergo



BE-8910TB - BE-8940TB

			€		
T 10	75 mm	27 mm	8,03	5	BE-8910TB
T 15	100 mm	27 mm	10,89	5	BE-8915TB
T 20	100 mm	27 mm	11,08	5	BE-8920TB
T 25	100 mm	27 mm	11,78	5	BE-8925TB
T 27	125 mm	27 mm	12,88	5	BE-8927TB
T 30	150 mm	36 mm	13,53	5	BE-8930TB
T 40	150 mm	36 mm	15,28	5	BE-8940TB
T 15	100 mm	27 mm	11,50	1	SBE-8915TB
T 20	100 mm	27 mm	11,69	1	SBE-8920TB
T 25	100 mm	27 mm	12,39	1	SBE-8925TB
T 30	150 mm	36 mm	14,14	1	SBE-8930TB
T 40	150 mm	36 mm	15,89	1	SBE-8940TB

Para parafusos sextavados, haste hexagonal

CHAVES DE PARAFUSOS BAHCOFIT COM PEGA DE BORRACHA TEXTURADA

Jogo de chave de parafusos BahcoFit, 2 peças. Para parafusos Fenda e Phillips



B219.002

	€		
2	10,05	1	B219.002

B191.040.100

B192.001.100

Conjunto de chaves de parafusos BahcoFit, 2 peças



B219.012

	€		
2	12,67	1	B219.012

BAHCO

B190.055.125

B192.002.125



Jogo de chave de parafusos BahcoFit, 4 peças. Para parafusos Fenda e Phillips



B219.004

	€		
4	23,31	1	B219.004

B191.030.100, B191.055.125

B192.001.100, B192.002.125

Conjunto de chaves de fendas BahcoFit Phillips com Borracha - 4 unid.



B219.014

	€		
4	20,60	1	B219.014

B192.000.075, B192.001.100, B192.002.125, B192.003.150



Jogo de chave de parafusos BahcoFit, 5 peças. Para parafusos Fenda e Phillips



B219.005



€



5

27,20

1 B219.005

B191.030.075, B191.040.100

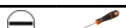

B190.055.125

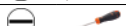

B192.001.100, B192.002.125



Jogo de chave de parafusos BahcoFit, 5 peças. Para parafusos de fenda e Pozidriv



B219.015



€



5

26,70

1 B219.015

B191.030.075, B191.040.100



B190.055.125



B193.001.100, B193.002.125



Jogo de chave de parafusos BahcoFit, 5 peças. Para parafusos TORX®



B219.025



€



5

30,40

1 B219.025

B194.010.075, B194.015.100, B194.020.100, B194.025.125, B194.030.150



Jogo de chave de parafusos BahcoFit, 5 peças. Para parafusos TORX® Tamper Resistant



B219.035



€



5

37,69

1 B219.035

B141.010.075, B141.015.100, B141.020.100, B141.025.125, B141.030.150



Conjunto de chaves de fendas BahcoFit com punho de borracha - 5 unid.



B219.045



€



5

23,69

1 B219.045

B191.030.100, B191.040.125



B190.055.125, B190.065.150, B190.080.175

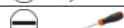

Jogo de chave de parafusos BahcoFit, 6 peças. Para parafusos Fenda e Phillips



B219.006



€

6 31,85 1 B219.006

B191.030.075, B191.040.100



B190.055.125, B190.065.125



B192.001.100, B192.002.125



Jogo de chave de parafusos BahcoFit, 6 peças. Para parafusos fenda e Pozidriv



B219.016



€

6 32,53 1 B219.016

B191.030.075, B191.040.100



B190.055.125, B190.065.125



B193.001.100, B193.002.125



Jogo de chave de parafusos BahcoFit, 6 peças. Para parafusos fenda, Phillips e Pozidriv



B219.026



€

6 33,73 1 B219.026

BAHCO

B191.030.075, B191.040.100



B192.001.100, B192.002.125



B193.001.100, B193.002.125



Jogo de chave de parafusos BahcoFit, 7 peças. Para parafusos Phillips e TORX®



B219.007



€

7 42,59 1 B219.007

B193.001.100, B193.002.125



B194.010.075, B194.015.100, B194.020.100, B194.025.125,



B194.030.150

Jogo de chave de parafusos BahcoFit, 7 peças. Para parafusos fenda e Phillips



B219.017



€

7 40,67 1 B219.017

B191.035.100, B191.040.100



B190.055.125, B190.065.150, B190.080.150

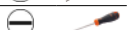

B192.001.100, B192.002.125



Conjunto de chaves de parafusos BahcoFit, 7 peças. Para parafusos TORX®



B219.027



	€		
7	44,03	1	B219.027

B194.010.075, B194.015.100, B194.020.100, B194.025.125,
B194.027.125, B194.030.150, B194.040.150



Jogo de chave de parafusos BahcoFit, 8 peças. Para parafusos Fenda e Phillips



B219.008



	€		
8	51,62	1	B219.008

B191.040.100, B191.055.125



B190.065.150, B190.080.175



B192.001.100, B192.002.125



B195.060.025



B195.002.025



Conjunto de chaves de parafusos de fenda/Phillips/Pozidriv/TORX® com pega de borracha - 10 peças



B219.110

	€		
10	61,55	1	B219.110

B190.055.100



B192.002.125



B193.002.125



B194.010.075, B194.015.100, B194.020.100



B196.025.075, B196.040.100



B142.001.080



806-1-1



Conjunto de chaves de parafusos TORX® BahcoFit com pega de borracha - 10 peças



B219.210



		€		
10	4.5 x 33 x 17 mm	60,24	1	B219.210

B194.006.075, B194.008.075, B194.009.075, B194.010.075,
B194.015.100, B194.020.100, B194.025.125, B194.027.125,
B194.030.150, B194.040.150



Jogo de chave de parafusos BahcoFit, 10 peças. Para parafusos Fenda, Phillips, Pozidriv e Robertson



B219.010

	€		
10	54,22	1	B219.010

B191.030.075		
B190.055.100, B190.065.125, B190.080.150		
B192.001.100, B192.002.125, B192.003.150		
B195.902.025		
B144.001.100, B144.002.125		

Chave de parafusos entalhados



B190

Ø	L	W	€		
4 mm	75 mm	24.5 mm	4,72	10	B190.040.075
4 mm	100 mm	24.5 mm	4,77	10	B190.040.100
5.5 mm	100 mm	30 mm	6,04	10	B190.055.100
5.5 mm	125 mm	30 mm	6,16	10	B190.055.125
6.5 mm	125 mm	34 mm	7,57	10	B190.065.125
6.5 mm	150 mm	34 mm	8,62	10	B190.065.150
8 mm	150 mm	34 mm	9,47	10	B190.080.150
8 mm	175 mm	34 mm	9,73	10	B190.080.175
10 mm	200 mm	34 mm	12,77	10	B190.100.200
12 mm	250 mm	34 mm	16,58	10	B190.120.250
14 mm	250 mm	34 mm	17,66	10	B190.140.250
4 mm	75 mm	24.5 mm	5,45	1	SB190.040.075
4 mm	100 mm	24.5 mm	5,51	1	SB190.040.100
5.5 mm	100 mm	30 mm	6,78	1	SB190.055.100
5.5 mm	125 mm	30 mm	6,91	1	SB190.055.125
6.5 mm	125 mm	34 mm	8,34	1	SB190.065.125
6.5 mm	150 mm	34 mm	9,37	1	SB190.065.150
8 mm	150 mm	34 mm	10,21	1	SB190.080.150
8 mm	175 mm	34 mm	10,47	1	SB190.080.175
10 mm	200 mm	34 mm	13,53	1	SB190.100.200
12 mm	250 mm	34 mm	17,34	1	SB190.120.250
14 mm	250 mm	34 mm	18,42	1	SB190.140.250

Chave de Parafusos Fenda



B191

Ø	L	W	€		
2.5 mm	75 mm	24.5 mm	3,40	10	B191.025.075
3 mm	75 mm	24.5 mm	3,50	10	B191.030.075
3 mm	100 mm	24.5 mm	3,75	10	B191.030.100
3 mm	200 mm	24.5 mm	6,02	10	B191.030.200
3.5 mm	100 mm	24.5 mm	3,86	10	B191.035.100
4 mm	100 mm	24.5 mm	4,42	10	B191.040.100
4 mm	125 mm	24.5 mm	4,85	10	B191.040.125
4 mm	250 mm	24.5 mm	7,25	10	B191.040.250
5.5 mm	125 mm	30 mm	6,14	10	B191.055.125
5.5 mm	150 mm	30 mm	6,87	10	B191.055.150
5.5 mm	300 mm	30 mm	9,27	10	B191.055.300
6.5 mm	150 mm	34 mm	8,10	10	B191.065.150
6.5 mm	300 mm	34 mm	10,63	10	B191.065.300
2.5 mm	75 mm	24.5 mm	4,13	1	SB191.025.075
3 mm	75 mm	24.5 mm	4,24	1	SB191.030.075
3 mm	100 mm	24.5 mm	4,50	1	SB191.030.100
3 mm	200 mm	24.5 mm	6,76	1	SB191.030.200
3.5 mm	100 mm	24.5 mm	4,63	1	SB191.035.100
4 mm	100 mm	24.5 mm	5,15	1	SB191.040.100
4 mm	125 mm	24.5 mm	5,60	1	SB191.040.125
4 mm	250 mm	24.5 mm	7,98	1	SB191.040.250
5.5 mm	125 mm	30 mm	6,90	1	SB191.055.125
5.5 mm	150 mm	30 mm	7,62	1	SB191.055.150
5.5 mm	300 mm	30 mm	10,02	1	SB191.055.300
6.5 mm	150 mm	34 mm	8,84	1	SB191.065.150
6.5 mm	300 mm	34 mm	11,38	1	SB191.065.300

Chave de parafusos tipo coto



B195

Ø	L	W	€		
4 mm	25 mm	33 mm	4,42	10	B195.040.025
5.0 mm	25 mm	33 mm	5,68	10	B195.050.025
6 mm	25 mm	33 mm	5,93	10	B195.060.025
4 mm	25 mm	33 mm	5,15	1	SB195.040.025
5 mm	25 mm	33 mm	6,41	1	SB195.050.025
6 mm	25 mm	33 mm	6,67	1	SB195.060.025

Chave de parafusos Phillips



B192



			€		
PH0	75 mm	24.5 mm	4,66	10	B192.000.075
PH0	200 mm	24.5 mm	6,71	10	B192.000.200
PH1	100 mm	30 mm	5,72	10	B192.001.100
PH1	250 mm	30 mm	8,56	10	B192.001.250
PH2	125 mm	34 mm	7,12	10	B192.002.125
PH2	150 mm	34 mm	7,51	10	B192.002.150
PH2	300 mm	34 mm	10,78	10	B192.002.300
PH3	150 mm	34 mm	10,96	10	B192.003.150
PH4	200 mm	34 mm	15,17	10	B192.004.200
PH0	75 mm	24.5 mm	5,41	1	SB192.000.075
PH0	200 mm	24.5 mm	7,47	1	SB192.000.200
PH1	100 mm	30 mm	6,47	1	SB192.001.100
PH1	250 mm	30 mm	9,31	1	SB192.001.250
PH2	125 mm	34 mm	7,87	1	SB192.002.125
PH2	300 mm	34 mm	11,52	1	SB192.002.300
PH3	150 mm	34 mm	11,70	1	SB192.003.150
PH4	200 mm	34 mm	15,92	1	SB192.004.200

Chave de parafusos tipo coto Phillips



B195PH



			€		
PH1	25 mm	33 mm	5,93	10	B195.001.025
PH2	25 mm	33 mm	5,93	10	B195.002.025
PH1	25 mm	33 mm	6,67	1	SB195.001.025
PH2	25 mm	33 mm	6,67	1	SB195.002.025

Chave de parafusos Pozidriv



B193



			€		
PZ0	75 mm	24.5 mm	5,54	10	B193.000.075
PZ1	100 mm	30 mm	6,21	10	B193.001.100
PZ2	125 mm	34 mm	7,57	10	B193.002.125
PZ3	150 mm	34 mm	11,54	10	B193.003.150
PZ4	200 mm	34 mm	16,08	10	B193.004.200
PZ0	75 mm	24.5 mm	6,30	1	SB193.000.075
PZ1	100 mm	30 mm	6,97	1	SB193.001.100
PZ2	125 mm	34 mm	8,34	1	SB193.002.125
PZ3	150 mm	34 mm	12,30	1	SB193.003.150
PZ4	200 mm	34 mm	16,83	1	SB193.004.200

Chave de parafusos tipo coto Pozidriv



B195PZ



			€		
PZ1	25 mm	33 mm	6,26	10	B195.901.025
PZ2	25 mm	33 mm	6,67	10	B195.902.025
PZ1	25 mm	33 mm	7,01	1	SB195.901.025
PZ2	25 mm	33 mm	7,43	1	SB195.902.025



Chave de parafusos TORX®



B194

				€		
T4		75 mm	24.5 mm	6,58	10	B194.004.075
T5		75 mm	24.5 mm	6,38	10	B194.005.075
T6		75 mm	24.5 mm	5,93	10	B194.006.075
T7		75 mm	24.5 mm	5,97	10	B194.007.075
T8		75 mm	24.5 mm	5,99	10	B194.008.075
T9		75 mm	24.5 mm	6,01	10	B194.009.075
T10		75 mm	24.5 mm	6,02	10	B194.010.075
T15		100 mm	24.5 mm	6,14	10	B194.015.100
T20		100 mm	24.5 mm	6,21	10	B194.020.100
T25		125 mm	30 mm	6,62	10	B194.025.125
T27		125 mm	30 mm	6,79	10	B194.027.125
T30		150 mm	34 mm	8,13	10	B194.030.150
T40		150 mm	34 mm	9,80	10	B194.040.150
T45		150 mm	34 mm	10,52	5	B194.045.150
T4		75 mm	24.5 mm	7,34	1	SB194.004.075
T5		75 mm	24.5 mm	7,16	1	SB194.005.075
T6		75 mm	24.5 mm	6,67	1	SB194.006.075
T7		75 mm	24.5 mm	6,70	1	SB194.007.075
T8		75 mm	24.5 mm	6,72	1	SB194.008.075
T9		75 mm	24.5 mm	6,75	1	SB194.009.075
T10		75 mm	24.5 mm	6,76	1	SB194.010.075
T15		100 mm	24.5 mm	6,90	1	SB194.015.100
T20		100 mm	24.5 mm	6,97	1	SB194.020.100
T25		125 mm	30 mm	7,38	1	SB194.025.125
T27		125 mm	30 mm	7,55	1	SB194.027.125
T30		150 mm	34 mm	8,88	1	SB194.030.150
T40		150 mm	34 mm	10,55	1	SB194.040.150
T45		150 mm	34 mm	11,27	1	SB194.045.150

Chave de parafusos TORX® Tamper Resistant



B141

				€		
TR7		75 mm	24.5 mm	8,24	5	B141.007.075
TR8		75 mm	24.5 mm	8,27	5	B141.008.075
TR9		75 mm	24.5 mm	8,31	5	B141.009.075
TR10		75 mm	24.5 mm	8,33	5	B141.010.075
TR15		100 mm	24.5 mm	8,40	5	B141.015.100
TR20		100 mm	24.5 mm	8,43	5	B141.020.100
TR25		125 mm	30 mm	8,77	5	B141.025.125
TR27		125 mm	30 mm	8,89	5	B141.027.125
TR30		150 mm	34 mm	10,14	5	B141.030.150
TR40		150 mm	34 mm	11,84	5	B141.040.150
TR7		75 mm	24.5 mm	8,99	1	SB141.007.075
TR8		75 mm	24.5 mm	9,02	1	SB141.008.075
TR9		75 mm	24.5 mm	9,04	1	SB141.009.075

BAHCO

				€		
TR10		75 mm	24.5 mm	9,07	1	SB141.010.075
TR15		100 mm	24.5 mm	9,13	1	SB141.015.100
TR20		100 mm	24.5 mm	9,17	1	SB141.020.100
TR25		125 mm	30 mm	9,53	1	SB141.025.125
TR27		125 mm	30 mm	9,66	1	SB141.027.125
TR30		150 mm	34 mm	10,90	1	SB141.030.150
TR40		150 mm	34 mm	12,60	1	SB141.040.150

Chave de parafusos hexagonal de esfera



B143

				€		
2		100 mm	24.5 mm	3,97	5	B143.020.100
2.5		100 mm	24.5 mm	4,07	10	B143.025.100
3		100 mm	24.5 mm	4,13	10	B143.030.100
4		100 mm	24.5 mm	4,80	10	B143.040.100
5		100 mm	30 mm	5,84	10	B143.050.100
6		125 mm	34 mm	6,70	10	B143.060.125
8		150 mm	34 mm	9,60	5	B143.080.150
2		100 mm	24.5 mm	4,75	1	SB143.020.100
2.5		100 mm	24.5 mm	4,83	1	SB143.025.100
3		100 mm	24.5 mm	4,88	1	SB143.030.100
4		100 mm	24.5 mm	5,44	1	SB143.040.100
5		100 mm	30 mm	6,58	1	SB143.050.100
6		125 mm	34 mm	7,46	1	SB143.060.125
8		150 mm	34 mm	10,34	1	SB143.080.150

Chave de parafusos (quadrados) Robertson



B144

				€		
#1		100 mm	24.5 mm	6,90	5	B144.001.100
#2		125 mm	30 mm	7,39	5	B144.002.125
#3		150 mm	34 mm	7,71	5	B144.003.150
#1		100 mm	24.5 mm	7,64	1	SB144.001.100
#2		125 mm	30 mm	8,15	1	SB144.002.125
#3		150 mm	34 mm	8,46	1	SB144.003.150

AWL



B145

Ø	Length	Tip Length	€	Icon	Icon	Code
6 mm	100 mm	30 mm	6,58	5	B145.006.100	
6 mm	100 mm	30 mm	7,34	1	SB145.006.100	

MANDRIL



B146

Ø	Length	Tip Length	€	Icon	Icon	Code
6 mm	100 mm	30 mm	6,92	5	B146.006.100	
6 mm	100 mm	30 mm	7,66	1	SB146.006.100	

Chave de parafusos tipo coto AWL. Para primeiros cortes e furos



B195Awl

Ø	Length	Tip Length	€	Icon	Icon	Code
4 mm	50 mm	33 mm	5,93	5	B195.006.050	
4 mm	50 mm	33 mm	6,67	1	SB195.006.050	

Chave de porca



B198

Ø	Length	Tip Length	€	Icon	Icon	Code
4 mm	125 mm	24.5 mm	9,56	5	B198.040.125	
4.5 mm	125 mm	24.5 mm	9,56	5	B198.045.125	
5 mm	150 mm	30 mm	10,06	5	B198.050.150	
5.5 mm	150 mm	30 mm	10,06	5	B198.055.150	
6 mm	150 mm	30 mm	10,52	5	B198.060.150	
6 mm	150 mm	34 mm	15,34	5	B198.060.150F	
7 mm	150 mm	34 mm	11,05	5	B198.070.150	
7 mm	150 mm	34 mm	15,86	5	B198.070.150F	
8 mm	150 mm	34 mm	13,30	5	B198.080.150	
8 mm	150 mm	34 mm	16,94	5	B198.080.150F	
9 mm	150 mm	34 mm	13,56	5	B198.090.150	
10 mm	150 mm	34 mm	13,95	5	B198.100.150	
11 mm	150 mm	34 mm	14,34	5	B198.110.150	
12 mm	150 mm	34 mm	16,19	5	B198.120.150	
13 mm	150 mm	34 mm	16,57	5	B198.130.150	
14 mm	150 mm	34 mm	18,16	5	B198.140.150	
4 mm	125 mm	24.5 mm	10,28	1	SB198.040.125	
4.5 mm	125 mm	24.5 mm	10,28	1	SB198.045.125	
5 mm	150 mm	30 mm	10,83	1	SB198.050.150	
5.5 mm	150 mm	30 mm	10,83	1	SB198.055.150	
6 mm	150 mm	30 mm	11,27	1	SB198.060.150	
6 mm	150 mm	34 mm	16,10	1	SB198.060.150F	
7 mm	150 mm	34 mm	11,80	1	SB198.070.150	
7 mm	150 mm	34 mm	16,59	1	SB198.070.150F	
8 mm	150 mm	34 mm	14,04	1	SB198.080.150	
8 mm	150 mm	34 mm	17,66	1	SB198.080.150F	
9 mm	150 mm	34 mm	14,31	1	SB198.090.150	
10 mm	150 mm	34 mm	14,71	1	SB198.100.150	
11 mm	150 mm	34 mm	15,10	1	SB198.110.150	
12 mm	150 mm	34 mm	16,96	1	SB198.120.150	
13 mm	150 mm	34 mm	17,46	1	SB198.130.150	
14 mm	150 mm	34 mm	18,91	1	SB198.140.150	



CHAVES DE PARAFUSOS COM PEGA EM BORRACHA

Jogo chaves parafusos 3 peças. Fenda e PH.



600-3



€



3

12,84

1 600-3

Fenda e PH.

613-3-100



611-5.5-125



615-1-100



Jogo de chaves de parafusos da série 600. De fenda 3, 5,5 e PH 1, PH 2



602-4-LA



€



4

18,10

1 602-4-LA

De fenda 3, 5,5 e PH 1, PH 2

613-3-100



611-5.5-100



615-1-100, 615-2-125



Jogo chaves Parafusos 5 peças. Fenda e PH



604-5



€



5

24,05

1 604-5

Fenda e PH

613-3-100



611-4-100, 611-6.5-125



615-1-100, 615-2-125



Jogo Chaves Parafusos 5 peças. Torx



612-5



€



5

28,87

1 612-5

=D1293

618-10-75, 618-15-100, 618-20-100, 618-25-125, 618-30-150



Jogo Chaves Parafusos 6 peças. Fenda, PH e PZ



605-6



	€		
6	29,23	1	605-6

Fenda, PH e PZ

613-3-75, 613-4-100		
615-1-100, 615-2-125		
616-1-100, 616-2-125		

Jogo Chaves parafusos 6 peças. Fenda e PH.



606-6



	€		
6	28,28	1	606-6

Fenda e PH.

611-5.5-100, 611-6.5-125		
613-3-75, 613-4-100		
615-1-100, 615-2-125		

Jogo chaves parafusos. Fenda e PZ



610-6



	€		
6	29,09	1	610-6

Fenda e PZ

611-5.5-100, 611-6.5-125		
613-3-75, 613-4-100		
616-1-100, 616-2-125		

Jogo de chaves de parafusos da série 600. De fenda, Phillips e Robertson



605-10-PC-AU



	€		
10	56,12	1	605-10-PC-AU

De fenda, Phillips e Robertson

611-5.5-100, 611-6.5-125, 611-8-150		
613-3-75		
615-1-100, 615-2-125, 615-3-150		
616-2-25, 619-1-100, 619-2-100		



Chaves de Parafusos Fenda. Série 600



611

Ø	Comprimento	Comprimento do Bico	€	Quantidade	Referência
3.5 mm	75 mm	25 mm	3,11	10	611-3.5-75
3.5 mm	100 mm	25 mm	3,26	10	611-3.5-100
4.0 mm	75 mm	25 mm	3,72	10	611-4-75
4.0 mm	100 mm	25 mm	4,15	10	611-4-100
5.5 mm	100 mm	30 mm	4,95	10	611-5.5-100
5.5 mm	125 mm	30 mm	5,22	10	611-5.5-125
6.5 mm	25 mm	35 mm	6,29	10	611-6.5-25
6.5 mm	125 mm	35 mm	6,31	10	611-6.5-125
6.5 mm	150 mm	35 mm	6,61	10	611-6.5-150
8.0 mm	150 mm	35 mm	8,02	10	611-8-150
8.0 mm	175 mm	35 mm	8,49	10	611-8-175
10.0 mm	200 mm	35 mm	10,25	10	611-10-200

Série 600

Chaves de Parafusos Fenda Recta



613

Ø	Comprimento	Comprimento do Bico	€	Quantidade	Referência
3.0 mm	75 mm	25 mm	3,10	10	613-3-75
3.0 mm	100 mm	25 mm	3,16	10	613-3-100
3.5 mm	100 mm	25 mm	3,27	10	613-3.5-100
4.0 mm	100 mm	25 mm	3,67	10	613-4-100
4.0 mm	125 mm	25 mm	4,05	10	613-4-125
5.5 mm	150 mm	30 mm	5,42	10	613-5.5-150
6.5 mm	150 mm	35 mm	6,86	10	613-6.5-150

Chaves Parafusos Phillips®



615

Ø	Comprimento	Comprimento do Bico	€	Quantidade	Referência
PH 0	75 mm	25 mm	3,40	10	615-0-75
PH 1	100 mm	30 mm	4,97	10	615-1-100
PH 2	25 mm	35 mm	6,29	10	615-2-25

BAHCO

Tip	Comprimento	Comprimento do Bico	€	Quantidade	Referência
PH 2	125 mm	35 mm	6,41	10	615-2-125
PH 3	150 mm	35 mm	9,74	10	615-3-150

Chaves Parafusos Pozidriv®. Série 600



616

Tip	Comprimento	Comprimento do Bico	€	Quantidade	Referência
PZ 0	75 mm	25 mm	4,42	10	616-0-75
PZ 1	100 mm	30 mm	5,35	10	616-1-100
PZ 2	125 mm	35 mm	6,88	10	616-2-125
PZ 3	150 mm	35 mm	10,32	10	616-3-150

Série 600

Chaves Parafusos Torx®. Série 600



618

Tip	Comprimento	Comprimento do Bico	€	Quantidade	Referência
T 10	75 mm	25 mm	5,15	10	618-10-75
T 15	100 mm	25 mm	5,42	10	618-15-100
T 20	100 mm	25 mm	5,42	10	618-20-100
T 25	125 mm	30 mm	6,29	10	618-25-125
T 27	125 mm	30 mm	6,29	10	618-27-125
T 30	150 mm	35 mm	7,74	10	618-30-150
T 40	150 mm	35 mm	8,79	10	618-40-150

Série 600

CHAVES PARA PARAFUSOS COM PUNHO DE ROQUETE

Chave porta bits roquete



808050

			€		
1/4"	125 mm	41.6 mm	41,83	50	808050

Conjunto de pontas 1/4" para trabalhos pesados, para chaves de porcas e pontas de fenda/Phillips/Pozidriv/TORX®/sextavadas com suporte para chave de roquete - 36 peças



59/S36BCR

		€		
36	43 x 135 x 215 mm	54,53	6	59/S36BCR

Chave roquete porta bits com luz LED.



808050L

			€		
1/4 in	10x35 mm	808050L	40,34	25	808050L
		808050L	10,25	1	808050L-SP1

Chave Porta bits Pistola



808050P

			€		
1/4 in	135 mm	40 mm	40,34	50	808050P

Jogo chave roquete pistola porta bits, 25 peças



808050P-

	€		
70 x 158 x 285 mm	127,62	10	808050P-25

Chave Roquete suporte bits cabo "T"



808050TS

			€		
1/4 in	68 mm	91 mm	21,43	1	808050TS



Chave Roquete Suporte bits curta



808050S

			€		
1/4 in	68 mm	41 mm	21,43	25	808050S

Jogo chave roquete curta suporte bits 18 peças



808050S-18

	€		
46 x 130 x 195 mm	37,78	30	808050S-18

Jogo chave roquete curta suporte bits 22 peças



808050S-22

	€		
46 x 130 x 195 mm	37,78	30	808050S-22

CHAVES DE PARAFUSOS DE PRECISÃO

Jogo Chaves parafuso Precisão 6 peças. Fenda e PH



706-1

	€		
6	45,66	1	706-1

Fenda e PH

- 700-2-50, 700-2.5-50, 700-1.5-50, 700-3-50
- 701-0-50, 701-1-75

Jogo Chaves parafuso Precisão 6 peças. Fenda e PH



706-2

	€		
6	47,60	1	706-2

Fenda e PH

- 700-1.5-50, 700-1.2-50, 700-1-50, 700-1.8-50
- 701-00-50, 701-0-50

Jogo Chaves Parafuso Precisão 6 peças. Fenda



706-3

	€		
--	---	--	--

6 47,60 1 706-3

Fenda

700-2.5-50, 700-2-50, 700-1.8-50, 700-1.5-50, 700-1.2-50, 700-1-50	
--	--

Jogo Chaves Parafuso Precisão 7 peças. Fenda, PH e Torx.



706-4

	€		
--	---	--	--

7 53,63 1 706-4

Fenda, PH e Torx.

700-2.5-50, 700-3.5-75, 700-1.5-50	
701-1-75, 701-0-50	
703-8-50, 703-6-50	

Jogo Chaves Parafuso Precisão 24 peças. Fenda, PH, PZ, Torx e Hexagonais



706-5

	€		
--	---	--	--

24 181,59 1 706-5

Fenda, PH, PZ, Torx e Hexagonais

700-3-50, 700-2-50, 700-3.5-75, 700-4-75, 700-1.5-50, 700-1.2-50, 700-1-50, 700-1.8-50	
701-00-50, 701-0-50, 701-1-75	
702-1-75, 702-0-50	
703-6-50, 703-9-50, 703-10-50, 703-7-50, 703-8-50, 703-15-75, 703-20-75	
704-2.5-50, 704-3-75, 704-1.5-50, 704-2-50	

Chaves de Parafusos de Precisão Fenda



700

			€		
1 mm	50 mm	14 mm	7,67	5	700-1-50
1.2 mm	50 mm	14 mm	7,67	5	700-1.2-50
1.5 mm	50 mm	14 mm	7,67	5	700-1.5-50
1.8 mm	50 mm	14 mm	7,67	5	700-1.8-50
2 mm	50 mm	14 mm	6,71	5	700-2-50
2.5 mm	50 mm	14 mm	6,71	5	700-2.5-50
3 mm	50 mm	14 mm	6,42	5	700-3-50
3 mm	100 mm	14 mm	6,42	5	700-3-100
3 mm	200 mm	14 mm	7,38	5	700-3-200
3.5 mm	75 mm	14 mm	6,71	5	700-3.5-75
4 mm	75 mm	14 mm	6,95	5	700-4-75
4 mm	250 mm	14 mm	8,66	5	700-4-250



Chaves Parafusos Precisão Phillips®



701



			€		
PH 00	50 mm	14 mm	7,96	5	701-00-50
PH 0	50 mm	14 mm	6,71	5	701-0-50
PH 0	200 mm	14 mm	8,44	5	701-0-200
PH 1	75 mm	14 mm	7,51	5	701-1-75
PH 1	250 mm	14 mm	7,97	5	701-1-250

Chaves de Parafusos de Precisão Pozidriv®



702



			€		
PZ 0	50 mm	14 mm	7,56	5	702-0-50
PZ 1	75 mm	14 mm	8,04	5	702-1-75

Chaves de Parafusos de Precisão Torx®



703



			€		
T 4	50 mm	14 mm	9,18	5	703-4-50
T 5	50 mm	14 mm	9,18	5	703-5-50
T 6	50 mm	14 mm	7,35	5	703-6-50
T 7	50 mm	14 mm	7,35	5	703-7-50
T 8	50 mm	14 mm	7,35	5	703-8-50
T 9	50 mm	14 mm	7,35	5	703-9-50
T 10	50 mm	14 mm	7,35	5	703-10-50
T 15	75 mm	14 mm	7,35	5	703-15-75
T 20	75 mm	14 mm	7,35	5	703-20-75

Chaves de Parafusos de Precisão Hexagonal



704



			€		
1.5	50 mm	14 mm	8,44	5	704-1.5-50
2	50 mm	14 mm	8,44	5	704-2-50
2.5	50 mm	14 mm	8,44	5	704-2.5-50
3	75 mm	14 mm	8,44	5	704-3-75
3/32	75 mm	14 mm	8,43	5	704Z-3/32

Chave de parafusos de precisão, 4 lâminas



510034



			€		
0.25x1.5, 0.3x2, 0.4x2.5, 0.5x3	8.5 mm		17,37	10	510034

Chaves de parafuso, fenda



2784



			€		
2.5 mm	6 mm	100 mm	35,78	1	2784-2.5
3.5 mm	6 mm	104 mm	35,78	1	2784-3.5
4.5 mm	10 mm	110 mm	35,78	1	2784-4.5

Conjunto de chaves de fenda de precisão



98505

	€		
5	33,26	5	98505

Conjunto de chaves de fenda de precisão



510031

	€		
6	37,03	5	510031

Conjunto de chaves de fenda de precisão



510033

	€		
3	24,41	5	510033

CHAVES DE PARAFUSOS COM PEGA EM T

Jogo Chaves Cabo T Hexagonal 6 peças



903T-1

	€		
6	76,66	1	903T-1

3-4-5-6-8-10 mm

900T-030-100, 900T-040-150, 900T-050-150, 900T-060-200, 900T-080-200, 900T-100-200

Jogo Chaves Cabo T Torx 6 peças



903T-2

	€		
6	70,74	1	903T-2

T-10, T-15, T-20, T-25, T-30, T-40

901T-015-150, 901T-020-150, 901T-010-100, 901T-030-200, 901T-040-200, 901T-025-150



Jogo Chaves Cabo T para porcas 6 peças



903T-3



€



6

87,63

1

903T-3

5-6-7-8-10-13 mm

902T-060-150, 902T-070-175, 902T-050-150, 902T-080-175, 902T-100-175, 902T-130-175

Chave Hexagonal Cabo T



900T



€



Bit Size	Length	Width	Price	Quantity	Code
2 mm	100 mm	50 mm	10,41	5	900T-020-100
2.5 mm	100 mm	50 mm	10,41	5	900T-025-100
3 mm	100 mm	50 mm	10,41	5	900T-030-100
4 mm	138 mm	50 mm	11,63	5	900T-040-150
5 mm	138 mm	60 mm	12,09	5	900T-050-150
6 mm	185 mm	60 mm	12,85	5	900T-060-200
8 mm	185 mm	60 mm	14,09	5	900T-080-200
10 mm	185 mm	60 mm	15,61	5	900T-100-200

Chave "T" Torx®



901T



€



Bit Size	Length	Width	Price	Quantity	Code
T 6	100 mm	50 mm	7,54	5	901T-006-100
T 7	100 mm	50 mm	7,54	5	901T-007-100
T 8	100 mm	50 mm	7,54	5	901T-008-100
T 9	100 mm	50 mm	7,54	5	901T-009-100
T 10	100 mm	50 mm	10,69	5	901T-010-100
T 15	138 mm	50 mm	10,88	5	901T-015-150
T 20	138 mm	50 mm	10,88	5	901T-020-150
T 25	138 mm	60 mm	11,93	5	901T-025-150
T 27	138 mm	60 mm	11,93	5	901T-027-150
T 30	185 mm	60 mm	12,85	5	901T-030-200

BAHCO

			€		
T 40	185 mm	60 mm	13,45	5	901T-040-200
T 45	185 mm	60 mm	13,45	5	901T-045-200
T 50	185 mm	60 mm	13,45	5	901T-050-200

Chave "T" Stecker



902T



€



Bit Size	Length	Width	Price	Quantity	Code
5 mm	136 mm	50 mm	12,49	5	902T-050-150
5.5 mm	136 mm	50 mm	12,49	5	902T-055-150
6 mm	136 mm	50 mm	13,32	5	902T-060-150
7 mm	160 mm	60 mm	14,09	5	902T-070-175
8 mm	160 mm	60 mm	14,36	5	902T-080-175
9 mm	160 mm	60 mm	14,36	5	902T-090-175
10 mm	160 mm	60 mm	15,30	5	902T-100-175
11 mm	160 mm	60 mm	15,30	5	902T-110-175
12 mm	160 mm	60 mm	17,14	5	902T-120-175
13 mm	160 mm	60 mm	18,06	5	902T-130-175

Chave "T" aperto chaves caixa 1/4"



905T



€



Bit Size	Length	Width	Price	Quantity	Code
1/4"	45 mm	60 mm	16,08	5	905T-060-100

CHAVES DE PARAFUSOS COM SUPORTES DE BITS DE 1/4"

Suporte magnético de bits



B705



€



Bit Size	Length	Width	Price	Quantity	Code
1/4" in	125 mm	30 mm	12,00	5	B705.1/4.125
1/4" in	125 mm	30 mm	12,73	1	SB705.1/4.125

Chave "T" suporte bits



904T



		€		
1/4 in	150 mm	19,21	5	904T-060-150

Chaves de parafuso, PHILLIPS®. Com colar hexagonal



9778

			€		
PH 1	80 mm	24 mm	7,85	10	9778-1
PH 2	110 mm	27 mm	10,73	10	9778-2
PH 3	150 mm	30 mm	14,48	5	9778-3

Com colar hexagonal

Chave para bits fêmea sextavado interior 1/4" Magnetizada. Fornecida com 5 bits TORX®



808050A/TORX



			€		
1/4 in	115 mm	40 mm	26,73	1	808050A
1/4 in	115 mm	40 mm	26,11	50	808050TORX

Fornecida com 5 bits TORX®

Chaves de parafuso, POZIDRIV®. Com colar hexagonal



9778PZD

			€		
PZ 1	80 mm	24 mm	8,19	10	9778PZD-1
PZ 2	110 mm	27 mm	11,16	10	9778PZD-2

Com colar hexagonal

CHAVES DE PARAFUSOS COM PEGA DE MADEIRA OU PLASTICO

Chaves de parafuso, fenda. Com colar hexagonal



9710



			€		
3.5 mm	75 mm	22 mm	5,45	10	9710-3.5-75
5.5 mm	100 mm	24 mm	7,24	10	9710-5.5-100
6.5 mm	125 mm	27 mm	8,36	10	9710-6.5-125
8.0 mm	150 mm	30 mm	9,64	5	9710-8-150
10.0 mm	175 mm	32 mm	11,55	5	9710-10-175

Com colar hexagonal

Conjunto de chaves de parafuso. Fenda e PHILLIPS®



9710/S6

	€		
6	52,16	1	9710/S6

Fenda e PHILLIPS®

9710-4.5-90

9710-5.5-100, 9710-6.5-125, 9710-8-150

9778-1, 9778-2



Chave Reversível Fenda 6 e PH-2. Fenda, PH



1019/1067



Bit Type	Length	Price (€)	Quantity	Part No.
PH 1	4,5 mm	3,49	10	1067
PH 2	6 mm	4,63	10	1019

Fenda, PH

Chave de parafusos reversível



8052



Bit Type	Length	Width	Price (€)	Quantity	Part No.
PH 2	80 mm	28 mm	28,73	5	8052

Chave de parafusos reversível, Tipo coto



1016



Bit Type	Length	Price (€)	Quantity	Part No.
PH 2	6 mm	4,69	10	1016

Jogo chave parafusos reversível, 6 lâminas.. 6 lâminas



6



Bit Type	Length	Price (€)	Quantity	Part No.
PH 0, PH 1, PH 2	3,5-5,0-6,5 mm	17,61	1	6

6 lâminas

Chave de parafuso com lâmina pasante. Para parafusos de fenda



9715



Bit Type	Length	Width	Price (€)	Quantity	Part No.
PH 2	250 mm	32 mm	44,67	5	9715-14-250

Para parafusos de fenda

Chaves de parafuso, fenda. Com cabo plástico cônico



7372I



Bit Type	Length	Width	Price (€)	Quantity	Part No.
PH 2	63 mm	13 mm	13,17	10	7372I-2-63
PH 2	75 mm	13 mm	13,17	10	7372I-2.5-75
PH 2	80 mm	13 mm	13,17	10	7372I-3-80

Com cabo plástico cônico

FERRAMENTAS DE TESTE ELÉTRICAS

Busca-pólos



806				€		
				4,56	6	806-1-1
3.0 mm	65 mm	16 mm				
				5,96	6	806-1-2
3.5 mm	100 mm	17.5 mm				

Voltímetros com pega de plástico transparente

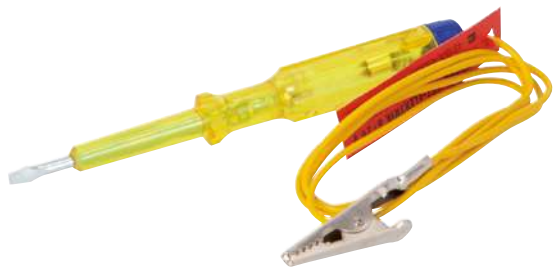

806-1-3				€		
				6,04	6	806-1-3
3 mm	45 mm	16 mm				

Busca-pólos



8045VDE				€		
				17,12	10	8045VDE
3.5 mm	77 mm	14 mm				

Busca-pólos



8045LVDE				€		
				20,96	10	8045LVDE
3.5 mm	42 mm	16 mm				

ACESSÓRIOS

Magnetizador / desmagnetizador



M780				€		
				20,42	1	M780
29 x 52 x 50 mm						

Magnetizador/Desmagnetizador



M781				€		
				12,91	5	M781
22 x 125 x 40 mm						





BAHCO



Chaves hexagonais Offset



PONTAS SEXTAVADAS

Chave Hexagonal offset, niquelada



1998M

Ø	L	€	Icon 1	Icon 2	Icon 3
1.5 mm	47 mm	0,60	10	1998M-1.5	
2 mm	52 mm	0,62	10	1998M-2	
2.5 mm	59 mm	0,66	10	1998M-2.5	
3.0 mm	66 mm	0,86	10	1998M-3	
4.0 mm	74 mm	0,77	10	1998M-4	
5.0 mm	85 mm	1,07	10	1998M-5	
6.0 mm	96 mm	1,31	10	1998M-6	
7.0 mm	102 mm	1,84	10	1998M-7	
8.0 mm	108 mm	2,11	10	1998M-8	
9.0 mm	114 mm	2,82	5	1998M-9	
10 mm	122 mm	2,94	10	1998M-10	
12.0 mm	137 mm	4,32	5	1998M-12	
14.0 mm	154 mm	5,84	1	1998M-14	
17.0 mm	177 mm	9,24	1	1998M-17	
19.0 mm	199 mm	13,86	1	1998M-19	
22.0 mm	222 mm	20,55	1	1998M-22	

Jogo Chaves Hexagonais offset, niquelado. 6 peças



1998M/

Ø	Icon X	€	Icon 1	Icon 2	Icon 3
2, 2.5, 3, 4, 5, 6 mm	6	7,29	1	1998M/6T	

1998M-4, 1998M-5, 1998M-6, 1998M-2.5, 1998M-2, 1998M-3

Jogo de chaves, métrico, niquelado



1998M/8T

Ø	Icon X	€	Icon 1	Icon 2	Icon 3
2, 2.5, 3, 4, 5, 6, 7, 8 mm	8	11,72	1	1998M/8T	

1998M-3, 1998M-2, 1998M-6, 1998M-7, 1998M-4, 1998M-5, 1998M-8, 1998M-2.5

Jogo de chaves, métrico, niquelado



1998M/10T

Ø	Icon X	€	Icon 1	Icon 2	Icon 3
2, 2.5, 3, 4, 5, 6, 7, 8, 9, 10 mm	10	17,89	1	1998M/10T	

1998M-5, 1998M-4, 1998M-7, 1998M-6, 1998M-2, 1998M-3, 1998M-2.5, 1998M-8, 1998M-9, 1998M-10

Jogo de chaves, métrico, niquelado. 11 peças



1998M/11T

Ø	Icon X	€	Icon 1	Icon 2	Icon 3
2, 2.5, 3, 4, 5, 6, 7, 8, 9, 10, 12 mm	11	23,18	1	1998M/11T	

1998M-5, 1998M-4, 1998M-7, 1998M-6, 1998M-2, 1998M-3, 1998M-2.5, 1998M-8, 1998M-9, 1998M-10, 1998M-12

Jogo de chaves, métrico, niquelado



1998M/15T

Ø	Icon X	€	Icon 1	Icon 2	Icon 3
2, 2.5, 3, 4, 5, 6, 7, 8, 9, 10, 12, 14, 17, 19, 22 mm	15	75,84	1	1998M/15T	

1998M-2, 1998M-5, 1998M-4, 1998M-7, 1998M-6, 1998M-3, 1998M-2.5, 1998M-14, 1998M-17, 1998M-19, 1998M-22, 1998M-8, 1998M-9, 1998M-10, 1998M-12

Jogo Chaves Hexagonais offset niquelado, 9 peças



BE-9878

Ø	Icon X	€	Icon 1	Icon 2	Icon 3
1.5, 2, 2.5, 3, 4, 5, 6, 8, 10 mm	9	14,44	1	BE-9878	

1998M-1.5, 1998M-2.5, 1998M-2, 1998M-3, 1998M-4, 1998M-5, 1998M-6, 1998M-8, 1998M-10

Jogo Chaves Hexagonais offset em anel.



1998M/8R

Ø	Icon X	€	Icon 1	Icon 2	Icon 3
2, 2.5, 3, 4, 5, 6, 7, 8 mm	8	12,72	1	1998M/8R	

Conjunto de chaves de parafuso offset hexagonais. Aço CROMO-VANADIUM



1999M/7H

Ø	Icon X	€	Icon 1	Icon 2	Icon 3
2.5 3 4 5 6 8 10 mm	7	32,77	1	1999M/7H	

Aço CROMO-VANADIUM 2.5, 3, 4, 5, 6, 8, 10

Para parafusos sextavados de caixa, 12 peças



BE-9880

		€		
--	--	---	--	--

0.050; 1/16; 5/64; 3/32;
7/64; 1/8; 9/64; 5/32;
3/16; 7/32; 1/4; 5/16 in

12 38,37 3 BE-9880

Chave parafusos offset Hexagonal.



1995M

		€		
--	--	---	--	--

0.9 mm	33 mm	0,80	10	1995M-0.9
1.5 mm	47 mm	0,50	10	1995M-1.5
2.0 mm	52 mm	0,55	10	1995M-2
2.5 mm	59 mm	0,57	10	1995M-2.5
3.0 mm	66 mm	0,76	10	1995M-3
4.0 mm	74 mm	0,86	10	1995M-4
5.0 mm	85 mm	0,82	10	1995M-5
6.0 mm	96 mm	1,03	10	1995M-6
7.0 mm	102 mm	1,47	10	1995M-7
8.0 mm	108 mm	1,84	10	1995M-8
9.0 mm	114 mm	2,12	10	1995M-9
10 mm	122 mm	2,37	10	1995M-10
12 mm	137 mm	3,83	10	1995M-12
14 mm	154 mm	5,40	10	1995M-14
17 mm	177 mm	8,66	10	1995M-17
19 mm	199 mm	13,05	10	1995M-19
22 mm	222 mm	19,45	10	1995M-22

Chave parafusos offset Hexagonal.
Polegadas, preto



1995Z

		€		
--	--	---	--	--

1/16 in	47 mm	0,54	10	1995Z-1/16
5/64 in	52 mm	0,44	10	1995Z-5/64
3/32 in	59 mm	0,47	10	1995Z-3/32

		€		
1/8 in	66 mm	0,60	10	1995Z-1/8
5/32 in	74 mm	0,74	10	1995Z-5/32
3/16 in	85 mm	0,84	10	1995Z-3/16
7/32 in	91 mm	0,97	10	1995Z-7/32
1/4 in	96 mm	1,19	10	1995Z-1/4
5/16 in	108 mm	2,00	10	1995Z-5/16
3/8 in	122 mm	2,89	10	1995Z-3/8
7/16 in	129 mm	4,43	10	1995Z-7/16
1/2 in	145 mm	5,42	10	1995Z-1/2
5/8 in	168 mm	9,79	10	1995Z-5/8
3/4 in	199 mm	16,52	10	1995Z-3/4

Polegadas, preto

Jogo Chaves de parafuso offset
Hexagonais. Acabamento preto



1995M/

		€		
--	--	---	--	--

2, 2.5, 3, 4, 5, 6 mm	6	5,59	1	1995M/6T
-----------------------	---	------	---	----------

Acabamento preto

1995M-2, 1995M-2.5, 1995M-6, 1995M-5, 1995M-4, 1995M-3

Jogo de chaves hexagonais Offset,
métrico, em preto



1995M/8T

		€		
--	--	---	--	--

2, 2.5, 3, 4, 5, 6, 7, 8 mm	8	10,34	1	1995M/8T
-----------------------------	---	-------	---	----------

1995M-2.5, 1995M-2, 1995M-6, 1995M-5, 1995M-4, 1995M-3, 1995M-7, 1995M-8

Jogo de chaves hexagonais Offset,
métrico, em preto



1995M/10T

		€		
--	--	---	--	--

2, 2.5, 3, 4, 5, 6, 7, 8, 9, 10 mm	10	16,71	1	1995M/10T
------------------------------------	----	-------	---	-----------

1995M-2.5, 1995M-2, 1995M-6, 1995M-5, 1995M-4, 1995M-3, 1995M-9, 1995M-10, 1995M-7, 1995M-8

Jogo de chaves hexagonais Offset,
métrico, em preto. 11 peças



1995M/11T

		€		
--	--	---	--	--

2, 2.5, 3, 4, 5, 6, 7, 8, 9, 10, 12 mm	11	20,55	1	1995M/11T
--	----	-------	---	-----------

1995M-2, 1995M-6, 1995M-5, 1995M-4, 1995M-2.5, 1995M-3, 1995M-9, 1995M-10, 1995M-7, 1995M-8, 1995M-12

Jogo de chaves hexagonais Offset,
métrico, em preto



1995M/15T

		€		
--	--	---	--	--

2, 2.5, 3, 4, 5, 6, 7, 8, 9, 10, 12, 14, 17, 19, 22 mm	15	70,42	1	1995M/15T
--	----	-------	---	-----------

1995M-2.5, 1995M-2, 1995M-6, 1995M-5, 1995M-4, 1995M-3, 1995M-9, 1995M-10, 1995M-7, 1995M-8, 1995M-17, 1995M-19, 1995M-12, 1995M-14, 1995M-22



Jogo Chaves de parafuso offset Hexagonais 9 peças. Acabamento Preto



BE-9578

		€		
1.5, 2, 2.5, 3, 4, 5, 6, 8, 10 mm	9	13,04	1	BE-9578

Acabamento Preto

1995M-2,5, 1995M-2, 1995M-1.5, 1995M-6, 1995M-5, 1995M-4, 1995M-3, 1995M-8, 1995M-10

Conjunto chave de parafusos offset hexagonal 7 peças



BE-9777B

		€		
2.5 3 4 5 6 8 10 mm	7	23,49	6	BE-9777B

2.5, 3, 4, 5, 6, 8, 10 mm

Conjunto de chaves de parafusooffset hexagonais. Aço CROMO-VANADIUM



BE-9776

	€		
1.5 2 2.5 3 4 5 6 mm	18,06	6	BE-9776

Aço CROMO-VANADIUM 1.5, 2, 2.5, 3, 4, 5, 6 mm

Jogo de chaves de parafusos sextavados



BE-9777

		€		
2.5 3 4 5 6 8 10 mm	7	24,49	6	BE-9777

Chaves parafusos offset hexagonal, polegadas, preto



1995Z/

		€		
1/16, 5/64, 3/32, 1/8, 5/32, 3/16, 7/32, 1/4, 5/16, 3/8 in	10	13,79	1	1995Z/10T

1995Z-1/16, 1995Z-5/64, 1995Z-3/32, 1995Z-1/8, 1995Z-5/32, 1995Z-3/16, 1995Z-3/8, 1995Z-7/32, 1995Z-1/4, 1995Z-5/16

Jogo de chaves hexagonais Offset, em polegadas, em preto



1995Z/12T

		€		
1/16, 5/64, 3/32, 1/8, 5/32, 3/16, 7/32, 1/4, 5/16, 3/8, 7/16, 1/2 in	12	22,45	1	1995Z/12T

1995Z-1/16, 1995Z-5/64, 1995Z-3/32, 1995Z-1/8, 1995Z-5/32, 1995Z-3/16, 1995Z-1/2, 1995Z-7/16, 1995Z-3/8, 1995Z-7/32, 1995Z-1/4, 1995Z-5/16

Conjunto de chaves de parafuso offset hexagonais. Aço CROMO-VANADIUM



BE-9787

		€		
3/32 1/8 5/32 3/16 1/4 5/16 3/8 in	7	25,91	6	BE-9787

Aço CROMO-VANADIUM

Chave parafusos offset Hexagonal. Milímetros, Preto



1995LM

		€		
1.5 mm	91 mm	0,70	10	1995LM-1.5
2 mm	102 mm	0,51	10	1995LM-2
2.5 mm	114 mm	0,61	10	1995LM-2,5
3.0 mm	129 mm	0,80	10	1995LM-3
4.0 mm	144 mm	0,92	10	1995LM-4
5.0 mm	165 mm	1,35	10	1995LM-5
6.0 mm	186 mm	2,02	10	1995LM-6
7.0 mm	197 mm	2,66	10	1995LM-7
8.0 mm	208 mm	3,46	10	1995LM-8
9.0 mm	219 mm	4,32	10	1995LM-9
10 mm	234 mm	4,86	10	1995LM-10
12 mm	262 mm	7,29	10	1995LM-12
14 mm	294 mm	9,00	10	1995LM-14

Milímetros, Preto

Jogo Chaves de parafuso offset Hexagonais 6 peças. Acabamento Preto



BE-9586

		€		
1.5, 2, 2.5, 3, 4, 5 mm	6	10,06	1	BE-9586

Acabamento Preto

1995LM-1.5, 1995LM-3, 1995LM-2,5, 1995LM-2, 1995LM-4, 1995LM-5

Jogo de chaves hexagonais Offset de série longa, 9 pcs



BE-9588

		€		
1.5, 2, 2.5, 3, 4, 5, 6, 8, 10 mm	9	20,67	1	BE-9588

1995LM-1.5, 1995LM-2, 1995LM-2.5, 1995LM-3, 1995LM-4, 1995LM-5, 1995LM-6, 1995LM-8, 1995LM-10

Chaves de Parafusos Offset Hexagonal. Ponta Bola, Preta



1996M

		€		
1.5 mm	91 mm	1,62	10	1996M-1.5
2.0 mm	102 mm	1,80	10	1996M-2
2.5 mm	114 mm	1,63	10	1996M-2.5
3.0 mm	129 mm	1,68	10	1996M-3
4.0 mm	144 mm	2,00	10	1996M-4
5.0 mm	165 mm	3,27	10	1996M-5
6.0 mm	186 mm	3,72	10	1996M-6
8.0 mm	208 mm	5,24	10	1996M-8
10 mm	234 mm	9,39	10	1996M-10
12 mm	262 mm	10,04	5	1996M-12

Ponta Bola, Preta

Conjunto Hex L-Key de Bola Longa Metrica Colorida - 9 Pcs



C1997LM/9P

		€		
1.5, 2, 2.5, 3, 4, 5, 6, 8, 10 mm	9	36,77	1	C1997LM/9P

1996M-1.5, 1996M-2, 1996M-2.5, 1996M-3, 1996M-4, 1996M-5, 1996M-6, 1996M-8, 1996M-10

Conjunto de chaves de parafuso offset hexagonais. Aço CROMO-VANADIUM



BE-9765

		€		
1.5, 2, 2.5, 3, 4, 5 mm	6	10,75	3	BE-9765

Aço CROMO-VANADIUM

1996M-1.5, 1996M-2.5, 1996M-2, 1996M-4, 1996M-3, 1996M-5

Jogo de chaves hexagonais Offset de série longa, em esfera, métrico, em preto



BE-9770

		€		
1.5, 2, 2.5, 3, 4, 5, 6, 8, 10 mm	9	17,72	3	BE-9770

1996M-1.5, 1996M-2.5, 1996M-2, 1996M-4, 1996M-3, 1996M-5, 1996M-6, 1996M-10, 1996M-8

Jogo Chaves de parafuso offset Hexagonais. Acabamento Preto



BE-9676

		€		
1.5, 2, 2.5, 3, 4, 5 mm	6	17,43	1	BE-9676

Acabamento Preto

1996M-5, 1996M-4, 1996M-3, 1996M-2.5, 1996M-2, 1996M-1.5

Jogo de chaves hexagonais Offset, em esfera, métrico, em preto, 9 pcs



BE-9678

		€		
1.5, 2, 2.5, 3, 4, 5, 6, 8, 10 mm	9	32,28	1	BE-9678

1996M-4, 1996M-5, 1996M-2.5, 1996M-3, 1996M-10, 1996M-6, 1996M-8, 1996M-2, 1996M-1.5

Jogo Chaves de parafuso offset Hexagonais Magnetizado. Acabamento Preto



BE-9688

		€		
1.5, 2, 2.5, 3, 4, 5, 6, 8, 10 mm	9	34,47	1	BE-9688

Acabamento Preto

1996M-1.5, 1996M-2, 1996M-2.5, 1996M-3, 1996M-4, 1996M-5, 1996M-6, 1996M-8, 1996M-10

Chave de parafusos offset com ponta em bola hexagonal, 7peças. 2.5,3,4,5,6,8,10



BE-9776B

		€		
2.5, 3, 4, 5, 6, 8, 10 mm	7	34,92	6	BE-9776B

2,5,3,4,5,6,8,10



Conjunto de chaves de parafuso offset hexagonais. Aço CROMO-VANADIUM



BE-9775

		€			
1/16, 5/64, 3/32, 1/8, 5/32, 3/16, 1/4 in	7	15,89	3	BE-9775	

Aço CROMO-VANADIUM 5/64 3/32 1/4 1/8 1/16 5/32 3/16

Jogo de chaves hexagonais Offset, em esfera, em polegadas, em preto



BE-9780

		€			
0.05 1/16 5/64 3/32 7/64 1/8 9/64 5/32 3/16 7/32 1/4 5/16 in	12	29,29	3	BE-9780	

0.05 1/16 5/64 3/32 7/64 1/8 9/64 5/32 3/16 7/32 1/4 5/16

Jogo de chaves hexagonais Offset, em esfera, em polegadas, em preto



BE-9785

		€			
0.05 1/16 5/64 3/32 7/64 1/8 9/64 5/32 3/16 7/32 1/4 5/16 3/8 in	13	27,13	3	BE-9785	

0.05 1/16 5/64 3/32 7/64 1/8 9/64 5/32 3/16 7/32 1/4 5/16 3/8

PONTAS TORX

Chave parafusos offset TORX. Milímetros, Preto



1995TORX

		€			
T 6	75 mm	6,26	5	1995TORX-T6	
T 7	80 mm	6,26	5	1995TORX-T7	
T 8	80 mm	6,26	5	1995TORX-T8	
T 9	80 mm	5,93	5	1995TORX-T9	
T 10	86 mm	5,07	5	1995TORX-T10	
T 15	90 mm	5,17	5	1995TORX-T15	
T 20	95 mm	5,38	5	1995TORX-T20	
T 25	100 mm	5,40	5	1995TORX-T25	
T 27	105 mm	5,52	5	1995TORX-T27	
T 30	114 mm	5,61	5	1995TORX-T30	
T 40	124 mm	5,88	5	1995TORX-T40	
T 45	133 mm	6,13	5	1995TORX-T45	
T 50	152 mm	6,96	5	1995TORX-T50	
T 55	184 mm	9,89	5	1995TORX-T55	
T 60	204 mm	12,00	5	1995TORX-T60	

Milímetros, Preto

Conjunto Longo TORX® Colorido L-Key - 9 Pcs



C1997TORX/9P

		€			
8, 9, 10, 15, 20, 25, 27, 30, 40	9	36,77	1	C1997TORX/9P	

Jogo Chaves parafusos offset TORX



1995TORX/

		€			
10, 20, 30, 40	4	24,64	1	1995TORX/4T	

1995TORX-T40, 1995TORX-T30, 1995TORX-T10, 1995TORX-T20



Jogo de chaves Offset TORX®, em preto



1995TORX/7T

		€			
10, 15, 20, 25, 27, 30, 40	7	40,18	1	1995TORX/7T	

1995TORX-T20, 1995TORX-T10, 1995TORX-T15, 1995TORX-T27, 1995TORX-T25, 1995TORX-T30, 1995TORX-T40



Jogo de chaves Offset TORX®, em preto



1995TORX/11T

		€			
7, 9, 10, 15, 20, 25, 27, 30, 40, 45, 50	11	67,32	1	1995TORX/11T	

1995TORX-T7, 1995TORX-T9, 1995TORX-T10, 1995TORX-T15, 1995TORX-T20, 1995TORX-T25, 1995TORX-T27, 1995TORX-T30, 1995TORX-T40, 1995TORX-T45, 1995TORX-T50

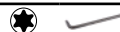

Jogo de chaves Offset TORX®, em preto



1995TORX/13T

		€		
6, 7, 8, 9, 10, 15, 20, 25, 27, 30, 40, 45, 50	13	80,83	1	1995TORX/13T

1995TORX-T45, 1995TORX-T40, 1995TORX-T30, 1995TORX-T27, 1995TORX-T25, 1995TORX-T20, 1995TORX-T15, 1995TORX-T10, 1995TORX-T50, 1995TORX-T8, 1995TORX-T9, 1995TORX-T6, 1995TORX-T7

Jogo Chaves de parafuso offset Torxs 8 peças. Acabamento Preto



BE-9575

		€		
T9, T10, T15, T20, T25, T27, T30, T40	8	46,06	1	BE-9575

Acabamento Preto

1995TORX-T40, 1995TORX-T30, 1995TORX-T27, 1995TORX-T25, 1995TORX-T20, 1995TORX-T15, 1995TORX-T10, 1995TORX-T9

Jogo Chaves de parafuso offset Torx Magnetizado 8 peças. Acabamento Preto



BE-9585

		€		
T9, T10, T15, T20, T25, T27, T30, T40	8	48,85	1	BE-9585

Acabamento Preto

1995TORX-T30, 1995TORX-T27, 1995TORX-T25, 1995TORX-T20, 1995TORX-T15, 1995TORX-T10, 1995TORX-T9, 1995TORX-T40

Chaves de parafusos offset com acabamento em preto para parafusos TORX®. 8pcs



BE-8975B

		€		
T 9 - T 10 - T 15 - T 20 - T 25 - T 27 - T 30 - T 40	8	41,81	6	BE-8975B

8pcs

Conjunto de chaves de parafuso offset TORX®. Aço VANADIUM-EXTRA



BE-8975

		€		
T 9 10 15 20 25 27 30 40	8	41,81	6	BE-8975

Aço VANADIUM-EXTRA

Chave parafusos offset TORX. Ponta Bola, Preto



1996TORX

		€		
T 9	80 mm	7,70	5	1996TORX-T9
T 10	86 mm	8,88	5	1996TORX-T10
T 15	90 mm	9,17	5	1996TORX-T15
T 20	95 mm	9,31	5	1996TORX-T20

		€		
T 25	100 mm	9,46	5	1996TORX-T25
T 27	105 mm	9,52	5	1996TORX-T27
T 30	114 mm	9,97	5	1996TORX-T30
T 40	124 mm	10,63	5	1996TORX-T40
T 45	133 mm	11,14	5	1996TORX-T45
T 50	152 mm	12,62	5	1996TORX-T50

Ponta Bola, Preto

Jogo Chave parafusos offset TORX



1996TORX/

		€		
T10, T20, T25, T30, T40	5	46,89	1	1996TORX/5T

1996TORX-T10, 1996TORX-T20, 1996TORX-T25, 1996TORX-T30, 1996TORX-T40

Jogo Chaves de parafuso offset Torx ponta bola. Acabamento Preto



BE-9675

		€		
T9, T10, T15, T20, T25, T27, T30, T40	8	67,02	1	BE-9675

Acabamento Preto

1996TORX-T10, 1996TORX-T9, 1996TORX-T15, 1996TORX-T20, 1996TORX-T25, 1996TORX-T27, 1996TORX-T30, 1996TORX-T40



Chave parafusos offset TORX.
Acabamento preto



1986TORX

1986TORX	L	€	Icon	Icon
TR 9	80 mm	8,44	5	1986TORX-T9
TR 10	86 mm	8,74	5	1986TORX-T10
TR 15	90 mm	8,96	5	1986TORX-T15
TR 20	95 mm	9,08	5	1986TORX-T20
TR 25	100 mm	9,24	5	1986TORX-T25
TR 27	105 mm	9,31	5	1986TORX-T27
TR 30	114 mm	9,69	5	1986TORX-T30
TR 40	124 mm	10,34	5	1986TORX-T40

Acabamento preto

Jogo Chaves parafusos offset TORX



1986TORX/

1986TORX/	Icon	€	Icon	Icon
TR10, TR15, TR20, TR25, TR27, TR30, TR40	7	68,80	1	1986TORX/7T

1986TORX-T10, 1986TORX-T15,
1986TORX-T20, 1986TORX-T25,
1986TORX-T27, 1986TORX-T30,
1986TORX-T40

Jogo Chaves de parafuso offset Torx.
Acabamento Preto



BE-8675

BE-8675	Icon	€	Icon	Icon
T9, T10, T15, T20, T25, T27, T30, T40	8	75,09	1	BE-8675

Acabamento Preto

1986TORX-T10, 1986TORX-T9,
1986TORX-T20, 1986TORX-T15,
1986TORX-T30, 1986TORX-T40,
1986TORX-T25, 1986TORX-T27

Chaves de parafusos offset com
acabamento em preto para parafusos
TORX®



BE-8976B

BE-8976B	Icon	€	Icon	Icon
T9, T10, T15, T20, T25, T27, T30, T40	8	47,49	6	BE-8976B

Chave parafusos offset TORX PLUS.
Acabamento preto



1976TORX

1976TORX	L	€	Icon	Icon
IP 6	75 mm	7,62	5	1976TORX-T6
IP 7	80 mm	7,62	5	1976TORX-T7
IP 8	80 mm	7,62	5	1976TORX-T8
IP 9	80 mm	7,39	5	1976TORX-T9
IP 10	86 mm	7,71	5	1976TORX-T10
IP 15	90 mm	7,93	5	1976TORX-T15
IP 20	95 mm	8,02	5	1976TORX-T20
IP 25	100 mm	8,13	5	1976TORX-T25
IP 27	105 mm	9,01	5	1976TORX-T27
IP 30	114 mm	9,45	5	1976TORX-T30
IP 40	124 mm	10,09	5	1976TORX-T40

Acabamento preto

Jogo Chaves de parafuso offset TORX



1976TORX/

1976TORX/	Icon	€	Icon	Icon
IP 10, IP 20, IP 25, IP 30, IP 40	5	41,22	1	1976TORX/5T

1976TORX-T10, 1976TORX-T20,
1976TORX-T25, 1976TORX-T40,
1976TORX-T30

Jogo Chaves de parafuso offset Torx Plus
8 peças. Acabamento Preto



BE-7675

BE-7675	Icon	€	Icon	Icon
IP9, IP10, IP15, IP20, IP25, IP27, IP30, IP40	8	62,41	1	BE-7675

Acabamento Preto

1976TORX-T10, 1976TORX-T9,
1976TORX-T15, 1976TORX-T20,
1976TORX-T25, 1976TORX-T30,
1976TORX-T40, 1976TORX-T27

LUNETA DUPLA

Chave de parafuso offset. Fenda



2047

Ø	L	€	Box	Icon
4.0 mm	100 mm	6,37	5	2047-0.8-4
5.5 mm	125 mm	7,77	5	2047-1-5.5
8.0 mm	150 mm	9,95	5	2047-1.2-8
10.0 mm	175 mm	13,66	1	2047-1.6-10
12.0 mm	200 mm	19,91	1	2047-2-12

Fenda

Chave de parafuso offset. PHILLIPS®



2047PR

Ø	L	€	Box	Icon
PH 1 & 2	100 mm	8,00	5	2047PR-1-2
PH 3 & 4	200 mm	13,22	5	2047PR-3-4

PHILLIPS®

Chave de parafusos offset para parafusos Pozidriv



2047PZ

Icon	L	€	Box	Icon
PZ1, PZ2	100 mm	8,19	5	2047PZ-1-2

MULTIFERRAMENTAS

Jogo de bolso especial para bicicletas



BKE850901N

Icon	€	Box	Icon
200 x 35 x 170 mm	14,99	10	BKE850901N





BAHCO



Alicates



ALICATES DE CORTE

Alicate de corte lateral - fosfatado. Arame de piano e Arame de cobre



ergo®



2101G

Cu	Fer	Plano	€		
3.5 mm	1.8 mm	1.6 mm	24,00	5	2101G-125
3.7 mm	2.0 mm	1.8 mm	24,42	5	2101G-140
3.8 mm	2.5 mm	2.0 mm	24,92	5	2101G-160
4.0 mm	2.7 mm	2.3 mm	26,66	5	2101G-180
3.5 mm	1.8 mm	1.6 mm	22,42	5	2101G-125IP
3.7 mm	2.0 mm	1.8 mm	22,83	5	2101G-140IP
3.8 mm	2.5 mm	2.0 mm	23,37	5	2101G-160IP
4.0 mm	2.7 mm	2.3 mm	25,04	5	2101G-180IP

Arame de piano e Arame de cobre

Alicate crt lateral c/bordo progr. s/função on/off da mola. P/corda piano e mat. + macios c/o cobre ou plástico



ergo®



2101G_D

Cu	Fer	Plano	€		
3.5 mm	1.8 mm	1.6 mm	22,42	5	2101G-125IPD
3.7 mm	2.0 mm	1.8 mm	22,83	5	2101G-140IPD
3.8 mm	2.5 mm	2.0 mm	23,37	5	2101G-160IPD
4.0 mm	2.7 mm	2.3 mm	25,04	5	2101G-180IPD

Alicate de corte lateral - fosfatado. Especial para plástico



ergo®



2101PG

L	€		
160 mm	53,99	5	2101PG-160

Especial para plástico

Alicate de corte lateral - cromado. Arame de piano e Arame de cobre



ergo®



2101GC

Cu	Fer	Plano	€		
3.5 mm	1.8 mm	1.6 mm	22,78	5	2101GC-125IP
3.7 mm	2.0 mm	1.8 mm	22,90	5	2101GC-140IP
3.8 mm	2.5 mm	2.0 mm	23,85	5	2101GC-160IP
4.0 mm	2.7 mm	2.3 mm	25,99	5	2101GC-180IP

Arame de piano e Arame de cobre

Alicate de corte lateral - fosfatado. Arame de piano e cobre - Cabo revestido a PVC



2101D

Cu	Fer	Plano	€		
3.5 mm	1.8 mm	1.6 mm	20,07	5	2101D-125
3.7 mm	2.0 mm	1.8 mm	20,07	5	2101D-140
3.8 mm	2.5 mm	2.0 mm	20,41	5	2101D-160
4.0 mm	2.7 mm	2.3 mm	22,20	5	2101D-180
3.5 mm	1.8 mm	1.6 mm	18,48	5	2101D-125IP
3.7 mm	2.0 mm	1.8 mm	18,48	5	2101D-140IP
3.8 mm	2.5 mm	2.0 mm	18,80	5	2101D-160IP
4.0 mm	2.7 mm	2.3 mm	20,60	5	2101D-180IP

Arame de piano e cobre - Cabo revestido a PVC

Alicate de corte lateral para trabalho pesado/industria. Para arame de piano e arame duro



ergo®



21HDG

Fer	Plano	L	€		
2.3 mm	2.1 mm	140 mm	26,99	5	21HDG-140
2.7 mm	2.3 mm	160 mm	27,70	5	21HDG-160
3.3 mm	2.8 mm	180 mm	30,36	5	21HDG-180
3.3 mm	2.8 mm	200 mm	32,29	5	21HDG-200
2.3 mm	2.1 mm	140 mm	25,40	5	21HDG-140IP
2.7 mm	2.3 mm	160 mm	26,11	5	21HDG-160IP
3.3 mm	2.8 mm	180 mm	28,77	5	21HDG-180IP
3.3 mm	2.8 mm	200 mm	30,71	5	21HDG-200IP

Para arame de piano e arame duro

Alicate de corte lateral com ângulo de 14 graus para trabalho pesado/ indústria. Para arame de piano e arame duro



ergo®



21HDG-A

Fer	Piano	L	€		
2.2 mm	2.0 mm	140 mm	28,63	5	21HDG-140A
2.5 mm	2.3 mm	160 mm	29,76	5	21HDG-160A
2.7 mm	2.5 mm	180 mm	32,61	5	21HDG-180A
3.2 mm	3.0 mm	200 mm	34,77	5	21HDG-200A

Para arame de piano e arame duro

Alicate cromado de corte lateral para trabalho pesado/ indústria. Para arame de piano e arame duro



ergo®



21HDGC

Fer	Piano	L	€		
2.2 mm	2.2 mm	140 mm	26,58	5	21HDGC-140IP
2.5 mm	2.5 mm	160 mm	27,66	5	21HDGC-160IP
2.8 mm	2.8 mm	180 mm	30,04	5	21HDGC-180IP
3.2 mm	3.0 mm	200 mm	31,59	5	21HDGC-200IP

Para arame de piano e arame duro

Alicate de corte lateral para trabalho pesado/ indústria para arame de piano e arame de aço. Para arame de piano e arame duro



21HDD

Fer	Piano	L	€		
2.2 mm	2.2 mm	140 mm	22,93	5	21HDD-140
2.5 mm	2.5 mm	160 mm	23,53	5	21HDD-160
2.8 mm	2.8 mm	180 mm	25,73	5	21HDD-180
3.2 mm	3.0 mm	200 mm	28,17	5	21HDD-200
2.2 mm	2.2 mm	140 mm	21,34	5	21HDD-140IP
2.5 mm	2.5 mm	160 mm	21,97	5	21HDD-160IP
2.8 mm	2.8 mm	180 mm	24,13	5	21HDD-180IP
3.2 mm	3.0 mm	200 mm	26,57	5	21HDD-200IP

Para arame de piano e arame duro

Alicate de corte frontal. Arame de piano



1520G

Piano	L	€		
3.8 mm	210 mm	38,87	5	1520 G
3.8 mm	210 mm	38,77	5	1520 G IP

Arame de piano

Alicate de corte frontal. Arame de piano, Cabo revestido a PVC



1520D

Piano	L	€		
3.8 mm	205 mm	43,84	5	1520 D

Arame de piano, Cabo revestido a PVC

Alicate de corte lateral



ergo®



4130, 4131





Fer	L	€		
0.3-1.5 mm	120 mm	47,87	3	4130
0.3-1.5 mm	120 mm	47,87	3	4131



Alicate de corte lateral, cabeça oval



C3140

		€		
0,4-2,0 mm	130 mm	36,36	10	C3140
0,4-2,0 mm	130 mm	35,95	10	C3140IP

Alicate de corte lateral para plástico. Corte de precisão



2100PD

PLASTIC





			€		
1.8 mm	3.0 mm	150 mm	31,36	5	2100PD-150

Corte de precisão

Alicate de corte lateral, cabeça cônica







C3330

		€		
0,3-1,6 mm	115 mm	35,29	10	C3330
0,3-1,6 mm	115 mm	34,88	10	C3330IP

Alicate de corte lateral







2171G

			€		
2.5 mm	1.6 mm	1.5 mm	18,87	5	2171G-140
2.5 mm	1.6 mm	1.5 mm	19,47	5	2171G-160
2.5 mm	1.6 mm	1.5 mm	21,49	5	2171G-180

Alicate de corte lateral, cabeça cônica e em relevo



C3330R/C3340R

		€		
0,3-1,25 mm	115 mm	35,29	10	C3330R
0,3-1,25 mm	115 mm	34,88	10	C3330R IP
0,4-1,6 mm	130 mm	36,19	10	C3340R
0,4-1,6 mm	130 mm	36,24	10	C3340R IP

Alicate de corte lateral - níquelado e cromado. Arame de aço



2666NB-2676NB

			€		
2.7 mm	2.0 mm	160 mm	82,39	1	2674 NB

Arame de aço

Alicate de corte lateral - niquelado e cromado. Arame de piano



2667B-2678B

0.1-1.0 mm	0.2-1.25 mm	0.4-2.0 mm	0.3-1.6 mm	€	Quantidade	Modelo
3.7 mm	2.0 mm	2.0 mm	2.0 mm	85,24	1	2676 B
4.0 mm	2.5 mm	2.5 mm	2.5 mm	95,22	1	2678 B

Arame de piano

0.1-1.0 mm	0.2-1.25 mm	0.4-2.0 mm	0.3-1.6 mm	€	Quantidade	Modelo
Ultra-flush	Ultra-flush	Micro-bevel	Ultra-flush	89,31	1	2646 AK
				96,00	1	2666 FK
				77,28	1	2648
				110,33	1	2648 A

Cabeça cônica

Alicate de corte diagonal. Cabeça oval



2646M - 2649

0.1-0.8 mm	0.2-1.25 mm	0.2-1.25 mm	0.1-1.0 mm	0.3-1.6 mm	0.4-2.0 mm	€	Quantidade	Modelo
Flush	Micro-bevel	Micro-bevel	Flush	Micro-bevel	Micro-bevel	90,63	1	2646 M
						76,82	1	2646 R
						116,15	1	2646 RK
						90,77	1	2646 RA
						81,78	1	2666
						87,60	1	2649

Cabeça oval

Alicate de corte diagonal. Cabeça cônica



2646 - 2648A

0.2-1.25 mm	0.2-1.25 mm	0.1-1.0 mm	€	Quantidade	Modelo
Micro-bevel	Micro-bevel	Ultra-flush	81,78	1	2646
			92,61	1	2646 K
			93,07	1	2646 A

Alicate de corte oblíquo 20°



ergo®



4231

0.3-1.25 mm	€	Quantidade	Modelo
119 mm	65,81	3	4231

Alicate de corte oblíquo 45°



ergo®



4239

0.3-1.0 mm	€	Quantidade	Modelo
129 mm	64,54	3	4239



Alicate de corte lateral. Corte de precisão, ponta de corte em 45°



2145PD

PLASTIC

			€		
3.0 mm	1.8 mm	154 mm	50,54	5	2145PD-150

Corte de precisão, ponta de corte em 45°

Alicate de corte oblíquo 45°. Cabeça longa



2787F

			€		
0.2-1.0 mm	Flush	117.5 mm	120,36	1	2787 F

Cabeça longa

Alicate de corte oblíquo 45°. Cabeça longa e em relevo



2787G

			€		
0.2-0.8 mm	Flush	117.5 mm	131,42	1	2787 G

Cabeça longa e em relevo

Alicate de corte frontal cromado para fios de piano



527 GC

		€		
2.0 mm	160 mm	32,93	3	527 GC-160
2.5 mm	200 mm	39,32	3	527 GC-200

Alicate de corte frontal - fosfatado. Arame de piano



527D

		€		
2 mm	160 mm	26,42	5	527 D-160
2.5 mm	200 mm	31,56	5	527 D-200

Arame de piano

Alicate de corte frontal - fosfatado. Arame de ferro, cabo revestido PVC



2339D

		€		
2.2 mm	220 mm	20,18	3	2339 D
2.2 mm	220 mm	19,51	5	2339 DIP
4.5 mm	300 mm	24,44	5	2339D-300
4.5 mm	300 mm	23,85	6	2339D-300IP

Arame de ferro, cabo revestido PVC

Alicate de corte frontal - fosfatado. Arame de ferro



2339

		€		
2.2 mm	220 mm	16,09	5	2339-220
2.2 mm	220 mm	15,50	5	2339-220IP
2.5 mm	250 mm	17,43	5	2339-250IP
3.0 mm	280 mm	19,83	5	2339-280IP
4.5 mm	300 mm	26,50	6	2339-300IP

Arame de ferro

Tenazes - fosfatado. Arame de ferro, Cabo revestido PVC.



541D

		€		
2.0 mm	150 mm	16,62	5	541 D-150
2.0 mm	180 mm	17,81	5	541D-180
2.5 mm	200 mm	18,89	5	541 D-200
2.5 mm	225 mm	21,77	5	541D-225
2.5 mm	250 mm	24,77	5	541 D-250

Arame de ferro, Cabo revestido PVC.

Alicate de corte frontal - fosfatado. Arame de piano



1519D

		€		
2.5 mm	230 mm	121,97	3	1519 D
		60,79	1	1519-9

Arame de piano

Alicate de corte frontal



C3230

	€		
109 mm	49,18	10	C3230
109 mm	48,70	10	C3230IP

Alicate corte para plástico. Ângulo Corte 90°



2190PD

			€		
1.8 mm	3.0 mm	143 mm	53,43	5	2190PD-150

Ângulo Corte 90°

Alicate de corte frontal



2656/2656A

			€		
0.35 - 0.8 mm	Micro	115 mm	84,98	1	2656



Corta cabos e descarnador. Arame de cobre, alumínio



2233D

Øa	↓	← L →	€	☐	☉
10 mm	50/35 mm	160 mm	33,36	5	2233 D-160
13 mm	70/50 mm	200 mm	40,98	5	2233 D-200
16 mm	95/70 mm	240 mm	46,23	5	2233 D-240
10 mm	50/35 mm	160 mm	32,68	5	2233D-160IP
13 mm	70/50 mm	200 mm	40,29	5	2233D-200IP
16 mm	95/70 mm	240 mm	45,55	5	2233D-240IP

Arame de cobre, alumínio

Corta cabos. Alumínio e cobre



2520

← L →	€	☐	☉
550 mm	175,48	1	2520

Alumínio e cobre

Corta cabos para o corte de cablagem em alumínio/cobre, sem arame condutor



2620-80

↓	← L →	€	☐	☉
42 mm	800 mm	283,66	1	2620-80

Corta cabos aço.



2720

↓	← L →	€	☐	☉
42 mm	600 mm	243,06	1	2720
	163 mm	185,86	1	2720-SH

Alicate corte cabos aço.



2235-160

← L →	€	☐	☉
165 mm	50,46	1	2235-160

Corta cabos com roquete. Cobre e Alumínio



2804-2805

↓	↓	← L →	€	☐	☉
16 mm	34 mm	250 mm	436,26	1	2804
22 mm	52 mm	280 mm	510,21	1	2805-280

Cobre e Alumínio

Corta cabos. Arame de cobre revestido em PVC



2800N-2801N

		€		
0-10 mm	170 mm	69,98	1	2800 N
0-15 mm	230 mm	86,23	1	2801 N

Arame de cobre revestido em PVC

Corta cabos



4559

			€		
6 mm	5 mm	4 mm	87,34	1	4559-12
8 mm	7 mm	6 mm	108,60	8	4559-18
10 mm	9 mm	8 mm	129,39	6	4559-24
13 mm	10 mm	9 mm	155,58	5	4559-30
15 mm	12 mm	11 mm	204,21	3	4559-36
15 mm	12 mm	11 mm	286,15	2	4559-42

Cabeça de corte para 4559 JC



4559 JC

	€		
285 g	53,77	1	4559-12A JC
600 g	69,51	1	4559-18B JC
930 g	82,81	1	4559-24B JC
1260 g	99,57	1	4559-30B JC
2180 g	130,70	1	4559-36B JC
3025 g	126,49	1	4559-42A JC

Corta cabos diagonal



4560-210

	€		
250 mm	55,73	1	4560-210

ALICATES UNIVERSAIS

Alicates universais ERGO™ com pegas de dois componentes e abertura automática e acabamento em fosfato



2628G

			€		
1.8 mm	2.0 mm	160 mm	24,76	5	2628 G-160
2.0 mm	2.5 mm	180 mm	27,17	5	2628 G-180
2.5 mm	3.0 mm	200 mm	28,98	5	2628 G-200
1.8 mm	2.0 mm	160 mm	24,06	5	2628 G-160IP
2.0 mm	2.5 mm	180 mm	26,50	5	2628 G-180IP
2.5 mm	3.0 mm	200 mm	28,30	5	2628G-200IP

Alicates universais ERGO™ com pegas de dois componentes e abertura automática e acabamento em cromado



2628GC

			€		
2.0 mm	1.8 mm	160 mm	19,20	5	2628 GC-160IP
2.5 mm	2.0 mm	180 mm	20,74	5	2628 GC-180IP
3.0 mm	2.5 mm	200 mm	22,81	5	2628 GC-200IP



Alicates universais reforçados ERGO™ com pegas de dois componentes e abertura automática e acabamento em cromado



ergo®



2630GC

Plano	Fe*	L	€		
1.8 mm	2.0 mm	160 mm	19,79	5	2630GC-160IP
2.0 mm	2.5 mm	180 mm	19,94	5	2630GC-180IP
2.5 mm	3.0 mm	200 mm	22,81	5	2630GC-200IP

Ponta de corte

Alicates de pontas universais ERGO™ com pegas de dois componentes e abertura automática e acabamento em fosfato



ergo®



2629G

L	Fe*	Plano	€		
160 mm	2.0 mm	1.8 mm	24,76	5	2629G-160
180 mm	3.0 mm	2.5 mm	27,09	5	2629G-180
200 mm	2.5 mm	2.0 mm	28,98	5	2629G-200
160 mm	2.5 mm	2.0 mm	24,06	5	2629G-160IP
180 mm	2.0 mm	1.8 mm	26,50	5	2629G-180IP
200 mm	3.0 mm	2.5 mm	28,30	5	2629G-200IP

Alicates universais com pegas de monomaterial e acabamento em fosfato



2628D

Fe*	Plano	L	€		
2.0 mm	1.8 mm	160 mm	20,81	5	2628 D-160
2.5 mm	2.0 mm	180 mm	23,80	5	2628 D-180
3.0 mm	2.5 mm	200 mm	25,04	5	2628 D-200

Cabo revestido a PVC

Alicates universais reforçados com pegas de monomaterial e acabamento cromado



2630DC

Fe*	Plano	L	€		
2.0 mm	1.8 mm	160 mm	17,89	5	2630DC-160IP
2.5 mm	2.0 mm	180 mm	19,08	5	2630DC-180IP
3.0 mm	2.5 mm	200 mm	21,93	5	2630DC-200IP

Pontas de corte

Alicate universal, modelo Linesman. Linesman



2640D

Cu	Fe	Fe*	€		
3.0 mm	2.7 mm	2.5 mm	19,22	10	2640D-160
3.0 mm	2.7 mm	2.5 mm	21,78	5	2640D-180
3.5 mm	3.0 mm	2.5 mm	24,47	5	2640D-200

Linesman

Alicate universal para electricista



2688D

Fe*	Fe	Cu	€		
2.5 mm	3.0 mm	3.5 mm	41,56	3	2688D-250

Alicate universal



2678G

			€		
1.7 mm	1.3 mm	160 mm	16,08	5	2678 G-160
2.0 mm	1.4 mm	180 mm	17,10	5	2678 G-180
2.5 mm	1.5 mm	205 mm	18,48	5	2678 G-200

Alicate de duas posições



2970 G-200

	€		
200 mm	17,24	5	2970G-200

ALICATES DE PREENSÃO

Alicates de pontas compridas ERGO™ com pegas de dois componentes e abertura automática e acabamento em fosfato



ergo®



2430G

			€		
2.5 mm	1.8 mm	1.4 mm	27,09	5	2430 G-140
3.0 mm	1.8 mm	1.6 mm	28,61	5	2430 G-160
3.0 mm	1.8 mm	1.6 mm	32,82	5	2430 G-200
2.5 mm	1.8 mm	1.4 mm	26,41	5	2430 G-140 IP
3.0 mm	1.8 mm	1.6 mm	27,91	5	2430 G-160 IP
3.0 mm	1.8 mm	1.6 mm	32,13	5	2430 G-200 IP

Arame de aço

Alicates de pontas compridas ERGO™ com pegas de dois componentes e abertura automática e acabamento em cromado



ergo®



2430GC

			€		
2.5 mm	1.8 mm	1.4 mm	22,58	5	2430 GC-140 IP
3.0 mm	1.8 mm	1.6 mm	23,61	5	2430 GC-160 IP
3.0 mm	1.8 mm	1.6 mm	27,18	5	2430 GC-200 IP

Arame de aço

Alicates de pontas longas com pegas de monomaterial e acabamento em fosfato



2430D

			€		
2.5 mm	1.8 mm	1.4 mm	23,96	5	2430 D-140
3.0 mm	1.8 mm	1.6 mm	25,85	5	2430 D-160
3.0 mm	1.8 mm	1.6 mm	28,02	5	2430 D-200
2.5 mm	1.8 mm	1.4 mm	23,30	5	2430 D-140 IP
3.0 mm	1.8 mm	1.6 mm	25,13	5	2430 D-160 IP
3.0 mm	1.8 mm	1.6 mm	27,33	5	2430 D-200 IP

Arame de aço - Cabo revestido a PVC

Alicates de pontas compridas ERGO™ com extremidade de corte, pegas de dois componentes e abertura automática e acabamento em fosfato



ergo®



2431G

	€		
125 mm	25,58	5	2431G-125
140 mm	26,11	5	2431G-140
160 mm	26,58	5	2431G-160
180 mm	27,55	5	2431G-180
125 mm	25,10	5	2431G-125IP
140 mm	25,55	5	2431G-140IP
160 mm	25,99	5	2431G-160IP
180 mm	26,82	5	2431G-180IP



Alicate de pontas



ergo



4830, 4831

L	€		
135 mm	42,75	3	4830
135 mm	45,46	3	4831

Alicate de ponta chata



2656S

L	€		
132 mm	65,15	1	2656 S

Alicate de pontas



C3830/C3840

L	€		
121 mm	36,95	10	C3830
121 mm	36,22	10	C3830IP
144 mm	36,95	10	C3840
144 mm	36,24	10	C3840IP

Alicate de pontas semi circular



2470G

Cu	Fe	Plano	€		
3.0 mm	1.5 mm	1.0 mm	18,30	5	2470 G-160
3.0 mm	1.5 mm	1.0 mm	20,33	5	2470 G-200

Alicate de pontas finas



C3630/C3640

L	€		
130 mm	41,13	10	C3630
130 mm	40,30	10	C3630IP
145 mm	42,33	10	C3640
145 mm	41,37	10	C3640IP

Alicate de boca semicircular plana



158-N

L	€		
280 mm	37,14	12	158-N

Alicates de pontas 45° ERGO™ com pegas de dois componentes e abertura automática e acabamento em fosfato



ergo®



2427G

			€		
3.0 mm	1.8 mm	1.6 mm	29,47	5	2427 G-160
3.0 mm	1.8 mm	1.6 mm	33,70	5	2427 G-200
3.0 mm	1.8 mm	1.6 mm	28,77	5	2427 G-160 IP
3.0 mm	1.8 mm	1.6 mm	33,03	5	2427 G-200 IP

Arame de aço

Alicates de pontas 45° ERGO™ com pegas de dois componentes e abertura automática e acabamento em cromado



ergo®



2427GC

			€		
3.0 mm	1.8 mm	1.6 mm	24,56	5	2427 GC-160IP
3.0 mm	1.8 mm	1.6 mm	28,14	5	2427 GC-200IP

Arame de aço

Alicates de pontas de 45° com pegas em monomaterial e acabamento em fosfato



2427D

			€		
3.0 mm	1.8 mm	1.6 mm	27,01	5	2427 D-160
3.0 mm	1.8 mm	1.6 mm	29,20	5	2427 D-200

Arame de aço - Cabo revestido a PVC

Alicate de pontas semi-redondas e dobradas 60°



ergo®



4833

	€		
130 mm	47,00	3	4833

Alicate de pontas finas, ponta dobrada de 45°



C3745

	€		
141 mm	39,16	10	C3745
141 mm	38,51	10	C3745IP

Alicate de pontas finas, ponta dobrada de 90°



C3790

	€		
125 mm	39,52	10	C3790
125 mm	38,51	10	C3790IP



Alicate de pontas semi-redondas e dobradas



2656R

↔ L ↔	€		
129 mm	81,35	1	2656 R



Alicate de boca semicircular, curvo



2477G-200

			€		
3.0 mm	1.5 mm	1 mm	17,88	5	2477G-160
3.0 mm	1.5 mm	1 mm	22,66	5	2477 G-200

Alicate de boca semicircular curva. Com pontas em ângulo de 35°



158-NB

↔ L ↔	€		
270 mm	38,64	12	158-NB

Com pontas em ângulo de 35°

Alicates de pontas planas e curtas ERGO™ com pegas de dois componentes e abertura automática e acabamento em fosfato



ergo



2420G

↔ L ↔	€		
125 mm	26,36	5	2420 G-125
125 mm	21,34	5	2420G-125IP

Alicates de pontas planas e compridas ERGO™ com pegas de dois componentes e abertura automática e acabamento em fosfato



ergo



2421G

↔ L ↔	€		
140 mm	27,86	5	2421 G-140
160 mm	30,62	5	2421 G-160
180 mm	36,78	5	2421 G-180
140 mm	27,16	5	2421 G-140IP
160 mm	29,90	5	2421 G-160 IP
180 mm	36,08	5	2421 G-180 IP

Alicates de pontas planas e compridas ERGO™ com pegas de dois componentes e abertura automática e acabamento em cromado



ergo



2421GC

↔ L ↔	€		
140 mm	22,78	5	2421GC-140IP
160 mm	25,04	5	2421GC-160IP
180 mm	25,39	5	2421GC-180IP

Alicates de pontas planas e curtas com pegas de monomaterial e acabamento em fosfato



2421D

↔ L ↔	€		
140 mm	22,81	5	2421 D-140IP
160 mm	25,14	5	2421 D-160IP
180 mm	29,99	5	2421 D-180IP

Cabo revestido a PVC

Alicates de conectores ERGO™ com pegas de dois componentes e abertura automática e acabamento em fosfato



7835G

			€		
3.0 mm	1.8 mm	1.6 mm	44,50	5	7835 G-160

Alicate de ponta chata



4430

↔ L ↔	€		
135 mm	41,08	3	4430

Alicate de pontas chatas



C3430

↔ L ↔	€		
129 mm	36,60	10	C3430
129 mm	36,19	10	C3430IP

Alicate de ponta chata



2646MF

↔ L ↔	€		
120 mm	70,59	1	2646 MF

Alicate de boca plana



2471G

↔ L ↔	€		
165 mm	16,75	5	2471 G-160



Alicate para porcas



2979D

	€		
180 mm	41,08	5	2979 D-180

Alicates de pontas curvas ERGO™ com pegas de dois componentes e abertura automática e acabamento em fosfato



2521G

	€		
140 mm	27,65	5	2521 G-140
160 mm	30,47	5	2521G-160
140 mm	28,02	5	2521G-140IP
160 mm	28,59	5	2521 G-160 IP

Alicates de pontas curvas com pegas de monomaterial e acabamento em fosfato



2521D

	€		
140 mm	19,98	5	2521D-140IP
160 mm	23,54	5	2521D-160IP

Cabo revestido a PVC

Alicate de pontas redondas



4530

	€		
135 mm	43,35	3	4530

Alicate de pontas redondas



C3530

	€		
127 mm	36,95	10	C3530
127 mm	36,19	10	C3530IP

Alicate de pontas finas semi-redondas



2646MS

	€		
120 mm	78,26	1	2646 MS

ALICATES DE BOMBAS DE ÁGUA

Alicate bomba de água



ergo®



8223 - 8226



↔ L ↔	€	📦	🐟
210 mm	47,00	4	8223
250 mm	55,34	4	8224
315 mm	75,65	4	8225
400 mm	84,27	1	8226
210 mm	46,33	4	8223 IP
250 mm	54,67	4	8224 IP
315 mm	74,98	4	8225 IP

Alicate de Bomba de Água Cromado



ergo®



8224/8225C



↔ L ↔	€	📦	🐟
250 mm	34,93	4	8224CIP
315 mm	46,61	4	8225CIP

Alicate bomba de água, curto



ergo®



8231



↔ L ↔	€	📦	🐟
51 mm	49,64	4	8231
51 mm	48,97	4	8231 IP

Alicates de bomba de água



7223-7225

↔ L ↔	€	📦	🐟
45 mm	33,32	4	7223
63 mm	34,43	4	7224
70 mm	43,35	8	7225
45 mm	31,59	8	7223IP
63 mm	32,79	4	7224IP
70 mm	41,72	4	7225IP

Alicate de bomba de água de ajuste rápido com pega em PVC



7223D 7225D

↔ L ↔	€	📦	🐟
16	32,19	8	7223D
25	42,33	4	7225D
16	31,00	8	7223D IP
25	41,37	4	7225D IP

Alicate de bomba de água com junta deslizante e pega de dois componentes



6224

↔ L ↔	€	📦	🐟
11	32,19	4	6224



Alicate de bomba de água com caixa de junção e pega em PVC



6221D-6225D

		€		
6	125 mm	20,86	10	6221D
8	150 mm	22,17	10	6222D
10	200 mm	22,66	8	6223D
11	250 mm	20,27	5	6224D
13	300 mm	35,79	10	6225D
6	125 mm	20,50	10	6221D IP
8	150 mm	21,78	10	6222D IP
10	200 mm	22,30	8	6223D IP
11	250 mm	19,88	5	6224D IP
13	300 mm	35,38	5	6225D IP

Alicate articulado



2971G

		€		
35 mm	250 mm	15,53	5	2971G-250

Alicate bomba de água Cabo PVC



221 D - 225 D

	€		
117 mm	14,72	5	221 D
150 mm	15,22	5	222 D
192 mm	16,22	5	223 D
240 mm	18,29	5	224 D
305 mm	27,98	5	225 D

Alicate Bomba de Água



5223 - 5226 DC

		€		
105 mm	400 mm	54,75	1	5226 DC

Alicate de conectores



2650

		€		
65 mm	235 mm	72,70	1	2650
	235 mm	6,47	1	2650 B

Conjunto de alicates de bomba de água com caixa de junção - 3 peças



622-3P

			€		
110 x 50 x 390 mm	3	1260 g	91,68	1	622-3P

6223D, 6224D, 6225D



Conjunto de alicates de bomba de água - 3 peças



7224-622XD-3P

			€		
75 x 50 x 260 mm	3	813 g	88,03	1	7224-622XD-3P

			€		
40-100 mm	2.2 mm	210 mm	29,20	3	2890-210
85-165 mm	3.1 mm	300 mm	43,62	1	2890-300

Alicate para freios interiores



2461

			€		
8-25 mm	1.0-2.0 mm	140 mm	71,36	1	2461 C8
19-60 mm	2.0-2.5 mm	180 mm	73,95	1	2461 C19
40-100 mm	2.5-3.5 mm	255 mm	85,06	1	2461 C40

ALICATE PARA FREIOS

Alicate para freios interiores



2800

			€		
8-13 mm	0.8 mm	140 mm	19,69	3	2800-140
12-25 mm	1.2 mm	150 mm	19,69	3	2800-150
19-60 mm	1.7 mm	180 mm	22,48	3	2800-180
40-100 mm	2.2 mm	225 mm	28,30	3	2800-225
85-165 mm	3.1 mm	310 mm	38,80	1	2800-300

Alicate para freios interiores



2890

			€		
8-15 mm	0.8 mm	127 mm	17,07	3	2890-125
12-25 mm	1.2 mm	127 mm	20,00	3	2890-140
19-60 mm	1.7 mm	180 mm	23,20	3	2890-180

Alicate para freios interiores



2463

			€		
8-25 mm	1.0-2.0 mm	130 mm	62,29	1	2463 D8
19-60 mm	2.0-2.5 mm	170 mm	75,85	1	2463 D19
40-100 mm	2.5-3.5 mm	210 mm	87,19	1	2463 D40



Ferramentas de reparação



2900

Ø	+	L	€	Icon 1	Icon 2
3-10 mm	0.8 mm	140 mm	21,00	3	2900-140
10-25 mm	1.2 mm	150 mm	21,00	3	2900-150
19-60 mm	1.7 mm	180 mm	22,92	3	2900-180
40-100 mm	2.2 mm	215 mm	28,30	3	2900-215
85-165 mm	3.1 mm	300 mm	44,22	1	2900-300

Alicate para freios exteriores



2990

Ø	+	L	€	Icon 1	Icon 2
3-10 mm	0.8 mm	12 mm	21,51	3	2990-125
10-25 mm	1.2 mm	127 mm	21,51	3	2990-140
19-60 mm	1.7 mm	180 mm	24,17	3	2990-180
40-100 mm	2.2 mm	200 mm	29,20	3	2990-200
85-165 mm	3.1 mm	300 mm	43,05	1	2990-300

Alicate para freios exteriores



2464

Ø	+	L	€	Icon 1	Icon 2
3-10 mm	1.0-1.5 mm	120 mm	77,10	1	2464 A3
10-25 mm	1.5-2.0 mm	120 mm	77,10	1	2464 A10
19-60 mm	2.0-2.5 mm	180 mm	83,87	1	2464 A19
40-100 mm	2.5-3.0 mm	210 mm	92,02	1	2464 A40

Alicate para freios exteriores



2466

Ø	+	L	€	Icon 1	Icon 2
3-10 mm	1.0-1.5 mm	130 mm	78,60	1	2466 B3
10-25 mm	1.5-2.0 mm	130 mm	78,60	1	2466 B10
19-60 mm	2.0-2.5 mm	165 mm	85,90	1	2466 B19
40-100 mm	2.5-3.0 mm	190 mm	96,73	1	2466 B40

Alicate reversível para freios interiores e exteriores



2928

Ø	Ø	L	€	Icon 1	Icon 2
7-26 mm	3-26 mm	160 mm	57,14	1	2928-160
10-51 mm	7-51 mm	200 mm	80,66	1	2928-200
46-102 mm	38-102 mm	250 mm	115,36	1	2928-250

Alicate reversível para freios interiores e exteriores



2928-1 - 4

Icon	€	Icon 1	Icon 2
2928-160	15,38	1	2928-1
2928-200	15,38	1	2928-2
2928-250	15,38	1	2928-3
2928-250	15,38	1	2928-4

Alicate para freios exteriores



2460

	€		
175 mm	52,85	1	2460

Alicate especial para freios cegos



2465D

	€		
200 mm	58,81	1	2465D-200

Conjunto Alicates Freios 4 peças



28-29/S4

	€		
740 g	107,34	1	28-29/S4

2900-180				
2800-180				
2990-180				
2890-180				

Jogo de alicates reversíveis. Para freios interiores e exteriores



9938

	€		
1640 g	216,20	1	9938

Para freios interiores e exteriores

2928-160, 2928-200, 2928-250				
------------------------------	--	--	--	--

DESCARNADORES E FERRAMENTAS DE DESMONTAGEM

Alicates para descarnar ERGO™ com pegas de dois componentes e abertura automática e acabamento em fosfato



2223G

		€		
0.5-5 mm	165 mm	28,61	5	2223 G-150

Arame de cobre e cablagem



Alicates para descarnar com pegas em monomaterial e acabamento em fosfato



2223D

		€		
0,5-5 mm	165 mm	29,12	5	2223 D-150

Arame de cobre e cablagem

Alicates automático descarnadores de cabos



3416 B

		€		
0,02-10 mm ²	34-8 AWG	152,71	10	3416 B
		59,49	10	3416 B SH

Alicate automático para descarnar



3416 A

		€		
0,2-6 mm ²	24-10 AWG	44,09	6	3416 A
		16,68	1	3416 A SH

Alicate automático para descarnar



3418 A

			€		
20-10 AWG	0,5-6 mm ²	3 mm	35,19	1	3418 A

Ferramenta de desmantelamento rotativa



3520 B

		€		
4,5-40 mm	167 mm	103,61	10	3520 B
		29,69	10	3520 B SH

Ferramenta rotativa para descarnar



3520 A

	€		
0,5-6 mm ²	33,74	1	3520 A
	5,67	1	3520 A SH

3519 ASH: reserveblad, rett, 3519 ASHB: Reserveblad, bøyd

Ferramenta rotativa para descarnar. 3518ASH lâmina sobresselente



3518 A

		€		
4-28 mm	185 mm	24,33	1	3518 A
		5,70	1	3518 A SH

3518ASH lâmina sobresselente

Ferramenta de desmantelamento com lâmina oculta



3518 B

		€		
0,5-6 mm ²	125 mm	44,35	1	3518 B

Ferramenta de desmantelamento rotativa com faca externa



3517 A

		€		
6-13 mm	120 mm	34,89	1	3517 A

Ferramenta de descarnar para cabos de dados PVC



3717 A

			€		
115 mm	4.5-10 mm mm	28 g	27,56	1	3717 A

Descarnador para cabos coaxiais



3417 A

		€		
4.8-7.5 mm	110 mm	29,15	12	3417 A

Ferramenta de desmantelamento rotativa com faca externa



3619 A

		€		
2,5-11 mm	91 mm	52,34	10	3619 A
		14,19	10	3619 A SH



Ferramenta de decapagem de precisão



3719 A

			€		
0,12-0,8 mm	36-20 AWG	112 mm	39,37	12	3719 A

Ferramenta de inserção para blocos LSA



3718 A

			€		
185 mm	0,7-2,6 mm	60 g	51,18	12	3718 A

Alicate de descarnar auto-regulável. 3419EB: lâmina de substituição



3419 B

	€		
0.25-6.00 mm	119,31	1	3419 B
	36,18	1	3419 B SH

3419EB: lâmina de substituição

ALICATES DE CRAVAR

Alicates de cravar, com operação de corte e descarnação



CR B 01

	AWG		€		
0.50-6.00 mm ²	20-10	220 mm	27,62	60	CR B 01

Alicates de cravar, com operação de corte e descarnação



CR B 02

	AWG		€		
1.50-6.00 mm ²	14-10	220 mm	26,57	60	CR B 02

Alicates de cravar, com operação de corte e descarnação



CR B 03

	AWG		€		
1.50-6.00 mm ²	14-10	220 mm	27,04	60	CR B 03

Alicate para conexões de cabos redondos



CR B 05

	AWG		€		
0.5-2.5 mm ²	20-14	140 mm	53,76	2	CR B 05

Alicate de catraca para conectores isolados



CR W 01

	AWG		€		
0.5-6.0 mm ²	20-10	225 mm	155,55	1	CR W 01

Alicate para conexões de cabos redondos



CR B 06

	AWG		€		
0.5-16 mm ²	20-6	220 mm	107,50	2	CR B 06

Alicate de catraca para conectores não isolados



CR W 02

	AWG		€		
20-10 mm ²	20-10	225 mm	129,86	1	CR W 02

Alicate de cravar com roquete para conectores isolados - Perfil oval



CR OV 01

	AWG		€		
0.5-6.0 mm ²	20-10	256 mm	157,47	1	CR OV 01

Alicate de catraca para conectores do tipo aberto



CR W 03

	AWG		€		
0.5-6.0 mm ²	20-10	225 mm	129,86	1	CR W 03



Alicate de catraca para cravar conexões de alta qualidade



CR W 04

		€		
RG 58-59-62 mm ²	225 mm	135,78	1	CR W 04

Alicate de cravar auto-ajustável - Perfil quadrado



CR SA S01

	AWG		€		
0.14-10 mm ²	26-8	176 mm	212,58	1	CR SA S01

Alicate de catraca para conectores tubulares



CR W 05

AWG		€		
0.5-4.0	225 mm	137,88	1	CR W 05

Alicate de cravar auto-ajustável - Perfil hexagonal



CR SA H01

	AWG		€		
0.14-10 mm ²	26-8	176 mm	219,33	1	CR SA H01
0.14-16 mm ²	26-6	176 mm	240,45	1	CR SA H16

Alicate de catraca para conectores tubulares



CR W 06

AWG		€		
6-16	225 mm	145,73	1	CR W 06

Alicate de cravar auto-ajustável - Perfil trapezoidal



CR SA T01

	AWG		€		
0.14-10 mm ²	26-8	180 mm	208,08	1	CR SA T01

Alicate de cravar para conectores não isolados, para trabalho pesado



CR L 01

			€		
10-120 mm ²	10-95 mm ²	600 mm	398,68	1	CR L 01

Alicate de cravar para conectores não isolados, para trabalho pesado



CR L 02

		€		
6-50 mm ²	360 mm	294,47	1	CR L 02

Alicate de cravar para conectores não isolados, para trabalho pesado



CR L 03

		€		
25-150 mm ²	650 mm	448,52	1	CR L 03

CONJUNTOS DE ALICATES

Conjunto de alicates de precisão



9733

		€		
30 x 215 x 215 mm	8	386,68	1	9733

4130, 4131	
4239	
4830	
4530	
4231	
4430	
4833	

Conjunto de alicates de precisão



C3901/3

	€		
3	123,40	1	C3901/3

C3140IP	
C3640IP	
C3830IP	



Conjunto de alicates de precisão



C3902/3

	€		
3	113,00	1	C3902/3

C3330R	
C3840	
C3745	

Conjunto de chaves de parafusos e alicates compactos 8 peças



C3903/2-6

	€		
8	113,62	1	C3903/2-6

C3330R	
C3840	
700-1.5-50, 700-2-50, 700-2.5-50, 700-3-50	
701-0-50, 701-1-75	

Embalagem dupla 9031-8224



9031-8224

		€		
2	693 g	86,43	3	9031-8224

BAHCO

9031

8224



Conjunto de Chave ajustável e Alicata bomba água



9873

		€		
25 x 190 x 280 mm	2	54,35	1	9873

9072 P

8224



Conjunto Alicata e alicata bomba água, chave ajustável



9853

		€		
25 x 252 x 292 mm	3	80,54	1	9853

9071

2101G-160

8224



Conjunto de alicates



ergo®



9897

		€		
4	1030 g	136,33	1	9897

8224		
2628 G-180		
2101G-160		
2430 G-160		

Conjunto de alicates ERGO™ - 3 Pcs



ergo®



9897G/3

			€		
3	50 x 180 x 400 mm	788 g	81,99	1	9897G/3

2628 G-180	
2101G-160	
2430 G-200	

ALICATES DE PRENSÃO

Alicate de pressão. Com corte



2951

		€		
1.2 mm	140 mm	18,13	1	2951-140
2 mm	190 mm	24,78	1	2951-180
3 mm	235 mm	28,54	1	2951-250

		€		
4 mm	300 mm	48,04	1	2951-300

Com corte

Alicate de Pressão, com maxilas curvas sem corte



2953

	€		
140 mm	16,93	1	2953-140
190 mm	22,51	1	2953-200
235 mm	25,69	1	2953-250
300 mm	44,40	1	2953-300

Alicate de pressão. Com maxilas paralelas



2958

	€		
135 mm	17,97	1	2958-140
190 mm	24,78	1	2958-200
235 mm	28,54	1	2958-250

Com maxilas paralelas

Alicate de pressão. De múltipla abertura



2968

	€		
205 mm	24,78	1	2968-190
235 mm	28,54	1	2968-235

De múltipla abertura



Alicate de pressão Soldadura. Multifunções



2957

	€		
250 mm	27,03	1	2957-250

Multifunções

Alicate de pressão. De ponta longa



2952

	€		
155 mm	21,58	1	2952-165
230 mm	30,82	1	2952-235

De ponta longa

Alicate de pressão. Para chapa



2967

	€		
180 mm	39,27	1	2967-180

Para chapa

Alicate de pressão. Ponta Paralela



2955

	€		
235 mm	32,47	1	2955-250

Ponta Paralela

Alicate de pressão com corrente. 2999-SH: corrente suplente



2999

	€		
230 mm	48,62	1	2999-250
500 mm	14,31	1	2999-SHN

2999-SH: corrente suplente

Alicate de pressão para tubos com corrente. 2998-SH: corrente suplente



2998

	€		
240 mm	91,97	1	2998-250
330 mm	53,65	1	2998-SHN

2998-SH: corrente suplente

Grampo de fixação para bancada



2960

	€		
280 mm	54,25	1	2960-280

Alicate de Pressão, com maxilas paralelas



2950

	€		
235 mm	33,98	1	2950-250

Alicate de pressão. Com grampo em C



2963

	€		
283 mm	37,91	1	2963-280
458 mm	62,22	1	2963-450
580 mm	74,83	1	2963-630

Com grampo em C

Alicate de pressão de aço, blocos giratórios, fino



2956

	€		
282 mm	44,71	1	2956-290

Alicate de pressão. Com grampo em C paralelo



2964

	€		
175 mm	31,26	1	2964-160
280 mm	41,22	1	2964-280
436 mm	69,61	1	2964-450
625 mm	81,53	1	2964-600

Com grampo em C paralelo

Alicate de pressão tipo C



2962

	€		
290 mm	56,87	1	2962-8-150
290 mm	73,09	1	2962-8-230
290 mm	79,28	1	2962-8-300



Alicate de pressão "U". Para soldadura



2965

↔ L ↔	€		
228 mm	32,62	1	2965-200
290 mm	43,20	1	2965-280

Para soldadura

Alicate de pressão com 4 posições, ponta longa



2997

↔ L ↔	€		
255 mm	74,89	5	2997-300

Alicate de pressão. Para tubos



2966

↔ L ↔	€		
290 mm	44,24	1	2966-280

Para tubos

Alicate de pressão com 4 posições, boca curta



2997-250

↔ L ↔	€		
235 mm	67,97	1	2997-250

Peças sobresselentes para alicate de pressão



2951-S

	↔ L ↔		€		
	43 mm	15 g	3,62	1	2951-S05
	46 mm	25 g	3,62	1	2951-S07
	62 mm	50 g	3,62	1	2951-S10
	87 mm	70 g	3,62	1	2951-S12

Tenazes de ajuste rápido com fuso



2949

↔ L ↔	€		
193 mm	62,31	1	2949-190IP
196 mm	66,10	1	2949-200IP
240 mm	69,28	1	2949-240IP
240 mm	86,07	1	2949-250IP

Parafuso sobresselente para torno manual



2949-L

	L	€		
2949-190IP	75 mm	5,72	1	2949-L075
2949-200IP, 2949-240IP	120 mm	5,96	1	2949-L120
2949-250IP	200 mm	7,33	1	2949-L200

FERRAMENTAS PARA REBITAR

Alicate de rebitar



2681

L	€		
285 mm	40,48	12	2681

Rebitador Manual. Capacidade 2.4 - 5 mm



1467-250

L	€		
255 mm	61,59	1	1467-250

Capacidade 2.4 - 5 mm

Alicate de entalhe



2690

L	€		
200 mm	58,30	10	2690

Rebitador Manual Longo. Capacidade: 3 - 6.40 mm



1467-520

L	€		
530 mm	199,94	1	1467-520

Capacidade: 3 - 6.40 mm

Rebitador Extensível



1467-320-850

L	€		
850 mm	258,79	1	1467-320-850



PEÇAS DE SUBSTITUIÇÃO PARA REBITADORES 1467



1467

g	€		
10 g	19,17	1	1467-LJ
10 g	15,56	1	1467-SJ

CONJUNTO DE PEÇAS DE SUBSTITUIÇÃO PARA 2681



2681-1

g	€		
15 g	3,46	1	2681-1

ALICATES ESPECIAIS

Ferramenta para tensão de abraçadeira de fivela



790450A

∅	€		
<2.2x5 mm	65,98	1	790450A

Ferramenta para tensão de abraçadeira de fivela



790455A

∅	€		
<9.5x2.3 mm	56,03	1	790455A

Alicate torcedor



2855

L	€		
236 mm	154,37	1	2855
287 mm	195,42	1	2855 D

Alicate de torção de fio, operação com uma mão



2856

L	€		
203 mm	314,51	1	2856-8
268 mm	314,51	1	2856-10



Chaves de bocas para tubos e ferramentas para tubagens



CHAVES DE BOCAS PARA TUBOS

Chave de tubos de ajuste rápido



ergo®



1610/1620

L	max	€		
320 mm	1 in	78,70	1	1610
430 mm	1 1/2 in	107,06	1	1620

A porca de ajuste rápido é 10 vezes mais rápida que a chave de tubos standard, permitindo um ajuste mais rápida e poupança de tempo

Chave para tubo



ergo®



1410/1420

L	max	€		
320 mm	1 in	77,09	1	1410
430 mm	1 1/2 in	103,72	1	1420

Chave de cano de 90° ERGO™ modelo suco com haste suave ao toque



ergo®



1410D/1420D

L	max	€		
320 mm	1 in	85,88	1	1410D
430 mm	1 1/2 in	115,50	1	1420D

Chave para tubo universal



140-147

L	max	€		
210 mm	3/4 in	54,84	1	140
320 mm	1 in	61,68	1	141
426 mm	1 1/2 in	82,96	1	142
557 mm	2 1/2 in	135,48	1	143
722 mm	3 1/2 in	225,71	1	144
1060 mm	5 in	434,96	1	147

Porca de substituição para chaves de tubos de ajuste rápido



1610-nut/1620-nut

Ø	g	€		
11 mm	34 g	12,49	1	1610-NUT
11.5 mm	48 g	14,61	1	1620-NUT

Chave para tubo universal - Aço vanadium-extra



DOW175

L	max	€		
310 mm	1 in	39,56	1	DOW 175-1
420 mm	1 1/2 in	54,29	1	DOW 175-11/2
560 mm	2 in	85,12	1	DOW 175-2
630 mm	3 in	141,82	1	DOW 175-3

Chave para tubo de cantos



442 B-444 B

L	max	€		
320 mm	1 in	67,87	1	442 B
430 mm	2 in	80,23	1	443 B
545 mm	2 1/2 in	107,96	1	444 B

Chave para tubo 45° modelo combinado



341-344

L	max	€		
230 mm	1/2 in	52,86	1	341
330 mm	1 in	59,48	1	342
420 mm	1 1/2 in	80,00	1	343
530 mm	2 in	119,73	1	344

Chave para tubo modelo combinado. Aço vanadium-extra



DOW177

L	max	€		
325 mm	1 in	49,10	1	DOW 177-1/2-1
425 mm	1 1/2 in	62,39	1	DOW 177-11/2
534 mm	2 in	93,22	1	DOW 177-2

Aço vanadium-extra

Chave para tubo de cantos 45° - Aço vanadium-extra



DOW176

L	max	€	Icon 1	Icon 2
330 mm	1 in	51,47	1	DOW 176-1
415 mm	1 1/2 in	66,16	1	DOW 176-11/2
530 mm	2 in	91,07	1	DOW 176-2

Maxila de substituição fixa para chaves de tubos de alumínio



8100F

L	g	€	Icon 1	Icon 2
380-18	90 g	17,84	1	8100F0180
380-24	180 g	20,75	1	8100F0240

Maxila de substituição para chaves Stillson



8060B

L	g	€	Icon 1	Icon 2
361-8	80 g	13,05	1	8060B0080
361-10	200 g	18,12	1	8060B0100
361-12	270 g	20,01	1	8060B0120
361-14	330 g	20,15	1	8060B0140
361-18	520 g	28,42	1	8060B0180
361-24	970 g	48,42	1	8060B0240
361-36	1630 g	71,05	1	8060B0360

Chave Tubos em Alumínio



380

L	max	€	Icon 1	Icon 2
253 mm	1.1/2 in	45,14	1	380-10
320 mm	2 in	60,00	1	380-14
455 mm	2.1/2 in	85,71	1	380-18
607 mm	3 in	142,80	1	380-24
910 mm	4 in	276,19	1	380-36
1210 mm	6 in	406,67	1	380-48

Porca de substituição para chaves de tubos de alumínio



8100T

L	g	€	Icon 1	Icon 2
380-10	30 g	6,56	1	8100T0100
380-14	45 g	7,84	1	8100T0140
380-18	70 g	10,53	1	8100T0180
380-24	110 g	14,67	1	8100T0240
380-36	220 g	25,98	1	8100T0360
380-48	310 g	17,13	1	8100T0480

Porca de substituição para chaves Stillson



8060T

L	g	€	Icon 1	Icon 2
361-8	20 g	9,80	1	8060T0080
361-10	20 g	9,21	1	8060T0100
361-14	40 g	9,50	1	8060T0140
361-18	70 g	9,94	1	8060T0180
361-24	90 g	15,81	1	8060T0240
361-36	250 g	24,50	1	8060T0360

Maxila de substituição para chaves de tubos de alumínio



8100B

L	g	€	Icon 1	Icon 2
380-14	430 g	30,74	1	8100B0140
380-18	680 g	40,80	1	8100B0180
380-24	1000 g	54,23	1	8100B0240
380-36	1810 g	100,78	1	8100B0360

Chave Stillson para tubos



361

L	max	€	Icon 1	Icon 2
185 mm	1 in	29,83	1	361-8
230 mm	1.1/2 in	33,17	1	361-10
265 mm	1.3/4 in	38,69	1	361-12
315 mm	2 in	41,48	1	361-14
450 mm	2.1/2 in	58,04	1	361-18
535 mm	3 in	96,46	1	361-24
900 mm	4 in	185,69	4	361-36

Chave corrente metal para tubos



372

L	€	Icon 1	Icon 2
1.1 in	113,33	1	372-1.1/2
2.1 in	209,68	1	372-2.1/2
4 in	267,31	1	372-4
6 in	459,27	1	372-6
8 in	621,59	1	372-8
12 in	1.069,31	1	372-12



Corrente de Substituição para chaves de tubos.



3074

L		€		
340 mm	372-1.1/2	34,16	1	307401B
475 mm	372-2.1/2	51,07	1	307411B
560 mm	372-4	82,35	1	307421B
830 mm	372-6	136,83	1	307431B
1000 mm	372-8	186,59	1	307441
1400 mm	372-12	273,66	1	307451

Chave lavatorio



363

L	€		
280 mm	47,03	1	363-32

CORTADOR DE TUBOS DE 35 MM
BETTER



402-35

Ø	€		
3-35 mm	55,83	6	402-35

FERRAMENTAS PARA CORTE DE TUBOS

Chave para tubos com corrente



370

L	€		
300 mm	47,03	1	370-4

CORTADOR DE TUBOS DE 16 MM
BETTER



401-16

Ø	€		
3-16 mm	31,08	12	401-16

CORTADOR DE TUBOS DE 76 MM
BETTER



402-76

Ø	€		
12-76 mm	114,20	6	402-76

Chave para tubos con fita plástico



375

L	€		
300 mm	47,03	50	375-8

CORTADOR DE TUBOS DE 28 MM
BETTER



401-28

Ø	€		
3-28 mm	31,08	12	401-28

Corta tubo automático



306-

Ø	€		
10 mm	31,36	1	306-10
12 mm	33,14	1	306-12
15 mm	34,89	12	306-15
22 mm	38,37	12	306-22

Alicate compacto de corte para tubos 3-16 mm



301-16

		€		
3-16 mm	72 mm	27,36	12	301-16

Corta Tubos. roda suplente 302-76-95



302-76

	€		
	6,12	1	302-76-95

roda suplente 302-76-95

Conjunto de rodas sobresselentes e pino para alicates de corte para tubos 301/302



302-95-SET

	€		
30 g	24,87	1	302-95-SET

Corta Tubos. roda suplente 301-22-95



301-22

	€		
3-28 mm	26,12	12	301-22

roda suplente 301-22-95

Alicate de corte para tubos com sistema de ajuste rápido 12-76 mm



302-76N

		€		
12-76 mm	318 mm	94,54	6	302-76N

Disco de corte de substituição



306-15-95

	€		
10 g	12,06	1	306-15-95

Corta Tubos. 302-35-95: roda suplente



302-35

	€		
3-35 mm	41,52	6	302-35

=D1608

Rodas de corte sobresselentes para cortadores de tubos das séries 301/302 e 401/402



302/402-15-95

		€		
301-16,301-22, 302-35,302-75N	5 g	6,36	100	302-15-95
401-16,401-28, 402-35,402-75	5 g	9,45	1	402-15-95

DISCOS/PINO PARA CONJUNTO 401/402



402-95-SET

	€		
30 g	36,79	1	402-95-SET



Corta Tubos



311-32

	€		
32 mm	21,63	6	311-32

Tesoura de tubos para múltiplas camadas



412-26-MULTI

	€		
26 mm	85,57	5	412-26-MULTI

Lâminas de substituição para 412-26-MULTI



412-26-MULTI-95

		€		
1	10 g	20,32	150	412-26-MULTI-95

Tesoura para tubos de plástico



411

	€		
26 mm	45,63	4	411-26
35 mm	59,69	4	411-35
42 mm	78,27	6	411-42
63 mm	115,15	5	411-63

Lâminas de substituição para tesouras de plástico



411-95

		€		
1	39 g	16,94	50	411-26-95
1	37 g	26,56	50	411-35-95
1	41 g	31,40	50	411-42-95
1	48 g	59,39	30	411-63-95

FERRAMENTAS PARA DOBRAR E MOLDAR

Curva tubos



1084

			€		
250 mm	6,8	10 mm	87,04	5	1084

Tesoura de tubos para PEX



412-28-PEX

	€		
28 mm	58,51	5	412-28-PEX

Lâminas de substituição para 412-28-PEX



412-28-PEX-95

		€		
1	35 g	20,22	30	412-28-PEX-95

Alicate para dobrar tubos



500

	€		
12 mm	120,53	1	500-12
14 mm	129,22	1	500-14
15 mm	133,23	1	500-15
16 mm	139,57	1	500-16
18 mm	164,33	1	500-18
22 mm	188,31	1	500-22

Tubo de dilatação em métrica



4480MM

		€		
45°	4, 6, 8, 10, 12, 14, 16, 18 mm	59,70	1	4480MM

Tubo de dilatação em polegadas



4480IM

		€		
45°	5/8, 3/16, 1/4, 5/16, 3/8, 7/16, 1/2, 3/4 in	59,70	1	4480IM

Jogo de abocardador e corta tubos. Adaptador de dilatação duplo: 3/16", 1/4", 5/16", 3/8" e 1/2"



4480/

	€		
45 x 140 x 330 mm	155,68	1	4480/2-ZD

Adaptador de dilatação duplo: 3/16", 1/4", 5/16", 3/8" e 1/2"

FERRAMENTAS PARA REBARBAR

Caneta corte rebarbas



316-1

	€		
143 mm	13,38	12	316-1

Caneta corte rebarbas. Lâmina sobresselente 316-2-95



316-2

	€		
150 mm	20,05	12	316-2

Lâmina sobresselente 316-2-95

Caneta corte rebarbas: lâmina substituição



316-2-95

	€		
3 g	10,56	1	316-2-95

Roda corta rebarbas



318-38/318-54

	€		
8-38 mm	84,17	1	318-38
10-54 mm	134,86	1	318-54

Roda corta rebarbas



317-40

	€		
3-40 mm	13,48	12	317-40





BAHCO



Ferramentas pneumáticas



PISTOLAS DE IMPACTO

Mini-pistolas de impacto de cabeça quadrada de 3/8"



BP704

BAR €
 6.3 bar 1500 min **212,33** 1 BP704

Pistola de impacto de compósito de 3/8"



BPC816

BAR €
 12.000 min 6,3 bar **301,40** 10 BPC816

Pistola de impacto angular de encaixe quadrado de 1/2"



BP814A

BAR €
 7000 min 6.2 bar **496,77** 10 BP814A

Pistola de impacto 1/2"



BP814

BAR €
 10,000 min 6.3 bar **254,92** 10 BP814

Pistola Impacto Pneumática 1/2"



BP815

BAR €
 7,000 min 6.3 bar **254,92** 1 BP815

Jogo Pistola Impacto 1/2". Contém: Chave de impacto 1/2", 11 chaves de caixa (10-24 mm) e um conector macho 1/4"



BP815K1

BAR €
 7,000 min 6.3 bar **372,58** 1 BP815K1

Contém: Chave de impacto 1/2", 11 chaves de caixa (10-24 mm) e um conector macho 1/4"

BP815

K7800M-10, K7800M-11, K7800M-12, K7800M-13, K7800M-14, K7800M-15, K7800M-17, K7800M-19, K7800M-22, K7800M-24, K7800M-21

PM5142

Jogo Pistola de Impacto 1/2". Contém: Chave de impacto 1/2", suporte magnético e 3 chaves de caixa para roda (17,19,21mm numa caixa)



BP815K2

BAR €
 7,000 min 6.3 bar **320,29** 1 BP815K2

Contém: Chave de impacto 1/2", suporte magnético e 3 chaves de caixa para roda (17,19,21mm numa caixa)

Micro-pistola de impacto de 1/2"



BPC813

BAR €
 10000 min 6,3 bar **254,92** 10 BPC813

Conj. micro-pistolas impacto 1/2" c/chaves impacto curtas



BPC813K1

1/2 in 65 x 162 x 215 mm **344,15** 1 BPC813K1

BPC813

K7800M-13, K7800M-14, K7800M-16, K7800M-17, K7800M-19, K7800M-21, K7800M-22, K7800M-24

Pistola de impacto de compósito de 1/2"



BPC814

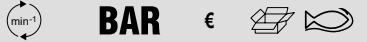

12000 min⁻¹ **BAR** € 294,15 10 BPC814

Pistola de impacto de compósito de 1/2"



BPC815

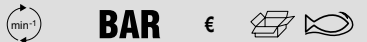

8000 min⁻¹ **BAR** € 307,21 1 BPC815

CONJUNTO DE PISTOLA DE IMPACTO, 1/2"



BPC815K1

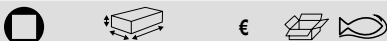

1/2 in 90 x 230 x 390 mm **592,19** 1 BPC815K1

BPC815

K7801M-10, K7801M-11, K7801M-12, K7801M-13, K7801M-14, K7801M-15, K7801M-17, K7801M-19, K7801M-21, K7801M-22, K7801M-24

CONJUNTO DE PISTOLA DE IMPACTO, 1/2"



BPC815K2

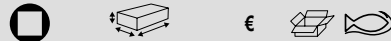

1/2 in 90 x 230 x 320 mm **507,40** 1 BPC815K2

BPC815

K7801M-19, K7801M-22, K7801M-24, K7801M-17, K7801M-13

CONJUNTO DE PISTOLA DE IMPACTO, 1/2"



BPC815K3

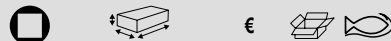

1/2 in 90 x 230 x 320 mm **523,78** 1 BPC815K3

BPC815

K7801Z-1/2, K7801Z-5/8, K7801Z-3/4, K7801Z-7/8, K7801Z-15/16

CONJUNTO DE PISTOLA DE IMPACTO, 1/2"



BPC815K4



1/2 in 90 x 230 x 320 mm **548,31** 1 BPC815K4

BPC815

BWSS12P5

CONJUNTO DE PISTOLA DE IMPACTO, 1/2"



BPC815K6

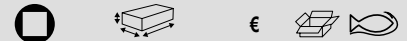

1/2 in 90 x 230 x 320 mm **483,01** 1 BPC815K6

BPC815

BWSS12P319, BWSS12P317

Pistola Impacto Pneumática 3/4"



BP817



4,500 min⁻¹ **BAR** € 620,95 1 BP817

Pistola de impacto de compósito de 3/4"



BPC817



5000 min⁻¹ **BAR** € 699,40 4 BPC817



CONJUNTO DE PISTOLA DE IMPACTO,
3/4"



BPC817K1

3/4 in 105 x 295 x 390 mm **1.037,16** 1 BPC817K1

BPC817

K8901M-24, K8901M-27, K8901M-32,
K8901M-30

CONJUNTO DE PISTOLA DE IMPACTO,
3/4"



BPC817K2

3/4 in 105 x 295 x 390 mm **1.019,36** 1 BPC817K2

BPC817

K8901Z-15/16, K8901Z-1,
K8901Z-1.1/16, K8901Z-1.1/8

Pistola Impacto Pneumática 1"



BP901

BAR € 3800 min 6.2 bar **986,99** 1 BP901

Pistola Impacto Pneumática 1" Eixo Longo



BP901L

BAR € 3800 min 6.2 bar **1.000,05** 1 BP901L

CHAVE DE IMPACTO LEVE DE 1" TIPO
PISTOLA



BP905P

BAR € 6000 min 6.2 bar **1.300,73** 2 BP905P

PISTOLA DE IMPACTO DE 1", BATENTE
LEVE, RETO E CURTO



BP905S

BAR € 6000 min 6.2 bar **1.292,89** 2 BP905S

PISTOLA DE IMPACTO DE 1", BATENTE
LEVE, RETO E LONGO



BP905L

BAR € 6000 min 6.2 bar **1.305,95** 2 BP905L

Bolsa para pistola de impacto. BPMBL
passend zu BPM915



BPM91B

85 x 80 x 180 mm 162 g **15,32** 1 BPM91B

BPMBL passend zu BPM915

Kit de pistola de impacto de silenciador.
BPM91MK1 passend zu BPM914 und
BPM916



BPM91MK

30 x 25 x 25 mm 5 g **5,81** 1 BPM91MK1
30 x 25 x 50 mm 10 g **5,81** 1 BPM91MK2

BPM91MK1 passend zu BPM914 und BPM916

ROQUETES

Roquete Pneumático 1/4"



BP700

	BAR	€		
300 min	6.3 bar	204,10	20	BP700

Roquetes pneumáticos com cabeça quadrada de 3/8"



BP721

	BAR	€		
350 min	6.3 bar	182,18	1	BP721

Roquete Pneumático 3/8"



BP820

	BAR	€		
270 min	6.3 bar	217,66	1	BP820

Roquete Pneumático 1/2"



BP821

	BAR	€		
150 min	6.3 bar	255,28	1	BP821

Roquete de impacto sem retorno com cabeça quadrada de 1/2"



BPR821

	BAR	€		
600 min	6.3 bar	263,84	1	BPR821

Bolsa para roquete pneumático. BP91BL zur Verwendung mit BP921



BP91B

		€		
35 x 40 x 60 mm	12 g	3,02	1	BP91BL
30 x 30 x 45 mm	6 g	3,02	1	BP91BS

BP91BL zur Verwendung mit BP921

REBARBADORAS, LIXADEIRAS E POLIDORES

Rectificadora Pneumática Angular 6mm



BP115

	BAR	€		
20,000 min	6.3 bar	202,66	1	BP115

Rectificadora



BP117

	BAR	€		
2500 min	6.3 bar	262,71	1	BP117

Rectificadora de baixas rotações com bucha de aperto de chave



BP118

	BAR	€		
2500 min	6.3 bar	239,07	1	BP118



Rectificadora 6mm. *inclui coletor 3mm



BP822

	BAR	€		
25,000 min	6.3 bar	165,49	1	BP822

*inclui coletor 3mm

Rectificadora 6mm. *inclui coletor 3mm



BP822E

	BAR	€		
25000 min	6.3 bar	202,66	10	BP822E

*inclui coletor 3mm

Abrasivo 6 mm. *2 unidades numa embalagem



BP421M

		€		
53 mm	14 mm	4,56	1	BP421M

*2 unidades numa embalagem

Abrasivo 6 mm. *2 numa embalagem



BP422M

		€		
46 mm	26 mm	4,56	1	BP422M

*2 in a blister

Abrasivo 6 mm. *2 numa embalagem



BP424M

		€		
57 mm	19 mm	4,56	1	BP424M

=D1705

Abrasivo 3 mm. *2 numa embalagem



BP430M

		€		
55 mm	12 mm	4,56	1	BP430M

*2 numa embalagem

Abrasivo 6 mm. *2 unidades numa embalagem



BP420M

		€		
67 mm	25 mm	4,56	1	BP420M

*2 unidades numa embalagem

Abrasivo 6 mm. *2 numa embalagem



BP423M

		€		
53 mm	25 mm	4,56	1	BP423M

*2 numa embalagem

Abrasivo 3 mm. *2 numa embalagem



BP431M

		€		
54 mm	13 mm	4,56	1	BP431M

*2 numa embalagem

Abrasivo 3 mm. *2 numa embalagem



BP432M

		€		
44 mm	15 mm	4,56	1	BP432M

*2 numa embalagem

Rebarbadora Pneumática 3" / 75mm



BP110

	BAR	€		
18,000 min	6.3 bar	221,76	1	BP110

Mangueira para rectificadora



BP117EH

		€		
50 x 100 x 50 mm	1 kg	45,25	1	BP117EH

Abrasivo 3 mm. *2 numa embalagem



BP433M

		€		
43 mm	14 mm	4,56	1	BP433M

*2 numa embalagem

Lixadeira Pneumática Angular 5"



BP823

	BAR	€		
10,000 min	6.3 bar	420,31	1	BP823

Pistola de Agulhas Pneumática. 19 agulhas 3x180mm



BP127

	BAR	€		
3700 min	6.3 bar	394,04	1	BP127

19 agulhas 3x180mm

Abrasivo 3 mm. *2 numa embalagem



BP434M

		€		
45 mm	13 mm	4,56	1	BP434M

*2 numa embalagem

Ferramenta de corte comprida 4"/102mm



BP111E

	BAR	€		
15000 min	6.3 bar	309,35	12	BP111E

Aparelhos de limpeza de superfícies com pega tipo pistola com 19 agulhas



BP127P

	BAR	€		
3800 min	6.3 bar	271,38	1	BP127P



Conjunto de agulhas



BP12718

		€		
BP127, BP127P	3 mm	22,53	1	BP12718

Prato de borracha à base de solvente



BP830ESB

		€		
30 mm	105 mm	27,24	1	BP830ESB

Adaptador para cerdas retas



BP830SBA

		€		
BP830K	105 mm	23,87	1	BP830SBA

Cerdas de aço inclinadas grosseiras



BP830CISB

		€		
BP830K	105 mm	36,70	1	BP830CISB

Borracha à base de água



BP830EWB

		€		
BP830K	105 mm	27,24	1	BP830EWB

Cerdas de aço retas



BP830SSB

		€		
BP830K	105 mm	36,70	1	BP830SSB

Kit de lixa pneumática



BP830K

	BAR	€		
4000 min ⁻¹	6.3 bar	521,40	4	BP830K

Cerdas de aço retas

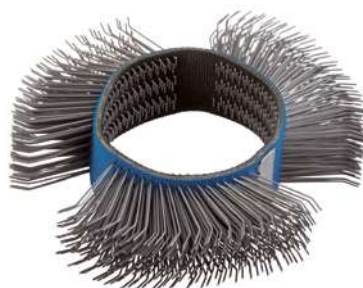

BP830MISB

		€		
BP830K	105 mm	36,70	1	BP830MISB

Disco de decapagem



BP830SW

		€		
BP830K	105 mm	27,24	1	BP830SW

Conjunto Lixadeira Orbital Pistola



BP204K

	BAR	€		
15000 min	6.3 bar	487,88	1	BP204K

BP20425180, BP20410800, BP20410320, BP20425220

BP204

Bloco de lixar



BP204PAD

		€		
77 mm	-	15,10	1	BP204PAD

Lixadeira de Fita Pneumática 10mm



BP212

	BAR	€		
16,000 min	6.3 bar	244,31	1	BP212

Disco para Lixadeira Orbital



BP51137

		€		
152 mm	x	40,70	1	BP51137

Lixadeira Orbital 5mm



BP601

	BAR	€		
152 mm	6.3 bar	394,04	1	BP601

DISCO COM VELCRO COM 53 FUIROS



BP60102

		€		
BP601	152 mm	55,98	1	BP60102

Lixadeira Orbital Pistola



BP204

	BAR	€		
15000 min	6.3 bar	270,19	1	BP204

Discos para lixadeira. em embalagens de 10 pcs ou 25 pcs



BP204xyyy

	€		
77 mm	17,25	1	BP20410320
77 mm	9,15	1	BP20410800
77 mm	34,50	1	BP20425180
77 mm	34,50	1	BP20425220

em embalagens de 10 pcs ou 25 pcs

Lixadeira de Fita Pneumática 20mm



BP222

	BAR	€		
16,000 min	6.3 bar	255,20	1	BP222



Lixadeira Orbital 2.5mm



BP610

	BAR	€		
152 mm	6.3 bar	394,04	1	BP610

Polidor Vertical de 7"



BP810

	BAR	€		
2500 min	6.3 bar	353,76	1	BP810

Brocas pneumáticas reversíveis de 1/2" e 800 rpm



BPC825

	BAR	€		
800 min	6.3 bar	183,43	1	BPC825

Embalagem de 25 Fitas para Lixadeira



BPN22201/21201

	€		
10 mm	141,86	1	BPN21201
20 mm	167,09	1	BPN22201

7" Wool bonnet



BP80950

		€		
178 mm	15 g	12,43	1	BP80950

Brocas pneumáticas reversíveis compactas de 3/8" e 2000 rpm



BPC823

	BAR	€		
2000 min	6.3 bar	157,04	1	BPC823

BROCAS E CHAVES DE PARAFUSOS

Polidor Angular de 7"



BP809

	BAR	€		
2500 min	6.3 bar	406,48	1	BP809

Berbequim Pneumático 13mm. *Mudança rápida de sistema de disco sem ferramentas



BP825

	BAR	€		
450 min	6.3 bar	359,70	1	BP825

*Mudança rápida de sistema de disco sem ferramentas

Brocas pneumáticas angulares compactas de 3/8" e 1400 rpm



BPA823

	BAR	€		
1400 min	6.3 bar	154,54	1	BPA823

Aparafusadora Pneumática 1800 RPM
1/4". Aperto regulável externo



BP826

	BAR	€		
1800 min	6.3 bar	364,77	1	BP826

Aperto regulável externo

Aparafusadora Pneumática 800 RPM 1/4".
Aperto regulável externo



BP827

	BAR	€		
800 min	6.3 bar	405,09	1	BP827

Aperto regulável externo

FERRAMENTAS DE CORTE

Serras vaivém compactas com gatilho de
segurança



BP828

	BAR	€		
10000 min	6.3 bar	276,40	1	BP828

Serra Pneumática



BP824

	BAR	€		
10,000 min	6.3 bar	336,69	1	BP824

Serras vaivém com mudanças e gatilho de
segurança



BPG824

	BAR	€		
7400 min	6.3 bar	314,10	10	BPG824

Descolador para Parabrisas



BP233

	BAR	€		
20	6.3 bar	362,53	1	BP233

Lâminas Planas. A: glatt, B: gezackt



BPBG

	€		
15 mm	34,68	1	BPBG3515
25 mm	34,68	1	BPBG3525A
25 mm	38,63	1	BPBG3525B

A: glatt, B: gezackt

Lâminas em "virgula". *2 numa
embalagem



BPBK

	€		
30 mm	34,68	1	BPBK30

*2 numa embalagem

Lâminas Raspar. *2 unidades numa
embalagem



BPBSC

	€		
15 mm	51,04	1	BPBSC156

*2 unidades numa embalagem



Lâminas em "U". *2 numa embalagem



BPBU

L	€		
18 mm	56,74	1	BPBU18
24 mm	56,74	1	BPBU24
36 mm	64,63	1	BPBU36
60 mm	69,36	1	BPBU60
90 mm	84,32	1	BPBU90

*2 numa embalagem

Tesoura para corte de chapa. Capacidade de corte 1.6 mm Alumínio/1.2 mm aço



BP811

min ⁻¹	BAR	€		
2,600	6.3 bar	136,99	1	BP811

Capacidade de corte 1.6 mm Alumínio/1.2 mm aço

Lâminas offset 13mm. *2 numa embalagem



BPBG5725/9057

L	€		
57 mm	34,68	1	BPBG5725
90 mm	84,32	1	BPBG9057

*2 numa embalagem

MARTELOS, REBITADORES E MARCADORES

Martelos pneumáticos 3200 bpm



BP910

BAR	rpm (min ⁻¹)	€		
6.3 bar	3200	182,18	5	BP910

Cinzel rotativo plano 10.2mm



BP909TF

L	€		
170 mm	29,31	1	BP909TF

Cinzel rotativo plano largo 10.2mm



BP909TWF

L	€		
170 mm	29,31	1	BP909TWF

Cinzel rotativo de ponta 10.2mm



BP909TTP

L	€		
165 mm	29,31	1	BP909TTP

Cinzel rotativo bico 10.2mm



BP909TE

L	€		
139 mm	37,56	1	BP909TE

Cinzel rotativo martelo 10.2mm



BP909TH

L	€		
108 mm	37,56	1	BP909TH

Cinzel rotativo martelo 10.2mm



BP909TSP

	€		
165 mm	29,31	1	BP909TSP

Cinzel plano 10.2mm



BP909NF

	€		
190.5 mm	79,64	1	BP909NF

Cinzel bico 10.2mm



BP909NE

	€		
173 mm	97,68	1	BP909NE

Rebitadores pneumáticos com 880 kg de força de tração



BP277K

	€		
6.3 bar	14	277,66	8 BP277K

Rebitadores pneumáticos com 1600 kg de força de tração



BP125A

	€		
6.3 bar	19	697,92	6 BP125A

Marcador Pneumático



BP799

	BAR	€		
13,000 min ⁻¹	6.3 bar	202,53	1	BP799

Ponta Substituição para Marcador Pneumático



BP79912

	€		
10 g	42,74	1	BP79912

Pistola para silicone. Aplicador para cartuchos de 310 ml



BP215A

BAR	€		
3.5-4.8 bar	65,80	10	BP215A

PISTOLAS DE PINTURA

Pistola de Pintura Pneumática HVLP



BPHVLP01

	BAR	€		
0.7 kg	2-2.8 bar	194,78	1	BPHVLP01



Conjunto de pontas para pistola de pintura pneumática. A ser usado com BPHVLP01



BPHVLP

Ø	€	📦	🐟
1.2 mm	22,86	1	BPHVLP0112
1.4 mm	22,86	1	BPHVLP0114
1.7 mm	22,86	1	BPHVLP0117
2.0 mm	22,86	1	BPHVLP0120

A ser usado com BPHVLP01

SOPRADORES E FERRAMENTAS DE LIMPEZA

Pistola de ar. Válvula de limitação de pressão



BP218

BAR	€	📦	🐟
6.3 bar	25,23	1	BP218

Válvula de limitação de pressão

Pistola de Ar



BP219

BAR	€	📦	🐟
6.3 bar	21,72	1	BP219

Pistola de Ar com bocal longo
Bocal com 330mm de comprimento.
Comprimento da válvula 330 mm



BP219L

BAR	€	📦	🐟
6.3 bar	25,25	1	BP219L

Comprimento da válvula 330 mm

Pistolas de ar com entrada em latão e bocal extra longo de 1 m



BP219XL

BAR	→ l/min →	€	📦	🐟
6.3 bar	100 l/min	22,55	10	BP219XL

PISTOLA DE SOPRO POR VÁCUO



BP219V

BAR	€	📦	🐟
6.3 bar	71,90	1	BP219V

Pistola de limpeza



BPN010

BAR	min ⁻¹	€	📦	🐟
6.2 bar	6000-7500 min	201,92	1	BPN010

ACESSÓRIOS E EQUIPAMENTOS PARA FERRAMENTAS PNEUMÁTICAS

Suporte Magnético para Pistolas Impacto. Contém uma chave de impacto, quatro chaves de caixas e uma chave de torque



BP500

kg	€	📦	🐟
0.380 kg	55,44	1	BP500

Contém uma chave de impacto, quatro chaves de caixas e uma chave de torque

Filtro Regulador Linhas Pneumáticas 1/2". 200 cc Kapazität, Arbeitstemperatur -5° bis 60°C



BP254

→ l/min →	BAR	€	📦	🐟
max 3800 L/min l/min	1-8.5 bar	142,56	1	BP254

200 cc Kapazität, Arbeitstemperatur -5° bis 60°C

Filtro Regulador + Lubrificador para Linhas Pneumáticas 1/2". 200cc Kapazität, Arbeitstemperatur -5° bis 60°C



BP255

	BAR	€		
max 3,800 l/min	1-8.5 bar	213,83	1	BP255

200cc Kapazität, Arbeitstemperatur -5° bis 60°C

Lubrificador para linhas pneumáticas 1/4"



BPN251

		€		
1/4" in	0.100 kg	16,08	1	BPN251

Regulador de filtro de 1/2" e unidades lubrificadoras com saída de ar seco limpo de tipo T



BP255T

	BAR	€		
max 3800 l/min	1-8.5 bar	267,61	1	BP255T

Saída de ar seco limpo adicional para o regulador do filtro de 1/2" e unidades lubrificadoras com saída de ar seco limpo de tipo T



BP255T-1

	BAR	€		
max 3800 l/min	1-8.5 bar	42,72	1	BP255T-1

Mangueira Pneumática em Espiral Flexível 13mm



BPH1310

		€		
1/2"-1/2" in	10 m	85,63	1	BPH1310A

Mangueira Pneumática em Espiral Flexível 10mm



BPH1010

		€		
1/4"-1/4" NPT in	10 m	47,27	1	BPH1010A
1/4"-1/4" BSP in	10 m	38,37	1	BPH1010B

Adaptador de controlo de velocidade para enrolador de mangueira pneumática flexível



BPHRSC

	€		
76 x 88 x 114 mm	94,79	1	BPHRSC

Enrolador de mangueira de ar



BPHRC815/1015

		€		
8 mm	15 m	260,14	1	BPHRC815
10 mm	14+1 m	287,59	1	BPHRC1015

Enroladores de mangueira de ar



BPHRC1020/1316

		€		
10 mm	20 m	390,88	1	BPHRC1020
13 mm	15+1 m	424,87	1	BPHRC1316



Enrolador de mangueira de ar



BPHRO1315

		€		
13 mm	13+2 mm	575,20	1	BPHRO1315

Conectores pneumáticos rotativos de 1/4"



BPSJ

	€		
1/4" in	30,15	1	BPSJ

Conectores pneumáticos rotativos de 1/4" com sistema de bloqueio da rotação



BPSJL

	€		
1/4" in	35,18	1	BPSJL





Ferramentas elétricas sem fios



PISTOLAS DE IMPACTO

12V Pistola de Impacto 1/4"



BCL31IW1

V € 1 BCL31IW1
12V 1/4" 192,25

12V Kit Aparafusadora de Impacto 1/4"



BCL31IW1K1

€ 1 BCL31IW1K1
110 x 310 x 390 mm 3.1 kg 332,46

BCL31B1x 2
BCL31C1
BCL31IW1



14,4V Pistola de Impacto 3/8"



BCL32IW1

V € 1 BCL32IW1
14.4V 3/8" 339,95

14,4V Kit Pistola de Impacto 3/8"



BCL32IW1K1

€ 1 BCL32IW1K1
110 x 310 x 390 mm 3.6 kg 490,12

BCL32IW1
BCL32B1x 2
BCL31C1



18V Kit Pistola de Impacto 1/2" 590Nm regulável. com seletor de 2 velocidades/torque



BCL33IW1K1

€ 10 BCL33IW1K1
110 x 310 x 390 mm 5.77 kg 677,37

BCL33C1
BCL33IW1
BCL33B3x 2



18V Pistola de Impacto 1/2" 1.000Nm regulável Max. Performance



BCL33IW2

V € 1 BCL33IW2
18V 1/2" 554,21

18V Pistola de Impacto 1/2" 590Nm regulável



BCL33IW1

V € 1 BCL33IW1
18V 1/2" 394,01

18V Kit Pistola de Impacto 1/2" 1.000Nm regulável Max. Performance



BCL33IW2K1

€ 1 BCL33IW2K1
110 x 310 x 390 mm 6.47 kg 825,13

BCL33IW2
BCL33C1
BCL33B3x 2



ROQUETES

12V Roquete 1/4"



BCL31R1

V € 1 BCL31R1
12V 1/4" 241,41

12V Kit Roquete 1/4"



BCL31R1K1

110 x 310 x 390 mm 3.1 kg 381,82 1 BCL31R1K1

BCL31B1x 2

BCL31C1

BCL31R1

BROCAS E CHAVES DE PARAFUSOS

18V Berbequim 13mm Max. Performance



BCL33D1

18 V 1/2 in 270,92 1 BCL33D1

18V Kit Berbequim 13mm Max. Performance



BCL33D1K1

110 x 310 x 390 mm 3.7 kg 490,45 1 BCL33D1K1

BCL33C1

BCL33D1

BCL33B1x 2

12V Berbequim 3/8" 10 mm



BCL31D1

12 V 360/1550 min 167,50 1 BCL31D1

12V Kit Berbequim 3/8" 10 mm



BCL31D1K1

110 x 310 x 390 mm 3.15 kg 307,72 1 BCL31D1K1

BCL31B1x 2

BCL31C1

BCL31D1

12V Berbequim de Impacto 1/4" 105Nm



BCL31IS1

12 V 1/4 in 192,25 1 BCL31IS1

12V Kit Berbequim de Impacto 1/4"



BCL31IS1K1

110 x 310 x 390 mm 3.1 kg 332,46 1 BCL31IS1K1

BCL31B1x 2

BCL31IS1

BCL31C1

12V Berbequim 1/4" 2 Velocidades



BCL31SD1

12 V 1/4 in 167,50 1 BCL31SD1

12V Kit Berbequim 1/4" 2 Velocidades



BCL31SD1K1

110 x 310 x 390 mm 2.99 kg 307,85 1 BCL31SD1K1

BCL31SD1

BCL31B1x 2

BCL31C1



REBARBADORAS, LIXADEIRAS E POLIDORES

14,4V Lixadora Orbital 2 velocidades



BCL32SP1

V €
14.4 V 1900/6900 min 251,25 1 BCL32SP1

18V Pulidor Angular Max. Performance



BCL33AP1

V €
18 V 1100-3500 min 332,46 1 BCL33AP1

14,4V Kit Lixadora Orbital 2 velocidades



BCL32SP1K1

€
265 x 290 x 480 mm 3.29 kg 418,76 1 BCL32SP1K1

BCL32SP1

BCL32B1x 2

BCL31C1

18V Kit Pulidor Angular Max. Performance



BCL33AP1K1

€
265 x 290 x 480 mm 5.78 kg 615,75 1 BCL33AP1K1

BCL33AP1

BCL33B3x 2

BCL33C1

14,4V Amoladora 6 mm



BCL32DG1

V €
14.4 V 21000 min 197,07 1 BCL32DG1

14,4V Kit Amoladora 6 mm



BCL32DG1K1

€
110 x 310 x 390 mm 3.2 kg 370,78 1 BCL32DG1K1

BCL32DG1

BCL32B1

BCL31C1

14,4V Kit Maquina Lubrificar



BCL32G1K1

€
265 x 290 x 480 mm 5.22 kg 480,29 1 BCL32G1K1

BCL32G1

BCL31C1

BCL32B1x 2

FERRAMENTAS DE CORTE

14,4V Serra de Sabre



BCL32RS1



V €
14.4 V 3000 min 307,85 1 BCL32RS1

14,4V Kit Serra de Sabre



BCL32RS1K1

€
265 x 290 x 480 mm 3.5 kg 467,99 1 BCL32RS1K1

BCL32RS1	
BCL32B1x 2	
BCL31C1	

MASSAS LUBRIFICANTES

14,4V Maquina Lubrificar



BCL32G1

V		€		
14.4 V	400 g	320,16	1	BCL32G1

BATERIAS E CARREGADORES

12V BATERIA LI ION 2Ah



BCL31B1

V		€		
12 V	2 A-h	56,59	1	BCL31B1

14.4V BATERIA LI ION 2Ah



BCL32B1

V		€		
14.4 V	2 A-h	76,39	1	BCL32B1

18,0V BATERIA LI ION 2Ah



BCL33B1

V		€		
18 V	2 A-h	110,91	1	BCL33B1

18,0V BATERIA LI ION 5Ah





BCL33B3

V		€		
18 V	2 A-h	169,91	1	BCL33B3

CARREGADOR 12V & 14.4V



BCL31C1

V_{in}	V_{out}	€		
220 V	12/14.4 V	83,75	1	BCL31C1

CARREGADOR 18,0V



BCL33C1

V_{in}	V_{out}	€		
220 V	18 V	96,06	1	BCL33C1

CARREGADOR 18,0V ULTRA RÁPIDO



BCL33C2

V_{in}	V_{out}	€		
220 V	18 V	120,80	1	BCL33C2





BAHCO



Ferramentas para automóveis



FERRAMENTAS PARA MOTORES

Kit de sincronização para motores FCA GROUP 1.4 MULTIAIR



BE501101

68 x 225 x 280 mm € 156,18 1 BE501101

BE50110101	
BE50110102	
BE50110103	
BE50110104	

Kit de sincronização para FCA Group 0.9 gasolina Twinair



BE501102

68 x 225 x 280 mm € 157,94 1 BE501102

BE50110201	
BE50110202	
BE50110203	

Kit de sincronização para FCA Group 1.6-1.9-2.0-2.4 diesel



BE501203

68 x 225 x 280 mm € 141,37 1 BE501203

BE50120301	
BE50120302	
BE50120303	
BE50120305	
BE50110103	

Apoio de equilíbrio harmônico de cambota BMW



BE502104

60 x 98 x 269 mm 1726 g € 110,01 8 BE502104

Ferramenta de apoio de cambota BMW



BE502106

80 x 70 x 260 mm € 51,77 10 BE502106

Kit de sincronização para FCA Group 1.3 JTD MJ



BE501204

68 x 225 x 280 mm € 214,08 1 BE501204

BE50120401	
BE50120402	
BE50120403	
BE50120404	
BE50120405	

Kit de sincronização para BMW 1.8-2.0 gasolina

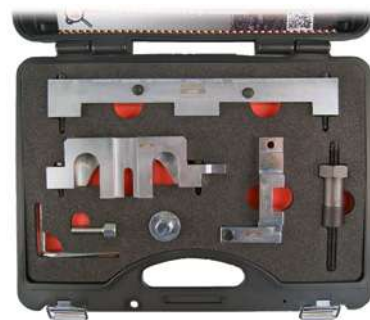

BE502101

95 x 270 x 350 mm € 468,33 1 BE502101

BE50210101	
BE50210102	
BE50210103	
BE50210104	
BE50210105	
BE50210106	
BE50210107	

Kit de sincronização para BMW 1.6 gasolina

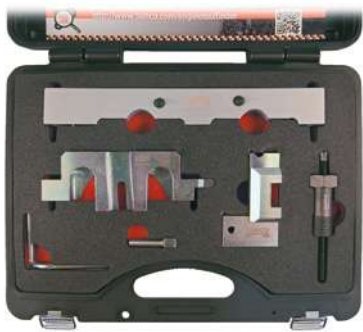

BE502102



€



270 x 95 x 355 mm

436,74

1

BE502102

BE50210103



BE50210105



BE50210107



BE50210201



BE50210202



BE50210203



Kit de sincronização para BMW 1.6-2.0 gasolina

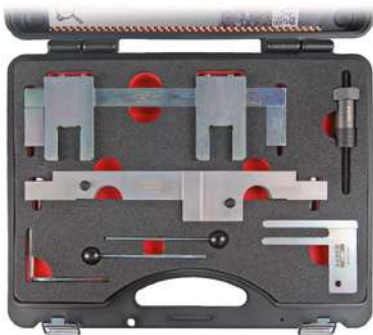

BE502103



€



80 x 300 x 375 mm

752,61

1

BE502103

BE50210301



BE50210302



BE50210303



BE50210305



BE50210105



BE50210107



Kit de sincronização para BMW 2.0 - 2.5 - 3.0 diesel



BE502204



€



68 x 225 x 280 mm

188,49

1

BE502204

BE50220401



BE50220403



BE50220404



BE50220405



BE50210305



Kit de sincronização para BMW-mini 1.6-2.0 diesel



BE503201



€



68 x 225 x 280 mm

166,96

1

BE503201

BE50320101



BE50320102



BE50320103



BE50320105



BE50210305



Kit de sincronização para MINI-PSA 1.4-1.6 gasolina



BE504102



€



95 x 270 x 350 mm

441,63

1

BE504102

BE50410201



BE50410202



BE50410203



BE50410204



BE50410206



BE50210105



Kit de sincronização para MINI-PSA 1.6 diesel



BE504201



€



50 x 50 x 220 mm

80,79

1

BE504201

BE50420101



BE50420102



BE50420103



BE50420104



BE50210305



Kit de sincronização para Ford 1.25-1.4-1.6 gasolina



BE505101

	€		
68 x 225 x 280 mm	156,18	1	BE505101

BE50510101	
BE50510102	
BE50510103	
BE50510104	
BE50510105	
BE50510106	

Kit de sincronização para FORD 1.0 ECOBOOST gasolina



BE505102

	€		
95 x 270 x 350 mm	677,07	1	BE505102

BE50510201	
BE50510202	
BE50510203	
BE50510204	
BE50420102	
BE50510102	

Kit de sincronização para FORD 2.0 - 2.2 - 2.4 Duratorq TDCI 16v diesel



BE505203

	€		
95 x 270 x 350 mm	242,36	1	BE505203

BE50520301	
BE50520302	
BE50520303	
BE50520304	
BE50520305	
BE50520306	
BE50520307	

Kit de sincronização para Ford 1.4-1.6-1.8-2.0-2.2-2.5 diesel



BE505204

	€		
95 x 270 x 350 mm	231,58	1	BE505204

BE50520401	
BE50520402	
BE50520403	
BE50520404	
BE50520405	
BE50520407	
BE50520411	
BE50520412	
BE50520413	
BE50510104	
BE50420102	
BE50420103	
BE50420104	
BE50510106	

Kit de sincronização para Opel 1.0-1.2-1.4 gasolina



BE506101

	€		
50 x 50 x 160 mm	210,12	1	BE506101

BE50610101	
BE50610102	
BE50610103	
BE50610104	
BE50610105	

Kit de sincronização para Opel 1.4-1.6-1.8 gasolina



BE506102

	€		
68 x 225 x 280 mm	185,40	1	BE506102

BE50610201	
BE50610202	
BE50610203	
BE50610204	
BE50610205	
BE50610206	

Kit de sincronização para Opel 1.0-1.2-1.4 Ecoflex gasolina



BE506103

95 x 270 x 350 mm € 495,78 1 BE506103

- BE50610302
- BE50610304
- BE50610102
- BE50610103
- BE50610105

Kit de sincronização para Opel 2.0 diesel



BE506204

85 x 300 x 375 mm € 288,41 1 BE506204

- BE50620401
- BE50620402
- BE50620403
- BE50620404
- BE50620405

Kit de sincronização para PSA 1.0-1.1-1.4-1.6-1.8-2.0-2.2 gasolina



BE507101

95 x 270 x 350 mm € 384,55 1 BE507101

- BE50710103
- BE50710104
- BE50710105
- BE50710106
- BE50710107
- BE50710108
- BE50710109
- BE50710110
- BE50710111
- BE50710112
- BE50710101
- BE50710102
- BE50710113
- BE50710114
- BE50710116
- BE50710117
- BE50710118
- BE50710119
- BE50420104

Kit de sincronização para PSA 1.0-1.2 gasolina



BE507102

68 x 225 x 280 mm € 410,63 1 BE507102

- BE50710201
- BE50710202

Kit de sincronização para PSA 1.4-1.5-1.6-1.9-2.0-2.2-2.5 diesel



BE507203

85 x 300 x 375 mm € 403,93 1 BE507203

- BE50720301
- BE50720302
- BE50720304
- BE50720305
- BE50720307
- BE50720308
- BE50720310
- BE50720312
- BE50720314
- BE50720317
- BE50720318
- BE50720319
- BE50720320
- BE50720321
- BE50720322
- BE50720323
- BE50520404
- BE50520411
- BE50710107
- BE50710104
- BE50710113
- BE50710110
- BE50710102
- BE50710106
- BE50420102
- BE50420103



Kit de sincronização para Renault/Dacia 1.2-1.4-1.6-1.8-2.0 gasolina

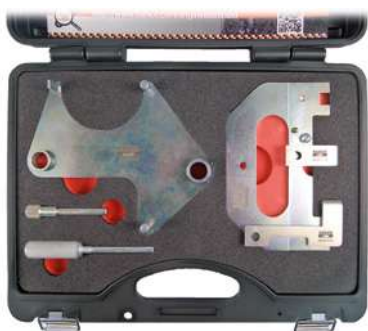

BE508101

	€		
95 x 270 x 350 mm	234,29	1	BE508101

BE50810101	
BE50810102	
BE50810103	
BE50810104	
BE50810105	
BE50810106	

Kit de sincronização para Renault 1.5-1.9-2.2-2.5 gasolina



BE508202

	€		
80 x 300 x 375 mm	315,07	1	BE508202

BE50820201	
BE50820202	
BE50820203	
BE50820204	
BE50820205	
BE50820206	
BE50820207	
BE50820208	
BE50820209	
BE50820211	
BE50810103	
BE50810104	

Kit de sincronização para Renault 2.0 diesel



BE508203

	€		
68 x 225 x 280 mm	296,64	1	BE508203

BE50820301	
BE50820302	
BE50820303	
BE50820304	
BE50210305	

Kit de sincronização para Renault-Nissan 1.6 diesel



BE508204

	€		
95 x 270 x 350 mm	421,63	1	BE508204

BE50820402	
BE50820403	
BE50820404	
BE50820302	

Kit de sincronização para VW Group 1.4-1.6-1.8-2.0 gasolina



BE509101

	€		
80 x 300 x 375 mm	274,68	1	BE509101

BE50910101	
BE50910102	
BE50910103	
BE50910104	
BE50910105	
BE50910106	
BE50910107	
BE50910108	
BE50910109	
BE50910110	
BE50910111	
BE50910112	
BE50910114	
BE50520302	

Kit de sincronização para VW Group 1.2-1.4-1.6 gasolina



BE509102

	€		
68 x 225 x 280 mm	458,71	1	BE509102

BE50910201	
BE50910202	
BE50910203	
BE50910205	
BE50910206	
BE50910207	
BE50520302	

Kit de sincronização para VW Group 1.2 TSI gasolina



BE509103

	€		
50 x 50 x 210 mm	79,45	1	BE509103

BE50910302	
BE50910203	

Timing kit for VW Group 1.0 petrol



BE509104

	€		
68 x 225 x 280 mm	479,31	1	BE509104

BE50910401	
BE50910402	
BE50910403	
BE50910404	
BE50910203	

Timing kit for VW Group 1.2-1.4-1.6-1.9-2.0 diesel



BE509205_1

	€		
60 x 60 x 220 mm	70,02	1	BE509205

BE50910103	
BE50920602	
BE50920603	

Kit de sincronização para VW Group 1.9-2.0 gasolina



BE509206

	€		
60 x 60 x 220 mm	71,38	1	BE509206

BE50920602	
BE50910103	
BE50920703	

Timing kit for VW Group 1.2-1.4-1.6-1.9-2.0 diesel

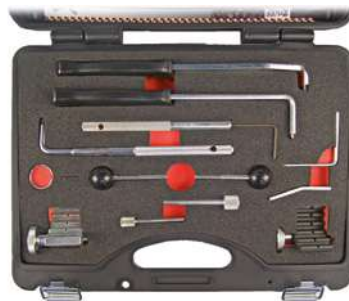

BE509207

	€		
95 x 270 x 350 mm	282,76	1	BE509207

BE50920703	
BE50920707	
BE50920708	
BE50920709	
BE50920710	
BE50920711	
BE50910103	
BE50910112	
BE50920602	
BE50920603	
BE50910109	
BE50510102	

Kit de sincronização para VOLVO 1.6 - 1.8 - 1.9 - 2.0 - 2.3 - 2.4 - 2.5 gasolina



BE510101

	€		
60 x 60 x 355 mm	240,34	1	BE510101

BE51010101	
BE51010102	
BE51010103	

Timing kit for VOLVO 1.6 - 1.8 - 2.0 16v. petrol



BE510102

	€		
50 x 50 x 220 mm	53,60	1	BE510102

BE51010201	
BE51010202	
BE50510102	
BE50510105	
BE50510106	



Kit de sincronização para VOLVO 1.6 - 2.0 diesel



BE510203

68 x 225 x 280 mm € 186,78 1 BE510203

- BE50420102
- BE50420103
- BE50420104
- BE50520407
- BE50520411
- BE50510104

Polia da cambota par aVolvo



BE510304

50 x 145 x 265 mm € 116,74 1 BE510304

Kit de sincronização para SAAB 1.8i gasolina



BE511101

50 x 50 x 220 mm € 79,65 1 BE511101

- BE51110101
- BE51110102
- BE50610201
- BE50610204

Kit de sincronização para SAAB 1.6t gasolina



BE511102

50 x 50 x 207 mm € 63,17 1 BE511102

- BE50610201
- BE50610202
- BE50610205
- BE50610203

Kit de sincronização para SAAB 1.9 - 2.0 - 2.2 Tid gasolina



BE511203

80 x 300 x 375 mm € 336,61 1 BE511203

- BE51120301
- BE51120302
- BE51120303
- BE51120304
- BE51120305
- BE50120302
- BE50120303
- BE50120305
- BE50610201

KIT FERRAMENTAS DE REMOÇÃO DE VELAS INCANDESCENTES M8-M9-M10



BE513201

95 x 270 x 350 mm 2.10 kg € 531,85 1 BE513201

- BE51320101
- BE51320102
- BE51320103
- BE51320104
- BE51320105
- BE51320106
- BE51320107
- BE51320108
- BE51320109
- BE51320110
- BE51320111
- BE51320112
- BE51320113
- BE51320114

Alavanca segurar polias. Universal.



BE523106

410 mm € 62,01 1 BE523106

Universal.

Ferramenta de bloqueio de árvore de cames universal ajustável



BE5100

	€		
345 x 150 x 85 mm	95,67	1	BE5100

talador. / Remover Correias. Gama: diâmetro polia de 80-350mm



BE230

	€		
35 x 145 x 155 mm	179,00	1	BE230

Gama: diâmetro polia de 80-350mm

Jogo extracção polia do alternador. 24 pcs



BE500P24

	€		
55 x 270 x 370 mm	148,11	5	BE500P24
	11,56	1	BE500P2401
	11,26	1	BE500P2402
	12,52	1	BE500P2403
	12,68	1	BE500P2404
	13,51	1	BE500P2405
	17,44	1	BE500P2406
	17,44	1	BE500P2407
	6,53	1	BE500P2408



€		
6,47	1	BE500P2409
6,47	1	BE500P2410
6,47	1	BE500P2411
6,47	1	BE500P2412
6,47	1	BE500P2413
17,60	1	BE500P2414
11,96	1	BE500P2415
11,31	1	BE500P2416
11,12	1	BE500P2417
11,56	1	BE500P2418
11,12	1	BE500P2419
11,56	1	BE500P2420
11,56	1	BE500P2421
17,44	1	BE500P2422
11,26	1	BE500P2423
11,26	1	BE500P2424

24 pcs.

Manómetro de pressão de motor a diesel



BE5401D

	€		
105 x 325 x 410 mm	658,42	1	BE5401D

Manómetro de pressão de motor a gasolina



BE5400P

	€		
70 x 160 x 260 mm	181,78	1	BE5400P

Comprovador tensão de correias



BE239

		€		
38 x 82 x 95 mm	95 mm	94,25	1	BE239

Comprovador tensão de correias



BE240

		€		
60 x 270 x 315 mm	315 mm	992,74	1	BE240

Livro valores tensão p/correias dentadas e acessórios, sincronizadas, V&V e com nervuras



BE240-CAT

	€		
710 g	107,72	1	BE240-CAT



Termómetro Laser



BLT550

		€		
-50 +550 °C	40 x 95 x 145 mm	75,40	10	BLT550

Conjunto de tampões para fluido e separador de mangueira injectora



BE257

	€		
68 x 225 x 280 mm	103,36	8	BE257
	17,11	1	BE25710
	17,11	1	BE25718
	12,13	1	BE2572
	15,04	1	BE2576

Kit de desmontagem de injectores



BE512201

	€		
140 x 415 x 600 mm	2.181,26	1	BE512201

BE51220101	
BE51220102	
BE51220103	
BE51220104	
BE51220105	
BE51220106	
BE51220107	
BE51220108	
BE51220109	
BE51220110	
BE51220111	
BE51220112	
BE51220113	
BE51220114	
BE51220115	
BE51220116	
BE51220117	
BE51220118	
BE51220119	
BE51220120	

Conjunto de ferramentas de remoção de injectores



BE1311P13

	€		
80 x 355 x 445 mm	422,79	1	BE1311P13

Chaves de caixa de injeção, 25-27-29-30mm



BE1310P4

	€		
68 x 225 x 225 mm	114,46	1	BE1310P4

Chaves impacto para remover pontas de injeção



BE1310P425-BE1310P430

		€		
25 mm	1/2 in	27,49	1	BE1310P425
27 mm	1/2 in	30,09	1	BE1310P427
29 mm	1/2 in	32,47	1	BE1310P429
30 mm	1/2 in	32,47	1	BE1310P430

Conjunto de limpador de assentos de injectores de diesel



BE1320S17

	€		
76 x 266 x 355 mm	118,63	10	BE1320S17

Conjunto para sede de injetor de diesel



BE1315P7

	€		
68 x 225 x 280 mm	121,04	1	BE1315P7
25 x 180 x 275 mm	23,45	1	BE1315P71
20 x 93 x 175 mm	19,67	1	BE1315P72
19 x 93 x 140 mm	24,36	1	BE1315P73
16 x 93 x 140 mm	23,81	1	BE1315P74
20 x 56 x 96 mm	23,81	1	BE1315P75
20 x 56 x 96 mm	24,36	1	BE1315P76
23 x 56 x 96 mm	26,88	1	BE1315P77

Martelo deslizante / extrator de braço de escova pára-brisas e anilha de injetor



BE1300SH

	€		
235 mm	49,82	10	BE1300SH

Ferramenta especial de remoção de assento de válvula interna para injetores Denso Common Rail



BE1312DNS

	€		
	11,44	12	BE1312DNS

Extrator para anilha de injetor de diesel



BE1300

	€		
230 mm	95,60	1	BE1300

Conjunto de lapidação de válvula



BE762

	g	€	
30 x 90 x 315 mm	68 g	12,88	12 BE762

Alicate de remoção de válvulas de veículos ligeiros



BE76101

	€		
40 x 200 x 290 mm	62,49	1	BE76101

Conjunto de injetor de cobre para anéis de retenção



BE1305P450

	€		
40 x 140 x 205 mm	333,91	1	BE1305P450

Conjuntos de 30 anilhas para injetores

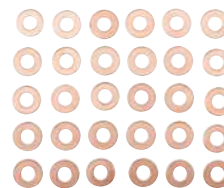

BE1305P450B

	€		
	24,55	1	BE1305P450WS01
	13,24	1	BE1305P450WS02
	20,92	1	BE1305P450WS03
	25,05	1	BE1305P450WS04
	28,63	1	BE1305P450WS05
	32,75	1	BE1305P450WS06
	20,33	1	BE1305P450WS07
	21,53	1	BE1305P450WS08
	26,25	1	BE1305P450WS09
	28,63	1	BE1305P450WS10
	29,16	1	BE1305P450WS11
	17,41	1	BE1305P450WS12
	13,24	1	BE1305P450WS13
	13,24	1	BE1305P450WS14
	29,16	1	BE1305P450WS15

Testador de combustível Common rail 8 injetores



BE5350

	€		
84 x 341 x 447 mm	262,57	5	BE5350
10 x 56 x 96 mm	40,00	1	BE5350C1
10 x 56 x 96 mm	40,00	1	BE5350C2
10 x 56 x 96 mm	40,00	1	BE5350C3
10 x 56 x 96 mm	20,68	1	BE5350C4
115 x 65 x 205 mm	168,80	1	BE5350C5



Bomba para teste de injectores diesel



BE13ZL11

		€		
480 x 230 x 280 mm	4.24 kg	605,90	1	BE13ZL11

Kit bits Torx Plus inviolável
8 Peças



BE5008

	€		
40 x 20 x 175 mm	102,21	1	BE5008

BE5008-45, BE5008-27, BE5008-25,
BE5008-40, BE5008-30, BE5008-10,
BE5008-20, BE5008-15

Encaixe Torx Plus inviolável
1/4"



BE5008-10/BE5008-45

	€		
10	15,75	1	BE5008-10
15	15,75	1	BE5008-15
20	15,75	1	BE5008-20
25	15,75	1	BE5008-25
27	15,75	1	BE5008-27
30	15,75	1	BE5008-30
40	15,75	1	BE5008-40
45	15,75	1	BE5008-45

Jogo chaves de velas



BE1GP5

		€		
1/4 in	110 x 240 x 40 mm	65,01	1	BE1GP5

BE1GP514, BE1GP510, BE1GP512,
BE1GP58, BE1GP59

Extratores de velas incandescentes



BE1205

		€		
130 mm	35 x 35 x 130 mm	80,79	1	BE1205

Conj. 5 inserções/bobinas p/reparar/
restaurar roscas de velas danificadas



BE1210P110x

		€		
M8x1	50 g	12,58	1	BE1210P1101
M10x1	50 g	13,57	1	BE1210P1102
M10x1,25	50 g	13,57	1	BE1210P1103

Conjunto de limpeza para câmara de velas
de velas incandescentes. Broca guia
BE1200P6AC1



BE1200P6

	€		
50 x 115 x 260 mm	152,72	1	BE1200P6

Broca guia BE1200P6AC1

Conjunto de limpeza para câmara de velas
incandescentes



BE1200P6AC1

	€		
50 x 158 x 192 mm	108,56	1	BE1200P6AC1

Chave em "T" para mudança de velas



BE1GP5-T

		€		
1/4 in	400 mm	29,17	10	BE1GP5-T

Chaves de caixa flexíveis para velas incandescentes



BE1GP58/BE1GP514



Ø	L	€	Box	Icon
8 mm	70 mm	22,52	1	BE1GP58
9 mm	70 mm	22,52	1	BE1GP59
10 mm	70 mm	22,52	1	BE1GP510
12 mm	70 mm	22,52	1	BE1GP512
14 mm	70 mm	22,52	1	BE1GP514

Ferramenta de extensão articulada para velas de ignição



BE1SP1F

Ø	L	€	Box	Icon
30 mm	21 x 330 x 330 mm	28,52	12	BE1SP1F

chave de caixas de vela de ignição de 3/8" de secção quadrada



7402GPR

Ø	€	Box	Icon
16 mm	2,94	120	7402GPR-16
18 mm	5,05	120	7402GPR-18
21 mm	3,46	100	7402GPR-21

Conjunto de reparação de rosca de velas incandescentes



BE1210P11

Box	€	Box	Icon
50 x 120 x 260 mm	157,54	1	BE1210P11
112 x 13 x 95 mm	107,75	1	BE1210P9AC1

Chave de velas magnética



7406ZZ

Ø	L	€	Box	Icon
16 mm	65 mm	31,97	1	7406ZZ-16
21 mm	64 mm	31,97	1	7406ZZ-21

Chave de Velas. Bi-Hexagonal 14 mm com sistema retenção



BE1SP

Ø	L	€	Box	Icon
3/8 in	252 mm	26,80	10	BE1SP16L
3/8 in	252 mm	26,80	1	BE1SP14L

Bi-Hexagonal 14 mm com sistema retenção

Alicate de velas



BE1P

L	Box	€	Box	Icon
290 mm	20 x 50 x 290 mm	76,05	1	BE1P

chave de caixas de vela de ignição de 1/2" com acionamento quadrado



7805GPR

Ø	L	€	Box	Icon
16 mm	64 mm	4,87	120	7805GPR-16
21 mm	64 mm	5,30	100	7805GPR-21

Chave de velas Profissional



BE1T14/BE1T16/BE1T21

Ø	L	€	Box	Icon
14 mm	65/310 mm	34,74	1	BE1T14
16 mm	63/450 mm	39,72	1	BE1T16
21 mm	67/450 mm	39,14	1	BE1T21



BE110014/Macho: M14 x 1,25P



BE110014/BE110015

g	€		
55 g	20,92	1	BE110014
55 g	102,28	1	BE110015

Bobinas de inserir para reparação de roscas de velas



BE1100AC1/BE1100AC2

L	€		
9.4 mm	68,12	1	BE1100AC1
15 mm	21,21	1	BE1100AC2

Conjunto de chaves impacto 1/2' com bits Ribe apropriado para motores. 9 peças



BE5102

L	€		
65 x 225 x 225 mm	95,96	1	BE5102

9 peças

BE51026, BE51025, BE510210,
BE510211, BE510212, BE510213,
BE51027, BE51028, BE51029

Chave de caixa 1/2' com bits RIBE



BE51025-BE510213

	L	€		
RM5	100 mm	7,87	1	BE51025
RM6	100 mm	7,87	1	BE51026
RM7	100 mm	7,87	1	BE51027
RM8	100 mm	8,25	1	BE51028
RM9	100 mm	8,25	1	BE51029
RM10	100 mm	8,25	1	BE510210
RM11	100 mm	9,63	1	BE510211
RM12	100 mm	10,01	1	BE510212
RM13	100 mm	12,37	1	BE510213

Conjunto de chaves impacto 1/2' com bits XZN, apropriado para motores. 6 peças



BE5103

L	€		
65 x 225 x 225 mm	85,62	1	BE5103

6 peças

BE51036, BE51038, BE510310,
BE510312, BE51035, BE510314

Chave de caixa 1/2' com bits XZN



BE51035-BE510314

	L	€		
M5	140 mm	8,21	1	BE51035
M6	140 mm	8,21	1	BE51036
M8	140 mm	8,21	1	BE51038
M10	140 mm	8,21	1	BE510310
M12	140 mm	9,94	1	BE510312
M14	140 mm	13,62	1	BE510314

Escova de aço para vela



52

L	€		
150 mm	4,33	12	52

Escova de aço para uso geral



782-U

L	€		
285 mm	6,69	1	782-U

Escova terminal



2555

L	€		
85 mm	8,19	1	2555

Reparador de rosca de velas



BE1100

		€		
68 x 225 x 280 mm	1.55 kg	324,81	8	BE1100

Fresa



BE110001

	€		
60 g	60,93	1	BE110001

Alicate para Segmentos



BE74-55100/BE74-80120

		€		
55-100 mm	20 x 130 x 205 mm	47,18	1	BE74-55100
80-120 mm	20 x 145 x 220 mm	50,02	1	BE74-80120

Cinta de segmentos de pistão



BE74-57125/BE74-90175

		€		
80 mm	57-125 mm	48,58	1	BE74-57125
165 mm	90-175 mm	72,86	1	BE74-90175
80 mm	57-125 mm	52,89	1	BE74-57125L

Refratômetro



3046-REF

	€		
150 mm	133,31	1	3046-REF

Comprovador de liquido anti-congelante



BE401

		€		
50 x 50 x 235 mm	235 mm	10,69	1	BE401

Testador de pressão para sistemas de arrefecimento



BE400P24

	€		
127 x 435 x 510 mm	424,13	1	BE400P24

Bomba de pressão do radiador com calibrador para testar sistemas de arrefecimento ou aquecimento



BE400P241

BAR	PSI	€		
0-2,5 bar	0-36 psi	113,96	1	BE400P241

Conector de teste da tampa de radiador R124/R123



BE400P242

	€		
0.035 kg	11,59	1	BE400P242



Conector de teste da tampa de radiador R123/R125



BE400P243

	€		
0,06 kg	11,59	1	BE400P243

Verificador da tampa do radiador p/sistema de arrefecimento



BE400P2402

	€		
65 mm	27,90	1	BE400P2402

Adaptador para testar o sistema de arrefecimento



BE400P2405

	€		
0,065 kg	16,08	1	BE400P2405

Termómetro 0-200 °C



BE400P244

	€		
0,02 kg	22,44	1	BE400P244

Verificador da tampa do radiador p/sistema de arrefecimento



BE400P2403

	€		
43,5 mm	24,68	1	BE400P2403

Adaptador para testar o sistema de arrefecimento



BE400P2406

	€		
0,065 kg	16,08	1	BE400P2406

Verificador da tampa do radiador p/sistema de arrefecimento



BE400P2401

	€		
65 mm	27,90	1	BE400P2401

Adaptador para testar o sistema de arrefecimento



BE400P2404

	€		
0,055 kg	16,08	1	BE400P2404

Adaptador para testar o sistema de arrefecimento



BE400P2407

	€		
0,065 kg	16,08	1	BE400P2407

Adaptador para testar o sistema de arrefecimento



BE400P2408

kg € 0.075 kg 16,08 1 BE400P2408

Adaptador para testar o sistema de arrefecimento



BE400P2411

kg € 0.11 kg 16,08 1 BE400P2411

Adaptador para testar o sistema de arrefecimento



BE400P2414

kg € 0.11 kg 16,99 1 BE400P2414

Adaptador para testar o sistema de arrefecimento



BE400P2409

kg € 0.11 kg 16,08 1 BE400P2409

Adaptador para testar o sistema de arrefecimento



BE400P2412

kg € 0.085 kg 16,08 1 BE400P2412

Adaptador para testar o sistema de arrefecimento



BE400P2415

kg € 0.075 kg 17,29 1 BE400P2415

Adaptador para testar o sistema de arrefecimento



BE400P2410

kg € 0.085 kg 16,08 1 BE400P2410

Adaptador para testar o sistema de arrefecimento



BE400P2413

kg € 0.065 kg 16,08 1 BE400P2413

Adaptador para testar o sistema de arrefecimento



BE400P2416

kg € 0.065 kg 16,99 1 BE400P2416



Adaptador para testar o sistema de arrefecimento



BE400P2417

	€		
0.11 kg	16,99	1	BE400P2417

Adaptador para testar o sistema de arrefecimento



BE400P2418

	€		
0.045 kg	16,99	1	BE400P2418

Adaptador para testar o sistema de arrefecimento



BE400P2419

	€		
0.075 kg	16,99	1	BE400P2419

Chave de plástico para tampa do radiador



BE400P2420

	€		
0.005 kg	42,89	1	BE400P2420

Reabastecedor de sistemas de arrefecimento, vácuo. BE4101 é um adaptador cónico



BE410

	€		
80 x 300 x 375 mm	263,90	4	BE410
45 x 45 x 105 mm	11,58	1	BE4101

BE4101 é um adaptador cónico

Conjunto de separador de juntas



BE700

	€		
90 x 200 x 43 mm	85,56	1	BE700
	78,86	1	BE700BP2
	37,19	1	BE700SP15

Conjunto de bits 10mm. 32peças



BE5032

	€		
65 x 225 x 225 mm	90,95	1	BE5032

32peças

BE5049M5, BE5049M6, BE5049M8, BE5049M10, BE5049M12, BE5032M14		
BE5049T20, BE5049T25, BE5049T27, BE5049T30, BE5049T40, BE5049T45, BE5049T50, BE5049T55, BE5049T60		
BE5049H5, BE5049H6, BE5049H8, BE5049H10, BE5049H12, BE5032H14		
BE5032SQ8, BE5032SQ10		
BE5049H6L, BE5049H8L, BE5032H10EL		
BE5049T45L, BE5032T55EL		
BE5049M8L, BE5049M10L, BE5049M12L		
BE504901		

Bits para parafusos de cabeça Robertson, métrico, 10mm



BE5032SQ



		€		
#8 mm	30 mm	24,77	1	BE5032SQ8
#10 mm	30 mm	29,94	1	BE5032SQ10

Chave de impacto 1/2" com bits Tx de segurança



BE510125-BE510160



		€		
TR25	100 mm	7,08	1	BE510125
TR27	100 mm	7,08	1	BE510127
TR30	100 mm	7,08	1	BE510130

		€		
TR40	100 mm	7,08	1	BE510140
TR45	100 mm	7,43	1	BE510145
TR50	100 mm	7,43	1	BE510150
TR55	100 mm	7,43	1	BE510155
TR60	100 mm	8,89	1	BE510160

Kit instalação de vedantes de cambota e árvore de cames



BE5150P27

	€		
80 x 270 x 375 mm	370,90	1	BE5150P27
56 x 56 x 96 mm	123,06	1	BE5150P271
80 x 80 x 195 mm	34,37	1	BE5150P272
170 x 160 x 385 mm	224,42	1	BE5150P273

Conjunto de ferramentas para reparação de Ar Condicionado



BE800P12

	€		
43 x 90 x 200 mm	72,72	1	BE800P12

Conectores para ar condicionado e tubo de combustível



BAC007

	kg	€		
240 mm	0,075 kg	12,12	1	BAC007

Barra Suporte Motor. Capacidade 500 Kg



BH8AC1-500

	kg	€		
150 x 165 x 1800 mm	20,71 kg	160,11	1	BH8AC1-500

Capacidade 500 Kg

Suporte para máquinas com engrenagem até 500 kg



BH8AC2-500

	€		
500 kg	472,24	1	BH8AC2-500

Alicates braçadeira de mangueira -45°



BE250

	g	€		
190 mm	245 g	47,13	1	BE250

Alicate para abraçadeiras de mangueira



BE251A

	g	€		
30 x 55 x 220 mm	228 g	47,13	12	BE251A

Alicate para braçadeiras do tipo EGR



BE253

	€		
870 mm	119,84	1	BE253



Chave de roquete compacta padrão e para abraçadeiras



BE254A

	€		
18-53 mm	112,93	1	BE254A

Cabo



BE2542

		€		
630 mm	20 g	6,33	1	BE2542

Alicate de aperto OETIKER™



BPOC15

	€		
275 mm	79,47	12	BPOC15

Cabo sobresselente para alicates BE254A



BE254A-01

		€		
590 mm	130 g	41,05	1	BE254A-01

braçadeira de mangueira metálica



BE256M

	€		
40 x 45 x 310 mm	45,76	1	BE256M

Conjunto de alicate para braçadeira de mangueira



BE256P3

	€		
40 x 93 x 330 mm	33,67	1	BE256P3
15 x 55 x 155 mm	9,43	1	BE256-155
20 x 45 x 185 mm	12,12	1	BE256-178
10 x 55 x 250 mm	16,15	1	BE256-250

Kit de reparação para BE254



BE2541

	€		
100 g	16,58	1	BE2541

Alicate para braçadeiras elástico



BE258

		€		
12-55 mm	285 mm	124,62	1	BE258

Conjunto de chaves de caixa ranhuradas



BE5500

	€		
10/11/12/14/17/19	53,06	25	BE5500

Chaves de fenda



BE5500-10/BE-5500-19

		€		
3/8 in	10	9,84	1	BE550010
3/8 in	11	9,84	1	BE550011
3/8 in	12	9,84	1	BE550012
3/8 in	14	9,84	1	BE550014
1/2 in	17	10,29	1	BE550017
1/2 in	19	10,61	1	BE550019

Alicate de ligação para filtros de linha de combustível



BE6FCP

		€		
104 mm	218 mm	44,41	30	BE6FCP

Conjunto de alicates de descontinuação de tubo de combustível



BE1FLDS

	€		
8-10 mm	44,44	1	BE1FLDS

BE1FLD2, BE1FLD3, BE1FLD1

Alicate para desconectar tubo de combustível



BE1FLD1/BE1FLD3

	€		
10 mm	16,30	1	BE1FLD1
8 mm	16,30	1	BE1FLD2
18.5 mm	16,30	1	BE1FLD3

Extractor para indicador de combustível



BE1FTW

	€		
75-160 mm	67,86	1	BE1FTW

Chave de filtro de combustível para Ford 2.2TDCi



BE1FFWF

	€		
5 x 142 x 169 mm	23,56	12	BE1FFWF

Conjunto para extração de vedantes e mangueira de pesca



2633HD/S6

	€		
80 x 270 x 375 mm	132,85	1	2633HD/S6
42 x 93 x 290 mm	43,12	1	2633HD1
30 x 85 x 215 mm	19,07	1	2633HD2
30 x 93 x 200 mm	16,54	1	2633HD3
20 x 87 x 165 mm	12,77	1	2633HD4
10 x 60 x 120 mm	12,04	1	2633HD5
10 x 10 x 155 mm	6,95	1	2633HD6

Conjunto de chaves sextavadas métricas com pega em T - 5 peças



BE1TH-S5

	€		
5	88,76	1	BE1TH-S5

Conj. 6 punhos em T. p/paraf. c/cabeça Allen - hex 2,5-3-4-5-6 e 8 mm



BE1TH-S6

	€		
6	99,64	30	BE1TH-S6

BE1TH-4, BE1TH-8, BE1TH-2.5, BE1TH-3, BE1TH-6, BE1TH-5



Punho em T para parafusos com cabeça Allen - hex



BE1TH

mm	g	€	Box	Fish	Code
10 mm	385 g	29,95	5		BE1TH-10
12 mm	571 g	36,37	5		BE1TH-12
2 mm	15 g	17,23	10		BE1TH-2
2.5 mm	20 g	17,23	10		BE1TH-2.5
3 mm	23 g	17,70	10		BE1TH-3
3.5 mm	23 g	17,70	10		BE1TH-3.5
4 mm	60 g	20,13	10		BE1TH-4
4.5 mm	60 g	20,86	10		BE1TH-4.5
5 mm	60 g	21,54	10		BE1TH-5
6 mm	127 g	23,84	10		BE1TH-6
7 mm	205 g	27,42	10		BE1TH-7
8 mm	205 g	27,42	10		BE1TH-8
9 mm	385 g	29,95	10		BE1TH-9

Conj. 7 punhos em T c/chaves de caixa artic. 7-8-10-12-13-14 e 17 mm, 500 mm de comprimento



BE1TS-S7

€	Box	Fish	Code
187,94	1		BE1TS-S7

BE1TS-17, BE1TS-13, BE1TS-14, BE1TS-12, BE1TS-7, BE1TS-8, BE1TS-10

Punho em T c/chave de caixa articulada, 500 mm compr.



BE1TS

mm	g	€	Box	Fish	Code
10 mm	485 g	29,62	10		BE1TS-10
11 mm	485 g	29,88	10		BE1TS-11
12 mm	475 g	30,69	10		BE1TS-12
13 mm	485 g	31,37	10		BE1TS-13
14 mm	485 g	31,37	10		BE1TS-14
15 mm	485 g	34,00	10		BE1TS-15
16 mm	495 g	34,00	10		BE1TS-16
17 mm	495 g	34,00	10		BE1TS-17
18 mm	510 g	37,16	10		BE1TS-18
19 mm	495 g	37,16	10		BE1TS-19
20 mm	730 g	43,90	8		BE1TS-20
21 mm	765 g	24,56	8		BE1TS-21
22 mm	745 g	44,03	8		BE1TS-22
24 mm	745 g	40,26	8		BE1TS-24
6 mm	475 g	25,86	10		BE1TS-6
7 mm	475 g	25,86	10		BE1TS-7
8 mm	485 g	28,42	10		BE1TS-8
9 mm	475 g	29,62	10		BE1TS-9

Barra com pega em T e suporte de aluminio rotativo



1945W

mm	mm	€	Box	Fish	Code
1/2 in	311 mm	56,41	6		1945W12
1/4 in	311 mm	36,88	8		1945W14
3/8 in	311 mm	44,47	6		1945W38

Jogo Bits 10 mm. 49 peças



BE5049

mm	kg	€	Box	Fish	Code
55 x 190 x 320 mm	3.56 kg	114,46	5		BE5049

49 peças

Adaptador 1/2" para bits 10mm



BE504901

mm	mm	€	Box	Fish	Code
10 mm	36 mm	12,35	1		BE504901

Bits Hexagonais métricos, 10mm



BE5049H

mm	mm	€	Box	Fish	Code
4 mm	30 mm	14,92	1		BE5049H4
5 mm	30 mm	14,92	1		BE5049H5
6 mm	30 mm	14,92	1		BE5049H6
7 mm	30 mm	14,92	1		BE5049H7
8 mm	30 mm	14,92	1		BE5049H8
10 mm	30 mm	14,92	1		BE5049H10
12 mm	30 mm	18,57	1		BE5049H12
14 mm	30 mm	31,45	1		BE5032H14

Bits XZN, 10mm



BE5049M

	L	€		
M5	30 mm	14,92	1	BE5049M5
M6	30 mm	14,92	1	BE5049M6
M8	30 mm	14,92	1	BE5049M8
M10	30 mm	14,92	1	BE5049M10
M12	30 mm	18,57	1	BE5049M12
M14	30 mm	35,39	1	BE5032M14

Bits para parafusos TORX®, 10mm



BE5049T

	L	€		
T20	30 mm	14,42	1	BE5049T20
T25	30 mm	14,42	1	BE5049T25
T27	30 mm	14,42	1	BE5049T27
T30	30 mm	14,42	1	BE5049T30
T40	30 mm	14,42	1	BE5049T40
T45	30 mm	14,42	1	BE5049T45
T50	30 mm	14,42	1	BE5049T50
T55	30 mm	14,42	1	BE5049T55
T60	30 mm	21,12	1	BE5049T60

Bits TORX®, 10mm



BE5049T_H

	L	€		
TR20	30 mm	14,92	1	BE5049T20H
TR25	30 mm	14,92	1	BE5049T25H
TR27	30 mm	14,92	1	BE5049T27H
TR30	30 mm	14,92	1	BE5049T30H
TR40	30 mm	14,92	1	BE5049T40H
TR45	30 mm	14,92	1	BE5049T45H
TR50	30 mm	14,92	1	BE5049T50H

	L	€		
TR55	30 mm	14,92	1	BE5049T55H
TR60	30 mm	21,60	1	BE5049T60H

Conjunto de chaves impacto 1/2" com bits Tx de segurança, apropriado para motores. 9peças



BE5101

	€		
65 x 225 x 225 mm	95,96	1	BE5101

9peças

BE510150, BE510145, BE510160, BE510155, BE510127, BE510125, BE510140, BE510130

Conjunto de testadores para pressão de óleo de motor



BE5200

	€		
85 x 355 x 445 mm	200,63	1	BE5200
25 x 105 x 195 mm	167,26	1	BE530001
	22,84	1	BE52001
	22,84	1	BE52002
	104,45	1	BE52003

Adaptador 3/8" para bits 10 mm



BE504902

	L	€		
10 mm	28 mm	10,07	1	BE504902

Bits Hexagonais métricos, 10mm. Série Longa



BE5049H_L

	L	€		
4 mm	75 mm	22,12	1	BE5049H4L
5 mm	75 mm	22,12	1	BE5049H5L
6 mm	75 mm	22,12	1	BE5049H6L
7 mm	75 mm	22,12	1	BE5049H7L
8 mm	75 mm	22,12	1	BE5049H8L
10 mm	75 mm	22,12	1	BE5049H10L
10 mm	115 mm	10,74	1	BE5032H10EL
12 mm	75 mm	29,69	1	BE5049H12L

Série Longa

Bits XZN, 10mm. Série Longa 75mm



BE5049M_L

	L	€		
M5	75 mm	22,12	1	BE5049M5L
M6	75 mm	22,12	1	BE5049M6L
M8	75 mm	22,12	1	BE5049M8L
M10	75 mm	22,12	1	BE5049M10L
M12	75 mm	29,69	1	BE5049M12L

Série Longa 75mm



Conjunto de bits de 49 peças com bits TORX regulares



BE5049t

		€		
55 x 190 x 320 mm	3.54 kg	114,46	1	BE5049T

Bits TORX®, 10mm. Série Longa 75mm

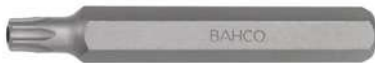

BE5049T_HL

		€		
TR20	75 mm	22,12	1	BE5049T20HL
TR25	75 mm	22,12	1	BE5049T25HL
TR27	75 mm	22,12	1	BE5049T27HL
TR30	75 mm	22,12	1	BE5049T30HL
TR40	75 mm	22,12	1	BE5049T40HL
TR45	75 mm	22,12	1	BE5049T45HL
TR50	75 mm	22,12	1	BE5049T50HL
TR55	75 mm	22,12	1	BE5049T55HL
TR60	75 mm	32,34	1	BE5049T60HL
TR70	100 mm	32,34	1	BE5049T70HL
TR80	70 mm	32,34	1	BE5049T80HL
TR30	200 mm	22,22	1	BE5049T30HXL
TR40	200 mm	22,22	1	BE5049T40HXL
TR45	200 mm	22,22	1	BE5049T45HXL

Série Longa 75mm

Bits para parafusos TORX®, 10mm. serie longa 75mm

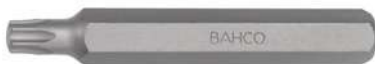

BE5049T_L

		€		
T20	75 mm	21,60	1	BE5049T20L
T25	75 mm	21,60	1	BE5049T25L
T27	75 mm	21,60	1	BE5049T27L
T30	75 mm	21,60	1	BE5049T30L

		€		
T40	75 mm	21,60	1	BE5049T40L
T45	75 mm	21,60	1	BE5049T45L
T50	75 mm	21,60	1	BE5049T50L
T55	75 mm	21,60	1	BE5049T55L
T55	115 mm	11,85	1	BE5032T55EL

serie longa 75mm

FERRAMENTAS PARA ESCAPES

Extractor de fumo de escape
Mangueira estendida de 3 metros
BUCPE3SH e mangueira para escape de
ponteira dupla BUCPE3SDH



BUCPE

		€		
5000 mm	1263 x 306 x 300 mm	754,01	1	BUCPE
105 mm	15 x 105 x 105 mm	6,74	1	BUCPEF1
121 mm	60 x 121 x 121 mm	77,90	1	BUCPEF

Extensão de tubo para BUCPE



BUCPE3SH

		€		
3000 mm	63,5 mm	200,03	1	BUCPE3SH

Um tubo de escape duplo para BUCPE



BUCPE3SDH

		€		
420 x 530 x 3000 mm	3000 mm	203,66	1	BUCPE3SDH

Chave de caixa para sonda Lambda



7812

		€		
22 mm	78 mm	13,53	100	7812

Alicate para escapes. Comprimento: 300mm



BUC50

		€		
65 mm	305 mm	64,63	1	BUC50

Comprimento: 300mm

Ferramenta universal para remover escapes



BUC110

		€		
360 mm	50 x 65 x 360 mm	46,46	1	BUC110

Removedor de filtros de óleo e combustível



BE60FW

		€		
57-120 mm	18 x 95 x 325 mm	60,95	5	BE60FW

Chave de corrente para filtro de óleo



BE64520/BE64350

		€		
350 mm	60-105 mm	53,18	1	BE64350
350 mm	60-105 mm	39,72	1	BE64350CH
520 mm	60-160 mm	63,29	1	BE64520
520 mm	60-160 mm	50,02	1	BE64520CH

Separador secções escapes



BUC100

		€		
34-54 mm	320 mm	100,99	1	BUC100

Chave de fita para filtro de óleo



BE611

		€		
65-105 mm	25 x 55 x 210 mm	35,59	12	BE61110
65-105 mm	1 x 12 x 382 mm	5,93	100	BE61110-1
100-155 mm	37 x 75 x 275 mm	38,48	12	BE61155
100-155 mm	1 x 12 x 529 mm	7,70	1	BE61155-1

Chave universal com fita de borracha



BE66152A

		€		
150 mm	95 x 170 x 220 mm	21,77	6	BE66152A

FERRAMENTAS E EQUIPAMENTOS PARA MUDANÇAS DE ÓLEO

Chave de tampa de filtro de combustível



BE60F108

		€		
3/8 in	108 mm	33,79	50	BE60F108

Chave de correia de filtro de óleo com cabo de borracha



BE62

		€		
65-105 mm	42.5 x 57 x 249 mm	38,18	10	BE62110
110-155 mm	42.5 x 85 x 314 mm	41,41	10	BE62155

Chave de Filtros 3 garras. Quadrado 3/8" + adaptador 3/8" para 1/2"



BE65F65120

		€		
3/8 in	65-120 mm	14,82	12	BE65F65120

Quadrado 3/8" + adaptador 3/8" para 1/2"



Chave filtro óleo margética 3 garras.
Quadrado 3/8" + adaptador 3/8" para 1/2"



BE65R

Quadrado	Adaptador	€	Carro	Peixe	Partes
3/8-1/2 in	65-120 mm	29,62	1		BE65R65120
3/8-1/2 in	80-119 mm	113,10	1		BE65R80120
1/2 in	105-160 mm	131,95	1		BE65R106160

Quadrado 3/8" + adaptador 3/8" para 1/2"

Conjunto copos remoção filtros óleo, 30 un.. 28 copos, 1 adaptador 1/2"-3/8" e 1 chave 3 pernas.



BE630

Dimensões	€	Carro	Peixe	Partes
87 x 505 x 610 mm	185,81	3		BE630

Copo de filtro individual



BE630 Parts

Diâmetro	Carro	€	Carro	Peixe	Partes
66 mm	Fiat, Renault	13,46	1		BE630666F
64 mm	Daihatsu, Fiat, Nissan, Toyota	13,46	12		BE6306514F
65-66 mm	Daihatsu, Toyota	13,46	12		BE630656714F
66 mm	Ford, Mazda, Subaru	13,46	1		BE6306814F

Diâmetro	Carro	€	Carro	Peixe	Partes
73 mm	Alfa Romeo, Lexus, Toyota	13,46	1		BE6307314F
74 mm	Audi, Chrysler, GM, Rover	13,46	1		BE6307415F
74-76 mm	Audi, Ford, Mercedes Benz, Opel, VW	13,46	12		BE630747615F
74-75 mm	Audi, Ford, Isuzu, Mercedes Benz, Opel, VW	13,46	1		BE630757715F
76 mm	Fiat, Mercedes Benz, Renault	13,46	12		BE6307612F
74 mm	Audi, BMW, Mercedes Benz, Opel, Porsche, VW	13,46	12		BE6307614F
74 mm	Ford	13,46	1		BE6307630F
74 mm	Fiat, Lancia	13,46	1		BE630768F
78 mm	Ford, Honda, Nissan, Toyota	13,46	12		BE6307815F
80 mm	Honda, Isuzu, Mazda, Nissan, Opel, Subaru, Toyota	13,46	1		BE6308015F
80-82 mm	Acura, Honda, Mazda, Nissan, Subaru, Toyota	13,46	1		BE630808215F
86 mm	Volvo	13,46	1		BE6308616F
86 mm	Audi, Citroen, Peugeot, Renault, VW	13,46	1		BE6308618F
89 mm	Honda, Isuzu, Mitsubishi	13,46	12		BE6309015F
92 mm	Fiat, Lancia	13,46	1		BE6309210F
92 mm	Audi, Ford, Honda, Mazda, Mitsubishi, Nissan, Opel, Porsche, Renault, Volvo, VW	13,46	1		BE6309315F
93 mm	Ford	13,46	1		BE6309336F
93 mm	Audi, VW	13,46	1		BE6309345F
95 mm	Alfa Romeo, Chrysler, Ford, Toyota	13,46	1		BE6309515F
96 mm	Audi, Renault, VW	13,46	1		BE6309618F
101 mm	Isuzu, Mitsubishi	13,46	25		BE63010015F
24 mm	BMW	26,00	50		BE630246F
106 mm	Fiat, MAN, Scania	13,46	1		BE63010615F
27 mm	Mercedes Benz	26,00	50		BE630276F
107 mm	Volvo	13,46	1		BE63010815F
32 mm	GM, Mercedes Benz, Opel, Saab	26,00	50		BE630326F
108 mm	Renault	13,46	1		BE63010818F
36 mm	BMW, Ford, Mercedes Benz, Opel, Rover, VW	26,00	100		BE630366F
38 mm	BMW, Opel, Volvo	26,00	50		BE630386F
66.5 mm	Daihatsu, Toyota	26,00	25		BE63066514F

Chave para o filtro de óleo de 27 mm para Ford e Grupo PSA



BE6302712F

Diâmetro	Adaptador	€	Carro	Peixe	Partes
1/2 in	27 mm	22,65	5		BE6302712F

Chave p/filtro óleo Toyota, Lexus, Subaru, Daihatsu de 4 cilindros (1,8 a 2,0 l)



BE63064514F1

Carro	Diâmetro	€	Carro	Peixe	Partes
Toyota, Lexus, Subaru, Daihatsu 4 cylinders (1.8-2.0 l)	64.5 mm	23,56	1		BE63064514F1

Chave p/filtro óleo Toyota, Lexus, Subaru, Daihatsu de 4, 6 ou 8 cilindros (2,5 a 5,7 l)



BE63064514F2

Diâmetro	Carro	€	Carro	Peixe	Partes
64.5 mm	Toyota, Lexus, Subaru, Daihatsu 4, 6, 8 cilindros (2.5-5.7L)	24,10	1		BE63064514F2

COPO DO FILTRO DE ÓLEO 74 mm 14 CANAIS



BE6307414F

		€		
14	1	19,41	10	BE6307414F

Jogo chaves para tampão do cárter



BE6217

	€		
55 x 105 x 220 mm	82,14	1	BE6217

Conjunto de restauro de boião de óleo



BOD10P64

	€		
68 x 225 x 280 mm	133,31	8	BOD10P64

Chaves para cárter



BE68

		€		
8 in	265 mm	31,40	12	BE6810Z
8 in	235 mm	6,58	1	BE68
8 x 10 mm	270 mm	13,33	1	BE6810

Chave de caixa 3/8" para tampão de óleo



BE621701-BE621717

	mm	€		
6	8 mm	6,42	1	BE621701
6	9 mm	6,42	1	BE621702
6	10 mm	6,42	1	BE621703
6	12 mm	6,42	1	BE621704
6	13 mm	6,42	1	BE621705
6	14 mm	6,42	1	BE621706
6	17 mm	6,42	1	BE621707
4	8 mm	6,42	1	BE621708
4	9.5 mm	6,42	1	BE621709
4	10 mm	6,42	1	BE621710
4	10.5 mm	6,42	1	BE621711
4	11 mm	6,42	1	BE621712
4	12 mm	6,42	1	BE621713
4	13.1 mm	6,42	1	BE621714
4	10 mm	6,42	1	BE621715
3	10 mm	14,09	1	BE621716
xZN	M16 mm	14,09	1	BE621717

Conjunto mini de restauro de bujão de óleo



BOD10

	€		
34 x 93 x 105 mm	51,66	1	BOD101
35 x 95 x 105 mm	54,63	1	BOD102
33 x 93 x 105 mm	54,63	1	BOD103
33 x 93 x 105 mm	59,05	1	BOD104
33 x 93 x 105 mm	62,00	1	BOD105
95 x 105 x 35 mm	67,18	1	BOD106

Extrator de bujão óleo 1/4" p/motor VAG 2 l e 4 cilindros



BE6701VAG

		€		
10 x 50 x 125 mm	0.02 kg	24,24	1	BE6701VAG

Conjunto de anilhas e bujões de drenagem do óleo



BOD10XNWS

	€		
M13x1.25	38,51	1	BOD101NWS
M13x1.5	42,90	1	BOD102NWS
M15x1.5	38,51	1	BOD103NWS
M17x1.5	42,43	1	BOD104NWS
M20x1.5	42,43	1	BOD105NWS
M22x1.5	56,83	1	BOD106NWS



Drenador de óleo 2 em 1 com capacidade de depósito de 90L com câmara de inspeção



BOD8903A

 €  
1700 x 419 x 608 mm 801,14 1 BOD8903A

Aspirador de óleo



BOD8902

  kg €  
1000 x 413 x 632 mm 38 kg 713,62 1 BOD8902

Escorredor de óleo por gravidade



BOD8901

  kg €  
1000 x 413 x 630 mm 32 kg 552,04 1 BOD8901

Extensão de funil



BOD8901AC1

 €  
620 x 620 x 150 mm 89,04 1 BOD8901AC1

Abastecedor de óleo de transmissão automática



BOD6080P12

 €  
595 x 255 x 330 mm 437,61 1 BOD6080P12

Adaptador para conjunto BOD6080P12



BOD6080P12-01

 g €  
35 g 20,33 1 BOD6080P12-01

Adaptador para conjunto BOD6080P12



BOD6080P12-02

 g €  
55 g 26,14 1 BOD6080P12-02

Adaptador para conjunto BOD6080P12



BOD6080P12-03

 g €  
45 g 26,14 1 BOD6080P12-03

Adaptador para conjunto BOD6080P12



BOD6080P12-04

 g €  
6 g 26,14 1 BOD6080P12-04

Adaptador para conjunto BOD6080P12



BOD6080P12-05

	€		
25 g	20,33	1	BOD6080P12-05

Adaptador para conjunto BOD6080P12



BOD6080P12-06

	€		
25 g	24,17	1	BOD6080P12-06

Adaptador para conjunto BOD6080P12



BOD6080P12-07

	€		
45 g	21,16	1	BOD6080P12-07

Adaptador para conjunto BOD6080P12



BOD6080P12-08

	€		
45 g	24,17	1	BOD6080P12-08

Adaptador para conjunto BOD6080P12



BOD6080P12-09

	€		
15 g	20,33	1	BOD6080P12-09

Adaptador para conjunto BOD6080P12



BOD6080P12-10

	€		
85 g	28,12	1	BOD6080P12-10

Adaptador para conjunto BOD6080P12



BOD6080P12-11

	€		
105 g	24,17	1	BOD6080P12-11

Lata de óleo



BOD4200/BOD4500

		€		
0.2l	158 x 86 x 128 mm	9,83	1	BOD4200
0.5l	158 x 86 x 128 mm	11,98	1	BOD4500

Funil óleo. 1.2 l



BOD301200

	€		
225 x 165 x 165 mm	28,28	1	BOD301200

1.2l

Tanque recolha óleo usado. 8 L



BOD2008

		€		
8 l	115 x 325 x 590 mm	45,10	1	BOD2008

8 L

Deposito óleo. 16 L



BOD1016

		€		
16l	170 x 450 x 570 mm	39,06	1	BOD1016

16 L



P/rosca tampão óleo danificada
sobredimensionada, e depois ajustar novo
bujão de drenagem e anilha



BOD10XT

L		€		
92 mm	M13x1.25	18,43	1	BOD101T
70 mm	M13x1.5	22,96	1	BOD102T
70 mm	M15x1.5	18,43	1	BOD103T
70 mm	M17x1.5	23,71	1	BOD104T
70 mm	M20x1.5	26,12	1	BOD105T
70 mm	M22x1.5	22,33	1	BOD106T

Pompa a cilindro a leva per 50-205 l,
filetatura 1/2" e 2". 300 ml/golpe



BOD60

	€		
875 x 57 x 245 mm	52,52	1	BOD60

300 ml/golpe

Mangueiras flexíveis para lubrificante



BOD54-1 / -2

		€		
4.1 mm	10.8 mm	11,37	1	BOD54-1
4.1 mm	10.8 mm	13,57	1	BOD54-2

Lata de 2 L com bico flexível



BOD2FS

		€		
21	330 x 130 x 380 mm	15,40	20	BOD2FS

Bomba de Lubrificação Profissional



BOD5HD400

	€		
60 x 115 x 360 mm	55,15	1	BOD5HD400

Recepte para lubrificante



BOD54-3

L	€		
37 mm	9,14	1	BOD54-3

Bomba manual para a transferência
contínua. Capacidade: 250ml/min



BOD70

	€		
230 x 250 x 1330 mm	152,51	1	BOD70

Capacidade: 250ml/min

Pistola de Lubrificação



BOD5400/BOD5450

	€		
55 x 120 x 390 mm	35,72	1	BOD5400
65 x 125 x 385 mm	59,35	1	BOD5450

FERRAMENTAS E EQUIPAMENTOS PARA O SISTEMA DE TRÁVAGEM

Caneta para comprovar líquido dos
travões



BBR100

	€		
20 x 20 x 150 mm	47,13	1	BBR100

Comprovador humidade liquido dos travões. DOT 3/4/5/5.1



BBR110

	€		
35 x 65 x 160 mm	100,99	1	BBR110

DOT 3/4/5/5.1

Chaves para casquilho de purga do travão



BBR501011-BBR50121314

		€		
10 / 11 mm	3/8 in	72,04	50	BBR501011
12 / 14 mm	3/8 in	72,04	50	BBR50121314

Purgador de travões pneumático



BBR350

		€		
1/4" in	300 x 125 x 125 mm	200,63	1	BBR350

Purgador de travões elétrico de 12 V



BBRBB12

		€		
895 x 390 x 395 mm	14.6 kg	1.714,82	1	BBRBB12

Kit adaptador da tampa do cilindro principal de purga do travão



BBRAS14

		€		
PN5 in	85 x 350 x 445 mm	291,19	4	BBRAS14

Kit adaptador da tampa do cilindro principal de purga do travão



BBRAS14-01/BBRAS14-14

		€		
PN5 in	Universal	53,95	1	BBRAS14-01
PN5 in	Honda	26,00	1	BBRAS14-02
PN5 in	Honda Accord	23,12	1	BBRAS14-03
PN5 in	Universal	34,65	1	BBRAS14-04
PN5 in	Chrysler, Jeep, Plymouth	7,71	1	BBRAS14-05
PN5 in	Chrysler, Jeep, Plymouth, Dodge	8,67	1	BBRAS14-06
PN5 in	Nissan	12,53	1	BBRAS14-07
PN5 in	Alfa Romeo, Fiat, Peugeot, Citroën, Audi, BMW, Jaguar, Land-Rover, Mercedes, Porsche, Renault, Saab, VW, Volvo, Chrysler, Daewoo, Ford, Kia, Mazda, Mini, etc	14,24	1	BBRAS14-08
PN5 in	Hyundai, Mitsubishi, Nissan, Subaru, Chrysler, Dodge, Ford, etc.	14,81	1	BBRAS14-09
PN5 in	GM Models and Mazda	12,07	1	BBRAS14-10
PN5 in	Toyota and Lexus	65,93	1	BBRAS14-11
N/A in	Holder for universal adaptor	9,52	1	BBRAS14-12
N/A in	Syringe	21,60	1	BBRAS14-13
N/A in	Hooks, chains and roulettes for BBRAS14-01 and BBRAS14-04	10,59	1	BBRAS14-14

Medidor de espessura da pastilha de travão



BBRPTG1

	€		
68 g	20,58	10	BBRPTG1



Micrómetro de base magnética



1154

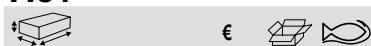

230 x 50 x 75 mm € 141,47 1 1154

1154-DG

1154-MB

Paquímetro de alumínio

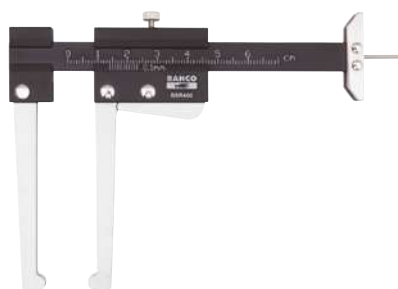

BBR400



6 x 89 x 120 mm € 37,70 1 BBR400

Calibrador de travão digital

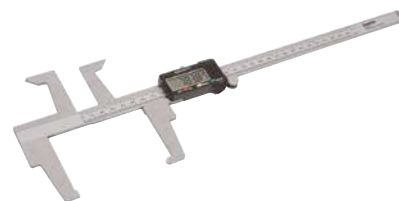

BBR405

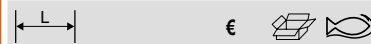

460 mm € 197,78 20 BBR405

Manómetro digital



1154-DG



0-10 mm 0.01 mm € 77,10 1 1154-DG

Calibrador digital para discos de travão



BBR420

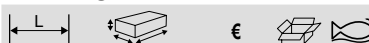

0-60 mm 35 x 104 x 176 mm € 85,42 50 BBR420

Escova metálica com cabo de fibra



783



223 mm € 13,58 1 783

Suporte magnético articulado



1154-MB

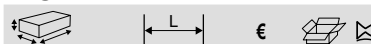

70 x 96 x 297 mm 230 + 150 mm € 57,17 1 1154-MB

Paquí. p/medir disco travão e o diâm. sapata travão



BBR410



20 x 210 x 280 mm 0.610 kg € 51,15 24 BBR410

Reposicionador pneumático para pistões de travões



BBR320

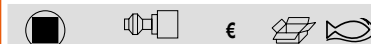

3/8 in 1/4" in € 100,31 1 BBR320

Conj. 50 peças de ferramenta calibradora de travão universal



BBR300P50

		€		
82 x 350 x 425 mm	5.56 kg	263,90	4	BBR300P50

Chaves impacto 1/2' com bits TX para travões. 9 peças



BBR203P9

	€		
68 x 225 x 225 mm	116,63	1	BBR203P9

9 peças

BBR203P925, BBR203P960,
BBR203P930, BBR203P927,
BBR203P920, BBR203P945,
BBR203P955, BBR203P940,
BBR203P950

Chaves impacto 1/2' com bits TX para travões



BBR203P920-BBR203P960

	€		
T20 78 mm	15,47	1	BBR203P920
T25 78 mm	15,47	1	BBR203P925
T27 78 mm	15,47	1	BBR203P927

	€		
T30 78 mm	15,47	1	BBR203P930
T40 78 mm	15,47	1	BBR203P940
T45 78 mm	15,47	1	BBR203P945
T50 78 mm	15,47	1	BBR203P950
T55 78 mm	16,38	1	BBR203P955
T60 78 mm	16,38	1	BBR203P960

Conjunto de chaves impacto de 1/2' com bits XZN para travões. 6 peças



BBR201P6

	€		
68 x 225 x 225 mm	81,19	8	BBR201P6

6 peças

BBR201P67814, BBR201P67816,
BBR201P67818, BBR201P64018,
BBR201P64014, BBR201P64016

Chaves impacto 1/2' com bits ZZN



BBR201P64014-BBR201P67818

	€		
M14 40 mm	8,32	1	BBR201P64014
M16 40 mm	8,32	1	BBR201P64016
M18 40 mm	8,55	1	BBR201P64018
M14 78 mm	9,58	1	BBR201P67814
M16 78 mm	9,58	1	BBR201P67816
M18 78 mm	10,47	1	BBR201P67818

Conjunto de chave de caixa 1/2' e bits para travão de mão



BBR202P4

	€		
43 x 90 x 200 mm	45,76	1	BBR202P4
	6,80	1	BBR202P410
	6,80	1	BBR202P414
	8,32	1	BBR202P419
	8,32	1	BBR202P455

Molas de remoção e instalação de calços de travões



BBR210P3

	€		
80 x 270 x 375 mm	155,02	1	BBR210P3
25 x 59 x 182 mm	99,37	1	BBRS210P
75 x 270 x 350 mm	113,58	1	BBRS210P2

Alicate de remoção de molas dos travões



BBR6135

	€		
335 mm	65,98	1	BBR6135



Alicate removedor de molas dos travões



BBR6131

	€		
210 mm	32,88	1	BBR6131

Alicate para cabos de travão de mão



BBR204

		€		
235 mm	21,9 mm	34,84	6	BBR204

Braçadeiras para o circuito de travagem



BBR150i

		€		
13,5 mm	10 x 52 x 165 mm	17,29	24	BBR150i

Kit de dilatação



BBRFKM1

		€		
141 x 115 x 195 mm	1551 g	187,66	12	BBRFKM1

FERRAMENTAS PARA DIREÇÃO E JANTES

Chave Estrela para rodas



29-B/BWXW1/BWXW2

S		€		
17,19,21 mm	1/2 in	32,32	1	29-B
17,19,22 mm	1/2 in	35,01	1	BWXW1
24,27,32 mm	3/4 in	105,02	1	BWXW2
17, 19, 21, 22 mm		32,32	1	BWXW3
24, 27, 32, 38 mm		109,08	1	BWXW4

Chave de caixa protegidas para rodas.
BWSS12P5: 17, 19, 21, 22, 24 mm



BWSS12P3

		€		
17, 19, 21 mm	45 x 125 x 145 mm	40,26	20	BWSS12P3

BWSS12P5: 17, 19, 21, 22, 24 mm

BWSS12P317, BWSS12P319, BWS-
S12P321

Jogo de chaves de caixa para roda.
Conteúdo: 17, 19, 21, 22, 24 mm



BWSS12P5

		€		
17, 19, 21, 22, 24 mm	175 x 240 x 50 mm	61,94	1	BWSS12P5

Conteúdo: 17, 19, 21, 22, 24 mm

BWSS12P319, BWSS12P317,
BWSS12P524, BWSS12P522, BWS-
S12P321

Chaves de caixa para roda



BWSS12P

		€		
1/2 in	17 mm	13,33	1	BWSS12P317
1/2 in	19 mm	14,15	1	BWSS12P319
1/2 in	21 mm	14,15	1	BWSS12P321
1/2 in	22 mm	16,15	1	BWSS12P522
1/2 in	24 mm	16,15	1	BWSS12P524

Chave de impacto para rodas de 15 mm



BWSMB15

	€		
15 mm	14,46	25	BWSMB15

Chave impacto 17 mm p/roca de rodas antirroubo da Mercedes



BWSMB17

	€		
17 mm	16,15	1	BWSMB17

Chave de impacto para rodas de longo alcance de 1/2"



BWSS12PL

		€		
1/2 in	17 mm	23,97	1	BWSS12P317L
1/2 in	19 mm	24,10	1	BWSS12P319L
1/2 in	21 mm	24,24	1	BWSS12P321L

Conjunto de 6 peças para roquete Deep Twist



BWTSP6

	€		
55 x 105 x 217 mm	94,54	1	BWTSP6

Chave de impacto antirroubo de 21 mm para Hyundai e KIA



BWSHK21

		€		
1/2" in	21 mm	16,83	25	BWSHK21

Conj. chaves caixa de torção longas de 1/2", 17, 19 e 21 mm



BWTSP3L

	€		
68 x 225 x 150 mm	132,62	1	BWTSP3L

BWTSP619, BWTSP617, BWTSP622, BWTSP621, BWTSP624

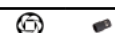

Peça para roquete Deep Twist



BWTSP617-BWTSP624

		€		
17 mm	1/2 in	18,93	1	BWTSP617
19 mm	1/2 in	18,93	1	BWTSP619
21 mm	1/2 in	18,93	1	BWTSP621
22 mm	1/2 in	19,65	1	BWTSP622
24 mm	1/2 in	19,65	1	BWTSP624

Conj. chaves de impacto p/rodas longo alcance 17, 19 e 21 mm



BWSS12P3L

		€		
17, 19, 21 mm	68 x 225 x 225 mm	97,06	1	BWSS12P3L

Chave caixa de torção longa de 1/2" c/150 mm de comprimento



BWTSP317L-BWTSP321L

		€		
1/2 in	17 mm	40,33	1	BWTSP317L
1/2 in	19 mm	43,76	1	BWTSP319L
1/2 in	21 mm	47,46	1	BWTSP321L

Jogo de chaves de caixa



BWTSP7

	€		
52 x 117 x 207 mm	266,34	1	BWTSP7

1/2": 22, 24, 27, 32 mm & 3/4": 36, 41 mm

BWSS12P317L, BWSS12P319L, BWSS12P321L



Chaves de caixa para rodas



BWTSP16

Icon	€	Icon	Icon
48 x 125 x 245 mm	291,59	1	BWTSP16

3/8": 8, 10, 11, 12, 13, 14, 16, 17, 18, 19 mm & 1/2": 21, 22, 24, 27 mm

Chave de caixa para rodas



BWTSP

Icon	Icon	€	Icon	Icon
8 mm	3/8 in	24,20	1	BWTSP1608
10 mm	3/8 in	15,27	1	BWTSP1610
11 mm	3/8 in	15,27	1	BWTSP1611
12 mm	3/8 in	15,27	1	BWTSP1612
13 mm	3/8 in	15,27	1	BWTSP1613
14 mm	3/8 in	15,27	1	BWTSP1614
16 mm	3/8 in	16,36	1	BWTSP1616
17 mm	3/8 in	16,36	1	BWTSP1617
18 mm	3/8 in	16,36	1	BWTSP1618
19 mm	3/8 in	16,36	1	BWTSP1619
21 mm	1/2 in	31,90	1	BWTSP1621
22 mm	1/2 in	32,24	1	BWTSP1622
24 mm	1/2 in	32,99	1	BWTSP1624
27 mm	1/2 in	33,62	1	BWTSP1627
32 mm	1/2 in	78,12	1	BWTSP732
36 mm	3/4 in	92,72	1	BWTSP736
41 mm	3/4 in	107,99	1	BWTSP741

Conj. 5 barras torção c/encaixe de 1/2", p/apertar porcas de rodas com pistola de impacto sem exceder o torque recomendado



BWTB12P5

Icon	kg	€	Icon	Icon
68 x 225 x 280 mm	1.74 kg	119,84	1	BWTB12P5

BWTB12P90, BWTB12P100, BWTB12P110, BWTB12P120, BWTB12P135

Barra torção c/encaixe de 1/2", p/apertar porcas de rodas com pistola de impacto sem exceder o torque recomendado



BWTBP1290-BWTB12P200

Icon	Nm	€	Icon	Icon
200 mm	100 N-m	23,56	1	BWTB12P100
200 mm	110 N-m	23,56	1	BWTB12P110
200 mm	120 N-m	23,56	1	BWTB12P120
200 mm	135 N-m	23,56	1	BWTB12P135
200 mm	150 N-m	23,56	1	BWTB12P150
200 mm	160 N-m	23,56	1	BWTB12P160
200 mm	175 N-m	23,56	1	BWTB12P175
200 mm	190 N-m	23,56	1	BWTB12P190
200 mm	200 N-m	23,56	1	BWTB12P200
200 mm	90 N-m	23,56	1	BWTB12P90

Barra de torsão Impacto 1"



BZWTB

Icon	MAX	€	Icon	Icon
32 mm	450 N-m	176,49	1	BZWTB0132450
32 mm	600 N-m	176,49	1	BZWTB0132600

Saco de parafusos para roda



BWBB

kg	Icon	€	Icon	Icon
0.023 kg	180 x 1 x 300 mm	8,41	200	BWBB

Conjunto de fresas de rosca



BWHTRS12

Icon	g	€	Icon	Icon
225 x 67 x 225 mm	1350 g	220,01	15	BWHTRS12

Saca pneus



38-8 - 38-24

↔ L ↔	€	📦	🐟
200 mm	16,15	5	38-8
300 mm	20,20	5	38-12
400 mm	25,59	5	38-16
500 mm	32,32	2	38-20
600 mm	40,39	1	38-24

Desmontas para pneus



38A

↔ L ↔	€	📦	🐟
200 mm	6,45	25	38A-08
240 mm	7,13	25	38A-10
304 mm	8,08	1	38A-12
382 mm	9,43	25	38A-15
537 mm	18,86	1	38A-21
655 mm	21,54	1	38A-26

Desmonta pneus para veículos comerciais e camiões



38C

↔ L ↔	€	📦	🐟
645 mm	24,24	1	38C-26

Saca pneus



39-24

↔ L ↔	€	📦	🐟
605 mm	26,95	1	39-24

Calços



BWC1

📦	€	📦	🐟
75 x 77 x 110 mm	17,25	25	BWC1

Alicate para pesos de equilibrio das rodas



BWP150

📦	€	📦	🐟
20 x 87 x 255 mm	24,24	1	BWP150

Medidor digital de profundidade do piso dos pneus



BWTDG1

↔ L ↔	📦	€	📦	🐟
0 - 25 mm	30 x 76 x 156 mm	38,18	50	BWTDG1

Calibrador de pressão de pneus



BWTPG1

📦	€	📦	🐟
20 x 90 x 394 mm	53,32	10	BWTPG1

Conj. ferr. man. p/sistema monit. pressão dos pneus



BWTPMSS9

📦	g	€	📦	🐟
68 x 225 x 225 mm	1049 g	321,80	8	BWTPMSS9



Ferr. p/núcleo da válvula do pneu c/binário máx. 0,45 Nm



BWTVCTT355

		€		
0.45 N·m	0.33 lbf·ft	28,13	1	BWTVCTT355

Chave impacto 1/2" de 12 faces



BT15P524-BT15P536

		€		
1/2 in	24 mm	12,61	1	BT15P524
1/2 in	30 mm	15,16	1	BT15P530
1/2 in	32 mm	16,32	1	BT15P532
1/2 in	36 mm	21,76	1	BT15P536

Chave de impacto 1" Camiões. BPW



BHVISxxBPW

		€		
3/4 in	111 mm	216,79	1	BHVIS111BPW12
3/4 in	80 mm	153,49	1	BHVIS80BPW12
3/4 in	95 mm	158,88	1	BHVIS95BPW9

Tampas de esvaziamento da válvula do pneu



BWTPMSS4C

		€		
27 x 59 x 108 mm	60 g	34,34	25	BWTPMSS4C

Chave de impacto 3/4" camiões. Scania



BHVIS08

		€		
3/4 in	95 mm	175,04	1	BHVIS0895
3/4 in	100 mm	193,21	1	BHVIS08100
3/4 in	115 mm	197,53	1	BHVIS08115
	109 mm	206,96	1	BHVIS109BPW12
	120 mm	240,34	1	BHVIS120BPW16

Scania

BPW

Cubo de roda com martelo corredeiro & fuso hidráulico



BWHEPSSH8

		€		
12 to	#4-5/116-135 mm	968,25	1	BWHEPSSH8

Chave impacto 1/2" e conjunto de bits



BT15P5

	€		
60 x 85 x 255 mm	81,19	1	BT15P5

Chave de impacto 1" paredes finas



BHVIS12 / BHVIS06

		€		
12	68 mm	86,16	1	BHVIS1265
6	70 mm	97,62	1	BHVIS0670
6	77 mm	129,26	1	BHVIS0677
6	80 mm	137,34	1	BHVIS0680
6	85 mm	201,97	1	BHVIS0685
6	90 mm	214,08	1	BHVIS0690
6	95 mm	336,61	1	BHVIS0695
6	100 mm	504,93	1	BHVIS06100
6	105 mm	572,24	1	BHVIS06105

Cubo de roda hidráulico



BWHEPS

		€		
12 to	#4-5 / 116-135 mm	457,51	1	BWHEPS

BWHEP

BWHEHS



Conjunto de cubo de roda e martelo corredeiro



BWHEPSH8

		€		
#4-5 / 116-135 mm	960 x 150 x 150 mm	598,30	1	BWHEPSH8

Martelo deslizante de 5Kg



BWSH5

	€		
100 x 100 x 985 mm	342,91	2	BWSH5

Adaptador M18



BWSH51

		€		
M38 mm	M18x38	18,31	1	BWSH51

Placa para martelo deslizante



BWHEP

		€		
#4-5 / 116-135 mm	90 x 147 x 147 mm	235,77	1	BWHEP

Martelo deslizante de 8Kg



BWSH8

	€		
960 x 100 x 100 mm	444,37	1	BWSH8

Caixa ferr. remoção tirante interior de alavanca de direção



BS5228-BS523945

	€		
28-34 mm	88,86	1	BS5228341
34-40 mm	88,86	1	BS5234401
39-35 mm	88,86	1	BS5239451

Extrator hidraulico de 12 Toneladas



BWHEHS

		€		
12 to	265-282 mm	245,76	1	BWHEHS

Peso de 3,5Kg



BSSHE3

		€		
60 mm	100 mm	101,46	1	BSSHE3

Fivela e cinta em aço inoxidável de 5mm 15m de cintas e 50 fivelas



BE2512005

		€		
5 mm	12 m	78,10	1	BE2512005



Alicate em aço inoxidável para fivela



BE251200

	€		
170 mm	99,64	1	BE251200

Conj. ferr. remoção tirante interno de alavanca de direção



BS52

		€		
110 x 315 x 380 mm	3.08 kg	249,09	1	BS52

Bocal excêntrico para eixo traseiro



BS45BMW

		€		
1/2 in	40 x 43 x 43 mm	35,53	20	BS45BMW

Ferramenta pneumática de instalação de folie de transmissão



BPCVB1

		€		
25-110 mm	138 x 138 x 455 mm	226,49	6	BPCVB1

33-42 mm



BS54

	€		
57 x 57 x 70 mm	64,63	1	BS54

Ferramenta de ajuste do ângulo de sopé



BS40VAG

		€		
22 mm	52 x 92 x 150 mm	63,95	20	BS40VAG

Fivela e cinta em aço inoxidável de 8mm
15m de cintas e 50 fivelas



BE2512008

		€		
8 mm	15 m	83,48	1	BE2512008

Extrator da cabeça da barra de direção



BS56

		€		
1/2 in	57 x 57 x 57 mm	35,25	6	BS56

Jogo para rolamentos de rodas



BWB14

	€		
80 x 300 x 525 mm	484,49	2	BWB14

Remoção de rolamentos e conjunto de instalação



BT20P26

	€		
150 x 310 x 535 mm	693,43	1	BT20P26

Conjunto de extrator de juntas esféricas com fuso hidráulico 12T



BWHPJ12

		€		
12 to	70 mm	304,14	4	BWHPJ12

Conjunto de ferramentas para embraiagem SAC



BE301

	€		
80 x 395 x 430 mm	456,77	2	BE301

Conjunto de remoção e instalação de rolamentos hidráulicos



BT20P49

	€		
164 x 520 x 890 mm	2.523,68	1	BT20P49

Ferramenta de junta de apoio para VW T4



4594VWT4

	€		
245 x 112 x 320 mm	355,90	5	4594VWT4

Conjunto de mandris de centragem para embraiagens SAC



BE301CM-SET

	€		
26 x 81.5 x 200 mm	62,80	50	BE301CM

BE301CM-01, BE301CM-02

Chave para desmontar barra de direcção



BS6

		€		
18 mm	400 mm	53,87	1	BS618
23 mm	400 mm	105,28	1	BS623

Saca esferas para PSA



BS100PSA1

		€		
56 mm	52 mm	101,56	1	BS100PSA1

Mandris de centragem para embraiagens SAC



BE301CM

		€		
15.19 mm	174 mm	32,35	20	BE301CM-01
20.26 mm	174 mm	32,35	20	BE301CM-02



Rectificador de alinhamento para embraiagem



BE310

		€		
68 x 225 x 280 mm	1.14 kg	80,79	8	BE310

FERRAMENTAS E EQUIPAMENTOS PARA SUSPENSÕES

Barra de alavanca para braço de suspensão



BS25

		€		
20 N·m	200 kg	227,77	1	BS25

Dispositivo compressor para molas Macpherson



BS15

	€		
125 x 425 x 510 mm	666,50	1	BS15
43 x 110 x 160 mm	77,34	1	BS15125
165 x 160 x 385 mm	6,87	1	BS15125C

	€		
42 x 160 x 160 mm	82,72	1	BS15160
42 x 160 x 170 mm	6,87	1	BS15160C
42 x 160 x 212 mm	88,15	1	BS15212
24 x 160 x 215 mm	6,87	1	BS15212C
45 x 56 x 95 mm	44,66	1	BS1550

Compressor para amortecedor de pistão pneumático duplo com grelha de proteção



BS30PG

		€		
1180 x 500 x 625 mm	24 kN	2.474,20	1	BS30PG

Compressor de molas. Tipo economico



BS10AC2

		€		
400 x 400 x 200 mm	1 kg	592,45	1	BS10AC2

Tipo economico

Extensão de altura móvel



BS30AC1

	€		
336 x 545 x 450 mm	479,34	1	BS30AC1

Jogo para amortecedores. 39 pcs para amortecedores McPherson



BS1000

	€		
70 x 405 x 575 mm	390,48	1	BS1000
	17,76	1	BS100001
	17,76	1	BS100002
	17,76	1	BS100003
	17,76	1	BS100004
	17,76	1	BS100005
	17,76	1	BS100006
	17,76	1	BS100007
	17,76	1	BS100008
	17,76	1	BS100009
	14,52	1	BS100010
	14,52	1	BS100011
	14,52	1	BS100012
	12,09	1	BS100013
	12,09	1	BS100014
	12,09	1	BS100015
	12,09	1	BS100016
	12,09	1	BS100017
	12,09	1	BS100018
	12,09	1	BS100019
	12,09	1	BS100020
	12,09	1	BS100021
	14,52	1	BS100022
	14,52	1	BS100023
	14,52	1	BS100024
	14,52	1	BS100025
	14,52	1	BS100026

€			
14,52	1	BS100027	
14,52	1	BS100028	
12,09	1	BS100029	
12,09	1	BS100030	
12,09	1	BS100031	
12,09	1	BS100032	
12,09	1	BS100033	
12,09	1	BS100034	
16,23	1	BS100035	
16,23	1	BS100036	
16,23	1	BS100037	
16,23	1	BS100038	
16,23	1	BS100039	

39 pcs para amortecedores McPherson

FERRAMENTAS PARA GESTÃO DE BATERIAS ELÉTRICAS

Detetor protetor de memórias de diagnóstico integrado



BELMS12OBDL

€			
72,34	8	BELMS12OBDL	

Booster 12 V 1200 CA



BBAGM12-1200

€			
556,20	1	BBAGM12-1200	

Booster 12 / 24 V 2400 / 1200 CA



BBAGM1224-2400

€			
1.261,75	1	BBAGM1224-2400	

Bateria de substituição para arrancadores de 12 V



BBAGMBAT

€			
380,07	1	BBAGMBAT	

Booster lader. BBC4A:ta käytetään yhdessä B12-760, BB12-1200, BB1224-760, BB1224-1200 kanssa



BBAGMCHG

€			
96,82	1	BBAGMCHG	

Cabo de carregamento de 12 V para servofreio sobresselente



BBAGMCAB

€			
20,09	1	BBAGMCAB	

ARRANCADOR POTENTE DE 12/24 V



BBA1224-3200

€			
3.336,29	1	BBA1224-3200	

ARRANCADOR HÍBRIDO DE 12 V COM CONDENSADORES



BBH12-1200

€			
908,96	1	BBH12-1200	



Cabos de bateria



BBJL

Diagram	Length (L)	Price (€)	Quantity	Model
	3 m	41,13	5	BBJL1630
	3.5 m	95,52	1	BBJL2535
	4.5 m	127,09	1	BBJL3545

Carregador/reparador automático de 10 A para baterias de 12V



BBCE12-10

V	A	€	Quantity	Model
12V	10A	145,92	2	BBCE12-10

CARREGADOR BATERIAS DE 100 A/ FONTE DE ALIMENTAÇÃO



BBCE12-F100

V	A	€	Quantity	Model
12V	4/20/70/100AA	1.406,14	1	BBCE12-F100

Carregador/reparador auto 3 A p/baterias chumbo-ácido e lítio LiFeP04 de 12 V



BBCE12-3

V	A	€	Quantity	Model
12V	3A	99,50	2	BBCE12-3

Carregador/reparador totalmente automático de 15 A. para baterias de 12 V com modo de alimentação



BBCE12-15S

V	A	€	Quantity	Model
12V	10/15A	177,30	2	BBCE12-15S

Carregador-Starter de baterias



BBC420-BBC620

V	Capacity	Price (€)	Quantity	Model
230 V	20/1000 A-h	583,69	1	BBC420
230 V	20/1550 A-h	835,73	1	BBC620

Carregador/reparador automático de 6 A para baterias de 12 V



BBCE12-6

V	A	€	Quantity	Model
12V	6A	119,39	2	BBCE12-6

Carregador/reparador automático de 10 A para baterias de 24V



BBCE24-10

V	A	€	Quantity	Model
24V	10A	198,99	2	BBCE24-10

Comprovador do ácido das baterias



BB10

Dimensions	Price (€)	Quantity	Model
50 x 50 x 285 mm	12,18	1	BB10

Comprovador de baterias digital 12V



BBT20

90 x 160 x 345 mm € 98,17 1 BBT20

Multímetro digital, auto, True RMS 1000 V e ligação ao PC



BMMTRMS1

155 x 60 x 225 mm 0.8 kg € 214,26 1 BMMTRMS1

Comprovador de comandos à distância



BELTKEY

35 x 63 x 160 mm € 177,73 1 BELTKEY

Verificador Digital de Baterias de 12 V



BBT60A

27 x 95 x 135 mm € 215,22 36 BBT60A

Dispositivo de teste de ausência de tensão de 1000 V, dispositivo de teste de tensão sem contacto



BMVAT1000

310 x 50 x 100 mm 0.302 kg € 135,91 50 BMVAT1000

Comprovador tomada de veículos. 7 PINOS 12V



BELT127

35 x 63 x 160 mm € 106,37 1 BELT127

COMPROVADOR DE BATERIA DIGITAL DE 6/12 V COM IMPRESSORA



BBT80

64 x 130 x 251 mm € 608,90 6 BBT80

Medidor de grampo digital True RMS 1000A CA/CC



BDACM1000

60 x 143 x 250 mm 0.551 kg € 124,65 30 BDACM1000

Verificador de velas de funcionamento das luzes do veículo de 12 V



BELT1213A

40 x 138 x 205 mm 1.726 kg € 309,74 20 BELT1213A



Verificador de velas de funcionamento das luzes do veículo de 24V



BELT2415A

40 x 138 x 205 mm 1.897 kg 360,75 20 BELT2415A

Comprovador tomada de reboque. 7 PIN 24V (24N) - Cabo 4 m



BELT247N

55 x 63 x 160 mm 115,80 1 BELT247N

7 PIN 24V (24N) - Cabo 4 m

Comprovador tomada de reboque. 7 PIN 24V (24S) - Cabo 4 m



BELT247S

35 x 63 x 155 mm 115,80 1 BELT247S

7 PIN 24V (24S) - Cabo 4 m

Ferro de soldar a gás profissional



BGIS125

25-125 W 46 x 88 x 295 mm 166,95 20 BGIS125

Jogo de Chaves para terminais.. 16 pçs



BELTRP16

58 x 215 x 265 mm 215,43 1 BELTRP16
 22,65 1 BELTRP1601
 2,15 1 BELTRP1602
 23,80 1 BELTRP1603
 2,15 1 BELTRP1604
 22,65 1 BELTRP1605
 2,15 1 BELTRP1606
 21,24 1 BELTRP1607
 22,65 1 BELTRP1608
 17,94 1 BELTRP1609
 19,87 1 BELTRP1610
 22,10 1 BELTRP1611
 23,11 1 BELTRP1612
 15,15 1 BELTRP1613
 17,92 1 BELTRP1614
 17,92 1 BELTRP1615
 17,92 1 BELTRP1616

16 pçs

Protector de memórias 12V



BELS12

35 x 63 x 160 mm 92,91 1 BELS12

Protector de picos 12/24V



BELP1224

35 x 63 x 160 mm 87,53 1 BELP1224

Grampos de bateria (ligação rápida), para carregadores BBCE612-2, BBCE12-3 e BBCE12-6



BBCEC1

68 g 9,82 1 BBCEC1

Conector anelar (ligação rápida) para carregador BBCE



BBCER1

100 g 9,95 1 BBCER1

Grampo de bateria (ligação rápida) para carregador BBCE



BBCEC2

	€		
68 g	13,21	1	BBCEC2

Conectores anelares (ligação rápida), para carregadores BBCE12-10 e BBCE24-10



BBCEC2

	€		
100 g	13,21	1	BBCEC2

Fichas ligação dos Boosters para Austrália e UK.. Austrália, Europa Continental e RU



BBCEC2

	€		
50 x 125 x 50 mm	11,82	1	BBCEC2-AUZ
50 x 125 x 50 mm	14,01	1	BBCEC2-EU
50 x 50 x 50 mm	11,82	1	BBCEC2-UK

Austrália, Europa Continental e RU

PRENSAS E ACESSÓRIOS

Prensa de bancada hidraulica



BH715

	€		
15.000 kg	1.027,43	1	BH715

Preensas hidraulicas

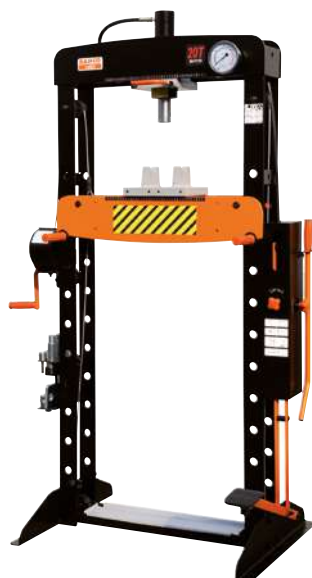

BH720/BH730/BH750

	€		
20.000 kg	1.885,18	1	BH720
30.000 kg	2.207,09	1	BH730
50.000 kg	3.242,38	1	BH750

Prensa hidraulica/pneumatica de 100 T



BH7100

	€		
100000 kg	7.713,24	1	BH7100A

Suportes para prensa universais 30 t



BH7PS30

	€		
225 x 100 x 275 mm	313,64	2	BH7PS30

Pinos de pressão para 15T



BH715-13

	€		
7.09 kg	148,10	1	BH715-13
7.09 kg	161,54	1	BH720-22



GRELHA DE SEGURANÇA



BH7 SG

530 mm	20 mm	€	1	BH720SG
590 mm	20 mm	163,99	1	BH730SG
625 mm	20 mm	177,65	1	BH750SG

Bandejas inferiores para mesa multifunções



BLEMAT1BT

50 x 760 x 890 mm	10.5 kg	€	1	BLEMAT1BT
		86,39	1	BLEMAT1BT

Prato magnético com extensão em PVC



BMD150

160 mm	€	1	BMD150
	12,78	1	BMD150

Grelha de segurança para prensa de 100 t



BH7100SG

150 x 593 x 625 mm	5.54 kg	€	1	BH7100SG
		450,68	1	BH7100SG

Conj. 4 bolsas armazenamento/proteção p/rodas e pneus



BWB1418S4/BWB1922S4

355 - 470 mm	€	6	BWB1418S4
470 - 560 mm	82,25	6	BWB1922S4

Bandeja magnética com extensão em PVC



BMR240

250 mm	€	1	BMR240
	22,90	1	BMR240

EQUIPAMENTO PARA ILUMINAÇÃO

Mesas multifunções



BLEMAT1

860 x 155 x 780 mm	28.7 kg	€	1	BLEMAT1
		435,38	1	BLEMAT1

Bandeja magnética



1419-MD

150 mm	€	1	1419-MD
	11,98	1	1419-MD

Banco de oficina pneumático almofadado



BLE305

430 x 410 x 430 mm	€	1	BLE305
	152,56	1	BLE305

Banco com armazenamento



BLE300

		€		
380 x 380 x 550 mm	136 kg	187,16	1	BLE300

Conjunto de estrado e banco



BLE304

		€		
460 x 1020 x 135 mm	116 / 100 kg	166,96	1	BLE304

Protector de Carroceria



BBS50

		€		
900 mm	1.2 mm	55,06	1	BBS50

Estrado/banco de 3 posições



BLE302

		€		
135 x 490 x 1010 mm	136 kg	123,65	1	BLE302

Cobertura de banco



5750

		€		
1390 mm		18,30	1	5750

Centra Faróis Laser Electronico



BLBT100

	€		
1650 x 500 x 565 mm	1.205,08	1	BLBT100

Estrado de perfil baixo



BLE301

		€		
120 x 590 x 1020 mm	136 kg	117,15	1	BLE301

Protector da carroçaria dianteira do veículo multiusos



5770

		€		
350 x 300 x 85 mm	990 g	73,81	12	5770

Calha para BLBT100



BLBT100AC1

		€		
150 x 150 x 1025 mm	7.77 kg	312,45	1	BLBT100AC1



Alavanca de roquete multi posições



BT10P3

	€		
80 x 270 x 375 mm	123,86	1	BT10P3

Extrator combinada multi posições



BT10P325-BT10P338

	€		
250 mm	40,92	40	BT10P325
300 mm	44,71	1	BT10P330
380 mm	51,00	1	BT10P338

Conjunto de alavanca longa



BPBLS4

		€		
78 x 255 x 1000 mm	9050 g	237,49	2	BPBLS4

BPBL00900, BPBL30900, BPBL70600, BPBL90600

Alavancas longas



BPBL

	€		
930 mm	64,39	5	BPBL00900
925 mm	64,39	5	BPBL30900
610 mm	56,62	5	BPBL70600
628 mm	57,59	5	BPBL90600

FERRAMENTAS PARA OFICINAS DE CHAPEIRO

Suporte universal com ventosas de borracha



BBS3BH1

	€		
955 mm	114,46	1	BBS3BH1

Ventosa para suporte universal



BBS3BH1-VP

	€		
60 x 95 x 95 mm	16,18	40	BBS3BH1-VP

Suporte universal de trabalho



BBS3UH

		€		
950 x 800 x 1200 mm	20 kg	462,55	1	BBS3UH

Ventosa



BBS075

		€		
160 mm	175 mm	40,52	12	BBS075

Ventosas de Chapeiro



BBS150

		€		
120 mm	400 mm	129,26	1	BBS150

Chave para limpar calhas dos vidros



BBS106

		€		
25 x 25 x 332 mm	0.145 kg	19,73	1	BBS106

Empurra fios recto



BBS103

	€		
25 x 25 x 345 mm	20,20	1	BBS103

Empurra fios em forma de T



BBS102

	€		
265 mm	12,38	1	BBS102

Manipulos para fio de remover pára-brisas



BBS101

	€		
30 x 80 x 115 mm	30,97	1	BBS101

Fio para remover pára-brisas



BBS150S

	€		
50 m	49,82	1	BBS150R
50 m	57,90	1	BBS150S
50 m	63,29	1	BBS150T

Ferramenta para corte de pára-brisas



BBS105

	€		
20 x 90 x 200 mm	40,39	1	BBS105

Faca de corte de Uretano



BBS10450

		€		
10 x 30 x 450 mm	0.240 kg	28,01	1	BBS10450

Kit de 3 Lâminas rectas



BBS107

	€		
1 x 18 x 125 mm	10,72	1	BBS107

Kit de 3 Lâminas em forma de L



BBS108

	€		
20 x 19 x 88 mm	10,72	1	BBS108

CONJUNTO DE EXTRATOR PARA BRAÇO DE PARA-BRISAS



BBS165

	€		
117 x 25 x 78 mm	114,46	10	BBS165



Extrator para braço de pára brisas



BBS170P13

	€		
80 x 275 x 375 mm	212,74	1	BBS170P13
	10,97	1	BBS170P131
	10,97	1	BBS170P132
	10,97	1	BBS170P133
	10,97	1	BBS170P134
	10,97	1	BBS170P135
	10,97	1	BBS170P136
	10,97	1	BBS170P137
	12,72	1	BBS170P138
	13,56	1	BBS170P139
	16,99	50	BBS165SP4

Martelo para reparação de carroçarias Fresada



BBSH1M

	€		
50x30 mm	61,20	1	BBSH1M

Martelo para reparação de carroçarias Chato redondo



BBSH2F

	€		
40 mm	44,44	6	BBSH2F

Martelo para reparação de carroçarias Convexo redondo



BBSH2C

	€		
40 mm	44,44	1	BBSH2C

Martelo para reparação de carroçarias Chato quadrado-convexo redondo



BBSH3CF

		€		
40 mm	37 mm	45,46	6	BBSH3CF

Martelo Deslizante de 12Kg



BBS12SH

		€		
800 mm	12 kg	435,81	1	BBS12SH

Martelo para reparação de carroçarias Convexo redondo



BBSH2CA

	€		
40 mm	49,82	12	BBSH2CA

Martelo para reparação de carroçarias Chato quadrado-convexo redondo



BBSH3CF30

		€		
30 mm	25 mm	48,35	6	BBSH3CF30

Martelo para reparação de carroçarias Face recta



BBSH1F

	€		
50x30 mm	43,57	1	BBSH1F

Martelo para reparação de carroçarias Convexo redondo



BBSH2CP

	€		
40 mm	45,13	6	BBSH2CP

Martelo para reparação de carroçarias Chato redondo- quadrado fresado



BBSH3FS

		€		
37 mm	40 mm	48,44	6	BBSH3FS

Martelo para reparação de corroçarias
Fresado redondo - chato quadrado



BBSH3MF

		€		
30 mm	27 mm	47,18	1	BBSH3MF

Cabo de substituição para martelos BBSH



BBSHWH1

	€		
160 g	15,48	1	BBSHWH1

Encontrador forma americano



BBSDA

	€		
30 x 63 x 83 mm	58,16	1	BBSDA

Encontrador forma de aspa



BBSDC

	€		
40 x 58 x 128 mm	60,42	6	BBSDC

Encontrador forma de diabo



BBSDD

	€		
55 x 55 x 55 mm	45,76	1	BBSDD

Encontrador forma de calcanhar



BBSDH

	€		
30 x 60 x 79 mm	54,03	1	BBSDH

Encontrador forma de dedo



BBSDT

	€		
26 x 58 x 120 mm	65,73	6	BBSDT

Encontrador forma de cunha



BBSDW

	€		
25 x 64 x 112 mm	45,23	6	BBSDW

Encontrador forma calcanhar em borracha



BBSDHR

	€		
40 x 62 x 75 mm	24,13	1	BBSDHR

Colher singular



BBSS1

	€		
25 x 56 x 390 mm	103,77	1	BBSS1

Colher dupla curta



BBSS2

	€		
150 x 60 x 410 mm	112,94	8	BBSS2

Colher dupla longa



BBSS2L

		€		
175 x 60 x 520 mm	2.3 kg	118,14	1	BBSS2L



Chave removedora de molas de plástico



2485

	€		
240 mm	9,31	1	2485

Alicate para remover plásticos de porta



BBS200

	€		
65 x 75 x 250 mm	43,09	1	BBS200

Jogo remoção painéis automóveis. 12 pcs



BBS20P12

	€		
35 x 355 x 585 mm	61,94	1	BBS20P12

12 pcs

Kit de reparação de plásticos



BBS210

	€		
100 x 280 x 360 mm	399,91	1	BBS210
22 x 64 x 106 mm	24,01	1	BBS210U06
22 x 64 x 106 mm	26,15	1	BBS210U08
22 x 64 x 106 mm	29,09	1	BBS210UA06
22 x 64 x 106 mm	32,02	1	BBS210UA08
22 x 64 x 106 mm	24,01	1	BBS210V06
22 x 64 x 106 mm	26,15	1	BBS210V08
22 x 64 x 106 mm	31,30	1	BBS210W06
22 x 64 x 106 mm	34,18	1	BBS210W08

Ferramenta de remoção do conjunto Air bag. 12 pcs (VW, Audi, Mercedes, BMW, Opel, Renault...)



BBS100

	€		
55 x 160 x 275 mm	75,40	1	BBS100
	7,55	1	BBS10001
	13,33	1	BBS10002
	9,07	1	BBS10003
	20,84	1	BBS10004
	5,01	1	BBS10005
	2,18	1	BBS100057
	3,48	1	BBS10006
	3,35	1	BBS10007
	3,48	1	BBS10008
	3,35	1	BBS10009
	3,35	1	BBS10010

12 pcs (VW, Audi, Mercedes, BMW, Opel, Renault...)

Raspadores para carroçaria



2220

	€		
125 g	19,27	1	22209004B

Alicate de rebites M3-M6 1468-M6: Conjunto



1468-M6

	€		
20 x 110 x 265 mm	102,22	1	1468-M6

Alicate de rebites M4-M10



1468-M10

	€		
50 x 210 x 575 mm	256,78	6	1468-M10

Inserções para rebitor de porcas 1468-M6



1468-6M

📦	€	📦	🐟
15 x 15 x 50 mm	5,02	1	1468-6M3
13 x 13 x 50 mm	5,02	1	1468-6M4
25 x 25 x 55 mm	5,02	1	1468-6M5
20 x 20 x 55 mm	5,02	1	1468-6M6

Inserções para rebitor de porcas 1468-M10



1468-10M

📦	€	📦	🐟
17 x 17 x 90 mm	19,65	1	1468-10M4
17 x 17 x 90 mm	19,65	1	1468-10M5
20 x 20 x 90 mm	19,65	1	1468-10M6
20 x 20 x 85 mm	19,65	1	1468-10M8
20 x 20 x 85 mm	19,65	1	1468-10M10

Jogo hidraulico portátil para carroçarias 4T e 10T



BH8PR

📦	kg	€	📦	🐟
220 x 480 x 1030 mm	31 kg	397,21	1	BH8PR10000
168 x 345 x 575 mm	18.65 kg	264,91	1	BH8PR4000

BH8PR4000: 4T

Grampo



BH8BC1

📦	€	📦	🐟
45 x 135 x 230 mm	115,10	1	BH8BC1

Grampo



BH8BC2

📦	€	📦	🐟
51 x 150 x 220 mm	137,56	1	BH8BC2

Grampo



BH8BC3

📦	€	📦	🐟
90 x 65 x 240 mm	108,76	10	BH8BC3

Grampo



BH8BC4

📦	€	📦	🐟
80 x 120 x 175 mm	233,82	6	BH8BC4

Grampo



BH8BC5

📦	€	📦	🐟
45 x 155 x 230 mm	161,52	6	BH8BC5

EQUIPAMENTO DE ELEVAÇÃO

Macaco de garrafa



BH4S

📦	📦	€	📦	🐟
2000 kg	180 x 83 x 93 mm	34,61	6	BH4S2
4000 kg	190 x 91 x 100 mm	54,08	6	BH4S4
6000 kg	215 x 96 x 114 mm	64,89	4	BH4S6
8000 kg	230 x 103 x 120 mm	77,87	4	BH4S8
12000 kg	235 x 117 x 135 mm	84,36	3	BH4S12
20000 kg	240 x 145 x 153 mm	129,78	1	BH4S20
50000 kg	240 x 315 x 220 mm	281,19	1	BH4S50



Macaco de Garrafa



BH4

Capacidade	Dimensões (mm)	Preço (€)	Quantidade	Modelo
2000 kg	180 x 103 x 103 mm	86,52	1	BH42
5000 kg	210 x 110 x 110 mm	108,15	1	BH45
10000 kg	220 x 124 x 128 mm	140,60	1	BH410
15000 kg	235 x 140 x 140 mm	173,04	2	BH415
20000 kg	240 x 165 x 160 mm	205,49	1	BH420
30000 kg	245 x 185 x 175 mm	259,56	2	BH430

Macaco de carrinho em alumínio 2,5 T



BH1A2500A

Capacidade	Dimensões (mm)	Preço (€)	Quantidade	Modelo
2500 kg	205 x 385 x 800 mm	565,08	1	BH1A2500A

Macaco extra longo 1,5 T. Macaco de elevação extra 1.5T



BH11500

Capacidade	Dimensões (mm)	Preço (€)	Quantidade	Modelo
1500 kg	1270 x 364 x 945 mm	579,46	1	BH11500

Macaco de elevação extra 1.5T

Macaco hidráulico com garrafa soldada



BH4HP50

Capacidade	Dimensões (mm)	Preço (€)	Quantidade	Modelo
50000 kg	300 x 210 x 310 mm	713,79	1	BH4HP50

Macaco com capacidade até 3000Kg



BH1EU3000

Capacidade	Dimensões (mm)	Preço (€)	Quantidade	Modelo
3000 kg	1400 x 340 x 617 mm	254,95	1	BH1EU3000

Macaco entrada extra baixo 2T. Macaco para 2T



BH12000

Capacidade	Dimensões (mm)	Preço (€)	Quantidade	Modelo
2000 kg	1270 x 364 x 780 mm	515,08	1	BH12000

Macaco para 2T

Macaco de carrinho em alumínio 1,5 T



BH1A1500A

Capacidade	Dimensões (mm)	Preço (€)	Quantidade	Modelo
1500 kg	170 x 370 x 660 mm	368,79	1	BH1A1500A

Macaco multiusos com capacidade até 1000Kg



BH1M1000

Capacidade	Dimensões (mm)	Preço (€)	Quantidade	Modelo
1000 kg	1280 x 478 x 700 mm	862,74	1	BH1M1000

Macaco de elevação extra 3T



BH13000

Capacidade	Dimensões (mm)	Preço (€)	Quantidade	Modelo
3000 kg	1280 x 364 x 825 mm	396,61	1	BH13000

Macaco de rodas de 3 T com abordagem rápida



BH13000QA

		€		
3000 kg	220 x 395 x 900 mm	582,96	1	BH13000QA

Adaptador para macaco com capacidade até 1 Tonelada



BH1CB1000

		€		
1000 kg	145 x 125 x 710 mm	179,01	1	BH1CB1000

Macaco de rodas de grande elevação e chassis longo de 3 T



BH13000L

		€		
3000 kg	1310 x 530 x 1370 mm	1.249,05	1	BH13000L

Macaco para 5T



BH15000B

		€		
5000 kg	330 x 520 x 1670 mm	1.055,75	1	BH15000B

Macaco para 10T



BH110000B

		€		
10000 kg	270 x 520 x 1670 mm	1.581,05	1	BH110000B

Extensão 120 mm para macacos ref. BH15000A e ref. BH110000A



BH15000A-EXT/BH110000A-EXT

	€		
108 mm	102,75	1	BH15000A-EXT
151 mm	138,73	1	BH110000A-EXT

Macaco articulado 4-5 T p/empilhadoras, veículos agrícolas e industriais



BH1S45

		€		
4000 kg	1194 x 212 x 680 mm	746,86	1	BH1S45

Base de borracha de substituição



BH1RS

	€		
BH1A1500A	10,28	40	BH1A1500A-05
BH1EU3000	6,81	1	BH1EU3000-03
BH11500, BH12000, BH13000, BH13000QA, BH13000L, BH1M1000, BH1A2500A	6,63	1	BH11500-04
BH15000A	4,62	1	BH15000A-04
BH110000A	12,23	1	BH110000A-04

Rodas dianteiras de substituição para macacos



BH1 FW

	€		
BH1A2500	77,84	1	BH1A2500-03
BH13000	22,57	1	BH13000-02
BH1EU3000	13,64	1	BH1EU3000-01
BH1M1000, BH11500, BH12000	17,73	1	BH11500-02
BH1S45	10,90	1	BH1S45-03
BH15000A	57,82	1	BH15000A-02
BH110000A	104,98	1	BH110000A-02



Macaco insuflável de 2 passos



BH9BJ22SSH

		€		
2000 kg	345 x 265 x 265 mm	733,97	1	BH9BJ22SSH

Macaco insuflável de 2 passos



BH9BJ22

		€		
2000 kg	1000 x 265 x 265 mm	753,25	1	BH9BJ22SLH

Macaco insuflável de 3 passos



BH9BJ23SSH

		€		
2000 kg	490 x 250 x 250 mm	992,20	1	BH9BJ23SSH

Macaco insuflável de 3 passos



BH9BJ23

		€		
2000 kg	1000 x 250 x 250 mm	1.011,51	1	BH9BJ23SLH

Extensões para macacos pneumáticos



BH9BJ260_80

	€		
970 g	35,84	1	BH9BJ260
1180 g	41,57	1	BH9BJ280

Macaco Hidráulico 30 Ton



BH230

		€		
360 mm	627 mm	3.347,99	1	BH230

Macaco pneumático-hidráulico compacto 30/15T



BH23015C

		€		
30000 kg	1350 x 290 x 430 mm	1.673,99	1	BH23015C

Macaco pneumático-hidráulico 30/15T



BH23015

		€		
30000 kg	1250 x 282 x 810 mm	2.685,25	1	BH23015

Macaco pneumático-hidráulico 40/20/10T.
Jack 40/20/10T



BH2402010

		€		
40000 kg	1225 x 302 x 825 mm	2.304,96	1	BH2402010

Jack 40/20/10T

Macaco pneumático-hidráulico 60/40/20T.
Jack 60/40/10T



BH2604020

		€		
60000 kg	1250 x 295 x 875 mm	3.154,83	1	BH2604020

Jack 60/40/10T

Macaco Hidráulico 80/50T



BH28050

		€		
80000 kg	380 x 470 x 1200 mm	3.743,34	1	BH28050

CONJUNTO DE ADAPTADORES



BH2AC

		€		
67 mm	45-75 mm	55,96	1	BH2AC1
75 mm	45-75 mm	77,84	1	BH2AC2

Par de preguiças de alumínio com 2500 kg de capacidade



BH3AL2500

	€		
2500 kg	151,95	1	BH3AL2500

Cavelete de Cremalheira



BH33000/BH36000

	€		
3000 kg	64,89	1	BH33000
6000 kg	127,62	1	BH36000

Cavelete de subida automática



BH3A

	€		
3000 kg	108,15	1	BH3A3000
5000 kg	162,23	1	BH3A5000
10000 kg	289,34	1	BH3A10000

Cavelete de base quadrada



BH3SQ

	€		
7000 kg	123,81	2	BH3SQ7000
15000 kg	247,61	2	BH3SQ15000

Cavelete para veiculos pesados



BH3HD8000

	€		
8000 kg	124,17	2	BH3HD8000

Preguiça de alta resistência



BH3HD12000

	€		
12000 kg	219,11	1	BH3HD12000



Preguiça de alta resistência



BH3HD16000

	€		
16000 kg	262,90	1	BH3HD16000

Pistão macaco fosso hidráulico duplo c/1000 kg de capacidade



BH5DP1000QA

		€		
1000 kg	1954 x 759 x 759 mm	925,85	1	BH5DP1000QA

Quadro de armazenamento para carrinhos



BH1CD680ST

		€		
715 x 130 x 155 mm	135 kg	97,34	1	BH1CD680ST

Preguiça de 20 T para trabalhos pesados



BH3HD20000A

	€		
20000 kg	315,61	1	BH3HD20000A

Base universal para macacos de fosso



BH5US1000

		€		
250 x 340 x 420 mm	260-510 mm	236,42	1	BH5US1000

Plataforma hidráulica c/rodas, 600 kg capacidade



BH8AC3-600

		€		
1030 x 1050 x 1020 mm	93.5 kg	973,35	1	BH8AC3-600

Pistão macaco fosso hidráulico único c/500 kg de capacidade



BH5SP500QA

		€		
500 kg	2041 x 660 x 660 mm	499,11	1	BH5SP500QA

Carrinho para manobrar veículos



BH1CD680

		€		
16.22 kg	610 x 240 x 220 mm	198,30	1	BH1CD680

Macaco saca-rodas hidráulico p/equip. pesados agrícolas e de construção 1.5T



BH8AC3-1500A

		€		
310 x 1070 x 1345 mm	132 kg	1.879,75	1	BH8AC3-1500A

Grua de garagem 600Kg



BH6PC600

		€		
2315 x 1040 x 1480 mm	96 kg	1.004,39	1	BH6PC600

Grua de Garagem 2Ton



BH6FC2000

		€		
2640 x 1220 x 1845 mm	170 kg	1.339,19	1	BH6FC2000

Frasco sobresselente de óleo hidráulico 250 ml ISO VG15



BHVG15-250

		€		
160 x 60 x 60 mm	220 g	9,88	1	BHVG15-250

Grua de Garagem 1Ton. Altura máxima 2m



BH6FC1000

		€		
2175 x 1030 x 1480 mm	85 kg	832,76	1	BH6FC1000

Altura máxima 2m

Equilibrador de carga do motor



BH6AC1-680A

	€		
565 x 12 x 774 mm	116,80	1	BH6AC1-680A

Rodas traseiras de substituição para macacos



BH1_RW

	€		
BH1A1500	33,57	1	BH1A1500-04
BH1A2500	59,32	1	BH1A2500-04
BH1M1000,BH11500,BH12000, BH13000	25,19	1	BH11500-01
BH1EU3000	24,14	1	BH1EU3000-08
BH13000L	16,90	1	BH13000L-01
BH1S45-01	22,97	1	BH1S45-01
BH15000A,BH110000A	27,18	1	BH15000A-01





BAHCO



Equipamento de iluminação



LANTERNAS

Lanterna pequena



BLTS7P

	€		
45 lm	56,38	58	BLTS7P

Lanterna flexível e lâmpada COB



BLTFC1

	€		
180 lm	95,01	20	BLTFC1

Lanterna extra leve



BLTS10

	€		
400 lm	62,00	20	BLTS10

LUZES PARA A CABEÇA

Lanterna de cabeça. 260 lúmens e 2 modos de luz



BFRL11

	€		
260 lm	60,78	1	BFRL11

ENROLADORES DE CABO

Bobine de cabo de 230V



BLCR230

		€		
230 V	800/2000 W	254,92	1	BLCR230FR
230 V	800/2000 W	254,92	1	BLCR230SC

Bobine de cabo de 24V



BLCR24V

		€		
230/24 V	60 W	436,99	1	BLCR24VCL
230/24 V	60 W	589,58	1	BLCR24VLL

Bobine de cabo de 400V



BLCR400E

		€		
400 V	2800/5000 W	902,97	1	BLCR400E

Adaptador de controlo de velocidade para enrolador



BLCRSC

BLCR		€		
230PL,FR,SC 76 x 91 x 117 mm		94,79	1	BLCRSC1
24VCL,VLL 76 x 91 x 117 mm		94,79	1	BLCRSC2



Ferramentas de inspeção



ENDOSCÓPIOS

Videoscópio



BE210

Dimensões	Peso (kg)	Preço (€)	Quantidade	Modelo
5 x 50 x 56 mm	0.04 kg	69,95	1	ZHVIDEOBAT
40 x 44 x 75 mm	0.17 kg	28,56	1	ZHVIDEOCHA

Lentes e Cabos. Para BE200 e BE210



BE200C

Diâmetro (mm)	Comprimento (m)	Preço (€)	Quantidade	Modelo
25 mm	10 m	2.526,98	1	BE200CAB250SH10
25 mm	25 m	3.497,70	1	BE200CAB250SH25
25 mm	3 m	1.684,68	1	BE200CAB250SH3
4 mm	1 m	1.099,04	1	BE200CAB40F1
5.5 mm	1 m	770,13	1	BE200CAB55F1
5.5 mm	3 m	1.018,83	1	BE200CAB55F3
5.8 mm	1 m	786,19	1	BE200CAB58SR1
5.8 mm	3 m	1.042,90	1	BE200CAB58SR3
8 mm	1 m	410,50	1	BE200CAB80SR1
8 mm	3 m	788,05	1	BE200CAB80SR3

Para BE200 e BE210

Espelhos e Pontas magnéticas



BE200M

Ângulo	Quantidade	Preço (€)	Quantidade	Modelo
0°	4	70,02	1	BE200MAG4
0°	5.5, 5.8	75,40	1	BE200MAG55
	8	74,10	1	BE200MAG80
35°	5.5, 5.8	75,41	1	BE200MIR5535
45°	5.5, 5.8	75,41	1	BE200MIR5545
55°	5.5, 5.8	75,41	1	BE200MIR5555
35°	8	74,10	1	BE200MIR8035
45°	8	74,10	1	BE200MIR8045
55°	8	74,10	1	BE200MIR8055
35°	4	67,13	1	BE200MIR4035
55°	4	67,13	1	BE200MIR4055

Estetoscópio de Garagem



BE220

Dimensões	Peso (kg)	Preço (€)	Quantidade	Modelo
130 x 370 x 340 mm	2.94 kg	242,36	1	BE220

Poliscópio



5050

Comprimento (mm)	Preço (€)	Quantidade	Modelo
1050 mm	101,06	1	5050

ESPELHOS

Espelho articulado



5515GV

Comprimento (mm)	Diâmetro (mm)	Preço (€)	Quantidade	Modelo
215 mm	30 mm	35,72	1	5515GV

Espelho telescópico articulado



5515T-52

Comprimento (mm)	Diâmetro (mm)	Preço (€)	Quantidade	Modelo
255-450 mm	52 mm	13,37	25	5515T-52

Espelho de inspeção giratório com LED e cabo semirrígido isolado



5515FL

		€		
550 mm	62 x 38 mm	38,05	10	5515FL

Espelho de reparação com cabo metálico



5515M

		€		
210 mm	30 mm	35,59	1	5515M

LUPAS

Lupa regulável



BOM10X

	€		
180 mm	38,11	10	BOM10X

Espelho de inspeção giratório com UV e cabo semirrígido isolado



5515FUV

		€		
550 mm	65x42 mm	50,55	1	5515FUV

Espelho auxiliar pequeno



5515L

		€		
160 mm	21 mm	27,16	1	5515L

Lupa regulável



3046-OP

	€		
105 mm	40,04	12	3046-OP

Espelho de reparação plástico



5515B

		€		
220 mm	28.5 mm	25,74	25	5515B

Espelho telescópico de bolso



5515T

		€		
180-690 mm	30 mm	31,44	25	5515T





BAHCO



Extratores e puxadores



MECÂNICOS

Extratores de dois braços



4532

Ø	L	€	Icon 1	Icon 2
25-80 mm	100 mm	108,82	1	4532-A
25-80 mm	200 mm	116,99	1	4532-AL
25-130 mm	100 mm	113,69	1	4532-B
25-130 mm	200 mm	123,93	1	4532-BL
50-160 mm	150 mm	188,42	1	4532-C
50-160 mm	300 mm	208,03	1	4532-CL
60-200 mm	150 mm	194,89	1	4532-D
80-250 mm	200 mm	304,40	1	4532-E
80-350 mm	200 mm	337,81	1	4532-F
110-520 mm	200 mm	564,50	1	4532-G
110-520 mm	300 mm	653,40	1	4532-G-SO
170-640 mm	225 mm	1.033,37	1	4532-H

Extratores de dois braços



4532K-4532LK

Ø	L	€	Icon 1	Icon 2
4532-A, 4532-B	100 mm	58,88	1	4532K1
4532-C, 4532-D	150 mm	99,65	1	4532K2
4532-E, 4532-F, 4532-G	200 mm	165,43	1	4532K3
4532-H	225 mm	289,57	1	4532K4
4532-AL, 4532-BL	200 mm	79,59	1	4532LK1
4532-CL	300 mm	133,04	1	4532LK2
4532-G-SO	300 mm	223,02	1	4532LK3
4532-E, 4532-F, 4532-G, 4532-G-SO	400 mm	267,75	1	4532LK4
4532-E, 4532-F, 4532-G, 4532-G-SO	500 mm	280,38	1	4532LK5

Extratores de dois braços



4532-S

€	Icon 1	Icon 2
26,35	1	4532-OAB/S
49,89	1	4532-CD/S
89,23	1	4532-EFG/S
139,82	1	4532-H/S

Extractor universal dois braços



4532-0

Ø	L	€	Icon 1	Icon 2
20-90 mm	100 mm	122,51	1	4532-0

4532-0/B: Spare body 4532K0: Pair of spare arms

Extractor universal de 2 braços, braços longos e fuso



3115

Ø	L	€	Icon 1	Icon 2
80-250 mm	300 mm	357,63	1	3115

Conjunto de extractores de dois braços



4532ST/5

g	€	Icon 1	Icon 2
16700 g	920,85	1	4532ST/5

4532-A, 4532-B, 4532-C, 4532-D, 4532-E

Extractor de três braços



4533

Ø	L	€	Icon 1	Icon 2
150-700 mm	185 mm	2.711,70	1	4533HP
150-700 mm	200 mm	2.474,61	1	4533M
	185 mm	638,91	1	4533HPK
	200 mm	459,36	1	4533MK
		585,90	1	4533HP/S
		194,70	1	4533M/S

Elevador hidráulico



4529

Tn max	Icon 1	€	Icon 2	Icon 3
8 to	60 N·m	222,01	1	4529-8
15 to	70 N·m	267,36	1	4529-15

Braço para extractor hidráulico de três braços. e braços de substituição



4528

📏	📏	€	📦	🐟
50-350 mm	135 mm	1.168,83	1	4528-1

e braços de substituição

Extractor de dois braços



4544

📏	📏	€	📦	🐟
10-100 mm	80 mm	81,03	1	4544-1
10-120 mm	120 mm	128,25	1	4544-2
20-160 mm	160 mm	192,28	1	4544-3
20-200 mm	200 mm	262,43	1	4544-4
		19,51	1	4544-110/S
		38,45	1	4544-220/S
		61,51	1	4519-1/S
		46,73	1	4544-440/S

Extractor de três braços



4544-

📏	📏	€	📦	🐟
10-100 mm	80 mm	116,74	1	4544-10
10-120 mm	120 mm	174,49	1	4544-20
20-160 mm	160 mm	256,56	1	4544-30

Extractor de dois braços



4543

📏	📏	€	📦	🐟
10-60 mm	40 mm	35,64	1	4543-1
10-70 mm	74 mm	37,64	1	4543-2
10-90 mm	84 mm	65,63	1	4543-3
		15,06	1	4543-1/S
		15,07	1	4543-2/S
		18,03	1	4543-3/S

Extractor de três braços



4543-

📏	📏	€	📦	🐟
10-60 mm	40 mm	49,32	1	4543-10
10-70 mm	74 mm	53,31	1	4543-20
10-90 mm	84 mm	75,48	1	4543-30

Extractor de dois braços



4541

📏	📏	€	📦	🐟
20-150 mm	85 mm	109,87	1	4541-A
40-220 mm	130 mm	184,42	1	4541-B

Extractor de três braços



4542

📏	📏	€	📦	🐟
20-150 mm	85 mm	142,07	1	4542-A
40-220 mm	130 mm	234,86	1	4542-B

Extractor de dois braços



4537

📏	📏	€	📦	🐟
20-170 mm	130 mm	98,05	1	4537-1
20-230 mm	200 mm	175,44	1	4537-2
50-300 mm	250 mm	253,81	1	4537-3
50-350 mm	350 mm	299,04	1	4537-4

Extractor de três braços



4528M

📏	📏	€	📦	🐟
20-170 mm	130 mm	123,96	1	4528M1
20-230 mm	200 mm	220,66	1	4528M2
50-300 mm	250 mm	328,83	1	4528M3
50-350 mm	350 mm	397,08	1	4528M4
50-400 mm	400 mm	407,22	1	4528M5



Extractor com grampo



4519

mm		€	1	
20-110 mm	80-170 mm	270,35	1	4519-1
40-150 mm	90-270 mm	354,97	1	4519-2
40-150 mm	90-330 mm	405,06	1	4519-3

Extractor para separador da série 4551



4552

mm		€	1	
4551-A-B		142,96	1	4552-1
4551-C		206,56	1	4552-2
4551-D		318,65	1	4552-3

Extractor de rolamentos



4581N-4583N

mm		€	1	
4581NA, 4581NB		62,07	1	4581N-1
4581NB2, 4581NC, 4582NA		62,07	1	4582N-1
4581NC, 4582NA, 4582NB		77,81	1	4582N-2
4582NA, 4583NA		98,05	1	4583N-1
4582NA, 4582NB, 4583NB		117,24	1	4583N-2

Extractor de dois braços



4614

mm		€	1	
6-100 mm	70-85 mm	154,87	1	4614-1
10-140 mm	85-120 mm	189,27	1	4614-2

Separador



4551

mm		€	1	
4552-1		90,32	1	4551-A
4552-1		114,73	1	4551-B
4552-2		187,07	1	4551-C
4552-3		292,44	1	4551-D

Braço substituível



4581NA-4583NB

mm		€	1	
145 mm	4581N-1	82,41	1	4581NA
120 mm	4581N-1	88,76	1	4581NB
130 mm	4582N-1	94,95	1	4581NB2
130 mm	4582N-1, 4582N-2	95,17	1	4581NC
150 mm	4582N-1, 4582N-2, 4583N-1, 4583N-2	101,73	1	4582NA
150 mm	4582N-2, 4583N-2	106,16	1	4582NB
190 mm	4583N-1	162,35	1	4583NA
235 mm	4583N-2	266,15	1	4583NB

Conjunto de extractores



4574

mm		€	1	
105 x 300 x 360 mm		1.153,30	1	4574

4532-A, 4532-C

4532LK1, 4532LK2

4551-C

4529-15

Extractores de Garras Multiplas



4540

mm		€	1	
30-170 mm	65-140 mm	258,62	1	4540-17
		39,50	1	4540-17/S
75-250 mm	77-180 mm	382,24	1	4540-25
		49,35	1	4540-25/S

Conjunto de extractores de rolamentos



4580N/7

mm		€	1	
66 x 192 x 287 mm		1.527,27	1	4580N/7

Conjunto de extrator de rolamentos



4578

	€		
75 x 235 x 285 mm	597,74	1	4578

4581N-1, 4582N-2, 4581NA, 4581NB, 4581NB2, 4581NC

Extractor de rolamentos interior



4521N

	€		
5-7 mm	75,63	1	4521N-00
7-9 mm	75,62	1	4521N-0
9-12 mm	72,08	1	4521N-A
10-13 mm	72,08	1	4521N-B
13-17 mm	74,31	1	4521N-C
14-19 mm	74,31	1	4521N-D
16-21 mm	74,31	1	4521N-E
18-23 mm	84,52	1	4521N-F
20-25 mm	84,52	1	4521N-G
25-30 mm	86,95	1	4521N-H
30-37 mm	96,55	1	4521N-I
35-42 mm	118,97	1	4521N-K
38-45 mm	118,97	1	4521N-L
43-50 mm	148,43	1	4521N-M
40-75 mm	356,01	1	4521N-S
70-115 mm	424,78	1	4521N-T

Contra-suporte para extractores interiores.
A ser usado com 4521



4522

	€		
35-75 mm	64,56	1	4522-1
60-130 mm	102,02	1	4522-2

A ser usado com 4521

Extractor de percussão



4523G

	€		
∅10x170 mm	76,44	1	4523G

Extractor de percussão



4524G

	€		
∅16 x 250 mm	108,61	1	4524G

Mala de extracção completa



4521N/7

		€		
95 x 360 x 310 mm	6800 g	1.196,54	1	4521N/7

4521N-B, 4521N-D, 4521N-H, 4521N-I, 4521N-L, 4521N-S, 4521N-G

4522-2, 4522-1

Saca esferas universal



4545-N

		€		
Max 50 mm	18-22 mm	119,81	1	4545-N1
Max 90 mm	27-36 mm	281,45	1	4545-N11
Max 50 mm	26 mm	164,62	1	4545-N2
60-80 mm	26 mm	206,15	1	4545-N21

Extractor interior e exterior



4518

		€		
225 mm	140 mm	254,45	1	4518-3
225 mm	140 mm	310,89	1	4518-4
225 mm	140 mm	321,49	1	4518-5



Saca esferas



4545

	€		
18 mm	58,58	1	4545-1
25 mm	79,64	1	4545-2
29 mm	103,55	1	4545-3
40 mm	136,30	1	4545-4
45 mm	166,49	1	4545-5

Conjunto de extractores manutenção automóvel



4577

	€		
70 x 340 x 425 mm	1.482,71	1	4577

4545-N2	
4532-B	
4614-1	
4521N-D, 4521N-B, 4521N-H, 4521N-I, 4521N-G, 4521N-L	
4522-1	

Conjunto extrator interno e externo



4590SHS5

	€		
79 x 230 x 500 mm	200,60	4	4590SHS5

Conjunto de mini extractores



4579

	€		
65 x 210 x 275 mm	237,80	1	4579

4543-2, 4543-3, 4543-1020/B, 4543-30/B, 4543K220, 4543K330

Saca porcas hidráulico



4610

	€		
M4-M14	236,47	1	4610-1

Saca porcas mecânico



4611

	€		
to M16	79,11	1	4611-2
to M24	154,96	1	4611-3

Saca pernos



4553

	€		
5-20 mm	64,31	1	4553

Saca pernos



4591-4593

	€		
10-19 mm	76,11	1	4592
5-15 mm	65,27	1	4591
18-28 mm	93,36	1	4593

Extractor de pernos



1420-1424

	€		
M 3-6	3,37	1	1420-1.4
M 6-8	3,98	1	1421-2.1
M 8-11	5,55	1	1422-3.1
M11-14	6,82	1	1423-4.8
M14-18	8,17	1	1424-6.2

Conjunto de 5 peças de extractores de pernos



1435/5

	g	€	
15 x 50 x 90 mm	110 g	28,31	1 1435/5

1423-4.8, 1420-1.4, 1422-3.1, 1421-2.1, 1424-6.2

Conjunto de 8 peças de extractores de pernos



1435/8

	g	€	
29 x 110 x 118 mm	700 g	89,45	1 1435/8

1420-1.4, 1421-2.1, 1422-3.1, 1423-4.8, 1424-6.2

Extractores de pernos p/parafusos, cavilhas e pernos partidos



1419-M5/1419-M16

	€		
M5-M10	28,56	1	1419-M5
M8-M14	31,96	1	1419-M8
M12-M20	36,06	1	1419-M12
M16-M24	45,78	1	1419-M16

Jogo de Extractores de Parafusos Abertos. M12-M20



1419/4

	g	€	
M5-M24	430 g	129,93	1 1419/4

M12-M20

Conjunto de bits de extracção de parafusos



BWMSP15

	kg	€	
43 x 90 x 200 mm	0.54 kg	103,46	1 BWMSP15

Bits de extracção de parafusos



BWMSP15

		€	
3 mm	13 mm	5,12	1 BWMSP1501
4 mm	13 mm	5,12	1 BWMSP1502
5 mm	13 mm	5,12	1 BWMSP1503
5.5 mm	13 mm	5,12	1 BWMSP1504
6 mm	13 mm	5,12	1 BWMSP1505
8 mm	13 mm	5,12	1 BWMSP1506
10 mm	13 mm	5,12	1 BWMSP1507
1/8 in	13 mm	5,12	1 BWMSP1508
3/16 in	13 mm	5,12	1 BWMSP1509
1/4 in	13 mm	5,12	1 BWMSP1510
3/8 in	13 mm	5,12	1 BWMSP1511
11 mm	16 mm	5,58	1 BWMSP1512
12 mm	16 mm	5,58	1 BWMSP1513
14 mm	16 mm	5,58	1 BWMSP1514
1/2 in	16 mm	5,58	1 BWMSP1515

Conjunto de extractores de pernos. cavilhas e tachas



1418S

		€	
25 x 127 x 162 mm	M6-M16	173,79	1 1418S

cavilhas e tachas

1418-4, 1418-5, 1418-6, 1418-7.5, 1418-8.5



Conjunto extractor



1418

	€		
M5-M8	11,63	1	1418-4
M8-M10	13,77	1	1418-5
D11-M12	15,47	1	1418-6
M12-M14	17,61	1	1418-7.5
M14-M16	20,50	1	1418-8.5

PÉS DE CABRA

Barra combinada



2632

	€		
170 mm	23,03	1	2632

Barra Extração



3684

	€		
406 mm	24,53	1	3684-16
457 mm	33,71	1	3684-18
609 mm	43,75	1	3684-24
760 mm	73,52	1	3684-30

Barra especial



3680

	€		
400 mm	64,33	1	3680

Barra combinada com cabo plástico



2484-20/2484-60

	€		
205 mm	9,86	1	2484-20
305 mm	12,68	1	2484-30
465 mm	19,71	1	2484-45
615 mm	23,94	1	2484-60

Jogo de alavancas



2484/S4

	€		
42 x 145 x 693 mm	49,30	10	2484/S4

2484-20, 2484-30, 2484-45, 2484-60

Pé de cabra de cabeça plana com lâmina passante para martelar



2484T-20/2484T-60

	€		
210 mm	13,20	1	2484T-20
312 mm	18,86	1	2484T-30
450 mm	25,76	1	2484T-45
600 mm	30,45	1	2484T-60

4 pés de cabra de cabeça plana com lâmina passante para martelar



2484T/S4

	g	€	
42 x 145 x 693 mm	1950 g	79,47	1 2484T/S4

2484T-20, 2484T-30, 2484T-45, 2484T-60

Barra especial com cabeça convexa 90°



3683

	€		
400 mm	53,27	1	3683

Barra Extractora



3681

L	€		
304 mm	31,92	1	3681-11
406 mm	38,32	1	3681-16
503 mm	47,89	1	3681-20

FERRAMENTAS PARA "PICK-UP"

Pinça de recolha magnética em neodímio ERGO™ 4 mm x 290 mm

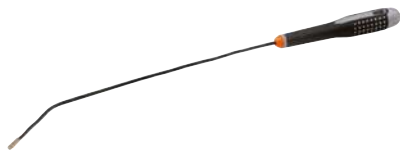

2535F0

Ø	L	€	
5.5 mm	515 mm	17,87	1 2535F0

Sensor magnético BahcoFit



B147

Ø	L	€	
13 mm	400 mm	28,29	1 B147.001.400
19 mm	400 mm	30,98	1 B147.003.400

Pick-up magnético. Chaves de parafusos



2535F

Ø	L	€	
10 mm	400 mm	39,39	1 2535F1
10 mm	400 mm	35,69	1 2535F2
17 mm	400 mm	64,65	1 2535F3

Chaves de parafusos

Ferramenta pick up magnética com luz



2535L

Ø	L	€	
20 mm	40-670 mm	27,29	12 2535L

Pick-up flexível



2509

L	€	
555 mm	77,31	50 2509

Ferramenta de captura com garra



2530

L	€	
605 mm	6,65	1 2530

FERRAMENTAS PARA ROSCAS

Jogo de machos, cançonetes e acessórios. 37 peças



1460M/1

Ø	€	
53 x 407 x 220 mm M5-M12	2.544,27	1 1460M/1

37 peças

Jogo de machos, cançonetes e acessórios. 55 peças



1460M/2

Ø	€	
53 x 407 x 220 mm M5-M20	4.340,42	1 1460M/2

55 peças



Jogo de machos, cançonetes e acessórios. 54 peças



1460Z/2

53 x 407 x 220 mm 1/4-3/4 € 6.453,23 1 1460Z/2

54 peças

Chave de punções



600

3-10 mm € 30,35 1 600.003.010
5-12 mm € 39,20 1 600.005.012

Rectificadora de interiores e exteriores



1450D-WW

230 mm € 91,34 1 1450D-WW

Conjunto de rectificadoras de interiores e exteriores



1450D/2

40 x 70 x 270 mm M5-M27 € 174,57 1 1450D/2

1450D-ISO

1450D-WW

Rectificadora de interiores e exteriores



1450D-ISO

230 mm € 91,34 1 1450D-ISO



Arrumação e kits de ferramentas



CARRINHOS DE FERRAMENTAS

Kit de ferramentas para carrinho de ferramentas de 53" - 488 peças



XXL



€



986 x 501 x 1430 mm

7.956,75

1 XXL

1476KXXL7BK	
2058-BR	
6700SM-10, 6700SM-11, 6700SM-12, 6700SM-13, 6700SM-14, 6700SM-4, 6700SM-4.5, 6700SM-5, 6700SM-5.5, 6700SM-6, 6700SM-7, 6700SM-8, 6700SM-9	
6700TORX-E10, 6700TORX-E4, 6700TORX-E5, 6700TORX-E6, 6700TORX-E7, 6700TORX-E8	
6950SL	
6954	
6956	
6960, 6962, 6962L, 696EX-11	
6963	
6966	
6972H	
7400SM-10, 7400SM-11, 7400SM-12, 7400SM-13, 7400SM-14, 7400SM-15, 7400SM-16, 7400SM-17, 7400SM-18, 7400SM-19, 7400SM-20, 7400SM-21, 7400SM-22, 7400SM-6, 7400SM-7, 7400SM-8, 7400SM-9	
7400TORX-E10, 7400TORX-E11, 7400TORX-E12, 7400TORX-E14, 7400TORX-E16, 7400TORX-E18, 7400TORX-E8	
7406ZZ-16, 7406ZZ-21	
7409BH-10, 7409BH-4, 7409BH-5, 7409BH-6, 7409BH-8	
7409F-10, 7409F-6.5, 7409F-8	
7409TORX-R-T27, 7409TORX-R-T30, 7409TORX-R-T40, 7409TORX-R-T45, 7409TORX-R-T50	
7409TORX-T25, 7409TORX-T27, 7409TORX-T30, 7409TORX-T40, 7409TORX-T45, 7409TORX-T50	
7750SL	
7757, K6650-1/4-1P	
7758	
7759	
7760	

7761-W	
7764	
7765	
7766	
7767	
776EX-11	
7800SM-10, 7800SM-11, 7800SM-12, 7800SM-13, 7800SM-14, 7800SM-15, 7800SM-16, 7800SM-17, 7800SM-18, 7800SM-19, 7800SM-20, 7800SM-21, 7800SM-22, 7800SM-23, 7800SM-24, 7800SM-25, 7800SM-26, 7800SM-27, 7800SM-28, 7800SM-29, 7800SM-30, 7800SM-32, 7800SM-33, 7800SM-34, 7800SM-36, 7800SM-8, 7800SM-9	
7800TORX-E10, 7800TORX-E11, 7800TORX-E12, 7800TORX-E14, 7800TORX-E16, 7800TORX-E18, 7800TORX-E20, 7800TORX-E24, 7800TORX-E8	
7805SM-10, 7805SM-12, 7805SM-13, 7805SM-14, 7805SM-15, 7805SM-16, 7805SM-17, 7805SM-18, 7805SM-19, 7805SM-20, 7805SM-21, 7805SM-22, 7805SM-23, 7805SM-24, 7805SM-25, 7805SM-26, 7805SM-27, 7805SM-28, 7805SM-29, 7805SM-30, 7805SM-32	
7809M-10, 7809M-12, 7809M-14, 7809M-4, 7809M-5, 7809M-6, 7809M-7, 7809M-8	
7809M-10-140, 7809M-5-100, 7809M-6-100, 7809M-7-100, 7809M-8-120	
7809XZN-10, 7809XZN-10-100, 7809XZN-12, 7809XZN-12-100, 7809XZN-14, 7809XZN-14-100, 7809XZN-16, 7809XZN-18, 7809XZN-6, 7809XZN-8, 7809XZN-8-100	
8150SL	
8160-3, 8160-5	
8160W-10	
8164-1/2	
8171	
8166	
8167	
A6800DM-10, A6800DM-11, A6800DM-12, A6800DM-13, A6800DM-14, A6800DM-4, A6800DM-5, A6800DM-5.5, A6800DM-6, A6800DM-7, A6800DM-8, A6800DM-9	
A7402DM-10, A7402DM-11, A7402DM-12, A7402DM-13, A7402DM-14, A7402DM-15, A7402DM-16, A7402DM-17, A7402DM-18, A7402DM-19, A7402DM-21, A7402DM-7, A7402DM-8, A7402DM-9	
K6625-1/4-1P	
K6650-1/2-1P, K6650-3/8-1P	
2101G-160	
2421 G-140IP, 2421 G-180	
2427 G-200	
2430 G-160	
2628 G-180	
2800-140, 2800-180, 2800-225	
2890-125, 2890-180, 2890-210	
2900-140, 2900-180, 2900-215	
2951-250	
2952-165	
2990-140, 2990-180, 2990-200	
3416 A	
4130	
7224	

BE256-155, BE256-178, BE256-250	
BLTS7P	
CR W 01	
1150-1/2H/P	
1544	
2633/S4x 4	
59/S100BCx 100	
806-1-3	
808050L	
BE-7607	
BE-8020L	
BE-8155TB, BE-8256TB, BE-8258TB	
BE-8355	
BE-8600	
BE-8602	
BE-8610TB, BE-8620TB, BE-8623TB, BE-8624TB	
BE-8802	
BE-8810TB, BE-8820TB, BE-8823TB, BE-8824TB	
BE-8907, BE-8908, BE-8909, BE-8910, BE-8915, BE-8920, BE-8925, BE-8927, BE-8930, BE-8940	
BE-8986	
BE-9770x 9	
BE-9785x 13	
MTC-5-16-C1	
1-170-08-2-2	
1-210-08-2-2	
1-230-08-2-2	
208	
2484T-30, 2484T-60	
2509	
2535L	
319	
3625N-32	
3681-16	
3734-2, 3734-3, 3734-4, 3734-5, 3734-6, 3734-8	
3735-4-120, 3735-5-120	
3740-150, 3740-250	
3906-300-32-5Px 5	
479-08	
481-1000, 481-400	
5515T	
782-U	
KBGU-5P-DISPENx 5	
KERU-01	
111M-10, 111M-11, 111M-12, 111M-13, 111M-14, 111M-15, 111M-16, 111M-17, 111M-18, 111M-19, 111M-20, 111M-21, 111M-22, 111M-23, 111M-24, 111M-25, 111M-26, 111M-27, 111M-28, 111M-29, 111M-30, 111M-32, 111M-33, 111M-34, 111M-36, 111M-6, 111M-7, 111M-8, 111M-9	
1RM-10, 1RM-11, 1RM-12, 1RM-13, 1RM-14, 1RM-15, 1RM-16, 1RM-17, 1RM-18, 1RM-19, 1RM-21, 1RM-22, 1RM-24, 1RM-27, 1RM-30, 1RM-32, 1RM-6, 1RM-7, 1RM-8, 1RM-9	
4040M-10-11, 4040M-12-13, 4040M-14-15, 4040M-16-17, 4040M-18-19, 4040M-8-9	
8069, 8071, 8073	

Carrinho caixa de ferramentas para uso geral - 758 peças



MONSTER

1370 x 501 x 1100 mm € 8.249,56 1 MONSTER

FF1BSET-MONSTER

Carrinho para kit de ferramentas para reparação auto - 357 peças



AUTO

976 x 510 x 820 mm € 4.408,04 1 AUTO

FF1ASET-AUTO

Carrinho caixa de ferramentas para uso geral - 158 peças



BASIC1

952 x 510 x 782 mm € 1.464,04 1 BASIC

FF1ASET-BASIC

Carrinho caixa de ferramentas para uso geral - 560 peças



XLARGE

1360 x 510 x 820 mm € 6.863,17 1 XLARGE

FF1ASET-XLARGE

Carrinho caixa de ferramentas para uso geral - 346 peças



LARGE

952 x 510 x 782 mm € 2.652,25 1 LARGE

FF1ASET-LARGE

Carrinho caixa de ferramentas para uso geral - 187 peças



1475KXL6CBK-FF6

986 x 501 x 1100 mm € 2.926,87 1 1475KXL6CBK-FF6

- FF1A65
- FF1A66
- FF1A67
- FF1A68
- FF1A194



Carrinho caixa de ferramentas para uso geral - 210 peças



1475KXL6CBK-FF5

€	Icon	Icon
986 x 501 x 1100 mm	3.676,50	1 1475KXL6CBK-FF5

FF1A48	Icon	Icon
FF1A49	Icon	Icon
FF1A50	Icon	Icon
FF1A51	Icon	Icon
FF1A213	Icon	Icon
FF1A53	Icon	Icon

Carrinho E77 premium. Carrinho 9 gavetas-amortecedores proteção gavetas individuais



1477K9

€	Icon	Icon
976 x 510 x 820 mm	1.468,09	1 1477K9
976 x 510 x 820 mm	1.468,09	1 1477K9BLACK
976 x 510 x 820 mm	1.468,09	1 1477K9GREY
976 x 510 x 820 mm	1.468,09	1 1477K9WHITE
976 x 510 x 820 mm	1.468,09	1 1477K9RED

Carrinho E77 premium. Carrinho 8 gavetas-amortecedores proteção gavetas individuais



1477K8

€	Icon	Icon
976 x 510 x 820 mm	1.424,39	1 1477K8
976 x 510 x 820 mm	1.424,39	1 1477K8BLACK

€	Icon	Icon
976 x 510 x 820 mm	1.424,39	1 1477K8GREY
976 x 510 x 820 mm	1.424,39	1 1477K8WHITE
976 x 510 x 820 mm	1.424,39	1 1477K8RED

Carrinho E77 premium. Carrinho 7 gavetas-amortecedores proteção gavetas individuais



1477K7

€	Icon	Icon
976 x 510 x 820 mm	1.391,59	1 1477K7
976 x 510 x 820 mm	1.391,59	1 1477K7BLACK
976 x 510 x 820 mm	1.391,59	1 1477K7GREY
976 x 510 x 820 mm	1.391,59	1 1477K7WHITE
976 x 510 x 820 mm	1.391,59	1 1477K7RED

Carrinho E77 premium. Carrinho 6 gavetas-amortecedores proteção gavetas individuais



1477K6

€	Icon	Icon
976 x 510 x 820 mm	1.326,02	1 1477K6
976 x 510 x 820 mm	1.326,02	1 1477K6BLACK
976 x 510 x 820 mm	1.326,02	1 1477K6GREY
976 x 510 x 820 mm	1.326,02	1 1477K6WHITE
976 x 510 x 820 mm	1.326,02	1 1477K6RED

Armário E87 premium. Armário 4 gavetas com amortecedores proteção gavetas individuais



1487K4

€	Icon	Icon
402 x 510 x 692 mm	1.003,31	1 1487K4
402 x 510 x 692 mm	1.003,31	1 1487K4BLACK
402 x 510 x 692 mm	1.003,31	1 1487K4GREY

Baús superiores para cubo de arrumação E87 Premium com 4 gavetas



1487K4W

€	Icon	Icon
564 x 510 x 692 mm	1.025,47	1 1487K4W
564 x 510 x 692 mm	1.003,31	1 1487K4BKW

Carrinho E72. Carrinho sólido de 8 gavetas com amortecedores de proteção



1472K8

€	Icon	Icon
952 x 510 x 782 mm	1.010,16	1 1472K8
952 x 510 x 782 mm	1.010,16	1 1472K8BLACK
952 x 510 x 782 mm	1.010,16	1 1472K8GREY
952 x 510 x 782 mm	1.010,16	1 1472K8WHITE
952 x 510 x 782 mm	1.010,16	1 1472K8RED
952 x 510 x 782 mm	1.010,16	1 1472K8BLUE

Carrinho E72. Carrinho sólido de 7 gavetas com amortecedores de proteção



1472K7

Icon	€	Icon	Icon
952 x 510 x 782 mm	972,99	1	1472K7
952 x 510 x 782 mm	972,99	1	1472K7BLACK
952 x 510 x 782 mm	972,99	1	1472K7GREY
952 x 510 x 782 mm	972,99	1	1472K7WHITE
952 x 510 x 782 mm	972,99	1	1472K7RED
952 x 510 x 782 mm	972,99	1	1472K7BLUE

Carrinho E72. Carrinho sólido de 6 gavetas com amortecedores de proteção



1472K6

Icon	€	Icon	Icon
952 x 510 x 782 mm	935,84	1	1472K6
952 x 510 x 782 mm	935,84	1	1472K6BLACK
952 x 510 x 782 mm	935,84	1	1472K6GREY
952 x 510 x 782 mm	935,84	1	1472K6WHITE
952 x 510 x 782 mm	935,84	1	1472K6RED
952 x 510 x 782 mm	935,84	1	1472K6BLUE

Carrinho E72. Carrinho sólido de 5 gavetas com amortecedores de proteção



1472K5

Icon	€	Icon	Icon
952 x 510 x 782 mm	898,16	1	1472K5
952 x 510 x 782 mm	898,16	1	1472K5BLACK
952 x 510 x 782 mm	898,16	1	1472K5GREY
952 x 510 x 782 mm	898,16	1	1472K5WHITE
952 x 510 x 782 mm	898,16	1	1472K5RED
952 x 510 x 782 mm	898,16	1	1472K5BLUE

Baús superiores para cubo de arrumação E72 de 26" com 4 gavetas



1482K4

Icon	€	Icon	Icon
386 x 510 x 692 mm	572,89	1	1482K4
386 x 510 x 692 mm	572,89	1	1482K4BLACK
386 x 510 x 692 mm	572,89	1	1482K4GREY
386 x 510 x 692 mm	572,89	1	1482K4WHITE
386 x 510 x 692 mm	572,89	1	1482K4RED
386 x 510 x 692 mm	572,89	1	1482K4BLUE

Baús superiores para cubo de arrumação E72 de 26" com rodas e 5 gavetas



1482K5W

Icon	€	Icon	Icon
542 x 515 x 699 mm	802,04	1	1482K5W

Baús superiores para cubo de arrumação E72 de 26" com rodas e 4 gavetas



1482K4W

Icon	€	Icon	Icon
542 x 515 x 699 mm	716,11	1	1482K4W
542 x 515 x 699 mm	716,11	1	1482K4BKW

Painel de ferramentas superior para 1477K



1477K-AC12

Icon	€	Icon	Icon
396 x 25 x 610 mm	177,05	1	1477K-AC12

Painel de ferramentas lateral superior para 1477K



1477K-AC13

Icon	€	Icon	Icon
400 x 25 x 365 mm	118,04	1	1477K-AC13



Prancha para documentos de trabalho para 1477K



1477K-AC14

	€		
327 x 25 x 240 mm	53,12	1	1477K-AC14

Suporte de casaco para 1477K



1477K-AC17

	€		
68 x 65 x 435 mm	47,21	1	1477K-AC17

Suporte de embalagem de spray para 1477K e 1472K



1477K-AC20

	€		
125 x 105 x 307 mm	42,49	1	1477K-AC20

Prancha de portátil para 1477K



1477K-AC15

	€		
80 x 298 x 424 mm	141,64	1	1477K-AC15

Suporte de rolo para 1477K e 1472K



1477K-AC18

	€		
33 x 265 x 313 mm	54,30	1	1477K-AC18

Suporte para ferramentas elétricas para 1477K e 1472K



1477K-AC21

	€		
115 x 175 x 302 mm	88,53	1	1477K-AC21

Suporte de para-brisas para 1477K



1477K-AC16

	€		
106 x 115 x 208 mm	236,07	1	1477K-AC16

Suporte de documentos para 1477K e 1472K



1477K-AC19

	€		
241 x 65 x 300 mm	47,21	1	1477K-AC19

Painel de ferramentas lateral para 1477K e 1472K



1477K-AC22

	€		
659 x 18 x 300 mm	65,21	1	1477K-AC22

Bandeja dobrável para carrinhos 1472K e 1477K



1477K-AC30

	€		
22 x 430 x 460 mm	123,74	1	1477K-AC30

Sistema de fecho de código PIN 1477K



1477K-AC24

	€		
135 x 36 x 62 mm	324,60	1	1477K-AC24

Topo intermédio em madeira para 1477K



1477K-ACTW

	€		
20 x 510 x 550 mm	247,88	1	1477K-ACTW

Divisórias amovíveis para gaveta para carrinho de ferramentas cubo de arrumação 1477K



1477K-AC26

	kg	€		
48 x 2 x 147 mm	0.07 kg	81,35	1	1477K-AC26

SISTEMA DE FECHO MIFARE PARA 1477K



1477K-AC25

	€		
135 x 36 x 62 mm	413,14	1	1477K-AC25

Topo de bancada composto para 1477K



1477K-ACTP

	€		
20 x 510 x 550 mm	102,70	1	1477K-ACTP

Gaveta inferior para 1477K



1477K-AC10

	€		
110 x 390 x 495 mm	92,90	1	1477K-AC10

Topo intermédio em aço inoxidável para 1477K



1477K-ACTSS

	€		
20 x 510 x 550 mm	283,29	1	1477K-ACTSS

Topo intermédio em MDF para 1477K



1477K-ACTD

	€		
20 x 510 x 550 mm	201,20	1	1477K-ACTD



Topo em aço inoxidável para 1472K



1472K-ACTSS

	€		
30 x 501 x 682 mm	330,50	1	1472K-ACTSS

Carrinhos de ferramentas 53" com 7 gavetas



1476KXXL7BK

	€		
986 x 501 x 1430 mm	2.864,43	1	1476KXXL7BK

Carrinho C75 clássico. Carrinho sólido de 12 gavetas



1475KXL12

	€		
986 x 501 x 1100 mm	1.652,81	1	1475KXL12
986 x 501 x 1100 mm	1.652,81	1	1475KXL12BLACK
986 x 501 x 1100 mm	1.652,81	1	1475KXL12RED

Topo em madeira de castanheiro para 1472K



1472K-ACTW

	€		
30 x 501 x 680 mm	305,72	1	1472K-ACTW

Carrinhos de ferramentas de banco duplo 53" com 12 gavetas



1471KXXL12BKTSS

	€		
1016 x 501 x 1440 mm	2.732,67	1	1471KXXL12BKTSS

Carrinho C75 clássico. Carrinho sólido de 8 gavetas



1475KXL8

	€		
986 x 501 x 1100 mm	1.599,25	1	1475KXL8
986 x 501 x 1100 mm	1.599,25	1	1475KXL8BLACK
986 x 501 x 1100 mm	1.599,25	1	1475KXL8BLUE
986 x 501 x 1100 mm	1.599,25	1	1475KXL8RED

Topo em MDF para 1472K



1472K-ACTD

	€		
30 x 501 x 682 mm	247,88	1	1472K-ACTD

Carrinho para ferramentas especiais 53" com 8 gavetas e armário lateral



1475KXXL8CWTSS

		€		
1218 x 500 x 1505 mm	1089 kg	4.662,48	1	1475KXXL8CWTSS

Carrinho C75 clássico. Carrinho sólido de 7 gavetas



1475KXL7

	€		
986 x 501 x 1100 mm	1.555,53	1	1475KXL7
986 x 501 x 1100 mm	1.555,53	1	1475KXL7BLACK
986 x 501 x 1100 mm	1.555,53	1	1475KXL7BLUE
986 x 501 x 1100 mm	1.555,53	1	1475KXL7RED

Carrinho C75 clássico. Carrinho sólido de 6 gavetas



1475KXL6

€	Icones	Modelo
1.500,89	1	1475KXL6
1.500,89	1	1475KXL6BLACK
1.500,89	1	1475KXL6BLUE
1.500,89	1	1475KXL6RED

Carrinho C75 clássico. Carrinho sólido de 8 gavetas



1475K8

€	Icones	Modelo
1.096,50	1	1475K8
1.096,50	1	1475K8BLACK
1.096,50	1	1475K8BLUE
1.096,50	1	1475K8RED

Carrinho de ferramentas rebaixado de 26" com 7 gavetas



1470K7LH

€	Icones	Modelo
781,13	1	1470K7LH
781,13	1	1470K7LHBLUE
781,13	1	1470K7LHGREY
781,13	1	1470K7LHRED

Carrinho C75 clássico. Carrinho com 6 gavetas e armário lateral sólido



1475KXL6C

€	Icones	Modelo
1.610,18	1	1475KXL6C
1.610,18	1	1475KXL6CBLACK

Carrinho C75 clássico. Carrinho sólido de 7 gavetas



1475K7

€	Icones	Modelo
1.055,04	1	1475K7
1.055,04	1	1475K7BLACK
1.055,04	1	1475K7BLUE
1.055,04	1	1475K7RED

Armário C85 clássico. Armário sólido de 4 gavetas



1485K4

€	Icones	Modelo
631,50	1	1485K4
631,50	1	1485K4BLACK
631,50	1	1485K4BLUE
631,50	1	1485K4RED

Armário C85 clássico. Armário sólido de 4 gavetas



1485KXL4

€	Icones	Modelo
820,36	1	1485KXL4
820,36	1	1485KXL4BLACK
820,36	1	1485KXL4BLUE
820,36	1	1485KXL4RED

Carrinho C75 clássico. Carrinho sólido de 6 gavetas



1475K6

€	Icones	Modelo
1.019,99	1	1475K6
1.019,99	1	1475K6BLACK
1.019,99	1	1475K6BLUE
1.019,99	1	1475K6RED

Topes de aço inoxidável para o carrinho de ferramentas 1475KXXL



1475KXXL-ACTSS

€	Icones	Modelo
392,53	1	1475KXXL-ACTSS



Tops de madeira de castanheiro para carrinho de ferramentas 1475KXXL



1475KXXL-ACTW

	€		
45 x 495 x 1347 mm	710,80	1	1475KXXL-ACTW

Topo em MDF 40mm



1470K-ACTD

	€		
40 x 495 x 1012 mm	252,99	1	1470KXL-ACTD
40 x 497 x 674 mm	197,45	1	1470K-ACTD

Caixa de chave de fendas/ alavanca para carrinhos de ferramentas

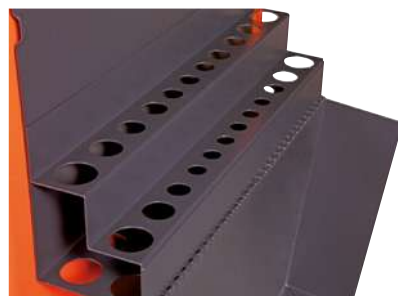

1470K-AC2

	€		
280 x 100 x 428 mm	121,98	1	1470K-AC2

Topo em aço inoxidável 40mm



1470K-ACTSS

	€		
40 x 495 x 1010 mm	462,21	1	1470KXL-ACTSS
38 x 495 x 670 mm	385,18	1	1470K-ACTSS

Armário lateral com fechadura para carrinho 1475KXL



1475KXL-AC20BK

	€		
820 x 503 x 419 mm	473,84	1	1475KXL-AC20BK

Suporte de latas para carrinhos de ferramentas



1470K-AC3

	€		
140 x 90 x 457 mm	44,94	1	1470K-AC3

Topo em castanheiro 40mm



1470K-ACTW

	€		
40 x 500 x 1012 mm	377,63	1	1470KXL-ACTW
40 x 497 x 674 mm	239,17	1	1470K-ACTW

Tabuleiro metálico dobrável para carrinhos de ferramentas



1470K-AC1

	€		
9 x 455 x 395 mm	102,72	1	1470K-AC1

Suporte de documentos para carrinhos



1470K-AC4

	€		
180 x 83 x 360 mm	51,36	1	1470K-AC4

Painel lateral com fendas e pontos para carrinhos de ferramentas



1470K-ACSIDE

	€		
822 x 20 x 418 mm	83,46	1	1470K-ACSIDE

Painel de ferramentas concebido p/ carrinho de 26 polegadas



1470K-AC8

	€		
850 x 25 x 680 mm	103,83	1	1470K-AC8
850 x 25 x 680 mm	103,83	1	1470K-AC8GR

Carros de três tabuleiros com rodízios em aço



1470KC3A

	€		
1051 x 435 x 764 mm	198,04	1	1470KC3A

Topo em ABS de 26" para carrinho de 26"



1470K-AC7

	€		
45 x 497 x 674 mm	129,58	1	1470K-AC7

Tabuleiro metálico ajustável para armário lateral



1470KXLC-TRAY

	€		
470 x 10 x 310 mm	67,89	1	1470KXLC-TRAY

Carrinho de dois tabuleiros



1470KC2

	€		
1051 x 435 x 764 mm	181,63	1	1470KC2

Painéis laterais metálicos para sistema de ganchos 1495TP



1475K-ACSIDE

	€		
822 x 20 x 418 mm	63,02	1	1475K-ACSIDE

carrinho com 3 gavetas & 2 tabuleiros



1470KC5

	€		
1051 x 435 x 1381 mm	605,37	1	1470KC5
1051 x 435 x 1381 mm	605,37	1	1470KC5PC

1 tabuleiro intermédio para carrinho 1470KC2

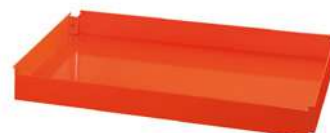

1470KCTRAY

	€		
750 mm x 420 mm	45,15	1	1470KCTRAY



Transportador dobrável com capacidade para 120 kg



1430FT120

		€		
1077 x 520 x 487 mm	6.4 kg	127,48	1	1430FT120

11 Kits de ferramentas multiusos em espuma - 758 peças



FF1BSET-MONSTER

	€		
40 x 445 x 880 mm	6.868,90	1	FF1BSET-MONSTER

FF1B01LM	
FF1B02LM	
FF1B03LM	
FF1B04LM	
FF1B05LM	
FF1B10LM	
FF1B11LM	
FF1B08LM	
FF1B09LM	
FF1B06LM	
FF1B07LM	

Inserção em espuma para o carrinho 40" para conjuntos de chaves de caixa 1/4" no sistema métrico e imperial - 141 peças



FF1B01LM

	€		
35 x 445 x 880 mm	664,55	1	FF1B01LM

6700SM-10, 6700SM-11, 6700SM-12, 6700SM-13, 6700SM-14, 6700SM-4, 6700SM-4.5, 6700SM-5, 6700SM-5.5, 6700SM-6, 6700SM-7, 6700SM-8, 6700SM-9		
6700SZ-1/2, 6700SZ-1/8, 6700SZ-9/16, 6700SZ-1/4, 6700SZ-11/32, 6700SZ-3/16, 6700SZ-3/8, 6700SZ-5/16, 6700SZ-7/16, 6700SZ-7/32, 6700SZ-9/32, 6700SZ-5/32		
6700TORX-E4, 6700TORX-E5, 6700TORX-E6, 6700TORX-E7, 6700TORX-E8, 6700TORX-E10		
6950SL		
6962L, 6960, 6961		
6972H		
7400SM-10, 7400SM-11, 7400SM-12, 7400SM-13, 7400SM-14, 7400SM-15, 7400SM-16, 7400SM-17, 7400SM-18, 7400SM-19, 7400SM-20, 7400SM-21, 7400SM-22, 7400SM-6, 7400SM-7, 7400SM-8, 7400SM-9		
7400TORX-E10, 7400TORX-E11, 7400TORX-E12, 7400TORX-E14, 7400TORX-E16, 7400TORX-E18		
7406ZZ-16, 7406ZZ-21		
7409TORX-R-T27, 7409TORX-R-T30, 7409TORX-R-T40, 7409TORX-R-T45, 7409TORX-R-T50		
7409TORX-T25, 7409TORX-T27, 7409TORX-T30, 7409TORX-T40, 7409TORX-T45, 7409TORX-T50		
7750SL		
2058-BR		
8164-1/2		
A6800DM-10, A6800DM-12, A6800DM-13, A6800DM-4, A6800DM-5, A6800DM-5.5, A6800DM-6, A6800DM-7, A6800DM-8, A6800DM-9, A6800DM-11, A6800DM-14		
A6800DZ-9/16, A6800DZ-1/2, A6800DZ-1/4, A6800DZ-11/32, A6800DZ-3/16, A6800DZ-3/8, A6800DZ-5/16, A6800DZ-7/16, A6800DZ-7/32, A6800DZ-9/32		
A7400DZ-1/2, A7400DZ-11/16, A7400DZ-3/4, A7400DZ-3/8, A7400DZ-5/8, A7400DZ-7/16, A7400DZ-17/32, A7400DZ-9/16, A7400DZ-19/32, A7400DZ-13/16, A7400DZ-7/8, A7400DZ-1/4, A7400DZ-5/16		
K6650-1/4-1P		
K6625-1/4-1P		
6954		

6956		
6963		
6966		
7760, 7761, 7762		
7764		
7765		
7766		
7409BH-4, 7409BH-5, 7409BH-6, 7409BH-8, 7409BH-10		
A7402DM-10, A7402DM-11, A7402DM-12, A7402DM-13, A7402DM-14, A7402DM-15, A7402DM-16, A7402DM-17, A7402DM-18, A7402DM-19, A7402DM-8, A7402DM-9		
K6650-3/8-1P		
7756		

Inserção em espuma para o carrinho 40" para conjuntos de chaves de caixa 1/2" no sistema métrico e imperial - 76 peças



FF1B02LM

	€		
40 x 445 x 880 mm	859,33	1	FF1B02LM

7800DM-10, 7800DM-11, 7800DM-12, 7800DM-13, 7800DM-14, 7800DM-15, 7800DM-16, 7800DM-17, 7800DM-18, 7800DM-19, 7800DM-20, 7800DM-21, 7800DM-22, 7800DM-24, 7800DM-27, 7800DM-30, 7800DM-32, 7800DM-34, 7800DM-36		
7800DZ-1, 7800DZ-1.1/16, 7800DZ-1.1/4, 7800DZ-1.1/8, 7800DZ-1.3/16, 7800DZ-1/2, 7800DZ-11/16, 7800DZ-13/16, 7800DZ-15/16, 7800DZ-25/32, 7800DZ-3/4, 7800DZ-3/8, 7800DZ-5/8, 7800DZ-7/16, 7800DZ-7/8, 7800DZ-9/16, 7800DZ-19/32		
7809M-10, 7809M-12, 7809M-14, 7809M-4, 7809M-5, 7809M-6, 7809M-7, 7809M-8		
8150SL		
SBS87		
K7801M-13, K7801M-15, K7801M-16, K7801M-17, K7801M-18, K7801M-19, K7801M-21, K7801M-22, K7801M-24		
K8160D-2		
K7806M-13, K7806M-14, K7806M-16, K7806M-17, K7806M-18, K7806M-19, K7806M-21, K7806M-22, K7806M-24		
7809M-5-100, 7809M-6-100, 7809M-7-100, 7809M-8-120, 7809M-10-140		
K6650-1/2-1P		
8160-3, 8160-5, 8160-10		
8171		
8166		

Inserção em espuma para o carrinho 40" para conjuntos de chaves de roquete e chaves combinadas - 36 peças



FF1B03LM

	€		
35 x 445 x 880 mm	607,26	1	FF1B03LM

111M-10, 111M-11, 111M-12, 111M-13, 111M-14, 111M-15, 111M-16, 111M-17, 111M-18, 111M-19, 111M-20, 111M-21, 111M-22, 111M-24, 111M-27, 111M-30, 111M-32, 111M-34, 111M-8, 111M-9	
1RM-10, 1RM-11, 1RM-12, 1RM-13, 1RM-14, 1RM-15, 1RM-16, 1RM-17, 1RM-18, 1RM-19, 1RM-21, 1RM-22, 1RM-24, 1RM-27, 1RM-8, 1RM-9	

Inserção em espuma para o carrinho 40" para chaves combinadas, chaves de cabeça flexível e espelho telescópico - 26 peças



FF1B04LM

	€		
35 x 445 x 880 mm	744,75	1	FF1B04LM

1RM-30, 1RM-32	
111Z-1, 111Z-1.1/16, 111Z-1.1/4, 111Z-1.1/8, 111Z-1/2, 111Z-11/16, 111Z-13/16, 111Z-15/16, 111Z-3/4, 111Z-3/8, 111Z-5/16, 111Z-5/8, 111Z-7/16, 111Z-7/8, 111Z-9/16	
4040M-10-11, 4040M-12-13, 4040M-14-15, 4040M-16-17, 4040M-18-19, 4040M-8-9	
5515T	
BLTS7P	
2535L	

Inserção em espuma para carrinho 40" para alicates, alicates compactos, chaves de parafusos e calibradores - 32 peças



FF1B05LM

	€		
35 x 445 x 880 mm	744,75	1	FF1B05LM

1150-1/2H/P	
1520 G	
1620	
2101S-160	
21HDG-160	
2223 S-150	
2430 G-160	
2430 S-200	
2628 G-180	
2628 S-180	
2744	
426TOR9	
KBGU-10P-DISPEN	
KERU-01	
MTC-5-16-C1	
8224	
9029, 9031	
806-1-3	
C3330R	
C3530	
C3230	
C3640	

Inserção em espuma para o carrinho 40" isolado da ERGO™ e para conjuntos de chaves de parafusos de precisão - 88 peças



FF1B06LM

	€		
40 x 445 x 880 mm	401,02	1	FF1B06LM

700-2.5-50, 700-2-50, 700-3-50	
701-00-50, 701-0-50, 701-1-75	
703-10-50, 703-15-75, 703-6-50, 703-7-50, 703-8-50, 703-9-50	
808050L	
BE-8010S	
BE-8020, BE-8040	
BE-8040SL, BE-8050SL	
BE-8150, BE-8155, BE-8256	
BE-8355	
BE-8600, BE-8611, BE-8621, BE-8623	
BE-8600S	
BE-8602	
BE-8610SL, BE-8620SL	
BE-8702, BE-8725	
BE-8820SL	
BE-8870	
BE-8975B	
BE-9777B	
BE-9787	
BE-9770	
BE-9785	

Inserção em espuma para o carrinho 40" para conjuntos de chaves de parafusos e pontas ERGO™ - 169 peças



FF1B07LM

	€		
40 x 445 x 880 mm	687,46	1	FF1B07LM

BE-8256TB, BE-8258TB	
BE-8620TB, BE-8623TB	
59/S100BC	
7455-200	
BE-8907, BE-8908, BE-8909, BE-8910, BE-8915, BE-8920, BE-8925, BE-8927, BE-8930, BE-8940	
BE-8811, BE-8821	
BE-8830	
BE-8802	
BE5049T	
BE-7607	



Inserção em espuma para o carrinho 40" para conjuntos de martelos, limas e ferramentas de extração - 45 peças



FF1B08LM

40 x 445 x 880 mm € 401,02 1 FF1B08LM

1-100-08-2-2	
1-170-08-2-2	
1-210-08-2-2	
1-230-08-2-2	
1435/5	
2484-30, 2484-45, 2484-60	
3734-2, 3734-3, 3734-4, 3734-5, 3734-6, 3734-8	
3735-4-120, 3735-5-120	
3740-150, 3740-250	
4543-3	
4611-3	
481-400	
7865	
3625N-32	
1418-4, 1418-5, 1418-6, 1418-7.5	

Inserção em espuma para o carrinho 40" para conjuntos de chaves sextavadas com pega em T, pés de cabra de várias posições e calibradores de lâminas - 21 peças



FF1B09LM

35 x 445 x 880 mm € 320,82 1 FF1B09LM

900T-025-100, 900T-030-100, 900T-040-150, 900T-050-150, 900T-060-200, 900T-080-200	
901T-010-100, 901T-015-150, 901T-020-150, 901T-025-150, 901T-027-150, 901T-030-200, 901T-040-200	
BE256-155, BE256-178, BE256-250	
BE66152	
BT10P325, BT10P330, BT10P338	
1544	

Inserção em espuma para carrinho 40" para serrotes, alicates para anéis de retenção e de pressão - 20 peças



FF1B10LM

45 x 445 x 880 mm € 423,94 1 FF1B10LM

2633/S4	
2800-140, 2800-180	
2890-125, 2890-180	
2900-140, 2900-180	
2951-180	
2952-165	
2963-280	
2965-200	
2990-125, 2990-180	
BE-8986	
325	
2681	
CR B 02	

Inserção em espuma para o carrinho 40" para conjuntos de chaves de caixa 3/4", e de cliques de metal para chaves de caixa 1/4", 3/8", 1/2" - 104 peças



FF1B11LM

50 x 445 x 880 mm € 412,48 1 FF1B11LM

RAIL-264	
CLIPS-1/4	
CLIPS-3/8	
CLIPS-1/2	
SLX 17	

12 Kits de ferramentas multiusos em espuma - 560 peças



FF1ASET-XLARGE

40 x 543 x 445 mm € 4.743,50 1 FF1ASET-XLARGE

FF1A195LM	
FF1A196LM	
FF1A197LM	
FF1A198LM	
FF1A199LM	
FF1A200LM	
FF1A201LM	
FF1A202LM	
FF1A203LM	
FF1A204LM	
FF1A205LM	
FF1A206LM	

6 Kits de ferramentas multiusos em espuma - 346 peças



FF1ASET-LARGE

40 x 543 x 445 mm € 2.068,76 1 FF1ASET-LARGE

FF1A207LM	
FF1A208LM	
FF1A209LM	
FF1A210LM	
FF1A211LM	
FF1A212LM	

3 Kits de ferramentas multiusos em espuma - 158 peças



FF1ASET-BASIC

40 x 543 x 445 mm € 901,77 1 FF1ASET-BASIC

FF1A214LM	
FF1A215LM	
FF1A216LM	

CONJUNTO DE 7 ESPUMAS - COMPOSIÇÃO MRO, 256 peças



FF1ASET-MRO2

530 x 600 x 800 mm € 2.833,78 1 FF1ASET-MRO2

FF1A130	
FF1A131	
FF1A132	
FF1A133	
FF1A134	
FF1A135	
FF1A136	

CONJUNTO DE 5 ESPUMAS - COMPOSIÇÃO MRO, 188 peças



FF1ASET-MRO3

530 x 600 x 800 mm € 2.044,83 1 FF1ASET-MRO3

FF1A138	
FF1A134	
FF1A139	
FF1A141	
FF1A137	

CONJUNTO DE 4 ESPUMAS - COMPOSIÇÃO MRO, 147 peças



FF1ASET-MRO4

530 x 600 x 800 mm € 1.375,07 1 FF1ASET-MRO4

FF1A143	
FF1A145	
FF1A134	
FF1A142	

CONJUNTO DE 3 ESPUMAS - COMPOSIÇÃO MRO, 84 peças



FF1ASET-MRO5

530 x 600 x 800 mm € 1.096,63 1 FF1ASET-MRO5

FF1A147	
FF1A146	
FF1A134	

8 Kits de ferramentas em espuma para reparação auto - 357 peças



FF1ASET-AUTO

40 x 543 x 445 mm € 3.288,79 1 FF1ASET-AUTO

FF1A218LM	
FF1A219LM	
FF1A220LM	
FF1A221LM	
FF1A222LM	
FF1A223LM	
FF1A224LM	
FF1A225LM	

CONJUNTO DE 5 ESPUMAS PARA FERRAMENTAS AUTO-196



FF1ASET-AUTO1

50 x 543 x 445 mm € 2.397,98 1 FF1ASET-AUTO1

FF1A19	
FF1A20	
FF1A21	
FF1A23	
FF1A22	



CONJUNTO DE 4 ESPUMAS PARA FERRAMENTAS AUTO-168



FF1ASET-AUTO2

€ 50 x 543 x 445 mm 1.694,48 1 FF1ASET-AUTO2

FF1A19	
FF1A24	
FF1A21	
FF1A25	

CONJUNTO DE 3 ESPUMAS PARA FERRAMENTAS AUTO-140



FF1ASET-AUTO3

€ 50 x 543 x 445 mm 1.444,89 1 FF1ASET-AUTO3

FF1A28	
FF1A26	
FF1A27	

Composição de 4 gavetas para ferramentas



FF1ASET-AUTO6

€ 50 x 543 x 445 mm 1.410,55 1 FF1ASET-AUTO6

FF1A19	
FF1A72	
FF1A70	
FF1A71	

2 Kits de ferramentas em espuma para reparação auto - 62 peças



FF1ASET-AUTO-M1

€ 50 x 543 x 445 mm 887,97 1 FF1ASET-AUTO-M1

BP910	
BP909TH	
BE-9678	
BE-9675	
29M-30	
2997-250	
1995LM-9, 1995LM-8, 1995LM-6	
3750	
1177-SCRIBE	
K7801M-9, K7801M-10, K7801M-11, K7801M-12, K7801M-13, K7801M-14, K7801M-15, K7801M-16, K7801M-17, K7801M-18, K7801M-19, K7801M-21, K7801M-22, K7801M-23, K7801M-24, K7801M-30, K7801M-32	
K7806M-15, K7806M-21, K7806M-24, K7806M-27	
K8901M-32, K8901M-34, K8901M-36	
K8964D	
K8167S	

K8160D-3	
2800-150	
2900-150	
3734S/6	
BE-8258TB	

Kit de ferramentas para alinhamento de embraiagem e 2 espumas de reparação auto - 54 peças



FF1ASET-AUTO-M2

€ 60 x 543 x 445 mm 1.798,86 1 FF1ASET-AUTO-M2

BE301	
K7801TORX-E10, K7801TORX-E12, K7801TORX-E14, K7801TORX-E16, K7801TORX-E18, K7801TORX-E20	
K8160D-2	
BE301CM	
BWHEPSSH8	
BE51038, BE510310, BE510312	
BP822	
BP825	

2 Kits de ferramentas em espuma para reparação auto - 34 peças



FF1ASET-AUTO-M3

€ 40 x 543 x 445 mm 922,35 1 FF1ASET-AUTO-M3

BE1GP5T	
6968	
BE1SP1F	
BE6OF108	
BE6307414F	
BE6OFW	

BE1FFWF	
BE63064514F1	
BE6810Z, BE6810	
BE6FCP	
52	
1546	
5515M	
BE1P	
7455-60	
BE1FLD2, BE1FLD1, BE1FLD3	
BE65F65120	
7764	
8164-1/2	
BE6302712F	
6962-W	
6954	
BE6701VAG	
BE62110	
BE1310P427	
7406ZZ-21, 7406ZZ-16	
BE1SP14L	
BE1GP5	
2421GC-160IP	
8166	

2 Kits de ferramentas em espuma para reparação auto - 23 peças



FF1ASET-AUTO-M4

	€		
60 x 543 x 445 mm	1.317,64	1	FF1ASET-AUTO-M4

BS618	
4545-N1, 4545-N11	
4545-1, 4545-2	
MTB-3-16	
361-14	
8900SM-41	
BS52	
747-22, 747-21, 747-19, 747-17, 747-15, 747-14, 747-13, 747-12	
BS40VAG	
BS56	
BS100PSA1	
BS45BMW	
8157-24	
8171	

2 Kits de ferramentas em espuma para reparação auto - 32 peças



FF1ASET-AUTO-M5

	€		
45 x 543 x 445 mm	572,89	1	FF1ASET-AUTO-M5

319	
484-1000	
SB3654BM-20	
3625S-44	
B192.004.200	
BE-8258TB	
2484/S4	
6225D	
B194.030.150, B194.025.125, B194.020.100, B194.010.075	
600.005.012	
BBS165	
K7801TORX-E10, K7801TORX-E12, K7801TORX-E14, K7801TORX-E16, K7801TORX-E18, K7801TORX-E20, K7801TORX-E24	
BBR203P920, BBR203P925, BBR203P930, BBR203P940, BBR203P945, BBR203P950, BBR203P955, BBR203P960	

2 Kits de ferramentas em espuma para reparação auto - 42 peças



FF1ASET-AUTO-M6

	€		
40 x 543 x 445 mm	1.048,38	1	FF1ASET-AUTO-M6

FM10	
782-U	

BBR405	
BBR400	
BBR210P3	
BBR6131	
BBR204	
BBR1501	
BBR501011, BBR50121314	
2900-215	
7823	
BBR100	
1154	
6M-16-17, 6M-14-15	
1949M-17-19, 1949M-12-13, 1949M-10-11, 1949M-8-9	

Conjunto de chaves de caixa 1/4" e 1/2" e pontas em inserção de espuma marcada a laser 3/3 Fit&Go - 139 peças



FF1A195LM

	€		
40 x 445 x 543 mm	401,02	1	FF1A195LM

A6800DZ-9/16, A6800DZ-1/2, A6800DZ-1/4, A6800DZ-11/32, A6800DZ-3/16, A6800DZ-3/8, A6800DZ-5/16, A6800DZ-7/16, A6800DZ-7/32, A6800DZ-9/32	
K6625-1/4-1P	
K6650-1/4-1P	
6954	
6963	
K6650-3/8-1P	
7767	
8167	
2058-BR	
59/S31B	
SL25L	
S330L	



Conjunto de chaves de caixa 1/2" e conjunto de chaves de caixa longas 1/2" em inserção de espuma marcada a laser 3/3 Fit&Go - 67 peças



FF1A196LM

	€		
40 x 445 x 543 mm	504,14	1	FF1A196LM

7800DZ-1.1/16, 7800DZ-1.1/4, 7800DZ-1.1/8, 7800DZ-1.3/16, 7800DZ-1/2, 7800DZ-11/16, 7800DZ-13/16, 7800DZ-15/16, 7800DZ-25/32, 7800DZ-3/4, 7800DZ-3/8, 7800DZ-5/8, 7800DZ-7/16, 7800DZ-7/8, 7800DZ-9/16, 7800DZ-19/32		
7809M-10, 7809M-12, 7809M-14, 7809M-4, 7809M-5, 7809M-6, 7809M-7, 7809M-8		
7809M-5-100, 7809M-6-100, 7809M-7-100, 7809M-8-120, 7809M-10-140		
K6650-1/2-1P		
S1612L		
8967		
S240		

Conjunto de chaves de caixa de impacto 1/2" em inserção de espuma marcada a laser 3/3 Fit&Go para corte e medição - 36 peças



FF1A197LM

	€		
40 x 445 x 543 mm	423,94	1	FF1A197LM

1150-1/2H/P		
2744		
426TOR9		
K7801M-13, K7801M-15, K7801M-16, K7801M-17, K7801M-18, K7801M-19, K7801M-21, K7801M-22, K7801M-24		
K8160D-2		
K7806M-13, K7806M-14, K7806M-16, K7806M-17, K7806M-18, K7806M-19, K7806M-21, K7806M-22, K7806M-24		
KBGU-10P-DISPEN		

KERU-01

MTC-5-16-C1

325

1544



Conjunto de chaves combinadas em inserção de espuma com marcação a laser 3/3 Fit&Go - 20 peças



FF1A198LM

	€		
35 x 445 x 543 mm	286,44	1	FF1A198LM

111M-10, 111M-11, 111M-12, 111M-13, 111M-14, 111M-15, 111M-16, 111M-17, 111M-18, 111M-19, 111M-20, 111M-21, 111M-22, 111M-24, 111M-27, 111M-30, 111M-32, 111M-34, 111M-8, 111M-9		
--	--	--

Conjunto de chaves de roquete e chaves de cabeça articulada, em inserção de espuma ajustável com marcação a laser 3/3 Fit&Go - 23 peças



FF1A199LM

	€		
35 x 445 x 543 mm	607,26	1	FF1A199LM

1RM-10, 1RM-11, 1RM-12, 1RM-13, 1RM-14, 1RM-15, 1RM-16, 1RM-17, 1RM-18, 1RM-19, 1RM-21, 1RM-22, 1RM-24, 1RM-8, 1RM-9		
4040M-10-11, 4040M-12-13, 4040M-14-15, 4040M-16-17, 4040M-18-19, 4040M-8-9		
9029, 9031		

Conjunto de alicates de corte, para anéis de retenção, para tubos e universais em inserção de espuma marcada a laser 3/3 Fit&Go - 14 peças



FF1A200LM

	€		
35 x 445 x 543 mm	492,68	1	FF1A200LM

1520 G		
1620		
2101G-160		
2223 S-150		
2233 D-160		
2430 G-190HD		
2628 G-180		
2890-180		
2990-180		
C3330R		
C3530		
C3230		
C3640		
8224		

Conjunto de chaves de parafusos, chaves de precisão e chaves sextavadas em inserção de espuma marcada a laser 3/3 Fit&Go - 37 peças



FF1A201LM

	€		
40 x 445 x 543 mm	263,53	1	FF1A201LM

BE-8256TB		
BE-8620TB, BE-8623TB		
700-2-50		
701-00-50, 701-0-50, 701-1-75		
703-10-50, 703-15-75, 703-6-50, 703-7-50, 703-8-50, 703-9-50		
BE-8040SL		
BE-8040		

BE-8150, BE-8155, BE-8256		
BE-8355		
BE-8600, BE-8611, BE-8621, BE-8623		
BE-8602		
BE-8811, BE-8821		
BE-8802		
BE-8870		
BE-9787		

Conjunto de chaves de parafusos em L, chaves de parafusos com pega em T e chaves de parafusos ERGO™ em inserção de espuma marcada a laser 3/3 Fit&Go - 39 peças



FF1A202LM		€		
40 x 445 x 543 mm	171,87	1	FF1A202LM	

900T-025-100, 900T-030-100, 900T-040-150, 900T-050-150, 900T-060-200, 900T-080-200		
BE-8907, BE-8908, BE-8909, BE-8910, BE-8915, BE-8920, BE-8925, BE-8927, BE-8930		
BE-8702, BE-8725		
BE-9770		
BE-9785		

Conjunto de chaves de roquete, chaves de parafusos com pega em T e pontas em inserção de espuma marcada a laser 3/3 Fit&Go - 114 peças



FF1A203LM		€		
40 x 445 x 543 mm	160,41	1	FF1A203LM	

59/S100BC		
808050L		
2058-BR		
901T-010-100, 901T-015-150, 901T-020-150, 901T-025-150, 901T-027-150, 901T-030-200, 901T-040-200		

Conjunto de formões com martelos e limas em inserção de espuma marcada a laser 3/3 Fit&Go - 40 peças



FF1A204LM		€		
40 x 445 x 543 mm	263,53	1	FF1A204LM	

1-100-08-2-2		
1-170-08-2-2		
1-210-08-2-2		
1-230-08-2-2		
1435/5		
3734-2, 3734-3, 3734-4, 3734-5, 3734-6, 3734-8		
3735-4-120, 3735-5-120		
3740-150, 3740-250		
481-400		
7865		
3625N-32		
1418-4, 1418-5, 1418-6, 1418-7.5		

Conjunto com sovelas, ganchos, espelhos de inspeção e pistola de rebtagem em inserção de espuma marcada a laser 3/3 Fit&Go - 14 peças



FF1A205LM		€		
35 x 445 x 543 mm	263,53	1	FF1A205LM	

2484-45	
2633/S4	
2951-180	
5515T	
BE66152	
BE-8986	
BT10P330	
2681	
1450D-ISO	
806-1-3	
5515FL	

Conjunto de chaves de caixa 3/4" em inserção de espuma marcada a laser 3/3 Fit&Go - 17 peças



FF1A206LM		€		
50 x 445 x 543 mm	366,65	1	FF1A206LM	

SLX 17

Conjunto de chaves de caixa 1/4" e 3/8", chaves de parafusos com pega em T, calibrador e pontas em inserção de espuma marcada a laser 3/3 Fit&Go - 192 peças



FF1A207LM		€		
40 x 445 x 543 mm	446,85	1	FF1A207LM	

1150-1/2H/P		
59/S100BC		
808050L		
2058-BR		
K6650-1/4-1P		
6956		
6963		
K6650-3/8-1P		
8967/S3		
6966		
6954		
696EX-08		
904T-060-150		
905T-060-100		
6973A		
SL25L		
S330		



Conjunto de chaves de caixa 1/2" e chaves de caixa de impacto 1/2" em inserção de espuma marcada a laser 3/3 Fit&Go - 56 peças



FF1A208LM

	€		
45 x 445 x 543 mm	389,56	1	FF1A208LM

2744	
7809M-10, 7809M-12, 7809M-14, 7809M-4, 7809M-5, 7809M-6, 7809M-7, 7809M-8	
K7801M-13, K7801M-15, K7801M-16, K7801M-17, K7801M-18, K7801M-19, K7801M-21, K7801M-22, K7801M-24	
K8160D-2	
KBGU-10P-DISPEN	
KERU-01	
319	
K6650-1/2-1P	
S240	

Conjunto de chaves combinadas e pinça de recolha magnética com luz LED em inserção de espuma marcada a laser 3/3 Fit&Go - 56 peças



FF1A209LM

	€		
35 x 445 x 543 mm	320,82	1	FF1A209LM

111M-10, 111M-11, 111M-12, 111M-13, 111M-14, 111M-15, 111M-16, 111M-17, 111M-18, 111M-19, 111M-20, 111M-21, 111M-22, 111M-24, 111M-27, 111M-30, 111M-32, 111M-34, 111M-8, 111M-9	
2535L	

Conjunto de chaves de parafusos, chaves de boca e alicates ERGO™ em inserção de espuma marcada a laser 3/3 Fit&Go - 24 peças



FF1A210LM

	€		
40 x 445 x 543 mm	435,39	1	FF1A210LM

1RM-10, 1RM-11, 1RM-12, 1RM-13, 1RM-14, 1RM-15, 1RM-16, 1RM-17, 1RM-18, 1RM-19, 1RM-8, 1RM-9	
1520 G	
2101G-160	
2430 G-190HD	
2628 G-180	
BE-8602	
BE-8611, BE-8621	
BE-8811, BE-8821	
BE-8802	
8224	
9031	

Conjunto de chaves de parafusos em L, chaves de parafusos com pega em T e chaves de parafusos ERGO™ em inserção de espuma marcada a laser 3/3 Fit&Go - 35 peças

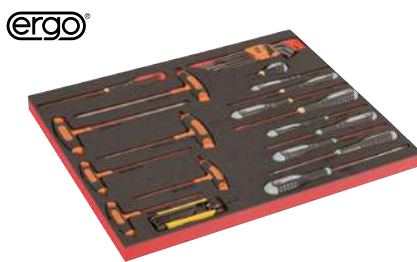

FF1A211LM

	€		
40 x 445 x 543 mm	194,78	1	FF1A211LM

900T-025-100, 900T-030-100, 900T-040-150, 900T-050-150, 900T-060-200, 900T-080-200	
BE-8910, BE-8915, BE-8920, BE-8925, BE-8930	
BE-8020, BE-8040	
BE-8050SL	
BE-8150, BE-8155	
BE-8355	
BE-9787	
BE-9770	

Conjunto de chaves de parafusos em L, chaves de parafusos com pega em T e chaves de parafusos ERGO™ em inserção de espuma marcada a laser 3/3 Fit&Go - 18 peças



FF1A212LM

	€		
35 x 445 x 543 mm	217,70	1	FF1A212LM

1-100-08-2-2	
1-210-08-2-2	
1-230-08-2-2	
3734-2, 3734-3, 3734-4, 3734-5, 3734-6, 3734-8	
3735-4-120	
3740-150, 3740-250	
426TOR9	
481-400	
BE-8986	
MTC-5-16-C1	
2446	
3625N-32	

Conjunto de chaves de caixa 1/4" e 3/8" e chaves de dinamométricas em inserção de espuma 3/3 Fit&Go - 85 peças



FF1A213

	€		
52 x 445 x 543 mm	985,36	1	FF1A213

8150SL	
7800SM-8, 7800SM-9, 7800SM-12, 7800SM-13, 7800SM-10, 7800SM-11, 7800SM-30, 7800SM-32, 7800SM-24, 7800SM-22, 7800SM-23, 7800SM-27, 7800SM-16, 7800SM-17, 7800SM-14, 7800SM-15, 7800SM-21, 7800SM-18, 7800SM-19	
7455-200	

7809TORX-T45, 7809TORX-T40, 7809TORX-T30, 7809TORX-T20, 7809TORX-T25		
7809M-6, 7809M-5, 7809M-8, 7809M-7, 7809M-10, 7809M-14, 7809M-12		
7809M-6-140, 7809M-5-180, 7809M-10- 140, 7809M-8-120		
6950SL		
6962-W, K6650-1/4-1P		
6960-W		
6968		
6700SM-9, 6700SM-10, 6700SM-7, 6700SM-8, 6700SM-13, 6700SM-14, 6700SM-11, 6700SM-12, 6700SM-4, 6700SM-6, 6700SM-5		
6709M-6, 6709M-8, 6709M-4, 6709M-5, 6709M-3		
A6709M-2.5, A6709M-5, A6709M-6, A6709M-3, A6709M-4		
6962L		
7400SM-17, 7400SM-18, 7400SM-15, 7400SM-16, 7400SM-19, 7400SM-9, 7400SM-10, 7400SM-7, 7400SM-8, 7400SM-13, 7400SM-14, 7400SM-11, 7400SM-12, 7400SM-6		
7760-W, 7761-W		
7750SL		
7768		
8160-5, 8160-10		
8166		

Conjunto de chaves de caixa 1/4" e 1/2",
alicates e pontas em inserção de espuma
marcada a laser 3/3 Fit&Go - 91 peças



FF1A214LM

	€		
40 x 445 x 543 mm	343,73	1	FF1A214LM

2058-BR		
K6650-1/4-1P		
6956		
6963		
K6650-1/2-1P		
SL25		
8072		
2971G-250		
806-1-3		
2171G-160		
59/S31B		
S240		

Conjunto de chaves de parafusos e
chaves combinadas ERGO™ em inserção
de espuma marcada a laser 3/3 Fit&Go -
31 peças



FF1A215LM

	€		
40 x 445 x 543 mm	297,90	1	FF1A215LM

111M-10, 111M-11, 111M-12, 111M-13, 111M-14, 111M-15, 111M-16, 111M-17, 111M-18, 111M-19, 111M-20, 111M-21, 111M-22, 111M-24, 111M-8, 111M-9		
BE-8910, BE-8915, BE-8920, BE-8925, BE-8930		
BE-8020, BE-8040		
BE-8155		
BE-8355		
BE-8602		
BE-8611, BE-8621		
BE-8811, BE-8821		
BE-8802		

Conjunto de martelo, ferramentas de
corte, limas e chaves em L em inserção de
espuma marcada a laser 3/3 Fit&Go - 36
peças



FF1A216LM

	€		
40 x 445 x 543 mm	229,15	1	FF1A216LM

1-100-08-2-2		
1-210-08-2-2		
1-230-08-2-2		
3734-3, 3734-4, 3734-5		
3735-4-120		
481-400		
BE-8986		
BE-9770		
S4RM-8-11, S4RM-12-15, S4RM-16-19		
KB18-01		

KSBG18-10DISPEN

MTG-3-16		
WR2-MM		
3740-200		
317		

Conjunto de chaves de caixa 1/4", chaves de caixa
para velas de ignição, chaves dinâmicas
de clique com janela em inserção de espuma
marcada a laser 3/3 Fit&Go - 79 peças



FF1A218LM

	€		
45 x 445 x 543 mm	630,17	1	FF1A218LM

1178-SCRIBE		
1547		
74WR-200		
7805ZZ-16, 7805ZZ-21		
BBR201P64014, BBR201P64016, BBR201P64018, BBR201P67814, BBR201P67816, BBR201P67818		
BWSS12P3		
MTC-3-13-C1		
7800SM-34, 7800SM-36		
SL25L		
SR200-MM		
S240		

Conjunto de chaves de caixa longas 1/2"
e pontas sextavadas em inserção de
espuma marcada a laser 3/3 Fit&Go - 49
peças



FF1A219LM

	€		
35 x 445 x 543 mm	366,65	1	FF1A219LM

1-100-08-2-2		
S1612L		
S18HEX		
S18TORX		



Conjunto de chaves combinadas e chaves ajustáveis em inserção de espuma em marcação a laser 3/3 Fit&Go - 21 peças



FF1A220LM

	€		
35 x 445 x 543 mm	309,36	1	FF1A220LM

111M-10, 111M-11, 111M-12, 111M-13, 111M-14, 111M-15, 111M-16, 111M-17, 111M-18, 111M-19, 111M-20, 111M-21, 111M-22, 111M-23, 111M-24, 111M-27, 111M-30, 111M-32, 111M-8, 111M-9	
8071	

Conjunto de chaves de roquete combinadas, chaves de cabeça articulada e chaves em L, em inserção de espuma marcada a laser 3/3 Fit&Go - 42 peças



FF1A221LM

	€		
40 x 445 x 543 mm	572,89	1	FF1A221LM

1RM-10, 1RM-11, 1RM-12, 1RM-13, 1RM-14, 1RM-17, 1RM-19, 1RM-8	
2681	
4040M-10-11, 4040M-12-13, 4040M-14-15, 4040M-16-17, 4040M-18-19, 4040M-8-9	
8045LVDE	
806-1-1	
808050	
808050S	
9715-14-250	
BE-9575	
BE-9770	

Conjunto de chaves de caixa de impacto 1/2" e conjunto de chaves de parafusos, calibrador e pontas ERGO™ em inserção de espuma marcada a laser 3/3 Fit&Go - 65 peças



FF1A222LM

	€		
45 x 445 x 543 mm	389,56	1	FF1A222LM

BE-7805, BE-7806, BE-7807, BE-7808, BE-7809, BE-7810, BE-7811, BE-7813, BE-7855	
D/S14	
K8160D-1, K8160D-2	
K8167S	
BE-8135TB, BE-8145TB, BE-8150TB, BE-8155TB	
BE-8610TB, BE-8620TB, BE-8623TB	
1150-1/2H/P	
59/S31B	

Chaves sextavadas do tipo T e alicates em inserção de espuma marcada a laser 3/3 Fit&Go - 15 peças



FF1A223LM

	€		
35 x 445 x 543 mm	332,27	1	FF1A223LM

5226 DC	
158-N	
158-NB	
21HDG-200	
2430 G-190HD	
2628G-200IP	
2968-190	
8224 IP	
BE1P	
BE1TH-2.5, BE1TH-3, BE1TH-4, BE1TH-5, BE1TH-6, BE1TH-8	

Conjunto de martelo, ferramentas de corte e abraçadeiras em inserção de espuma marcada a laser 3/3 Fit&Go - 26 peças



FF1A224LM

	€		
40 x 445 x 543 mm	274,99	1	FF1A224LM

1435/8	
319	
3625S-35	
3734S/6	
3735-5-150	
3740-200	
3750	
3906-300-24-2P	
479-16	
KBFU-01	
BE256P3	

Conjunto de sovelas, ganchos, raspador, pinça de recolha magnética e pontas TORX em inserção de espuma marcada a laser 3/3 Fit&Go - 60 peças



FF1A225LM

	€		
40 x 445 x 543 mm	286,44	1	FF1A225LM

2487	
2535F1	
2633/S4	
2485	
782-U	
BE5049T	
BE66152	
2484-45	
5515T-52	

FF1A01-77 peças



FF1A01

	€		
45 x 445 x 543 mm	699,63	1	FF1A01

A6800DM-4, A6800DM-5, A6800DM-6, A6800DM-7, A6800DM-8, A6800DM-9, A6800DM-10, A6800DM-11, A6800DM-12, A6800DM-13		
6700SM-4.5, 6700SM-5, 6700SM-5.5, 6700SM-6, 6700SM-7, 6700SM-8, 6700SM-9, 6700SM-10, 6700SM-11, 6700SM-12, 6700SM-13, 6700SM-4		
59S/22-1		
6950SL		
6954		
6956		
6960, 6961		
6966		
6972H		
7800SM-18, 7800SM-19, 7800SM-10, 7800SM-11, 7800SM-12, 7800SM-13, 7800SM-14, 7800SM-15, 7800SM-16, 7800SM-17, 7800SM-22, 7800SM-27, 7800SM-24, 7800SM-30, 7800SM-32		
7805ZZ-21		
7807H		
B191.040.100, B191.055.150		
B192.001.100, B192.002.125		
8150SL		
8154-11		
8160-3, 8160-10		
8166		

FF1A02-25 peças



FF1A02

	€		
45 x 445 x 543 mm	257,26	1	FF1A02

111M-12, 111M-13, 111M-14, 111M-17, 111M-19, 111M-22, 111M-6, 111M-7, 111M-8, 111M-10		
6M-6-7, 6M-8-9, 6M-10-11, 6M-12-13, 6M-14-15, 6M-16-17, 6M-18-19, 6M-20-22		
808050L		

FF1A03-18 peças



FF1A03

	€		
50 x 445 x 543 mm	208,29	1	FF1A03

BE-9770		
MTB-5-25		
3734N-4-150, 3734N-6-150		
1-100-08-2-2		
2171G-160		
2971G-250		
481-400		
2678 G-160		
306		

FF1A04-30 peças



FF1A04

	€		
50 x 445 x 543 mm	469,15	1	FF1A04

S4RM-12-15, S4RM-16-19, S4RM-8-11		
111M-30, 111M-32, 111M-6, 111M-7, 111M-8, 111M-9, 111M-10, 111M-11, 111M-12, 111M-13, 111M-14, 111M-15, 111M-16, 111M-17, 111M-18, 111M-19, 111M-21, 111M-22, 111M-24, 111M-27		
6M-10-11, 6M-12-13, 6M-14-15, 6M-17-19, 6M-6-7, 6M-8-9		
9071C		

Conjunto de chaves de roquete 1/2" e 1/4", chaves de caixa e pontas em inserção de espuma marcada a laser 3/3 Fit&Go - 104 peças



FF1A051

	€		
50 x 445 x 543 mm	718,11	1	FF1A051

BE-9678		
SBS60-4, SBS60-4.5, SBS60-5, SBS60-5.5, SBS60-6, SBS60-7, SBS60-8, SBS60-9, SBS60-10, SBS60-11, SBS60-12, SBS60-13, SBS60-14		
SBS61		
SBS63-2, SBS63-4, SBS63-6		
SBS65		
SBS67		
SBS69		
7800SM-10, 7800SM-11, 7800SM-12, 7800SM-13, 7800SM-14, 7800SM-15, 7800SM-16, 7800SM-18, 7800SM-19, 7800SM-21, 7800SM-17, 7800SM-22, 7800SM-24, 7800SM-27, 7800SM-32, 7800SM-30		
SBS88		
59S/31-1		
6956		
6972H		
7809M-5, 7809M-6, 7809M-7, 7809M-8, 7809M-10, 7809M-12, 7809M-14, 7809M-17, 7809M-19		
7809TORX-T20, 7809TORX-T25, 7809TORX-T27, 7809TORX-T30, 7809TORX-T40, 7809TORX-T45, 7809TORX-T50, 7809TORX-T55, 7809TORX-T60		
808050		
8150SL		
8154-11		
8160-W		
8160-10		
8166		
6954		



FF1A06-23 peças



FF1A06

45 x 445 x 543 mm 414,56 € 1 FF1A06

BE-8020L, BE-8040		
BE-8150, BE-8255, BE-8256		
BE-8350		
BE-8601		
BE-8610, BE-8620		
BE-8910, BE-8915, BE-8920, BE-8925, BE-8927, BE-8930		
MTB-3-16		
2101G-160IP		
2427 G-200 IP		
2535L		
2628 G-160IP		
2951-180		
5515T-52		
8224 IP		

FF1A07-15 peças



FF1A07

40 x 445 x 543 mm 249,17 € 1 FF1A07

3734N-3-150, 3734N-5-150, 3734N-6-150		
3735N-4-120		
3740-175		
SQZ150003		
1-100-08-2-2		
1-210-08-2-2		
1-230-08-2-2		
2744		
3625W-35		

3745-150	
481-400	
782-U	
317	

FF1A08-168 peças



FF1A08

60 x 445 x 543 mm 1.652,00 € 1 FF1A08

A6800DM-5.5, A6800DM-6, A6800DM-7, A6800DM-8, A6800DM-9, A6800DM-10, A6800DM-11, A6800DM-12, A6800DM-13		
A7402DM-10, A7402DM-11, A7402DM-12, A7402DM-13, A7402DM-14, A7402DM-15, A7402DM-16, A7402DM-17, A7402DM-18, A7402DM-19		
1544		
2058-BR		
6700SM-5.5, 6700SM-6, 6700SM-7, 6700SM-8, 6700SM-9, 6700SM-10, 6700SM-11, 6700SM-12, 6700SM-13		
6709M-3, 6709M-4, 6709M-5, 6709M-6, 6709M-8		
6709PH-1, 6709PH-2, 6709PH-3		
6709TORX-T20, 6709TORX-T25, 6709TORX-T27, 6709TORX-T30, 6709TORX-T40, 6709TORX-T8, 6709TORX-T9, 6709TORX-T10, 6709TORX-T15		
6950SL		
6954		
6956		
6958		
6960, 6961, 6962, 6962L		
6966		
6972H		
7400SM-6, 7400SM-7, 7400SM-8, 7400SM-9, 7400SM-10, 7400SM-11, 7400SM-12, 7400SM-13, 7400SM-14, 7400SM-15, 7400SM-16, 7400SM-17, 7400SM-18, 7400SM-19, 7400SM-22		
7407H		
7409M-3, 7409M-4, 7409M-5, 7409M-6, 7409M-7, 7409M-8, 7409M-10		
7409TORX-T25, 7409TORX-T27, 7409TORX-T30, 7409TORX-T40, 7409TORX-T45, 7409TORX-T50		
7750SL		
7754		
7758		
7760, 7761, 7762		
7764		
7765		

7766		
7800SM-10, 7800SM-11, 7800SM-12, 7800SM-13, 7800SM-14, 7800SM-15, 7800SM-16, 7800SM-17, 7800SM-18, 7800SM-19, 7800SM-21, 7800SM-22, 7800SM-24, 7800SM-27, 7800SM-30, 7800SM-32		
7807H		
7809M-5, 7809M-6, 7809M-7, 7809M-8, 7809M-10, 7809M-12, 7809M-14, 7809M-17, 7809M-19		
7809TORX-T20, 7809TORX-T25, 7809TORX-T27, 7809TORX-T30, 7809TORX-T40, 7809TORX-T45, 7809TORX-T55, 7809TORX-T50, 7809TORX-T60		
8150SL		
8164-1/2		
8154-11		
8160-5, 8160-10		
8171		
8166		
8172		

FF1A09-34 peças



FF1A09

50 x 445 x 543 mm 524,87 € 1 FF1A09

111M-30, 111M-32, 111M-6, 111M-7, 111M-8, 111M-9, 111M-10, 111M-11, 111M-12, 111M-13, 111M-14, 111M-15, 111M-16, 111M-17, 111M-18, 111M-19, 111M-21, 111M-22, 111M-24, 111M-27		
1320RM-10-11, 1320RM-12-13, 1320RM-8-9		
6M-6-7, 6M-8-9, 6M-10-11, 6M-12-13, 6M-14-15, 6M-16-17, 6M-18-19, 6M-20-22, 6M-24-27, 6M-30-32		
9071C		

FF1A1004-19 peças



FF1A1004

38 x 445 x 543 mm 144,62 € 1 FF1A1004

900T-050-150, 900T-020-100, 900T-025-100, 900T-030-100, 900T-040-150, 900T-060-200, 900T-080-200, 900T-100-200



BE-9777B

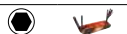

Chaves de parafusos com cabo em T 3/3, 54 peças



FF1A1010

51 x 445 x 543 mm € 237,08 1 FF1A1010

901T-010-100, 901T-015-150, 901T-020-150, 901T-025-150, 901T-027-150, 901T-030-200, 901T-040-200



808050



1419-MD



7805DM-10, 7805DM-12, 7805DM-13, 7805DM-17, 7805DM-19



BE-9678



59S/31-1



FF1A1011-12 peças

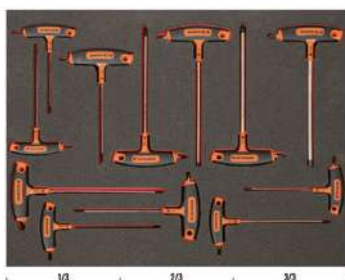

FF1A1011

35 x 445 x 543 mm € 112,46 1 FF1A1011

903T-2



903T-1



Chaves boca luneta e alicates, 24 peças



FF1A102

40 x 445 x 543 mm € 351,75 1 FF1A102

111M-32, 111M-8, 111M-9, 111M-10, 111M-11, 111M-12, 111M-13, 111M-14, 111M-15, 111M-16, 111M-17, 111M-18, 111M-19, 111M-21, 111M-22, 111M-24, 111M-27



7224



2800-180



2900-180



2890-180



2990-180



2101G-180



2628 G-180IP



Chaves e bits, 19 peças



FF1A104

35 x 445 x 543 mm € 201,53 1 FF1A104

111M-32, 111M-7, 111M-8, 111M-9, 111M-10, 111M-11, 111M-12, 111M-13, 111M-14, 111M-15, 111M-16, 111M-17, 111M-18, 111M-19, 111M-21, 111M-22, 111M-24, 111M-27



59/S54BC



Chaves de caixa, 93 peças



FF1A106

55 x 543 x 445 mm € 326,96 1 FF1A106

S87+7



FF1A11-13 peças



FF1A11

43 x 543 x 445 mm € 692,99 1 FF1A11

2101GC-125IP, 2101GC-160IP



21HDGC-200IP



2427 GC-200IP



2430 GC-200 IP



2628 GC-160IP



2928-160, 2928-200, 2928-250

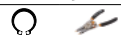

2951-250



2952-165



8224CIP



BFLA01



Ferramentas de impacto e de corte, 11 peças



FF1A110

	€		
50 x 445 x 543 mm	259,69	1	FF1A110

2535L	
426TOR9	
9572-200	
MTB-8-25	
SQZ150003	
3875-LY3	
479-24	
481-400	
529-20-L	
225-PLUS	
208	

Chaves e chaves ajustáveis, 22 peças



FF1A112

	€		
35 x 445 x 543 mm	285,65	1	FF1A112

S4RM/3T	
111M-6, 111M-7, 111M-8, 111M-9, 111M-10, 111M-11, 111M-12, 111M-13, 111M-14, 111M-15, 111M-16, 111M-17, 111M-18, 111M-19, 111M-20, 111M-21, 111M-22, 111M-24, 111M-27	
9031	
9070	

Alicates e ferramentas de impacto, 18 peças. Alicates e ferramentas de impacto, 18 peças



FF1A114

	€		
42 x 445 x 543 mm	344,67	1	FF1A114

8224 IP	
2632	
3734-2, 3734-3, 3734-4, 3734-5, 3734-6, 3734-8	
2800-180	
2890-180	
2900-180	
2990-180	
4611-2	
479-24	
1435/5	
1178-SCRIBE	
2430 G-160 IP	
2101G-180IP	

Ferramentas de medição e de corte, 9 peças. Ferramentas de medição e de corte, 9 peças



FF1A115

	€		
35 x 445 x 543 mm	232,41	1	FF1A115

1-210-08-1-2	
9045-B-250	
406T-225	
MTB-5-25	
BFLA01	
K-AP-1	
268	
5515T-52	
319	

Chaves, chaves ajust. e chaves parafusos, 26 peças



FF1A117

	€		
35 x 445 x 543 mm	227,81	1	FF1A117

B191.040.100	
B190.055.125, B190.065.150	
B192.000.075, B192.001.100, B192.002.125	
111M-32, 111M-6, 111M-7, 111M-8, 111M-9, 111M-10, 111M-11, 111M-12, 111M-13, 111M-14, 111M-15, 111M-16, 111M-17, 111M-18, 111M-19, 111M-21, 111M-22, 111M-24, 111M-27	
8073 IP	

Alicates e limas, 14 peças. Alicates e limas, 14 peças



FF1A118

	€		
35 x 445 x 543 mm	319,88	1	FF1A118

1-100-08-2-2	
2430 G-160 IP	
2628G-200IP	
2800-180	
2900-180	
2890-180	
2990-180	
5515T	
1-170-08-2-2	
1-210-08-2-2	
1-230-08-2-2	
2535F1	
8224 IP	
2101G-180IP	

Ferramentas de impacto e de corte, 10 peças. Ferramentas de impacto e de corte, 10 peças

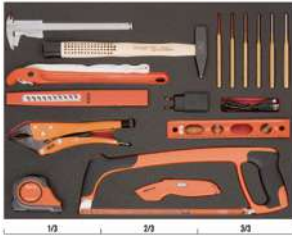

FF1A119

	€		
47 x 445 x 543 mm	297,46	1	FF1A119

3734S/6	
481-300	
KGAU-01	
MTB-5-25-M-E	
137-10	
1150-1/2H/P	
426TOR9	
BLTS10	
375-8	
319	

FF1A12-19 peças



FF1A12

	€		
35 x 445 x 543 mm	393,57	1	FF1A12

FS-8	
1-100-06-1-2, 1-100-06-2-2	
1-160-06-1-2	
1-210-06-1-2	
1-230-06-1-2	
2509	
2535F2	
3625W-35	
3734-3, 3734-5, 3734-8	
3735-4-120	
3740-150	
3745-150	
481-300, 481-500	
319	
8157-15	

Chaves e alicates, 28 peças. Chaves e alicates, 28 peças



FF1A121

	€		
40 x 445 x 543 mm	336,41	1	FF1A121

111M-8, 111M-9, 111M-10, 111M-11, 111M-12, 111M-13, 111M-14, 111M-15, 111M-16, 111M-17, 111M-18, 111M-19, 111M-22	
2470 G-200	
7224	
2953-250	
6M-6-7, 6M-8-9, 6M-10-11, 6M-12-13, 6M-14-15, 6M-16-17, 6M-18-19, 6M-20-22	
2800-180	
2900-180	
2101G-160IP	

Chaves e chaves de parafusos, 25 peças



FF1A124

	€		
45 x 445 x 543 mm	201,53	1	FF1A124

B191.040.100	
B190.055.125, B190.065.150	
B192.000.075, B192.001.100, B192.002.125	
111M-32, 111M-6, 111M-7, 111M-8, 111M-9, 111M-10, 111M-11, 111M-12, 111M-13, 111M-14, 111M-15, 111M-16, 111M-17, 111M-18, 111M-19, 111M-21, 111M-22, 111M-24, 111M-27	

Ferramentas de impacto e de corte, 11 peças

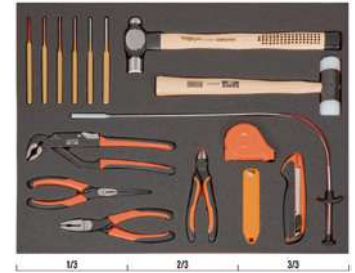

FF1A127

	€		
35 x 445 x 543 mm	248,94	1	FF1A127

3734S/6	
479-16	
3625W-35	
MTG-3-16	
KB18-01	
KSBG18-10DISPEN	
8224 IP	
2101G-160IP	
2628 G-180IP	
2430 G-200 IP	
2530	

Chaves e limas, 18 peças. Chaves e limas, 18 peças



FF1A128

	€		
65 x 445 x 543 mm	449,73	1	FF1A128

9029, 9031	
111Z-1/4, 111Z-5/16, 111Z-3/8, 111Z-7/16, 111Z-1/2, 111Z-9/16, 111Z-5/8, 111Z-11/16, 111Z-3/4, 111Z-13/16, 111Z-7/8, 111Z-1	
1-473-08-2-2	
361-12	
2633/S4	
S4RM/5T	



Alicates e chaves de parafusos, 16 peças



FF1A129

45 x 445 x 543 mm € 352,93 1 FF1A129

- 2171G-180
- 2470 G-200
- 2477 G-200
- 9033, 9035
- 1520 G
- 808050P
- B191.040.100
- B190.055.125, B190.065.150
- B192.000.075, B192.001.100, B192.002.125
- BE-9777B
- 2678 G-200
- 59S/31-1

FF1A13-83 peças



FF1A13

55 x 445 x 543 mm € 1.572,64 1 FF1A13

- A6700DZ-1/2, A6700DZ-1/4, A6700DZ-11/32, A6700DZ-3/16, A6700DZ-3/8, A6700DZ-5/16, A6700DZ-7/16, A6700DZ-7/32, A6700DZ-9/16, A6700DZ-9/32
- A6710DZ-1/2, A6710DZ-1/4, A6710DZ-11/32, A6710DZ-3/16, A6710DZ-3/8, A6710DZ-5/16, A6710DZ-7/16, A6710DZ-7/32, A6710DZ-9/16, A6710DZ-9/32
- A6800DM-4, A6800DM-10
- A6800DZ-1/2, A6800DZ-1/4, A6800DZ-11/32, A6800DZ-3/16, A6800DZ-3/8, A6800DZ-5/16, A6800DZ-7/16, A6800DZ-7/32, A6800DZ-9/16, A6800DZ-9/32
- A7400DZ-1/2, A7400DZ-1/4, A7400DZ-11/16, A7400DZ-13/16, A7400DZ-17/32, A7400DZ-19/32, A7400DZ-3/4, A7400DZ-3/8, A7400DZ-5/16, A7400DZ-5/8, A7400DZ-7/16, A7400DZ-7/8, A7400DZ-9/16

- A7402DZ-1/2, A7402DZ-1/4, A7402DZ-11/16, A7402DZ-13/16, A7402DZ-19/32, A7402DZ-3/4, A7402DZ-3/8, A7402DZ-5/16, A7402DZ-5/8, A7402DZ-7/16, A7402DZ-7/8, A7402DZ-9/16
- 6700SZ-5/32
- 6950SL
- 6954
- 6956
- 6958
- 6960, 6961, 6962, 6962L
- 6966
- 6972H
- 7407H, 7408H
- 7750SL
- 7752
- 7754
- 7758
- 7760, 7761, 7762
- 7764
- 7765
- 7766
- 8164-1/2
- U-S6106KA
- 8171

Chaves de caixa e acessórios de 1/2", 53 peças



FF1A130

45 x 445 x 543 mm € 711,25 1 FF1A130

- 7800SM-8, 7800SM-9, 7800SM-10, 7800SM-11, 7800SM-12, 7800SM-13, 7800SM-14, 7800SM-15, 7800SM-16, 7800SM-17, 7800SM-18, 7800SM-19, 7800SM-21, 7800SM-22, 7800SM-23, 7800SM-24, 7800SM-27, 7800SM-30, 7800SM-32
- 8150SL
- SBS87S, SBS87
- SBS83-3, SBS83-5, SBS83-10
- SBS85
- SBS86
- SBS88
- SBS89
- 7809TORX-T20, 7809TORX-T25, 7809TORX-T27, 7809TORX-T30, 7809TORX-T40, 7809TORX-T45, 7809TORX-T50, 7809TORX-T55, 7809TORX-T60

- 7809M-5, 7809M-6, 7809M-7, 7809M-8, 7809M-9, 7809M-10, 7809M-12, 7809M-14, 7809M-17, 7809M-19
- 7809M-5-180, 7809M-6-140, 7809M-7-100, 7809M-8-120, 7809M-10-140

Ferramentas de corte e de impacto, 25 peças



FF1A131

40 x 445 x 543 mm € 260,79 1 FF1A131

- SQZ150003
- FS-8
- SQZ150003-SBL
- 481-400
- 3734-2, 3734-4, 3734-5, 3734-6, 3734-8, 3734-3
- 3735-5-120
- 3740-175
- BE-9678
- 1547
- 319
- 208
- 3625N-32

Conjunto de ferramentas, 31 peças



FF1A132

40 x 445 x 543 mm € 385,27 1 FF1A132

- 7400SM-6, 7400SM-7, 7400SM-8, 7400SM-9, 7400SM-10, 7400SM-11, 7400SM-12, 7400SM-13, 7400SM-14, 7400SM-15, 7400SM-16, 7400SM-17, 7400SM-18, 7400SM-19
- 7750SL
- SBS705

SBS755	
SBS723, SBS724	
SBS775	
SBS760, SBS761, SBS762	
1-100-08-1-2	
1-160-08-1-2	
1-170-08-2-2	
1-210-08-1-2	
1-230-08-1-2	
2635	
1150D	
2681	

Chaves de parafusos, 17 peças



FF1A133			
	€		
35 x 445 x 543 mm	154,10	1	FF1A133

900T-020-100, 900T-025-100, 900T-030-100, 900T-040-150, 900T-050-150, 900T-060-200, 900T-080-200, 900T-100-200	
B194.006.075, B194.007.075, B194.008.075, B194.009.075, B194.010.075, B194.015.100, B194.020.100, B194.025.125, B194.030.150	

Chaves boca luneta, 21 peças



FF1A134			
	€		
37 x 445 x 543 mm	213,38	1	FF1A134

111M-30, 111M-32, 111M-6, 111M-7, 111M-8, 111M-9, 111M-10, 111M-11, 111M-12, 111M-13, 111M-14, 111M-15, 111M-16, 111M-17, 111M-18, 111M-19, 111M-20, 111M-21, 111M-22, 111M-24, 111M-27	
---	--

Chaves de bocas e de cabeça articulada, 51 peças



FF1A135			
	€		
40 x 445 x 543 mm	651,98	1	FF1A135

4040M-8-9, 4040M-10-11, 4040M-12-13, 4040M-14-15, 4040M-16-17, 4040M-18-19, 4040M-20-22, 4040M-21-23	
59S/31-1	
6M-6-7, 6M-8-9, 6M-10-11, 6M-12-13, 6M-14-15, 6M-16-17, 6M-18-19, 6M-20-22, 6M-21-23, 6M-24-27, 6M-25-28, 6M-30-32	

Conj. chaves caixa, alicates e chaves parafusos, 39 peças



FF1A136			
	€		
40 x 445 x 543 mm	438,61	1	FF1A136

2628 G-180	
2430 G-160	
8224	
2101G-160	
6700SM-4.5, 6700SM-5, 6700SM-5.5, 6700SM-6, 6700SM-7, 6700SM-8, 6700SM-9, 6700SM-10, 6700SM-11, 6700SM-12, 6700SM-13, 6700SM-14, 6700SM-4	
6950SL	
SBS67	
SBS69	
SBS65	
SBS63-2, SBS63-4, SBS63-6	
2800-180	
2890-180	

2900-180	
2990-180	
B191.030.075, B191.040.100	
B190.055.100, B190.065.125, B190.080.150	
B195.050.025	
B195.001.025	
B192.001.100, B192.002.125	
808050	
6954	

Chaves caixa e acessórios de 1/4"-1/2", 59 peças



FF1A137			
	€		
50 x 445 x 543 mm	651,98	1	FF1A137

7800SM-8, 7800SM-9, 7800SM-10, 7800SM-11, 7800SM-12, 7800SM-13, 7800SM-14, 7800SM-15, 7800SM-16, 7800SM-17, 7800SM-18, 7800SM-19, 7800SM-21, 7800SM-22, 7800SM-23, 7800SM-24, 7800SM-27, 7800SM-30, 7800SM-32	
8150SL	
SBS87S, SBS87	
SBS83-3, SBS83-5, SBS83-10	
SBS85	
SBS86	
SBS88	
SBS89	
7809TORX-T50, 7809TORX-T20, 7809TORX-T25, 7809TORX-T27, 7809TORX-T30, 7809TORX-T40, 7809TORX-T45, 7809TORX-T55, 7809TORX-T60	
6700SM-4, 6700SM-4.5, 6700SM-5, 6700SM-5.5, 6700SM-6, 6700SM-7, 6700SM-8, 6700SM-9, 6700SM-10, 6700SM-11, 6700SM-12, 6700SM-13, 6700SM-14	
6950SL	
SBS67	
SBS69	
SBS65	
SBS63-2, SBS63-4, SBS63-6	
6954	



Ferramentas de corte e de impacto, 24 peças



FF1A138

	€		
40 x 445 x 543 mm	254,87	1	FF1A138

SQZ150003	
FS-8	
SQZ150003-SBL	
481-400	
3734-2, 3734-3, 3734-4, 3734-5, 3734-6, 3734-8	
3735-5-120	
3740-175	
BE-9678	
319	
208	
3625N-32	

Chaves de parafusos, 18 peças



FF1A139

	€		
38 x 445 x 543 mm	189,67	1	FF1A139

808050	
900T-020-100, 900T-025-100, 900T-030-100, 900T-040-150, 900T-050-150, 900T-060-200, 900T-080-200, 900T-100-200	
B191.030.075, B191.040.100	
B190.055.100, B190.065.125, B190.080.150	
B195.050.025	
B195.001.025	
B192.001.100, B192.002.125	

FF1A14-43 peças



FF1A14

	€		
46 x 445 x 543 mm	695,60	1	FF1A14

111Z-1, 111Z-1/2, 111Z-1/4, 111Z-11/16, 111Z-13/16, 111Z-15/16, 111Z-3/4, 111Z-3/8, 111Z-5/16, 111Z-5/8, 111Z-7/16, 111Z-7/8, 111Z-9/16	
1320RZ-1/2-9/16, 1320RZ-1/4-5/16, 1320RZ-3/8-7/16, 1320RZ-5/16-11/32	
1931Z-1/2, 1931Z-1/4, 1931Z-11/32, 1931Z-3/16, 1931Z-3/8, 1931Z-5/16, 1931Z-5/32, 1931Z-7/16, 1931Z-7/32, 1931Z-9/16, 1931Z-9/32	
1950MZ-3/8	
1952Z-11/32	
6Z-1.1/16-1.1/4, 6Z-1-1.1/8, 6Z-1/2-9/16, 6Z-1/4-5/16, 6Z-15/16-1, 6Z-19/32-11/16, 6Z-25/32-13/16, 6Z-3/8-7/16, 6Z-5/16-11/32, 6Z-5/8-3/4, 6Z-7/8-15/16	
8069 C IP	
9070C	

Alicates e chave de cabeça articulada, 47 peças

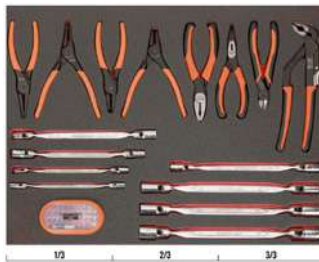

FF1A141

	€		
42 x 445 x 543 mm	734,96	1	FF1A141

2628 G-180	
2430 G-160	
8224	
2101G-160	
2800-180	
2890-180	
2900-180	
2990-180	

4040M-8-9, 4040M-10-11, 4040M-12-13, 4040M-14-15, 4040M-16-17, 4040M-18-19, 4040M-20-22, 4040M-21-23

59S/31-1

Chaves de caixa, chaves hexagonais, bits, 71 peças



FF1A142

	€		
50 x 445 x 543 mm	628,26	1	FF1A142

7800SM-8, 7800SM-9, 7800SM-10, 7800SM-11, 7800SM-12, 7800SM-13, 7800SM-14, 7800SM-15, 7800SM-16, 7800SM-17, 7800SM-18, 7800SM-19, 7800SM-21, 7800SM-22, 7800SM-23, 7800SM-24, 7800SM-27, 7800SM-30, 7800SM-32

8150SL

BE-9678

SBS87S, SBS87

1547

1150D

59S/31-1

8160-3, 8160-5, 8160-10

8166

8154-11

8171

8172

Ferramentas de corte e de impacto, 16 peças











FF1A143

	€		
45 x 445 x 543 mm	254,87	1	FF1A143

SQZ150003

FS-8

SQZ150003-SBL















MTB-5-25	
481-400	
3734-2, 3734-3, 3734-4, 3734-5, 3734-6, 3734-8	
3735-5-120	
3740-175	
319	
208	
3625N-32	

Alicates e limas, 20 peças



FF1A145

	€		
38 x 445 x 543 mm	302,28	1	FF1A145













2628 G-180	
2430 G-160	
8224	
2101G-160	
8045LVDE	
808050	
613-3-75	
611-4-100, 611-5-100, 611-6.5-150, 611-8-150, 611-6.5-25	
615-1-100, 615-2-125, 615-2-25	
1-100-08-1-2	
1-160-08-1-2	
1-170-08-2-2	
1-210-08-1-2	
1-230-08-1-2	

Chaves de caixa e alicates, 34 peças



FF1A146

	€		
50 x 445 x 543 mm	616,41	1	FF1A146











2628 G-180	
2430 G-160	
8224	
2101G-160	
FS-8	
7800SM-8, 7800SM-9, 7800SM-10, 7800SM-11, 7800SM-12, 7800SM-13, 7800SM-14, 7800SM-15, 7800SM-16, 7800SM-17, 7800SM-18, 7800SM-19, 7800SM-21, 7800SM-22, 7800SM-23, 7800SM-24, 7800SM-27, 7800SM-30, 7800SM-32	
8150SL	
SBS87S, SBS87	
8160-3, 8160-5, 8160-10	
8166	
8154-11	
8171	
8172	

Chaves parafusos e ferramentas de corte, 16 peças



FF1A147

	€		
40 x 445 x 543 mm	260,79	1	FF1A147











2951-250, 2951-180	
SQZ150003	
SQZ150003-SBL	
B191.030.075, B191.040.100	
B190.055.100, B190.065.125, B190.080.150	
B195.050.025	
B195.001.025	
B192.001.100, B192.002.125	
319	
208	
3625N-32	

FF1A15-12 peças



FF1A15

	€		
40 x 445 x 543 mm	768,30	1	FF1A15

2101GC-125IP, 2101GC-160IP	
2233D-240IP	
2421GC-180IP	
2427 GC-200IP	
2430 GC-200 IP	
2628 GC-160IP	
2650	
2855, 2855 D	
2951-180	
8224CIP	

Conjunto de chaves de caixa 1/4" e 1/2", chaves de fendas e alicates 3/3 Fit&Go - 94 peças



FF1A153

	€		
335 x 445 x 543 mm	354,11	1	FF1A153

S87+7	
-------	---



Conjunto de alicates, ferramentas de corte e martelos em inserção de espuma 3/3 Fit&Go - 13 peças



FF1A154

	€		
37 x 445 x 543 mm	183,32	1	FF1A154

2171G-160	
224 D	
2470 G-160	
317	
3625W-28	
3733-4	
3734-3, 3734-6	
3735-5-120	
481-400	
KB18-01	
KSBG18-10DISPEN	
2678 G-180	

FF1A16-18 peças



FF1A16

	€		
40 x 445 x 543 mm	560,41	1	FF1A16

KE18-01	
1150-1/2H/P	
MTB-3-16	
1177-SCRIBE	
1544	
2509	
2535F2	
2632	
268	
2744	

2820EF2	
3525HB	
5471 F-145	
5515T	
5515T-52	
5516	
BFLA01	
SR300-E	

Conjunto de chaves de caixa 1/4" e 1/2", chaves de parafusos e alicates 3/3 Fit&Go - 50 peças



FF1A164

	€		
40 x 445 x 543 mm	565,86	1	FF1A164

1RM-10, 1RM-11, 1RM-12, 1RM-13, 1RM-14, 1RM-15, 1RM-16, 1RM-17, 1RM-18, 1RM-19, 1RM-8	
2058-BR	
S330	
111M-24, 111M-21, 111M-27, 111M-32	

Conjunto de chaves de caixa 1/2" e 3/8" e pontas em inserção de espuma 3/3 Fit&Go - 177 peças



FF1A165

	€		
40 x 445 x 543 mm	320,82	1	FF1A165

59/S100B-T	
BE5049	
S1214L	
S1612L	
SBS87	
7402GPR-16	

Conjunto de alicates, chaves em L, prato magnético e pinça 3/3 Fit&Go - 23 peças



FF1A167

	€		
45 x 445 x 543 mm	330,50	1	FF1A167

1178-SCRIBE	
1419-MD	
2101G-160IP	
2430 G-190HD	
2628 G-180IP	
2744	
2953-250	
8224	
9031	
BE-9770	
BWSS12P317, BWSS12P319, BWSS12P321	
CR B 02	
2530	



Conjunto de ferramentas de corte, chaves de impacto e limas 3/3 Fit&Go - 36 peças



FF1A168





	€		
40 x 445 x 543 mm	219,99	1	FF1A168











1-100-08-2-2	
1-210-08-2-2	
1-230-08-2-2	
2485	
2487	
319	
268	
3740-100, 3740-150	
5515T	
782-U	

7865	
KB18-01	
KSBG18-10DISPEN	

Conjunto de ferramentas de corte, chaves de impacto e limas 3/3 Fit&Go - 13 peças







FF1A169			
	€		
35 x 445 x 543 mm	271,48	1	FF1A169

2681	
3625W-28	
3733-4	
3734-3, 3734-4, 3734-6	
3735-5-120	
481-400	
BB10	
BE66152	
BT10P330	
MA321	
MTB-3-16	

Conjunto de chaves de caixa de cabeça dupla em inserção de espuma 3/3 Fit&Go - 14 peças













FF1A170			
	€		
40 x 445 x 543 mm	286,44	1	FF1A170

28M-16, 28M-15, 28M-18, 28M-17, 28M-12, 28M-11, 28M-14, 28M-13, 28M-24, 28M-19, 28M-22, 28M-8, 28M-10, 28M-9	
--	---

FF1A18-26 peças

















FF1A18			
	€		
44 x 445 x 543 mm	324,00	1	FF1A18

1-476-04-3-2	
2633/S4	
3734S/6	
3736S/6	
481-200, 481-500	
782-U	
3625N-32	

Fit&Go 3/3 Espuma de embutir, cortar e alicate - 15 peças

















FF1A185			
	€		
40 x 445 x 543 mm	180,25	1	FF1A185

3734S/6-T	
479-16	
3625W-35	
KB18-01	
KSBG18-10DISPEN	
2101G-180IP	
2470 G-200	
2678 G-180	
8224 IP	
2530	

Conjunto de alicates, ferramentas de corte, martelos e pinça de recolha em inserção de espuma 3/3 Fit&Go - 25 peças









FF1A189			
	€		
40 x 445 x 543 mm	234,88	1	FF1A189

3734S/6	
479-16	
3625W-35	
MTG-3-16	
KB18-01	
KSBG18-10DISPEN	
2101G-180IPD	
2630GC-180IP	
2470 G-200	
8224 IP	
2530	

FF1A19-33 peças



FF1A19			
	€		
50 x 543 x 445 mm	453,17	1	FF1A19

111M-30, 111M-32, 111M-6, 111M-7, 111M-8, 111M-9, 111M-10, 111M-11, 111M-12, 111M-13, 111M-14, 111M-15, 111M-16, 111M-17, 111M-18, 111M-19, 111M-20, 111M-21, 111M-22, 111M-24, 111M-27	
6M-6-7, 6M-8-9, 6M-10-11, 6M-12-13, 6M-14-15, 6M-16-17, 6M-18-19, 6M-20-22, 6M-21-23, 6M-24-27, 6M-30-32	
92C	



Conjunto de chaves de caixa 1/2" e 1/4" e chaves dinâmicas em inserção de espuma 3/3 Fit&Go - 51 peças



FF1A194

	€		
40 x 445 x 543 mm	676,01	1	FF1A194

6968	
6700SM-14, 6700SM-13, 6700SM-12, 6700SM-11, 6700SM-10, 6700SM-9, 6700SM-8, 6700SM-7, 6700SM-6, 6700SM-5, 6700SM-4	
6709M-3, 6709M-8, 6709M-6, 6709M-5, 6709M-4	
6950SL	
7800SM-24, 7800SM-23, 7800SM-22, 7800SM-13, 7800SM-12, 7800SM-11, 7800SM-10, 7800SM-9, 7800SM-8, 7800SM-21, 7800SM-19, 7800SM-18, 7800SM-17, 7800SM-16, 7800SM-15, 7800SM-14	
7809M-8, 7809M-7, 7809M-10, 7809M-6, 7809M-5	
7809TORX-T20, 7809TORX-T25, 7809TORX-T30, 7809TORX-T40	
7455-200	
8150SL	
8168	
K6650-1/4-1P	
6960W-2, 6960W-6	
8160-10, 8160-5	

FF1A20-18 peças



FF1A20

	€		
50 x 445 x 543 mm	509,67	1	FF1A20

2M-6-7, 2M-8-9, 2M-10-11, 2M-12-13, 2M-14-15, 2M-16-17, 2M-18-19, 2M-20-22, 2M-21-23, 2M-24-27, 2M-30-32

4040M-10-11, 4040M-12-13, 4040M-14-15, 4040M-16-17, 4040M-18-19, 4040M-21-23

2953-250

FF1A22-58 peças



FF1A22

	€		
50 x 445 x 543 mm	837,70	1	FF1A22

7800SM-10, 7800SM-12, 7800SM-13, 7800SM-14, 7800SM-16, 7800SM-17, 7800SM-18, 7800SM-19, 7800SM-21, 7800SM-22, 7800SM-23, 7800SM-24, 7800SM-27, 7800SM-30, 7800SM-32

7805SM-13, 7805SM-16, 7805SM-17, 7805SM-18, 7805SM-19, 7805SM-21, 7805SM-22, 7805SM-24, 7805SM-27, 7805SM-30, 7805SM-32

7809M-5, 7809M-6, 7809M-8, 7809M-10, 7809M-12, 7809M-14

8150SL

6700SM-4, 6700SM-4.5, 6700SM-5, 6700SM-5.5, 6700SM-6, 6700SM-7, 6700SM-8, 6700SM-9, 6700SM-10, 6700SM-11, 6700SM-12, 6700SM-13

6958

6954

6960, 6962

6966

6950SL

4532-A

8157-15

8154-11

8160-3, 8160-5

8166

FF1A23-21 peças



FF1A23

	€		
40 x 445 x 543 mm	464,30	1	FF1A23

3735-4-120

3734-2, 3734-3, 3734-4, 3734-5, 3734-6, 3734-8

2630GC-180IP

2430 GC-200 IP

2427 GC-200IP

2900-180

2890-180

2990-180

2800-180

7224

2101GC-160IP

479-16

1547

MTB-3-16

SC127

3625N-32

Conjunto de chaves de parafusos e alicates para anéis de retenção em inserção de espuma 3/3 Fit&Go - 17 peças



FF1A230

	€		
40 x 445 x 543 mm	510,82	1	FF1A230

1RM-9, 1RM-8, 1RM-11, 1RM-10, 1RM-13, 1RM-12, 1RM-15, 1RM-14, 1RM-17, 1RM-16, 1RM-19, 1RM-18

28-29/S4

8072 C

FF1A2301-26 peças



FF1A2301

	€		
70 x 445 x 543 mm	799,75	1	FF1A2301

8900DM-19, 8900DM-22, 8900DM-23, 8900DM-24, 8900DM-25, 8900DM-26, 8900DM-27, 8900DM-28, 8900DM-29, 8900DM-30, 8900DM-32, 8900DM-33, 8900DM-34, 8900DM-36, 8900DM-41, 8900DM-46, 8900DM-50, 8900DM-55, 8900DM-60		
8954		
8954A		
8958A		
8961		
8965		
8966		
8955N/B		

Fit&Go 3/3 Espuma marcada a laser com encaixe para ficha automóvel - 31 peças



FF1A235

	kg	€		
50 x 445 x 543 mm	4.10 kg	430,73	1	FF1A235

BE61110	
BE621702, BE621703, BE621701, BE621706, BE621707, BE621704, BE621705, BE621710, BE621711, BE621708, BE621709, BE621714, BE621715, BE621712, BE621713, BE621716, BE621717	
BE6810	
2M-6-7, 2M-8-9, 2M-12-13, 2M-18-19, 2M-16-17, 2M-10-11, 2M-14-15, 2M-24-26, 2M-21-23, 2M-27-29, 2M-20-22, 2M-30-32	

Fit&Go 3/3 Espuma Marcada a Laser para Carroçaria Automóvel - 13 peças



FF1A236

	kg	€		
55 x 445 x 543 mm	9.5 kg	453,20	1	FF1A236

3-330-14-2-0		
9-462-14-0-0		
1467-250		
BBSH2F		
BBSH2CA		
BBSDW		
BBSDA		
BBSDT		
BBSDH		
BBSDC		
BBSDHR		
BBSS1		
2485		

FF1A24-19 peças



FF1A24

	€		
45 x 445 x 543 mm	411,12	1	FF1A24

3735-4-120	
3734-2, 3734-3, 3734-4, 3734-5, 3734-6, 3734-8	
2630GC-180IP	

2430 GC-200 IP	
2900-180	
2890-180	
2990-180	
2800-180	
7224	
2101GC-160IP	
479-16	
3625N-32	
MTB-3-16	
SC127	

FF1A25-50 peças



FF1A25

	€		
50 x 445 x 543 mm	649,66	1	FF1A25

7800SM-10, 7800SM-12, 7800SM-13, 7800SM-14, 7800SM-15, 7800SM-16, 7800SM-17, 7800SM-18, 7800SM-19, 7800SM-21, 7800SM-22, 7800SM-23, 7800SM-24, 7800SM-27, 7800SM-30, 7800SM-32		
7805SM-13, 7805SM-16, 7805SM-17, 7805SM-18, 7805SM-19, 7805SM-21, 7805SM-22, 7805SM-24, 7805SM-27, 7805SM-30, 7805SM-32		
8150SL		
6700SM-4, 6700SM-4.5, 6700SM-5, 6700SM-5.5, 6700SM-6, 6700SM-7, 6700SM-8, 6700SM-9, 6700SM-10, 6700SM-11, 6700SM-12, 6700SM-13		
6954		
6960, 6962		
6966		
6950SL		
2953-250		
8166		
8154-11		
8160-3, 8160-5		



FF1A2501-83 peças



FF1A2501



	€		
50 x 445 x 543 mm	976,78	1	FF1A2501

6700SM-4, 6700SM-5, 6700SM-5.5, 6700SM-6, 6700SM-7, 6700SM-8, 6700SM-9, 6700SM-10, 6700SM-11, 6700SM-12, 6700SM-13		
6700TORX-E8, 6700TORX-E10		
6709M-3, 6709M-4, 6709M-5, 6709M-6, 6709M-8		
6709TORX-T8, 6709TORX-T10, 6709TORX-T15, 6709TORX-T20, 6709TORX-T25, 6709TORX-T27, 6709TORX-T30, 6709TORX-T40		
6950SL		
6954		
6956		
6962		
6966		
7400SM-8, 7400SM-9, 7400SM-10, 7400SM-11, 7400SM-12, 7400SM-13, 7400SM-14, 7400SM-15, 7400SM-16, 7400SM-17, 7400SM-18, 7400SM-19, 7400SM-20, 7400SM-21, 7400SM-22		
7400TORX-E8, 7400TORX-E10, 7400TORX-E12, 7400TORX-E14		
7750SL		
7754		
7762		
7764		
7765		
7766		
7768		
7800SM-13, 7800SM-17, 7800SM-12, 7800SM-18, 7800SM-19, 7800SM-20, 7800SM-27, 7800SM-30, 7800SM-32, 7800SM-21, 7800SM-22, 7800SM-24		
7809M-12, 7809M-10		
7809TORX-T20, 7809TORX-T25, 7809TORX-T40, 7809TORX-T50, 7809TORX-T55		
8150SL		
8164-1/2		
8154-11		
8160-10		
8171		
8166		
8172		

Chaves de caixa 1/2-3/8, 101 peças



FF1A2503



	€		
55 x 445 x 543 mm	681,61	1	FF1A2503

6700SM-4.5, 6700SM-4, 6700SM-5, 6700SM-5.5, 6700SM-6, 6700SM-7, 6700SM-8, 6700SM-9, 6700SM-10, 6700SM-11, 6700SM-12, 6700SM-13, 6700SM-14		
7800SM-10, 7800SM-11, 7800SM-12, 7800SM-13, 7800SM-14, 7800SM-15, 7800SM-18, 7800SM-19, 7800SM-21, 7800SM-22, 7800SM-23, 7800SM-24, 7800SM-30, 7800SM-26, 7800SM-27, 7800SM-28, 7800SM-32, 7800SM-16, 7800SM-17, 7800SM-8, 7800SM-9		
BE-9678		
7809M-10, 7809M-12, 7809M-14, 7809M-17, 7809M-19, 7809M-5, 7809M-7, 7809M-8, 7809M-9, 7809M-6		
59S/31-1		
7809M-10-140, 7809M-5-180, 7809M-6-140, 7809M-7-100, 7809M-8-120		
808050		
8155-1/2		
6950		
6954		
6956		
6960, 6962		
6966		
8154-11		
8160-5, 8160-10		
8166		

FF1A26-27 peças



FF1A26



	€		
50 x 445 x 543 mm	469,64	1	FF1A26

111M-30, 111M-32, 111M-6, 111M-7, 111M-8, 111M-9, 111M-10, 111M-11, 111M-12, 111M-13, 111M-14, 111M-15, 111M-16, 111M-17, 111M-18, 111M-19, 111M-20, 111M-21, 111M-22, 111M-24, 111M-27		
2630GC-180IP		
2430 GC-200 IP		
7224		
2953-250		
2101GC-160IP		
SC127		

FF1A28-48 peças



FF1A28



	€		
50 x 445 x 543 mm	550,46	1	FF1A28

7800SM-18, 7800SM-19, 7800SM-21, 7800SM-22, 7800SM-23, 7800SM-24, 7800SM-27, 7800SM-30, 7800SM-32, 7800SM-10, 7800SM-12, 7800SM-13, 7800SM-14, 7800SM-15, 7800SM-16, 7800SM-17		
8150SL		
6700SM-4.5, 6700SM-5, 6700SM-5.5, 6700SM-6, 6700SM-7, 6700SM-8, 6700SM-9, 6700SM-10, 6700SM-11, 6700SM-12, 6700SM-13, 6700SM-4		
6954		
6960, 6962		
6966		
6950SL		
3735-4-120		
3734-2, 3734-3, 3734-4, 3734-5, 3734-6, 3734-8		
479-16		
MTB-3-16		
3625N-32		
8154-11		
8160-3, 8160-5		
8166		

Conjunto de chaves de caixa, chaves de boca e aperto e alicates em inserção de espuma marcada a laser 3/3 Fit&Go - 45 peças



FF1A29NB

		€		
50 x 445 x 543 mm	6.26 kg	315,27	1	FF1A29NB

111M-6, 111M-7, 111M-8, 111M-9, 111M-13, 111M-12, 111M-11, 111M-10, 111M-24, 111M-22, 111M-17, 111M-16, 111M-15, 111M-14, 111M-21, 111M-19, 111M-18

8071 IP

2470 G-160

2971G-250

2171G-160

8150SL

SBS83-10, SBS83-5

SBS87S

SBS85

SP16SLH

7800SM-27, 7800SM-22, 7800SM-23, 7800SM-24, 7800SM-18, 7800SM-19, 7800SM-20, 7800SM-21, 7800SM-14, 7800SM-15, 7800SM-16, 7800SM-17, 7800SM-10, 7800SM-11, 7800SM-12, 7800SM-13, 7800SM-30, 7800SM-32

FF1A3001-21 peças



FF1A3001

	€		
40 x 445 x 543 mm	273,92	1	FF1A3001

111M-32, 111M-30, 111M-24, 111M-22, 111M-27, 111M-17, 111M-16, 111M-15, 111M-14, 111M-21, 111M-20, 111M-19, 111M-18, 111M-9, 111M-8, 111M-7, 111M-6, 111M-13, 111M-12, 111M-11, 111M-10

FF1A3002-7 peças



FF1A3002

	€		
35 x 445 x 543 mm	347,33	1	FF1A3002

1RM-24, 1RM-22, 1RM-21, 1RM-19, 1RM-32, 1RM-30, 1RM-27

FF1A3003-28 peças



FF1A3003

	€		
40 x 445 x 543 mm	307,69	1	FF1A3003

1952M-27, 1952M-21, 1952M-20, 1952M-19, 1952M-18, 1952M-24, 1952M-22, 1952M-13, 1952M-12, 1952M-11, 1952M-10, 1952M-17, 1952M-16, 1952M-15, 1952M-14, 1952M-9, 1952M-8, 1952M-7, 1952M-6

BE-9778

FF1A3004-30 peças



FF1A3004

	€		
48 x 445 x 543 mm	535,81	1	FF1A3004

111M-24, 111M-22, 111M-17, 111M-16, 111M-15, 111M-14, 111M-21, 111M-20, 111M-19, 111M-18, 111M-9, 111M-8, 111M-7, 111M-6, 111M-13, 111M-12, 111M-11, 111M-10

1RM-19, 1RM-10, 1RM-9, 1RM-8, 1RM-14, 1RM-13, 1RM-12, 1RM-11, 1RM-18, 1RM-17, 1RM-16, 1RM-15



FF1A3005-28 peças



FF1A3005

	€		
38 x 445 x 543 mm	569,00	1	FF1A3005

1952M-19, 1952M-18, 1952M-22, 1952M-13, 1952M-12, 1952M-11, 1952M-10, 1952M-17, 1952M-16, 1952M-15, 1952M-14, 1952M-9, 1952M-8, 1952M-7, 1952M-6

1RM-6, 1RM-10, 1RM-9, 1RM-8, 1RM-7, 1RM-24, 1RM-22, 1RM-19, 1RM-14, 1RM-13, 1RM-12, 1RM-11, 1RM-17

Conjunto de chaves de parafusos, chaves de roquete, chaves de caixa e pontas ERGO™ em inserção de espuma marcada a laser 3/3 Fit&Go - 22 peças



FF1A30NB

		€		
35 x 445 x 543 mm	2.8 kg	219,56	1	FF1A30NB

BE-8020, BE-8030, BE-8040

BE-8150, BE-8155

BE-8160

BE-8611, BE-8621

BE-8811, BE-8821

BE-8910, BE-8915, BE-8920, BE-8925, BE-8930

808050S

808050

6972H

K6650-1/4-1P

6950SL

59S/31-1

SBS64

SB6963

SBS60-4, SBS60-11, SBS60-12, SBS60-13, SBS60-7, SBS60-8, SBS60-9, SBS60-10, SBS60-4.5, SBS60-5, SBS60-5.5, SBS60-6



Conjunto de martelo, ferramentas de corte, limas e chaves em L em inserção de espuma marcada a laser 3/3 Fit&Go - 28 peças



FF1A31NB

		€		
45 x 445 x 543 mm	2.69 kg	123,89	1	FF1A31NB

317	
1-100-08-1-2	
1-210-08-1-2	
1-230-08-1-2	
MTB-3-16	
3625W-35	
481-300	
782-U	
BE-9770	
KG09-01	
KSBG09-10DISPEN	

Ferramentas de impacto e limas, 24 peças. Ferramentas de impacto e limas, 24 peças



FF1A35

	€		
42 x 445 x 543 mm	365,92	1	FF1A35

317	
1-100-08-1-2	
1-210-08-1-2	
1-230-08-1-2	
MTB-3-16	
3625W-35	
481-300	
782-U	
BE-9770	
KG09-01	
4040M-8-9, 4040M-10-11, 4040M-12-13, 4040M-14-15, 4040M-16-17	

Chaves de parafusos, bits e chaves de caixa, 89 peças



FF1A36

	€		
50 x 445 x 543 mm	483,95	1	FF1A36

4040M-8-9, 4040M-10-11, 4040M-12-13, 4040M-14-15, 4040M-16-17	
808050S	
808050	
6972H	
K6650-1/4-1P, 59S/H8	
6950SL	
59S/31-1	
59S/H2, 59S/H3, 59S/H4, 59S/H5, 59S/H6	
8030-2P, 8040-2P, 8242-2P, 8252-2P	
8610-2P, 8620-2P, 8630-2P	
8810-2P, 8820-2P, 8830-2P	
8910-2P, 8915-2P, 8925-2P, 8930-2P, 8940-2P	
BE-8575	
SBS60-11, SBS60-12, SBS60-13, SBS60-4, SBS60-4.5, SBS60-5, SBS60-5.5, SBS60-6, SBS60-7, SBS60-8, SBS60-9, SBS60-10	
SB6963	
SBS64	

FF1A37, 46 peças. Chaves de caixa e chaves, 46 peças



FF1A37

	€		
35 x 445 x 543 mm	352,93	1	FF1A37

111M-6, 111M-7, 111M-8, 111M-9, 111M-10, 111M-11, 111M-12, 111M-13, 111M-14, 111M-15, 111M-16, 111M-17, 111M-18, 111M-19, 111M-21, 111M-22, 111M-24	
8071 IP	
2101G-160	
2430 G-160	
8224	
S240NB-NR	
8150SL	

FF1A39, 54 peças. Chaves de caixa e chaves, 54 peças



FF1A39

	€		
45 x 445 x 543 mm	299,81	1	FF1A39

S410	
S1612L	
8071 IP	

FF1A4001-12 peças



FF1A4001

	€		
38 x 445 x 543 mm	432,70	1	FF1A4001

1520 D	
2101G-160IP	
21HDG-200IP	
2223 G-150	

2421 G-140IP, 2421 G-180 IP	
2427 G-200 IP	
2628 G-180IP	
2681	
2951-140, 2951-300	
8224 IP	

FF1A4002-11 peças



FF1A4002

	€		
42 x 445 x 543 mm	388,55	1	FF1A4002

2101G-160IP	
2430 G-200 IP	
2465D-200	
2628 G-160IP	
2744	
2951-140	
2952-165	
1520 G	
527 D-160	
7224	
5515FL	

FF1A4003-12 peças



FF1A4003

	€		
35 x 445 x 543 mm	316,48	1	FF1A4003

2800-150, 2800-180, 2800-225	
2890-140, 2890-180, 2890-210	
2900-150, 2900-180, 2900-215	
2990-140, 2990-180, 2990-200	

FF1A41, 9 peças. Ferramentas de impacto e serras, 9 peças



FF1A41

	€		
42 x 445 x 543 mm	138,11	1	FF1A41

2171G-160	
2470 G-160	
2971G-250	
MTB-3-16	
WR2-12	
3625W-35	
481-300	
218	
306	

Conjunto de chaves em inserção de espuma 3/3 Fit&Go - 31 peças



FF1A48

	€		
44 x 543 x 445 mm	371,53	1	FF1A48

1RM-6, 1RM-7, 1RM-8, 1RM-9, 1RM-10, 1RM-11, 1RM-12, 1RM-13, 1RM-14, 1RM-17, 1RM-19, 1RM-22, 1RM-24, 1RM-27	
111M-6, 111M-7, 111M-8, 111M-9, 111M-10, 111M-11, 111M-12, 111M-13, 111M-14, 111M-15, 111M-16, 111M-17, 111M-18, 111M-19, 111M-20, 111M-21, 111M-22	

FF1A50-13 peças. Alicates: corte, alicate de bomba de água e chaves ajustáveis



FF1A50

	€		
45 x 445 x 543 mm	529,17	1	FF1A50

8223 IP, 8224 IP, 8225 IP	
1420	
2430 G-160 IP	
2427 G-160 IP	
8069	
9070	
9031	
2101G-160IP	
21HDG-180IP	

FF1A5002-27 peças



FF1A5002

	€		
50 x 445 x 543 mm	327,41	1	FF1A5002

111M-30, 111M-32, 111M-6, 111M-7, 111M-8, 111M-9, 111M-10, 111M-11, 111M-12, 111M-13, 111M-14, 111M-15, 111M-16, 111M-17, 111M-18, 111M-19, 111M-20, 111M-21, 111M-22, 111M-24, 111M-27	
3734S/6	



FF1A5003-91 peças



FF1A5003

45 x 445 x 543 mm 1.033,05 1 FF1A5003

111M-13, 111M-12, 111M-10, 111M-8, 111M-19, 111M-17, 111M-15	
6700SM-5.5, 6700SM-5, 6700SM-14, 6700SM-13, 6700SM-12, 6700SM-11, 6700SM-10, 6700SM-9, 6700SM-8, 6700SM-7, 6700SM-6	
6700TORX-E5, 6700TORX-E4, 6700TORX-E10, 6700TORX-E8, 6700TORX-E7, 6700TORX-E6	
6709TORX-T27, 6709TORX-T25, 6709TORX-T20, 6709TORX-T15, 6709TORX-T10, 6709TORX-T9, 6709TORX-T8, 6709TORX-T40, 6709TORX-T30	
6950	
6961, 6962	
6966	
7400SM-13, 7400SM-12, 7400SM-11, 7400SM-10, 7400SM-9, 7400SM-8, 7400SM-21, 7400SM-19, 7400SM-18, 7400SM-17, 7400SM-16, 7400SM-15, 7400SM-14, 7400SM-22	
7400TORX-E18, 7400TORX-E16, 7400TORX-E14, 7400TORX-E12, 7400TORX-E11, 7400TORX-E10, 7400TORX-E8	
7409TORX-T30, 7409TORX-T27, 7409TORX-T25, 7409TORX-T50, 7409TORX-T45, 7409TORX-T40	
7750	
7760, 7761, 7762	
7764	
7765	
7766	
A6800DM-8, A6800DM-7, A6800DM-6, A6800DM-14, A6800DM-13, A6800DM-12, A6800DM-11, A6800DM-10, A6800DM-9	
A7402DM-19, A7402DM-18, A7402DM-17, A7402DM-16, A7402DM-15, A7402DM-14, A7402DM-13, A7402DM-12, A7402DM-11, A7402DM-10	
8157-15	

FF1A5004-37 peças



FF1A5004

55 x 445 x 543 mm 734,96 1 FF1A5004

1RM-19, 1RM-13, 1RM-12, 1RM-11, 1RM-10, 1RM-9, 1RM-8, 1RM-27, 1RM-7, 1RM-24, 1RM-6, 1RM-22, 1RM-17	
6700SM-13, 6700SM-12, 6700SM-11, 6700SM-10, 6700SM-9, 6700SM-8, 6700SM-7, 6700SM-6	
6950	
6960	
6966	
7800SM-19, 7800SM-17, 7800SM-32, 7800SM-30, 7800SM-13, 7800SM-27, 7800SM-24, 7800SM-22	
8155-1/2	
SBS86	
6954	
8160-5	
8166	

FF1A5005-83 peças



FF1A5005

50 x 445 x 543 mm 1.019,46 1 FF1A5005

111M-17, 111M-15, 111M-13, 111M-19, 111M-8	
6700SM-8, 6700SM-7, 6700SM-6, 6700SM-12, 6700SM-11, 6700SM-10, 6700SM-9, 6700SM-14, 6700SM-13, 6700SM-5, 6700SM-4	
6709M-5, 6709M-4, 6709M-8, 6709M-6, 6709M-3	

6950SL	
6962	
6968	
7400SM-8, 7400SM-7, 7400SM-6, 7400SM-12, 7400SM-11, 7400SM-10, 7400SM-9, 7400SM-16, 7400SM-15, 7400SM-14, 7400SM-13, 7400SM-18, 7400SM-17	
7750SL	
7760-W	
7761	
7768	
7800SM-11, 7800SM-10, 7800SM-15, 7800SM-14, 7800SM-13, 7800SM-12, 7800SM-19, 7800SM-18, 7800SM-17, 7800SM-16, 7800SM-22, 7800SM-21, 7800SM-27, 7800SM-24, 7800SM-32, 7800SM-30, 7800SM-8, 7800SM-9	
7809M-17, 7809M-14, 7809M-12, 7809M-10, 7809M-5, 7809M-6, 7809M-7, 7809M-8	
7809TORX-T40, 7809TORX-T30, 7809TORX-T25, 7809TORX-T20, 7809TORX-T45	
8150SL	
A6709M-6, A6709M-5, A6709M-4, A6709M-3, A6709M-2.5	
K6650-1/4-1P	
6960W-2, 6960W-6	
8160-5, 8160-10	
8166	

FF1A5006-27 peças



FF1A5006

54 x 445 x 543 mm 496,69 1 FF1A5006

1-100-08-2-2	
1-210-08-2-2	
1-230-06-2-2, 1-230-10-2-2	
111M-7, 111M-8, 111M-9, 111M-10, 111M-11, 111M-12, 111M-13, 111M-14, 111M-15, 111M-16, 111M-17, 111M-18, 111M-19, 111M-21, 111M-22	
1320RM-6-7, 1320RM-8-9, 1320RM-10-11, 1320RM-12-13, 1320RM-14-15, 1320RM-16-17, 1320RM-18-19, 1320RM-22-24	

FF1A5007-60 peças



FF1A5007

	€		
50 x 445 x 543 mm	746,21	1	FF1A5007

K6650-1/4-1P	
3734-2, 3734-3, 3734-4, 3734-5, 3734-6, 3734-8	
481-400	
6700SM-11, 6700SM-12, 6700SM-13, 6700SM-14, 6700SM-10, 6700SM-5, 6700SM-6, 6700SM-7, 6700SM-8, 6700SM-9, 6700SM-4	
6709F-8, 6709F-5.5	
6709M-3, 6709M-4, 6709M-5, 6709M-6	
6709PH-1, 6709PH-2	
6950SL	
6954	
6960, 6962	
6966	
7800SM-18, 7800SM-19, 7800SM-10, 7800SM-11, 7800SM-12, 7800SM-13, 7800SM-14, 7800SM-15, 7800SM-16, 7800SM-17, 7800SM-21, 7800SM-22, 7800SM-23, 7800SM-24, 7800SM-25, 7800SM-26, 7800SM-27, 7800SM-28, 7800SM-30, 7800SM-32	
8072 IP	
B145.006.100	
8150SL	
8224 IP	
8154-11	
8160-5, 8160-10	
8166	

FF1A5008-24 peças



FF1A5008

	€		
50 x 445 x 543 mm	548,85	1	FF1A5008

1-100-08-2-2	
1-160-08-2-2	

1-170-08-2-2	
1-210-08-2-2	
1-230-08-2-2	
1150D	
1450D-ISO	
1547	
3625N-40	
3734-2, 3734-3, 3734-4, 3734-5, 3734-6, 3734-8	
3735-4-120, 3735-5-150	
3740-125, 3740-150	
38-20	
5515T	
9029, 9031	
MTB-3-16	

FF1A5009-17 peças



FF1A5009

	€		
38 x 445 x 543 mm	484,84	1	FF1A5009

2101S-160		1000 V RECHARGE
2223 S-150		1000 V RECHARGE
2250V-170		1000 V RECHARGE
2430 S-200		1000 V RECHARGE
2628 S-180		1000 V RECHARGE
8072V		1000 V RECHARGE
BE-8220S, BE-8040S, BE-8050S, BE-8255S, BE-8065S		
BE-8340		
BE-8601		
BE-8610S, BE-8620S		
BE-8810S, BE-8820S		

FF1A5010-22 peças



FF1A5010

	€		
35 x 445 x 543 mm	348,10	1	FF1A5010

1-100-08-1-2	
1-160-08-1-2	
1-170-08-2-2	
1-210-08-1-2	
1-230-08-1-2	
2101G-180IP	
2427 G-200 IP	
2430 G-200 IP	
2628 G-180IP	
3733-2, 3733-4, 3733-6	
3734-2, 3734-3, 3734-4, 3734-5, 3734-6, 3734-8	
3735-4-120	
481-300	
8069 IP	
9031	

FF1A5011-27 peças



FF1A5011

	€		
44 x 445 x 543 mm	349,69	1	FF1A5011

1-476-04-3-2	
1178-SCRIBE	
1547	
2101G-160IP	
2427 G-160 IP	
2430 G-160 IP	
3734-2, 3734-3, 3734-4, 3734-5, 3734-6, 3734-8	
3735-5-120	
481-500	
BE-8020L, BE-8040	
BE-8150, BE-8255, BE-8256	
BE-8610, BE-8620	
MTB-3-16	



FF1A5012-13 peças



FF1A5012

48 x 445 x 543 mm € 270,27 1 FF1A5012

- 141
- 3734-2, 3734-3, 3734-4, 3734-5, 3734-6
- 479-08
- 481-1000, 481-300
- 782-U
- MTS-5-25
- SQZ150003
- 319

FF1A5013-41 peças



FF1A5013

50 x 445 x 543 mm € 538,18 1 FF1A5013

- 111M-6, 111M-7, 111M-8, 111M-9, 111M-12, 111M-13, 111M-17, 111M-10, 111M-11, 111M-19, 111M-20, 111M-22, 111M-24, 111M-27, 111M-32, 111M-30
- 6700SM-6, 6700SM-7, 6700SM-8, 6700SM-9, 6700SM-10, 6700SM-11, 6700SM-12, 6700SM-13, 6700SM-14
- 6950
- 6960
- 6966
- 7800SM-19, 7800SM-17, 7800SM-13, 7800SM-22, 7800SM-27, 7800SM-24, 7800SM-30, 7800SM-32
- 8155-1/2
- SBS86
- 6954
- 8160-5
- 8166

FF1A5015, 17 peças



FF1A5015

45 x 445 x 543 mm € 237,08 1 FF1A5015

- 319
- 268
- 208
- 2509
- 2444
- 2744
- 5515T
- BE-8020L, BE-8040
- BE-8150, BE-8255, BE-8256
- BE-8340
- BE-8601
- BE-8610, BE-8620
- MTB-5-25

FF1A5017, 16 peças



FF1A5017

35 x 445 x 543 mm € 233,63 1 FF1A5017

- 3734-2, 3734-3, 3734-4, 3734-5, 3734-6, 3734-8
- 3735-5-120
- 3740-175
- 481-400
- 111M-21, 111M-22, 111M-24, 111M-27, 111M-32, 111M-30
- 3625N-32

FF1A5019-47 peças



FF1A5019

52 x 445 x 543 mm € 592,70 1 FF1A5019

- 111M-17, 111M-18, 111M-19, 111M-20, 111M-6, 111M-7, 111M-8, 111M-13, 111M-14, 111M-15, 111M-16, 111M-9, 111M-10, 111M-11, 111M-12
- 2101G-160IP
- 2430 G-160 IP
- 2628 G-180IP
- 7800DM-12, 7800DM-13, 7800DM-14, 7800DM-15, 7800DM-10, 7800DM-11, 7800DM-20, 7800DM-21, 7800DM-22, 7800DM-23, 7800DM-16, 7800DM-17, 7800DM-18, 7800DM-19, 7800DM-28, 7800DM-30, 7800DM-32, 7800DM-24, 7800DM-25, 7800DM-26, 7800DM-27, 7800DM-8, 7800DM-9
- 8155-1/2
- 8224 IP
- 8154-11
- 8160-5, 8160-10
- 8166

FF1A5021-17 peças



FF1A5021

45 x 445 x 543 mm € 293,28 1 FF1A5021

BE-8020L, BE-8040		
BE-8150, BE-8255, BE-8256		
BE-8340		
BE-8601		
BE-8610, BE-8620		
319		
MTB-5-25		
2444		
268		
5515T		
2509		
2744		
208		

FF1A5022-26 peças



FF1A5022

	€		
50 x 445 x 543 mm	416,54	1	FF1A5022

6700SM-4.5, 6700SM-5, 6700SM-5.5, 6700SM-6, 6700SM-7, 6700SM-8, 6700SM-9, 6700SM-10, 6700SM-11, 6700SM-12, 6700SM-13, 6700SM-14, 6700SM-4		
6950		
6954		
6956		
6960, 6962		
6966		
8070		
9031		
9072 P		
141		
2101G-160IP		
2430 G-160 IP		
2628 G-180IP		
8224 IP		

FF1A5023-16 peças



FF1A5023

	€		
45 x 445 x 543 mm	274,87	1	FF1A5023

208		
2444		
2509		
268		
2744		
319		
5515T		
BE-8020L, BE-8040		
BE-8150, BE-8255, BE-8256		
BE-8340		
BE-8601		
BE-8610, BE-8620		

FF1A5024-28 peças



FF1A5024

	€		
45 x 445 x 543 mm	635,55	1	FF1A5024

111M-12, 111M-13, 111M-6, 111M-7, 111M-8, 111M-9, 111M-10, 111M-11		
1RM-17, 1RM-18, 1RM-19, 1RM-8, 1RM-9, 1RM-10, 1RM-11, 1RM-12, 1RM-13, 1RM-14, 1RM-15, 1RM-16		
2101G-160IP		
2430 G-160 IP		
141		
2628 G-180IP		
9031		

9072 P

8070

8224 IP



FF1A5027, 36 peças



FF1A5027

	€		
44 x 445 x 543 mm	770,51	1	FF1A5027

2M-20-22, 2M-21-23, 2M-24-27, 2M-25-28, 2M-30-32		
4040M-10-11, 4040M-12-13, 4040M-14-15, 4040M-16-17, 4040M-18-19, 4040M-20-22, 4040M-21-23, 4040M-8-9		
7400SM-6, 7400SM-7, 7400SM-12, 7400SM-13, 7400SM-14, 7400SM-15, 7400SM-8, 7400SM-9, 7400SM-10, 7400SM-11, 7400SM-20, 7400SM-21, 7400SM-22, 7400SM-16, 7400SM-17, 7400SM-18, 7400SM-19		
7754		
7755-3/8		
7760, 7761, 7762		
7766		

FF1A5028, 33 peças



FF1A5028

	€		
45 x 445 x 543 mm	266,72	1	FF1A5028

111M-6, 111M-7, 111M-8, 111M-9, 111M-10, 111M-11, 111M-14, 111M-15, 111M-16, 111M-17, 111M-18, 111M-19, 111M-20, 111M-12, 111M-13		
1419-MD		
BE-8906, BE-8907, BE-8908, BE-8909, BE-8910, BE-8915, BE-8920, BE-8925, BE-8927, BE-8930, BE-8940, BE-8945		
7805DM-12, 7805DM-13, 7805DM-17, 7805DM-10, 7805DM-19		



FF1A5029, 29 peças



FF1A5029

	€		
40 x 445 x 543 mm	426,76	1	FF1A5029

2628 G-180IP	
2101G-160IP	
2430 G-160 IP	
8224 IP	
BBR201P6	
BE5103	
2M-10-11, 2M-12-13, 2M-14-15, 2M-16-17, 2M-18-19, 2M-6-7, 2M-8-9	
7809TORX-T50, 7809TORX-T55, 7809TORX-T25, 7809TORX-T30, 7809TORX-T40, 7809TORX-T45	

FF1A5031, 62 peças



FF1A5031

	€		
48 x 445 x 543 mm	343,77	1	FF1A5031

1419-MD	
7809M-10, 7809M-12, 7809M-14, 7809M-17, 7809M-19, 7809M-7, 7809M-8, 7809M-5, 7809M-9, 7809M-6	
BE-9678	
7809M-10-140, 7809M-5-180, 7809M-6-140, 7809M-7-100, 7809M-8-120	
59S/31-1	
808050	
7805DM-12, 7805DM-13, 7805DM-17, 7805DM-19, 7805DM-10	

FF1A5030, 45 peças



FF1A5030

	€		
52 x 445 x 543 mm	563,07	1	FF1A5030

111M-17, 111M-18, 111M-19, 111M-20, 111M-6, 111M-7, 111M-8, 111M-13, 111M-14, 111M-15, 111M-16, 111M-9, 111M-10, 111M-11, 111M-12	
2951-180, 2951-250	
7800DM-12, 7800DM-13, 7800DM-14, 7800DM-15, 7800DM-8, 7800DM-9, 7800DM-10, 7800DM-11, 7800DM-20, 7800DM-21, 7800DM-22, 7800DM-23, 7800DM-16, 7800DM-17, 7800DM-18, 7800DM-19, 7800DM-28, 7800DM-30, 7800DM-32, 7800DM-24, 7800DM-26, 7800DM-27	
8155-1/2	
3625N-32	
8154-11	
8160-5, 8160-10	
8166	

FF1A5032, 76 peças



FF1A5032

	€		
55 x 445 x 543 mm	675,68	1	FF1A5032

6700SM-10, 6700SM-11, 6700SM-8, 6700SM-9, 6700SM-14, 6700SM-12, 6700SM-13, 6700SM-4, 6700SM-6, 6700SM-7, 6700SM-5, 6700SM-4.5, 6700SM-5.5	
6950	
6954	
6956	
6960, 6962	
6966	
7400SM-6, 7400SM-7, 7400SM-10, 7400SM-11, 7400SM-8, 7400SM-9, 7400SM-14, 7400SM-15, 7400SM-12, 7400SM-13, 7400SM-18, 7400SM-19, 7400SM-16, 7400SM-17, 7400SM-22, 7400SM-20, 7400SM-21	
7754	

7755-3/8

7760, 7761, 7762

7766

7800DM-11, 7800DM-14, 7800DM-15, 7800DM-12, 7800DM-13, 7800DM-18, 7800DM-19, 7800DM-16, 7800DM-17, 7800DM-22, 7800DM-23, 7800DM-20, 7800DM-21, 7800DM-26, 7800DM-27, 7800DM-24, 7800DM-30, 7800DM-32, 7800DM-28, 7800DM-8, 7800DM-9, 7800DM-10, 7800DM-25, 7800DM-29

8155-1/2

111M-19, 111M-17, 111M-18, 111M-15, 111M-16, 111M-14, 111M-20

8154-11

8160-5, 8160-10

8166

FF1A5036-6 peças



FF1A5036

	€		
38 x 445 x 543 mm	260,79	1	FF1A5036

BE258

BE250

BE256P3

BE254A

FF1A5037-12 peças



FF1A5037

	€		
75 x 445 x 543 mm	1.524,93	1	FF1A5037

BPC813

BP814A

BP824

BP110

BP118

FF1A5038-50 peças



FF1A5038

	€		
45 x 445 x 543 mm	243,07	1	FF1A5038

BBR300P50

FF1A51-23 peças. Limas, alicate para freios e ferramentas de impacto



FF1A51

	€		
40 x 445 x 543 mm	313,73	1	FF1A51

1-100-08-1-2		
1-210-08-1-2		
1-230-08-1-2		
4-144-08-2-2		
1-170-08-1-2		
3735-4-120		
3733-4, 3733-2, 3733-6		
3734-2, 3734-3, 3734-4, 3734-5, 3734-6, 3734-8		
2800-180, 2800-150		
2890-140, 2890-180		
2900-150, 2900-180		
2990-140, 2990-180		

FF1A53-36 peças. Chaves de parafusos: SL + PH + PZ + TORX e conjunto de bits, alicate para freios e ferramentas de impacto



FF1A53

	€		
45 x 445 x 543 mm	201,57	1	FF1A53

BE-8800, BE-8811, BE-8821		
BE-8830		
BE-8600, BE-8611, BE-8621		
BE-8630		
BE-8910, BE-8915, BE-8920, BE-8925		
BE-9770		
BE-9780		
3625S-44		
2800-225		
2890-210		

FF1A54-75 peças. Chaves de caixa: série longa 1/4" + 3/8"



FF1A54

	€		
35 x 445 x 543 mm	268,99	1	FF1A54

S1612L		
S0810L		
S330L		

FF1A55, 75 peças



FF1A55

	€		
40 x 445 x 543 mm	385,27	1	FF1A55

A6700DZ-1/2, A6700DZ-1/4, A6700DZ-11/32, A6700DZ-3/16, A6700DZ-3/8, A6700DZ-5/16, A6700DZ-7/16, A6700DZ-7/32, A6700DZ-9/16, A6700DZ-9/32		
--	--	--

BE-9775		
SBS61		
SBS63-2, SBS63-6, SBS63-4		
SBS65		
SBS67		
SBS81		
6956		
6972H		
7800DZ-1, 7800DZ-1/2, 7800DZ-11/16, 7800DZ-13/16, 7800DZ-15/16, 7800DZ-19/32, 7800DZ-3/4, 7800DZ-3/8, 7800DZ-5/8, 7800DZ-7/8, 7800DZ-9/16, 7800DZ-7/16		
808050		
6954		
8160-10, 8160-5		
8166		
8154-11		

FF1A56, 28 peças. Chaves boca luneta, 28 peças



FF1A56

	€		
63 x 445 x 543 mm	349,69	1	FF1A56

111Z-1, 111Z-1/2, 111Z-1/4, 111Z-11/16, 111Z-13/16, 111Z-15/16, 111Z-3/4, 111Z-3/8, 111Z-5/16, 111Z-5/8, 111Z-7/16, 111Z-7/8, 111Z-9/16		
1320RZ-1/2-9/16, 1320RZ-1/4-5/16, 1320RZ-3/8-7/16, 1320RZ-5/16-11/32		
6Z-1.1/16-1.1/4, 6Z-1-1.1/8, 6Z-1/2-9/16, 6Z-1/4-5/16, 6Z-15/16-1, 6Z-19/32-11/16, 6Z-25/32-13/16, 6Z-5/16-11/32, 6Z-5/8-3/4, 6Z-7/8-15/16		
9031		



FF1A65-28 peças



FF1A65

	€		
50 x 445 x 543 mm	441,57	1	FF1A65

111M-19, 111M-17, 111M-18, 111M-24, 111M-21, 111M-22, 111M-7, 111M-8, 111M-6, 111M-11, 111M-12, 111M-9, 111M-10, 111M-15, 111M-16, 111M-13, 111M-14, 111M-20	
1RM-8, 1RM-9, 1RM-12, 1RM-13, 1RM-10, 1RM-11, 1RM-17, 1RM-14, 1RM-19	
319	

FF1A66-51 peças



FF1A66

	€		
50 x 445 x 543 mm	304,88	1	FF1A66

038.055.100, 038.065.125, 038.080.150	
039.001.100, 039.002.125	
1178-SCRIBE	
426TOR9	
6972H	
9045-B-250	
BE-8010S, BE-8230S	
BE-8040	
BE-8150, BE-8155	
BE-8800, BE-8811, BE-8821	
BE-8830	
MTB-5-25	
SQZ150003	
59S/31-1	

FF1A67-28 peças



FF1A67

	€		
39 x 445 x 543 mm	377,86	1	FF1A67

9031	
2101G-160IP	
21HDG-180IP	
2427 G-160 IP	
2430 G-160 IP	
8224 IP	
BE-8600, BE-8611, BE-8621	
BE-8630	
BE-8910, BE-8915, BE-8920, BE-8925	
7865	

FF1A68-30 peças



FF1A68

	€		
37 x 445 x 543 mm	266,72	1	FF1A68

1-100-08-1-2	
1-170-08-1-2	
1-210-08-1-2	
1-230-08-1-2	
2800-180	
2890-180	
2900-180	
2990-180	
3733-4, 3733-2, 3733-6	
3734-8, 3734-5, 3734-6, 3734-3, 3734-4, 3734-2	

3735-4-120

4-144-08-2-2

481-400

BE-9770

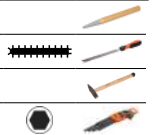

FF1A70-105 peças



FF1A70

	€		
42 x 445 x 543 mm	317,46	1	FF1A70

BE5049	
S560	

FF1A71-46 peças



FF1A71

	€		
41 x 445 x 543 mm	195,60	1	FF1A71

901T-010-100, 901T-015-150, 901T-020-150, 901T-027-150, 901T-030-200, 901T-040-200, 901T-025-150, 901T-045-200, 901T-050-200	
B190.055.125	
B191.030.075, B191.040.100	
B192.001.100, B192.002.125	
B705.1/4.125	
59/S31B	

FF1A72-18 peças



FF1A72

38 x 445 x 543 mm € 347,03 1 FF1A72

2101GC-160IP	
2430 GC-200 IP	
2630GC-180IP	
2800-180	
2890-180	
2900-180	
2953-200	
2990-180	
3640-200-C	
3734N-10-150, 3734N-2-150, 3734N-3-150, 3734N-4-150, 3734N-5-150, 3734N-6-150, 3734N-8-150	
479-16	
3625W-35	

Conjunto de alicates, ferramentas de corte, martelos e fita métrica em inserção de espuma 3/3 Fit&Go - 25 peças



FF1A82

43 x 445 x 543 mm € 194,78 1 FF1A82

3734S/6	
479-16	
3625W-35	
MTG-3-16	
KB18-01	
KSBG18-10DISPEN	
2101G-180IP	
2678 G-180	
2470 G-200	
720031	
8224 IP	

FF1F1001-9 peças



FF1F1001

40 x 362 x 445 mm € 112,60 1 FF1F1001

BE-8210, BE-8030, BE-8040, BE-8240, BE-8242, BE-8252, BE-8250L	
BE-8255, BE-8257	

FF1F1002-11 peças



FF1F1002

40 x 362 x 445 mm € 153,96 1 FF1F1002

BE-8020, BE-8040, BE-8242, BE-8252	
BE-8330	
BE-8256, BE-8258	
BE-8610, BE-8620, BE-8623	
BE-8602	

FF1F1003-11 peças



FF1F1003

38 x 362 x 445 mm € 188,48 1 FF1F1003

BE-8030, BE-8242, BE-8252	
BE-8155	
BE-8870	
BE-8600, BE-8610, BE-8620, BE-8623, BE-8624	
808050S	

FF1F1004-10 peças



FF1F1004

38 x 362 x 445 mm € 139,87 1 FF1F1004

BE-8904, BE-8907, BE-8908	
BE-7910, BE-7915, BE-7920, BE-7925, BE-7927, BE-7930, BE-7940	

FF1F1005-42 peças



FF1F1005

43 x 362 x 445 mm € 220,49 1 FF1F1005

BE-8908, BE-8909, BE-8910, BE-8915, BE-8920, BE-8925, BE-8927, BE-8930	
K6650-1/4-1P	
808050S	
808050	
59S/31-3	



FF1F1006-8 peças



ergo



FF1F1006

40 x 362 x 445 mm € 129,22 1 FF1F1006

BE-8230S, BE-8040S, BE-8050S, BE-8255S



BE-8810S, BE-8820S



BE-8610S, BE-8620S



FF1F1007-7 peças



FF1F1007

35 x 362 x 445 mm € 97,20 1 FF1F1007

901T-010-100, 901T-015-150, 901T-020-150, 901T-025-150, 901T-027-150, 901T-030-200, 901T-040-200



FF1F1008-49 peças



FF1F1008

38 x 362 x 445 mm € 130,40 1 FF1F1008

B219.026



B705.1/4.125



B146.006.100



B145.006.100



BE-9770



59S/31-1

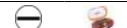

FF1F1009-14 peças



FF1F1009

38 x 362 x 445 mm € 112,60 1 FF1F1009

B219.026



B219.025



B196.030.100



B195.002.025



B195.050.025



FF1F2001-44 peças



FF1F2001

37 x 362 x 445 mm € 451,72 1 FF1F2001

A6800DM-4, A6800DM-5, A6800DM-5.5, A6800DM-6, A6800DM-7, A6800DM-8, A6800DM-9, A6800DM-10, A6800DM-11, A6800DM-12, A6800DM-13



6700SM-5, 6700SM-5.5, 6700SM-6, 6700SM-7, 6700SM-8, 6700SM-9, 6700SM-10, 6700SM-11, 6700SM-12, 6700SM-13, 6700SM-14



6709PH-1, 6709PH-2, 6709PH-3



6709PZ-1, 6709PZ-2



6709M-3, 6709M-4, 6709M-5, 6709M-6, 6709M-8

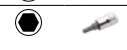

6709F-4.5, 6709F-5.5, 6709F-8

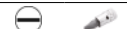

BE-9778



6950SL



7765



6954

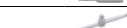

6962



6966



6972H



6956



1998M-12



FF1F2002-53 peças



FF1F2002

45 x 362 x 445 mm € 160,04 1 FF1F2002

SL25L



2058/S26



6956



1419-MD



FF1F2101-36 peças



FF1F2101

37 x 362 x 445 mm € 560,70 1 FF1F2101

7400SM-7, 7400SM-8, 7400SM-9, 7400SM-10, 7400SM-11, 7400SM-12, 7400SM-13, 7400SM-14, 7400SM-15, 7400SM-16, 7400SM-17, 7400SM-18, 7400SM-19, 7400SM-20, 7400SM-21, 7400SM-22



7409M-4, 7409M-6, 7409M-8, 7409M-10



A7402DM-10, A7402DM-11, A7402DM-12, A7402DM-13



A7410DZ-5/16, A7410DZ-7/16, A7410DZ-9/16, A7410DZ-3/8, A7410DZ-5/8



7750SL



7762



7754



7766



7764



8164-1/2



7756



FF1F2102-34 peas



FF1F2102

40 x 362 x 445 mm € 177,81 1 FF1F2102

S330L

FF1F2103-38 peas

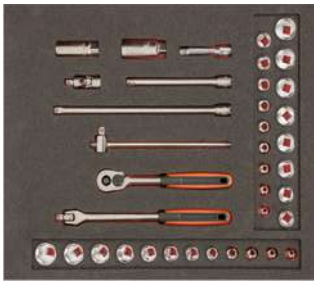

FF1F2103

35 x 362 x 445 mm € 137,49 1 FF1F2103

S380

FF1F2201-35 peas



FF1F2201

50 x 362 x 445 mm € 413,71 1 FF1F2201

7800SM-10, 7800SM-12, 7800SM-13, 7800SM-17, 7800SM-18, 7800SM-19, 7800SM-20, 7800SM-21, 7800SM-22, 7800SM-24, 7800SM-27, 7800SM-30, 7800SM-32

7800DM-10, 7800DM-11, 7800DM-12, 7800DM-13, 7800DM-14, 7800DM-15, 7800DM-16, 7800DM-17, 7800DM-18, 7800DM-19

7809M-5, 7809M-6, 7809M-7, 7809M-8, 7809M-10, 7809M-12

8150SL

8160-5, 8160-10

8166

8154-11

8171

FF1F2202-24 peas



FF1F2202

50 x 362 x 445 mm € 183,74 1 FF1F2202

S240

S81SL

FF1F5004-50 peas



FF1F5004

35 x 362 x 445 mm € 171,89 1 FF1F5004

BE5049

1419-MD

FF1F5013-39 peas



FF1F5013

35 x 362 x 445 mm € 213,11 1 FF1F5013

BS1000

FF1F2203-27 peas



FF1F2203

50 x 362 x 445 mm € 367,47 1 FF1F2203

K7801M-10, K7801M-12, K7801M-13, K7801M-14, K7801M-15, K7801M-16, K7801M-17, K7801M-18, K7801M-19, K7801M-21, K7801M-22, K7801M-24

K7806M-10, K7806M-12, K7806M-13, K7806M-14, K7806M-15, K7806M-16, K7806M-17, K7806M-18, K7806M-19, K7806M-21, K7806M-22, K7806M-24, K7806M-27, K7806M-30, K7806M-32

FF1F3001-11 peas



FF1F3001

40 x 362 x 445 mm € 113,62 1 FF1F3001

6M-6-7, 6M-8-9, 6M-10-11, 6M-12-13, 6M-14-15, 6M-16-18, 6M-17-19, 6M-20-22, 6M-21-23, 6M-24-27, 6M-30-32



FF1F3002-18 peças



FF1F3002

	€		
41 x 362 x 445 mm	198,29	1	FF1F3002

- 111M-6, 111M-7, 111M-8, 111M-9, 111M-10, 111M-11, 111M-12, 111M-13, 111M-14, 111M-15, 111M-16, 111M-17, 111M-18, 111M-19, 111M-21, 111M-22, 111M-24, 111M-27

FF1F3003-30 peças



FF1F3003

	€		
40 x 362 x 445 mm	264,61	1	FF1F3003

- 111M-6, 111M-7, 111M-8, 111M-9, 111M-10, 111M-11, 111M-12, 111M-13, 111M-14, 111M-15, 111M-16, 111M-17, 111M-18, 111M-19, 111M-20, 111M-21, 111M-22

1320SRM-14-19

1RMA-19-1/4-SQ

1RMA-19-1/2-SQ2

1RMA-13-10-BIT

BE-9778

FF1F3004-13 peças



FF1F3004

	€		
42 x 362 x 445 mm	160,04	1	FF1F3004

- 111Z-3/8, 111Z-11/16, 111Z-1, 111Z-1/2, 111Z-13/16, 111Z-5/16, 111Z-5/8, 111Z-15/16, 111Z-7/16, 111Z-3/4, 111Z-1/4, 111Z-9/16, 111Z-7/8

FF1F3005-15 peças



FF1F3005

	€		
39 x 362 x 445 mm	416,08	1	FF1F3005

- 1RM-8, 1RM-10, 1RM-12, 1RM-13, 1RM-14, 1RM-15, 1RM-16, 1RM-17, 1RM-18, 1RM-19, 1RM-21, 1RM-22

1RMA-13-10-BIT

1RMA-19-1/2-SQ2

FF1F3006-7 peças



FF1F3006

	€		
35 x 362 x 445 mm	272,64	1	FF1F3006

- 1RM-19, 1RM-21, 1RM-22, 1RM-24, 1RM-27, 1RM-30

FF1F3007-10 peças



FF1F3007

	€		
47 x 362 x 445 mm	178,93	1	FF1F3007

- 2M-6-7, 2M-8-9, 2M-10-11, 2M-12-13, 2M-14-15, 2M-16-18, 2M-17-19, 2M-21-23, 2M-24-27, 2M-30-32

FF1F3008-9 peças



FF1F3008

	€		
38 x 362 x 445 mm	412,53	1	FF1F3008

- 4040M-6-7, 4040M-8-9, 4040M-10-11, 4040M-12-13, 4040M-14-15, 4040M-16-17, 4040M-18-19, 4040M-20-22, 4040M-21-23

FF1F3009-8 peças



FF1F3009

	€		
35 x 362 x 445 mm	272,64	1	FF1F3009

1949M-8-9, 1949M-10-11, 1949M-12-13, 1949M-14-15, 1949M-17-19, 1949M-19-22, 1949M-24-27, 1949M-30-32



FF1F3010-17 peças



FF1F3010



€



35 x 362 x 445 mm

195,60

1 FF1F3010

1RM/S5



111M/SH12



FF1F3011-13 peças



FF1F3011



€



35 x 362 x 445 mm

201,53

1 FF1F3011

S4RM/3T



111M/SH12



FF1F4001-8 peças



FF1F4001



€



35 x 362 x 445 mm

289,24

1 FF1F4001

2430 G-160 IP



2421 G-180 IP



2101G-160IP



2628 G-200



8224 IP



9029



2951-140, 2951-300



FF1F4002-8 peças



FF1F4002



€



35 x 362 x 445 mm

269,09

1 FF1F4002

2928-160



2951-250



SC127



2101G-160IP



2430 G-160 IP



2339 DIP



2628 G-180IP



8224 IP



FF1F4003-4 peças



FF1F4003



€

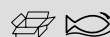

35 x 362 x 445 mm

155,03

1 FF1F4003

2101G-160IP



8224 IP



2951-180



2430 G-200 IP



FF1F4004-8 peças



FF1F4004



€

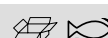

35 x 362 x 445 mm

193,05

1 FF1F4004

2800-140, 2800-180



2890-140, 2890-180



2900-140, 2900-180



2990-140, 2990-180



FF1F4005-5 peças



FF1F4005



€



38 x 362 x 445 mm

218,23

1 FF1F4005

2101S-160



2430 S-200



2427 S-200



8224 IP



2628 S-180



FF1F5001-10 peças



FF1F5001



	€		
40 x 362 x 445 mm	215,25	1	FF1F5001

1-100-08-1-2	
1-160-08-1-2	
1-170-08-1-2	
1-210-08-1-2	
1-230-08-1-2	
2430 G-200 IP	
2628G-200IP	
7224	
2101G-160IP	
MTB-3-16	

FF1F5002-5 peças



FF1F5002



	€		
38 x 362 x 445 mm	130,40	1	FF1F5002

2681	
MA401	
MA411	
1178-SCRIBE	
MTG-5-19	

FF1F5003-5 peças



FF1F5003



	€		
35 x 362 x 445 mm	189,67	1	FF1F5003

8224	
2101G-160	
2430 G-160	
8071	
2951-250	

FF1F5005-8 peças



FF1F5005



	€		
40 x 362 x 445 mm	88,90	1	FF1F5005

317	
3906-300-24-5P	
268	
2446	

FF1F5006-4 peças



FF1F5006



	€		
50 x 362 x 445 mm	325,98	1	FF1F5006

CR W 01	
CR B 05	
3418 A	
BMMTRMS1	

FF1F5007-5 peças



FF1F5007



	€		
45 x 362 x 445 mm	201,53	1	FF1F5007

4543-1, 4543-2, 4543-3	
4545-2	
4541-A	

FF1F5008-11 peças



FF1F5008



	€		
37 x 362 x 445 mm	106,68	1	FF1F5008

2633/S4, 2633L/S4	
2489	
2485	
KE18-01	

FF1F5009-5 peças



FF1F5009

	€		
60 x 362 x 445 mm	243,02	1	FF1F5009

BS618, BS623	
4545-2	
4545-N11	
4532-0	

FF1F5010-9 peças



FF1F5010

	€		
45 x 362 x 445 mm	207,45	1	FF1F5010

BBR6135	
BBR6131	
BBR110	
1949M-8-9, 1949M-10-11	
7809M-6, 7809M-8, 7809M-10	
783	

FF1F5011-7 peças



FF1F5011

	€		
100 x 362 x 445 mm	910,89	1	FF1F5011

BP815	
BP821	
BP822	
BP823	

FF1F5012-9 peças



FF1F5012

	€		
55 x 362 x 445 mm	426,76	1	FF1F5012

BWSS12P317, BWSS12P319, BWSS12P321	
BPC814	
BWTB12P120	
GL008-10	
783	
8157-15	

FF1E1001-7 peças



FF1E1001

	€		
38 x 181 x 445 mm	93,65	1	FF1E1001

BE-8030, BE-8040, BE-8242, BE-8252	
BE-8610, BE-8620, BE-8623	

FF1E1002-7 peças



FF1E1002

	€		
39 x 181 x 445 mm	90,10	1	FF1E1002

BE-8242, BE-8040, BE-8030	
BE-8257, BE-8255	
BE-8611, BE-8621	

FF1E1003-6 peças



FF1E1003

	€		
38 x 181 x 445 mm	85,35	1	FF1E1003

BE-8240	
BE-8150, BE-8255, BE-8256	
BE-8810, BE-8820	

FF1E1004-8 peças



FF1E1004

	€		
40 x 181 x 445 mm	94,83	1	FF1E1004

BE-8340, BE-8350	
BE-8600, BE-8610	
BE-8811, BE-8800, BE-8820L, BE-8821	



FF1E1005-7 peças



ergo



FF1E1005

	€			
40 x 181 x 445 mm	86,54	1	FF1E1005	

BE-8210, BE-8010		
BE-8811, BE-8821, BE-8800		
BE-8600		
BE-8830		

FF1E1006-6 peças



ergo



FF1E1006

	€			
40 x 181 x 445 mm	88,90	1	FF1E1006	

BE-8210		
BE-8610, BE-8620		
BE-8630		
BE-8811, BE-8820		

FF1E1007-6 peças



ergo



FF1E1007

	€			
40 x 181 x 445 mm	77,05	1	FF1E1007	

BE-8910, BE-8915, BE-8920, BE-8925, BE-8930, BE-8940		
--	--	--

FF1E1008-6 peças



ergo



FF1E1008

	€			
38 x 181 x 445 mm	91,28	1	FF1E1008	

BE-7910, BE-7930, BE-7925, BE-7920, BE-7915, BE-7940		
--	--	--

FF1E1009-6 peças



ergo



FF1E1009

	€			
38 x 181 x 445 mm	71,13	1	FF1E1009	

BE-8908, BE-8910, BE-8915, BE-8920, BE-8925, BE-8930		
--	--	--

FF1E1010-6 peças



ergo



FF1E1010

	€			
39 x 181 x 445 mm	86,54	1	FF1E1010	

BE-8010S, BE-8230S, BE-8050S, BE-8255S		
--	--	--

BE-8610S, BE-8620S		
--------------------	--	--

FF1E1011-6 peças



ergo



FF1E1011

	€			
45 x 181 x 445 mm	101,95	1	FF1E1011	

BE-8040S, BE-8050S, BE-8255S, BE-8065S		
--	--	--

BE-8610S, BE-8620S		
--------------------	--	--

FF1E2001-37 peças



FF1E2001

	€			
38 x 181 x 445 mm	316,89	1	FF1E2001	

6700SM-4, 6700SM-5, 6700SM-5.5, 6700SM-6, 6700SM-7, 6700SM-8, 6700SM-9, 6700SM-10, 6700SM-11, 6700SM-12, 6700SM-13, 6700SM-14		
---	--	--

6700TORX-E4, 6700TORX-E5, 6700TORX-E6, 6700TORX-E7, 6700TORX-E8, 6700TORX-E10		
---	--	--

6709M-3, 6709M-4, 6709M-5, 6709M-6, 6709M-8		
---	--	--

6709TORX-T8, 6709TORX-T9, 6709TORX-T10, 6709TORX-T15, 6709TORX-T20, 6709TORX-T25, 6709TORX-T30, 6709TORX-T27, 6709TORX-T40		
--	--	--

6950SL	
--------	--

6954	
------	--

6956	
------	--

6960	
------	--

6966	
------	--

FF1E2002-45 peças



FF1E2002

	€		
38 x 181 x 445 mm	334,28	1	FF1E2002

6700SM-4, 6700SM-4.5, 6700SM-5, 6700SM-5.5, 6700SM-6, 6700SM-7, 6700SM-8, 6700SM-9, 6700SM-10, 6700SM-11, 6700SM-12, 6700SM-13, 6700SM-14		
6709PZ-1, 6709PZ-3, 6709PZ-2		
6709PH-1, 6709PH-2, 6709PH-3		
6709TORX-T10, 6709TORX-T15, 6709TORX-T20, 6709TORX-T25, 6709TORX-T30, 6709TORX-T40		
6709F-4.5, 6709F-5.5, 6709F-8		
6709M-3, 6709M-4, 6709M-5, 6709M-6, 6709M-8		
1998M-3, 1998M-2.5, 1998M-2, 1998M-1.5		
6950SL		
6962-W		
6966		
6956		
6960, 6961		
7765		
6954		

FF1E2003-27 peças



FF1E2003

	€		
38 x 181 x 445 mm	199,15	1	FF1E2003

6700SM-5, 6700SM-5.5, 6700SM-6, 6700SM-7, 6700SM-8, 6700SM-9, 6700SM-10, 6700SM-11, 6700SM-12, 6700SM-13, 6700SM-14		
BE-9778		
6950SL		
6956		
6962		

6966

7765

6954

1998M-12

FF1E2004-48 peças



FF1E2004

	€		
44 x 181 x 445 mm	210,24	1	FF1E2004

A6700DM-8, A6700DM-9, A6700DM-10, A6700DM-11, A6700DM-12, A6700DM-13, A6700DM-14, A6700DM-5, A6700DM-5.5, A6700DM-6, A6700DM-7		
808050S		
6950SL		
6966		
6972H		
6962		
7765		
59S/31-1		

FF1E2005-17 peças



FF1E2005

	€		
35 x 181 x 445 mm	177,41	1	FF1E2005

6700SM-5.5, 6700SM-6, 6700SM-7, 6700SM-8, 6700SM-9, 6700SM-10, 6700SM-11, 6700SM-12, 6700SM-13, 6700SM-14		
6950RN		
6962, 6960		
6966		
6954		
6956		
6972H		

FF1E2006-35 peças



FF1E2006

	€		
39 x 181 x 445 mm	323,54	1	FF1E2006

6700SZ-5/16, 6700SZ-5/32, 6700SZ-11/32, 6700SZ-7/16, 6700SZ-9/32, 6700SZ-3/16, 6700SZ-3/8, 6700SZ-7/32, 6700SZ-1/4, 6700SZ-1/2, 6700SZ-9/16		
6709PZ-1, 6709PZ-2, 6709PZ-3		
6709PH-1, 6709PH-2, 6709PH-3		
6709TORX-T8, 6709TORX-T10, 6709TORX-T15, 6709TORX-T20, 6709TORX-T25, 6709TORX-T30		
6709F-4.5, 6709F-6.5, 6709F-8		
6950RN		
6954		
6972H		
6960, 6962		
6963		
6966		
6956		
7765		

FF1E2007-24 peças



FF1E2007

	€		
35 x 181 x 445 mm	182,26	1	FF1E2007

6700SZ-9/32, 6700SZ-3/16, 6700SZ-3/8, 6700SZ-1/4, 6700SZ-7/16, 6700SZ-7/32, 6700SZ-1/2, 6700SZ-11/32		
1995Z-5/64, 1995Z-5/32, 1995Z-3/8, 1995Z-3/32, 1995Z-7/32, 1995Z-1/8, 1995Z-5/16, 1995Z-3/16, 1995Z-1/4		
6950RN		
6954		
6972H		
6960, 6962		
6956		
6966		



FF1E2008-26 peças



FF1E2008

	€		
35 x 181 x 445 mm	189,82	1	FF1E2008

6700SM-5.5, 6700SM-6, 6700SM-7, 6700SM-8, 6700SM-9, 6700SM-10, 6700SM-11, 6700SM-12, 6700SM-13, 6700SM-14		
1995M-2, 1995M-3, 1995M-4, 1995M-5, 1995M-6, 1995M-7, 1995M-8, 1995M-9, 1995M-10		
6950RN		
6960, 6962		
6966		
6954		
6956		
6972H		

FF1E2101-24 peças



FF1E2101

	€		
40 x 181 x 445 mm	276,19	1	FF1E2101

7400SM-6, 7400SM-7, 7400SM-8, 7400SM-9, 7400SM-10, 7400SM-11, 7400SM-12, 7400SM-13, 7400SM-14, 7400SM-15, 7400SM-16, 7400SM-17, 7400SM-18, 7400SM-19, 7400SM-20, 7400SM-22		
7750SL		
7760, 7761, 7762		
7764		
7766		
7754		
8164-1/2		

FF1E2102-25 peças



FF1E2102

	€		
38 x 181 x 445 mm	292,79	1	FF1E2102

7400SM-6, 7400SM-7, 7400SM-8, 7400SM-9, 7400SM-10, 7400SM-11, 7400SM-12, 7400SM-13, 7400SM-14, 7400SM-15, 7400SM-16, 7400SM-17, 7400SM-18, 7400SM-19		
7409M-4, 7409M-5, 7409M-6, 7409M-8, 7409M-10		
7750SL		
7760, 7762		
7754		
7768		
8164-1/2		

FF1E2103-28 peças



FF1E2103

	€		
38 x 181 x 445 mm	353,06	1	FF1E2103

7400SM-7, 7400SM-8, 7400SM-9, 7400SM-10, 7400SM-11, 7400SM-12, 7400SM-13, 7400SM-14, 7400SM-15, 7400SM-16, 7400SM-17, 7400SM-18, 7400SM-19, 7400SM-20, 7400SM-21, 7400SM-22		
7400TORX-E8, 7400TORX-E10, 7400TORX-E12, 7400TORX-E14, 7400TORX-E16, 7400TORX-E18		
7750SL		
7760, 7762		
7768		
7766		
SBS705		

FF1E2104-20 peças



FF1E2104

	€		
38 x 181 x 445 mm	255,04	1	FF1E2104

7400SM-6, 7400SM-8, 7400SM-9, 7400SM-10, 7400SM-11, 7400SM-12, 7400SM-13, 7400SM-14, 7400SM-15, 7400SM-16, 7400SM-17, 7400SM-18, 7400SM-19, 7400SM-20, 7400SM-22		
7750RN		
7761, 7762		
7766		
7768		

FF1E2105-28 peças



FF1E2105

	€		
35 x 181 x 445 mm	324,81	1	FF1E2105

7400TORX-E8, 7400TORX-E10, 7400TORX-E11, 7400TORX-E12, 7400TORX-E14, 7400TORX-E16, 7400TORX-E18		
7409TORX-T25, 7409TORX-T30, 7409TORX-T40, 7409TORX-T45, 7409TORX-T50		
7409TORX-T25-L, 7409TORX-T30-L, 7409TORX-T40-L, 7409TORX-T45-L, 7409TORX-T50-L		
7409M-4, 7409M-5, 7409M-6, 7409M-8, 7409M-10		
7409F-6.5, 7409F-8, 7409F-10		
7409PH-1, 7409PH-2, 7409PH-3		

FF1E2201-21 peças

**FF1E2201**

€ 44 x 181 x 445 mm 264,07 1 FF1E2201

7800SM-10, 7800SM-11, 7800SM-12, 7800SM-13, 7800SM-14, 7800SM-15, 7800SM-17, 7800SM-18, 7800SM-19, 7800SM-20, 7800SM-21, 7800SM-22, 7800SM-24, 7800SM-27

7805SM-16, 7805SM-21

8150SL

8160-5, 8160-10

8166

8171

FF1E2203-22 peças

**FF1E2203**

€ 50 x 181 x 445 mm 245,50 1 FF1E2203

7800SM-8, 7800SM-9, 7800SM-10, 7800SM-11, 7800SM-12, 7800SM-13, 7800SM-14, 7800SM-15, 7800SM-16, 7800SM-17, 7800SM-18, 7800SM-19, 7800SM-22, 7800SM-21, 7800SM-24, 7800SM-27, 7800SM-30, 7800SM-32

8150RN-1/2

8160-5, 8160-10

8166

FF1E2205-28 peças

**FF1E2205**

€ 50 x 181 x 445 mm 272,64 1 FF1E2205

7800DM-10, 7800DM-11, 7800DM-12, 7800DM-13, 7800DM-14, 7800DM-15, 7800DM-16, 7800DM-17, 7800DM-18, 7800DM-19, 7800DM-20, 7800DM-21, 7800DM-22, 7800DM-23, 7800DM-24, 7800DM-25, 7800DM-26, 7800DM-27, 7800DM-28, 7800DM-30, 7800DM-32

7809M-6, 7809M-7, 7809M-8, 7809M-9, 7809M-10, 7809M-12, 7809M-14

FF1E2202-21 peças

**FF1E2202**

€ 45 x 181 x 445 mm 233,29 1 FF1E2202

7800SM-8, 7800SM-9, 7800SM-10, 7800SM-11, 7800SM-12, 7800SM-13, 7800SM-14, 7800SM-15, 7800SM-16, 7800SM-17, 7800SM-18, 7800SM-19, 7800SM-20, 7800SM-21, 7800SM-23, 7800SM-24, 7800SM-27

8150-1/2

8160-5, 8160-10

8166

FF1E2204-15 peças

**FF1E2204**

€ 45 x 181 x 445 mm 193,32 1 FF1E2204

7800DZ-1/2, 7800DZ-3/4, 7800DZ-19/32, 7800DZ-7/8, 7800DZ-7/16, 7800DZ-11/16, 7800DZ-9/16, 7800DZ-13/16, 7800DZ-3/8, 7800DZ-5/8, 7800DZ-15/16

8150RN-1/2

8160-5, 8160-10

8166

FF1E2206-27 peças

**FF1E2206**

€ 50 x 181 x 445 mm 267,90 1 FF1E2206

7800SM-10, 7800SM-11, 7800SM-12, 7800SM-13, 7800SM-14, 7800SM-15, 7800SM-16, 7800SM-17, 7800SM-18, 7800SM-19, 7800SM-20, 7800SM-21, 7800SM-22, 7800SM-23, 7800SM-24, 7800SM-25, 7800SM-26, 7800SM-27, 7800SM-28, 7800SM-30, 7800SM-32

7809XZN-8, 7809XZN-10

7809PZ-2, 7809PZ-3

7809F-8, 7809F-10



FF1E2207-25 peças



FF1E2207



	€		
40 x 181 x 445 mm	282,14	1	FF1E2207

7809TORX-T20, 7809TORX-T25,
7809TORX-T27, 7809TORX-T30,
7809TORX-T40, 7809TORX-T55,
7809TORX-T45, 7809TORX-T50,
7809TORX-T60



7800TORX-E8, 7800TORX-E10,
7800TORX-E12, 7800TORX-E14,
7800TORX-E16, 7800TORX-E18,
7800TORX-E20, 7800TORX-E24



BE-9675



FF1E2208-12 peças



FF1E2208



	€		
35 x 181 x 445 mm	163,85	1	FF1E2208

7809M-6, 7809M-7, 7809M-8, 7809M-9,
7809M-10, 7809M-12, 7809M-14,
7809M-17



7809M-5-180, 7809M-6-140, 7809M-8-120,
7809M-10-140



FF1E2209-20 peças



FF1E2209



	€		
35 x 181 x 445 mm	286,87	1	FF1E2209

7809M-5, 7809M-6, 7809M-7, 7809M-8,
7809M-10, 7809M-12, 7809M-14,
7809M-17



7809TORX-T25, 7809TORX-T27,
7809TORX-T30, 7809TORX-T40,
7809TORX-T45, 7809TORX-T50,
7809TORX-T55, 7809TORX-T60



7809XZN-6, 7809XZN-8, 7809XZN-10,
7809XZN-12



FF1E2210-14 peças



FF1E2210



	€		
38 x 181 x 445 mm	225,23	1	FF1E2210

7809M-5, 7809M-6, 7809M-7, 7809M-8,
7809M-10, 7809M-12, 7809M-14,
7809M-17, 7809M-19



BE-7606, BE-7607



BWSS12P317, BWSS12P319,
BWSS12P321



FF1E2211-21 peças



FF1E2211



	€		
50 x 181 x 445 mm	314,13	1	FF1E2211

7993S0050, 7993S0060, 7993S0080,
7993S0100, 7993S0120, 7993S0140,
7993S0170, 7993S0190



7994S0300, 7994S0400, 7994S0450,
7994S0500, 7994S0550, 7994S0600



K7801TORX-E10, K7801TORX-E12,
K7801TORX-E14, K7801TORX-E16,
K7801TORX-E18, K7801TORX-E20,
K7801TORX-E24



FF1E2212-12 peças



FF1E2212



	€		
40 x 181 x 445 mm	124,48	1	FF1E2212

K7801M-10, K7801M-12, K7801M-13,
K7801M-14, K7801M-15, K7801M-16,
K7801M-17, K7801M-18, K7801M-19,
K7801M-21, K7801M-22, K7801M-24



FF1E2213-15 peças

**FF1E2213**

45 x 181 x 445 mm 248,94 1 FF1E2213

K7806M-10, K7806M-12, K7806M-13,
K7806M-14, K7806M-15, K7806M-16,
K7806M-17, K7806M-18, K7806M-19,
K7806M-21, K7806M-22, K7806M-24,
K7806M-27, K7806M-30, K7806M-32

FF1E2501-13 peças

**FF1E2501**

35 x 181 x 445 mm 220,29 1 FF1E2501

A7402DM-10, A7402DM-11,
A7402DM-12, A7402DM-13,
A7402DM-14

7805SM-12, 7805SM-13, 7805SM-14,
7805SM-15, 7805SM-16, 7805SM-17,
7805SM-18, 7805SM-19

FF1E2502-7 peças

**FF1E2502**

45 x 181 x 445 mm 94,83 1 FF1E2502

K560F-4, K560F-5

K8167S

K8160D-1, K8160D-2

K7764D

K8964D

FF1E5005-35 peças

**FF1E5005**

36 x 181 x 445 mm 160,04 1 FF1E5005

BWTSP16

1418S

FF1E5006-6 peças

**FF1E5006**

42 x 181 x 445 mm 118,54 1 FF1E5006

D/S14

BWSS12P3

BWTB12P120, BWTB12P110

FF1E5009-17 peças

**FF1E5009**

36 x 181 x 445 mm 82,98 1 FF1E5009

BE6217

FF1E3001-9 peças

**FF1E3001**

47 x 181 x 445 mm 111,86 1 FF1E3001

6M-6-7, 6M-8-9, 6M-10-11, 6M-12-13, 6M-14-15,
6M-16-17, 6M-18-19, 6M-21-23, 6M-22-24

FF1E3002-3 peças

**FF1E3002**

35 x 181 x 445 mm 87,27 1 FF1E3002

6M-25-28, 6M-27-29, 6M-30-32



FF1E3003-9 peças



FF1E3003

	€		
41 x 181 x 445 mm	119,06	1	FF1E3003

- 6Z-1/2-9/16, 6Z-15/16-1, 6Z-5/16-11/32, 6Z-5/8-3/4, 6Z-3/8-7/16, 6Z-25/32-13/16, 6Z-19/32-11/16, 6Z-1/4-5/16, 6Z-3/4-7/8

FF1E3004-10 peças



FF1E3004

	€		
39 x 181 x 445 mm	277,38	1	FF1E3004

- 1RM-10, 1RM-9, 1RM-8, 1RM-14, 1RM-13, 1RM-12, 1RM-11, 1RM-17, 1RM-16, 1RM-15

FF1E3005-40 peças



FF1E3005

	€		
42 x 181 x 445 mm	245,38	1	FF1E3005

- 59S/31-1
- 6966
- 41RM-8, 41RM-10, 41RM-12, 41RM-13, 41RM-14, 41RM-17, 41RM-19
- 8166

FF1E3006-8 peças



FF1E3006

	€		
35 x 181 x 445 mm	296,35	1	FF1E3006

- 1320RM-6-7, 1320RM-8-9, 1320RM-10-11, 1320RM-12-13, 1320RM-14-15, 1320RM-16-17, 1320RM-18-19, 1320RM-22-24

FF1E3007-7 peças



FF1E3007

	€		
35 x 181 x 445 mm	92,46	1	FF1E3007

- 2M-6-7, 2M-8-9, 2M-10-11, 2M-12-13, 2M-14-15, 2M-16-17, 2M-18-19

FF1E3008-9 peças



FF1E3008

	€		
50 x 181 x 445 mm	194,41	1	FF1E3008

- 27M-8-9, 27M-10-11, 27M-12-13, 27M-14-15, 27M-16-17, 27M-18-19, 27M-20-22, 27M-21-23, 27M-24-27

FF1E4001-4 peças



ergo



FF1E4001

	€		
35 x 181 x 445 mm	142,00	1	FF1E4001

- 2628 G-180IP
- 8231 IP
- 2430 G-200 IP
- 2101G-160IP

FF1E4002-4 peças



FF1E4002

	€		
35 x 181 x 445 mm	101,71	1	FF1E4002

- 2900-180
- 2890-180
- 2990-180
- 2800-180

FF1E5007-3 peças



ergo



FF1E5007

	€		
38 x 181 x 445 mm	171,89	1	FF1E5007

- 1410
- 9033
- 8225

FF1E5001-7 peças



FF1E5001

45 x 181 x 445 mm € 201,34 1 FF1E5001

- MTB-5-25
- 8045LVDE
- WR2-MM
- 1544
- 1178-SCRIBE
- 5515T
- 1150D

FF1E5004-35 peças



FF1E5004

36 x 181 x 445 mm € 100,75 1 FF1E5004

- 481-400
- 3734S/6
- 7865

FF1E5002-11 peças



FF1E5002

35 x 181 x 445 mm € 112,60 1 FF1E5002

- 3740-150, 3740-175, 3740-200
- 3734-2, 3734-3, 3734-4, 3734-5, 3734-6, 3734-8
- 481-100
- 1157

FF1E5003-11 peças



FF1E5003

35 x 181 x 445 mm € 106,68 1 FF1E5003

- 481-300
- 3735-5-120
- 3739-300
- 3740-100, 3740-125, 3740-150, 3740-200
- 3733-2, 3733-3, 3733-4, 3733-5

FF1E5008-4 peças



FF1E5008

37 x 181 x 445 mm € 112,60 1 FF1E5008

- 7805ZZ-16, 7805ZZ-21
- BE1P
- BE61110

Conjunto de chaves de parafusos e chaves de fendas ERGO™ em inserção de espuma 1/3 Fit&Go - 6 peças por embalagem



ergo™



FF1E1012EH

55 x 185 x 480 mm € 51,56 1 FF1E1012EH

- BE-8030
- BE-8150
- BE-8621, BE-8611
- BE-8811, BE-8821

Conjunto de chaves de parafusos TORX® T8-T30 em inserção de espuma 1/3 Fit&Go - 6 peças por embalagem



ergo™



FF1E1009EH

55 x 185 x 480 mm € 51,56 1 FF1E1009EH

- BE-8908, BE-8910, BE-8915, BE-8920, BE-8925, BE-8930

Conjunto de chaves de parafusos e chaves de fendas ERGO™ em inserção de espuma 1/3 Fit&Go - 6 peças por embalagem



ergo™



FF1E1013EH

55 x 185 x 480 mm € 91,66 1 FF1E1013EH

- BE-8135TB, BE-8145TB, BE-8150TB, BE-8155TB
- BE-8810TB, BE-8820TB



Conjunto de chaves de caixa 1/4" e pontas em inserção de espuma 1/3 Fit&Go - 46 peças por embalagem



FF1E2009EH

	€		
55 x 185 x 480 mm	108,85	1	FF1E2009EH

59/S31B-IP

6700SM-4, 6700SM-4.5, 6700SM-5, 6700SM-5.5, 6700SM-6, 6700SM-7, 6700SM-8, 6700SM-9, 6700SM-10, 6700SM-11, 6700SM-12, 6700SM-13		
--	--	--

6962-W

6972H

6950SL

Conjunto de chaves de caixa longas 1/4" em inserção de espuma 1/3 Fit&Go - 11 peças por embalagem



FF1E2010EH

	€		
55 x 185 x 480 mm	57,29	1	FF1E2010EH

S0810L

1419-MD

Conjunto de chaves de caixa 3/8" em inserção de espuma 1/3 Fit&Go - 18 peças por embalagem



FF1E2106EH

	€		
55 x 185 x 480 mm	103,12	1	FF1E2106EH

7400SM-10, 7400SM-11, 7400SM-12, 7400SM-13, 7400SM-14, 7400SM-15, 7400SM-16, 7400SM-17, 7400SM-18, 7400SM-19, 7400SM-20, 7400SM-22

7760, 7761

7766

SBS750

7402GPR-16, 7402GPR-21

Conjunto de chaves de caixa 1/2" em inserção de espuma 1/3 Fit&Go - 21 peças por embalagem



FF1E2214EH

	€		
55 x 185 x 480 mm	229,15	1	FF1E2214EH

7800SM-10, 7800SM-11, 7800SM-12, 7800SM-13, 7800SM-14, 7800SM-15, 7800SM-16, 7800SM-17, 7800SM-18, 7800SM-19, 7800SM-20, 7800SM-21, 7800SM-22, 7800SM-23, 7800SM-24, 7800SM-27, 7800SM-30, 7800SM-32

8150SL

8174A

8166

Conjunto de chaves de caixa longas 3/8" em inserção de espuma 1/3 Fit&Go - 14 peças por embalagem



FF1E2107EH

	€		
55 x 185 x 480 mm	74,48	1	FF1E2107EH

S1214L

Conjunto de chaves de caixa longas 1/2" em inserção de espuma 1/3 Fit&Go - 12 peças por embalagem



FF1E2215EH

	€		
55 x 185 x 480 mm	91,66	1	FF1E2215EH

S1612L

Conjunto de pontas em inserção de espuma 1/3 Fit&Go - 49 peças por embalagem



FF1E2503EH

	€		
55 x 185 x 480 mm	143,22	1	FF1E2503EH

BE5049

Conjunto de chaves combinadas em inserção de espuma 1/3 Fit&Go - 11 peças por embalagem



FF1E3009EH

	€		
55 x 185 x 480 mm	85,93	1	FF1E3009EH

111M-8, 111M-10, 111M-11, 111M-12, 111M-13, 111M-14, 111M-15, 111M-16, 111M-17, 111M-18, 111M-19

Conjunto de chaves de roquete 1RM em inserção de espuma 1/3 Fit&Go - 5 peças por embalagem



FF1E3010EH

	€		
55 x 185 x 480 mm	91,66	1	FF1E3010EH

1RM-8, 1RM-10, 1RM-13, 1RM-17, 1RM-19



Conjunto de chaves ajustáveis e prato magnético em inserção de espuma 1/3 Fit&Go - 4 peças por embalagem



FF1E3011EH

	€		
55 x 185 x 480 mm	108,85	1	FF1E3011EH

8070 IP, 8071 IP, 8072 IP

1419-MD



Conjunto de alicates em inserção de espuma 1/3 Fit&Go - 3 peças por embalagem



FF1E4003EH

	€		
55 x 185 x 480 mm	97,39	1	FF1E4003EH

8224 IP

2101G-160IP

2430 G-160 IP



Conjunto de tesouras para metal e alicate de rebitar em inserção de espuma 1/3 Fit&Go - 4 peças por embalagem



FF1E4004EH

	€		
55 x 185 x 480 mm	108,85	1	FF1E4004EH

2681

MA401

MA411

1178-SCRIBE



Conjunto de chaves de impacto, punções e martelo em inserção de espuma 1/3 Fit&Go - 23 peças por embalagem



FF1E5010EH

	€		
55 x 185 x 480 mm	103,12	1	FF1E5010EH

481-400

3734-2, 3734-3, 3734-4, 3734-5, 3734-6, 3734-8

3735-5-120

7865



Conjunto de alicates para anéis de retenção em inserção de espuma 1/3 Fit&Go - 4 peças por embalagem



FF1E4005EH

	€		
55 x 185 x 480 mm	120,31	1	FF1E4005EH

2800-150, 2800-180

2900-150, 2900-180



Conjunto de sovelas, ganchos e lâminas em inserção de espuma 1/3 Fit&Go - 11 peças por embalagem



FF1E5011EH

	€		
55 x 185 x 480 mm	97,39	1	FF1E5011EH

2633/S4, 2633L/S4

2489

2485

KE18-01



Conjunto de pontas, chaves em L e prato magnético em inserção de espuma 1/3 Fit&Go - 36 peças por embalagem



FF1E5013EH

	€		
55 x 185 x 480 mm	91,66	1	FF1E5013EH

BE-9770

2058/S26

1419-MD



Conjunto de chaves de caixa 1/4" em inserção de espuma 1/3 Fit&Go - 25 peças por embalagem



FF1E2011EH

	€		
55 x 185 x 480 mm	68,75	1	FF1E2011EH

SL25



Conjunto de chaves de roquete e acessórios 1/2" em inserção de espuma 1/3 Fit&Go - 24 peças por embalagem



FF1E2216EH

	€		
55 x 185 x 480 mm	143,22	1	FF1E2216EH

SBS81	
S240NB-NR	

Conjunto de chaves de caixa 1/4" e 3/8" em inserção de espuma 1/3 Fit&Go - 33 peças por embalagem



FF1E2504EH

	€		
55 x 185 x 480 mm	91,66	1	FF1E2504EH

S330	
------	--

Conjunto de chaves de caixa 1/4" e 3/8" em inserção de espuma 1/3 Fit&Go - 34 peças por embalagem



FF1E2505EH

	€		
55 x 185 x 480 mm	91,66	1	FF1E2505EH

S330AF	
--------	--

Conjunto de chaves ajustáveis, alicates articulados e ferramentas para corte de metais em inserção de espuma 1/3 Fit&Go - 8 peças por embalagem



FF1E5014EH

	€		
55 x 185 x 480 mm	103,12	1	FF1E5014EH

9031P	
8224	
208	
3906-300-24-5P	

Espuma vazia com cavidades e suporte para pendurar 1/3



FF1E5016EH

	€		
35 x 181 x 445 mm	28,64	1	FF1E5016EH

Conjunto de limas ERGO™ em inserção de espuma 1/3 Fit&Go - 4 peças por embalagem



FF1E5015EH

	€		
55 x 185 x 480 mm	57,29	1	FF1E5015EH

1-100-08-2-2	
1-210-08-2-2	
4-138-08-1-2	
4-272-05-3-2	

ESTOJOS RÍGIDOS

Mala 4750RCWD4 com 162 ferramentas



4750RCWD4FF1

	€		
453 x 340 x 575 mm	2.183,69	1	4750RCWD4FF1

4750RCWD4	
6700SM-10, 6700SM-9, 6700SM-12, 6700SM-11, 6700SM-6, 6700SM-8, 6700SM-7, 6700SM-13	
A6800DM-13, A6800DM-12, A6800DM-9, A6800DM-8, A6800DM-11, A6800DM-10, A6800DM-5.5, A6800DM-7, A6800DM-6	
6709M-3, 6709M-8, 6709M-6, 6709M-5, 6709M-4	
6709PH-1, 6709PH-3, 6709PH-2	
6709TORX-T30, 6709TORX-T27, 6709TORX-T40, 6709TORX-T15, 6709TORX-T10, 6709TORX-T25, 6709TORX-T20, 6709TORX-T9, 6709TORX-T8	
6950SL	
6954	
6956	
6958	
6960, 6962, 6962L	
6966	
6972H	
7764	
7800SM-25, 7800SM-24, 7800SM-27, 7800SM-26, 7800SM-21, 7800SM-23, 7800SM-22, 7800SM-17, 7800SM-16, 7800SM-19, 7800SM-18, 7800SM-13, 7800SM-12, 7800SM-15, 7800SM-14, 7800SM-9, 7800SM-8, 7800SM-11, 7800SM-10, 7800SM-28, 7800SM-32, 7800SM-30	
7809TORX-T45, 7809TORX-T25, 7809TORX-T50, 7809TORX-T30, 7809TORX-T27, 7809TORX-T40	
8150RN-1/2	
111M-30, 111M-32, 111M-27, 111M-29, 111M-24, 111M-19, 111M-18, 111M-21, 111M-15, 111M-14, 111M-17, 111M-16, 111M-11, 111M-10, 111M-13, 111M-12, 111M-7, 111M-6, 111M-9, 111M-8	
9070C	
BE-9770	

2058-BR	
1544	
MTB-3-16	
2101G-160IP	
2427 G-200 IP	
2430 G-200 IP	
2628 G-160IP	
8224 IP	
1150-1/2H/P	
5515T-52	
2820EF2	
481-300	
3625W-35	
3734-3, 3734-5, 3734-8	
3735-4-120	
1177-SCRIBE	
BFLA01	
8160-3, 8160-5, 8160-10	
8166	
8157-15	
8154-11	

Caixa de ferramentas rígida com isolamento para trabalhos pesados - 79 peças



4750RCHDW02RF1V

€ 290 x 480 x 630 mm 3.036,30 1 4750RCHDW02RF1V

4750RCHDW02RED	
8150-1/2V	
BMMTRMS1	
28MV-10, 28MV-15, 28MV-16, 28MV-21, 28MV-22, 28MV-12, 28MV-13	
2101S-160, 2101S-180	
2101S-200	
2223 S-150	
2820VDE	
BE-8040S, BE-8050S, BE-8010S, BE-8065S	
BE-8703S, BE-8704S, BE-8725S, BE-8705S, BE-8706S, BE-8708S	

BE-8910S, BE-8915S, BE-8920S, BE-8925S, BE-8930S	
SC127V	
1999MV-5, 1999MV-6, 1999MV-7, 1999MV-8, 1999MV-9, 1999MV-10, 1999MV-12	
2430V-160, 2430V-200	
2678V-180, 2678V-160, 2678V-200	
3416 A	
806-1-1	
BE-8600S, BE-8610S, BE-8620S, BE-8630S, BE-8640S	
527V-160	
2427V-200	
2MV-10, 2MV-11, 2MV-12, 2MV-13, 2MV-14, 2MV-15, 2MV-16, 2MV-17, 2MV-18, 2MV-19	
WR1-MM	
7800DMV-8, 7800DMV-10, 7800DMV-11, 7800DMV-12, 7800DMV-13, 7800DMV-14, 7800DMV-15, 7800DMV-16, 7800DMV-17, 7800DMV-18, 7800DMV-19, 7800DMV-20, 7800DMV-21, 7800DMV-22	
2820VPC	
8162-1/2V	
7224S	

Composição MRO mala rígida c/rodas 4750RCHDW02 HD



4750RCHDW02FF1

€ 275 x 460 x 600 mm 2.492,05 1 4750RCHDW02FF1

4750RCHDW02	
6700SM-12, 6700SM-13, 6700SM-10, 6700SM-11, 6700SM-8, 6700SM-9, 6700SM-6, 6700SM-7, 6700SM-5.5	
A6800DM-13, A6800DM-11, A6800DM-12, A6800DM-9, A6800DM-10, A6800DM-7, A6800DM-8, A6800DM-5.5, A6800DM-6	
6709M-3, 6709M-4, 6709M-8, 6709M-5, 6709M-6	
6709PH-1, 6709PH-2, 6709PH-3	
6709TORX-T8, 6709TORX-T30, 6709TORX-T40, 6709TORX-T25, 6709TORX-T27, 6709TORX-T15, 6709TORX-T20, 6709TORX-T9, 6709TORX-T10	

6950SL	
6954	
6956	
6958	
6960, 6962, 6962L	
6966	
6972H	
7764	
7800SM-13, 7800SM-14, 7800SM-11, 7800SM-12, 7800SM-9, 7800SM-10, 7800SM-8, 7800SM-32, 7800SM-30, 7800SM-27, 7800SM-28, 7800SM-25, 7800SM-26, 7800SM-23, 7800SM-24, 7800SM-21, 7800SM-22, 7800SM-19, 7800SM-17, 7800SM-18, 7800SM-15, 7800SM-16	
7805SM-22, 7805SM-23, 7805SM-21, 7805SM-18, 7805SM-19, 7805SM-16, 7805SM-17, 7805SM-14, 7805SM-15, 7805SM-12, 7805SM-13, 7805SM-10, 7805SM-32, 7805SM-30, 7805SM-26, 7805SM-24, 7805SM-29, 7805SM-28, 7805SM-25, 7805SM-20	
7809TORX-T30, 7809TORX-T40, 7809TORX-T25, 7809TORX-T27, 7809TORX-T50, 7809TORX-T45	
8150RN-1/2	
111M-23, 111M-24, 111M-21, 111M-22, 111M-19, 111M-17, 111M-18, 111M-15, 111M-16, 111M-13, 111M-14, 111M-11, 111M-12, 111M-9, 111M-10, 111M-7, 111M-8, 111M-6, 111M-32, 111M-29, 111M-30, 111M-27, 111M-28, 111M-26, 111M-25	
1RM-18, 1RM-19, 1RM-16, 1RM-17, 1RM-14, 1RM-15, 1RM-12, 1RM-13, 1RM-10, 1RM-11, 1RM-8, 1RM-9, 1RM-6, 1RM-7	
9070C	
BE-9770	
BE-8571	
2058-BR	
2509	
1544	
2101G-160IP	
2427 G-200 IP	
2430 G-200 IP	
2628 G-160IP	
8224 IP	
1150-1/2H/P	
5515T-52	
2820EF2	
481-300	
3625W-35	
3734-3, 3734-5, 3734-8	
3735-4-120	
1177-SCRIBE	
2535F1	
BFLA01	
MTB-3-16	
8160-3, 8160-5, 8160-10	
8166	
8154-11	
8157-15	



Mala 4750RCHDW02 c/167 ferramentas gerais p/eólicas



4750RCHDW02FF2

	€	
480 x 290 x 630 mm	2.807,14	1 4750RCHDW02FF2

4750RCHDW02	
6700SM-12, 6700SM-13, 6700SM-10, 6700SM-11, 6700SM-8, 6700SM-9, 6700SM-6, 6700SM-7, 6700SM-5.5	
6954	
6956	
6958	
6960, 6961, 6962, 6962L	
6966	
6972H	
6950SL	
7800SM-13, 7800SM-14, 7800SM-11, 7800SM-12, 7800SM-10, 7800SM-32, 7800SM-30, 7800SM-27, 7800SM-24, 7800SM-21, 7800SM-19, 7800SM-17, 7800SM-18, 7800SM-15, 7800SM-16, 7800SM-22	
7809M-7, 7809M-6, 7809M-17, 7809M-19, 7809M-5, 7809M-14, 7809M-12, 7809M-10, 7809M-8	
7809TORX-T60, 7809TORX-T40, 7809TORX-T55, 7809TORX-T50, 7809TORX-T45	
59S/31-1	
8150SL	
111M-24, 111M-21, 111M-19, 111M-17, 111M-18, 111M-15, 111M-16, 111M-13, 111M-14, 111M-11, 111M-12, 111M-9, 111M-10, 111M-7, 111M-8, 111M-6, 111M-32, 111M-29, 111M-30, 111M-27	
BE-9770	
1177-SCRIBE	

6M-6-7, 6M-8-9, 6M-10-11, 6M-12-13, 6M-14-15, 6M-16-17, 6M-18-19, 6M-20-22, 6M-24-27, 6M-30-32	
MTB-3-16-E	
9070, 9072	
2535L	
BE-8020L, BE-8030	
BE-8155	
BE-8260	
BE-8610, BE-8620	
BE-8630	
BE-8810, BE-8820	
BE-8830	
1544	
2047-0.8-4	
TAH2047PR-1-2	
2058-BR	
2509	
808050P	
808050S	
BE-8220S, BE-8040S, BE-8050S	
BE-8610S, BE-8620S	
2535F2	
1150-1/2H/P	
2101G-160IP	
2427 G-200 IP	
2430 G-200 IP	
2628 G-160IP	
2820EF2	
5515T-52	
8224 IP	
BFLA01	
3625W-35	
3734-3, 3734-5, 3734-8	
3735-4-120	
481-300	
3680	
3875-RL1	
3875-WL1	
4750-3PB-2	
3750	
8157-15	
8154-11	
8160-5, 8160-10	
8171	
8166	

Kit aplicação para ferramentas standard em turbinas eólicas. Adequado para trabalhos em altura



4750RCHDW02FF4

	€	
480 x 290 x 630 mm	3.959,33	1 4750RCHDW02FF4

TAH9070, TAH9072	
TAH3625W-35	
TAH481-300	
TAHBE-9777B	
TAH2820EF2	
TAH1150-1/2H/P	
TAH1177-SCRIBE	
TAH1544	
TAH2509	
TAH2535F2	
MTS-5-25	
TAHPINRELEASER	
TAH2427G-200	
TAH2430G-200	
TAH2628G-160	
TAH8224	
TAH2484-30	
TAH3734BM-3, TAH3734BM-8, TAH3734BM-5	
TAH3755BM-4	
TAHSCB140G	
TAHBE-8030, TAHBE-8020L	
TAHBE-8040S, TAHBE-8050S, TAHBE-8220S	
TAHBE-8155	
TAHBE-8260	
TAHBE-8620S, TAHBE-8610S	
TAHBE-8620, TAHBE-8610	
TAHBE-8630	
TAHBE-8810, TAHBE-8820	
TAHBE-8830	

TAH08-5.5, TAH08-9, TAH08-7, TAH08-8, TAH08-13, TAH08-6, TAH08-11, TAH08-10, TAH08-12		
TAH6961, TAH6962, TAH6960, TAH6962L		
TAH6956-1		
TAH6950		
TAH6966		
TAH6958B-1		
TAH16B-27, TAH16B-30, TAH16B-24, TAH16B-22, TAH16B-32, TAH16B-19, TAH16B-21, TAH16B-17, TAH16B-18, TAH16B-11, TAH16B-15, TAH16B-16, TAH16B-13, TAH16B-10, TAH16B-14, TAH16B-12		
TAH16-H8, TAH16-H6, TAH16-H7, TAH16-H5, TAH16-H17, TAH16-H19, TAH16-H12, TAH16-H14, TAH16-H10		
TAH16-T40, TAH16-T45, TAH16-T50, TAH16-T55, TAH16-T60		
TAH8166		
TAH8150-1/2		
TAH8160, TAH8162		
TAH8158B-1		
TAH111M-32, TAH111M-27, TAH111M-24, TAH111M-21, TAH111M-22, TAH111M-19, TAH111M-9, TAH111M-7, TAH111M-8, TAH111M-18, TAH111M-6, TAH111M-16, TAH111M-17, TAH111M-14, TAH111M-15, TAH111M-12, TAH111M-13, TAH111M-10, TAH111M-11, TAH111M-30		
TAH2101G-160		
TAH2047PR-1-2		
TAH2047-0.8-4		
4750RCHDW02		

Kit para ferramentas de trabalho pesado em turbinas eólicas. Adequado para trabalhos em altura



4750RCHDW02FF15

€
480 x 290 x 630 mm 3.661,68 1 4750RCHDW02FF15

TAH1-100-06-2-4		
TAH1-210-06-2-2		
TAH1-230-06-2-2		

TAH3625PU-50		
TAH489-1100		
TAHBE64520		
TAHPINRELEASER		
TAHSCB140G		
TAH24B-50, TAH24B-46, TAH24B-41, TAH24B-38, TAH24B-36, TAH24B-32, TAH24B-30, TAH24B-27		
TAH8950N/A		
TAH8961		
TAH8953		
TAH7452-2		
TAH7435-100		
TAH111M-50, TAH111M-46, TAH111M-41, TAH111M-36, TAH111M-34		
TAH7444SG-M-46, TAH7444SG-M-41, TAH7444SG-M-36, TAH7444SG-M-55, TAH7444SG-M-50		
4750RCHDW02		
TAH73R-300		

Mala rígida 4750RCHDW01 com 240 ferramentas



4750RCHDW01FF1

€
250 x 345 x 545 mm 4.150,39 1 4750RCHDW01FF1

4750RCHDW01		
FF2B01		
FF2B02		
FF2B03		
FF2B04		
FF2B05		
FF2B06		

Mala rígida 4750RCHDW01 com 159 ferramentas



4750RCHDW01FF2

€
250 x 345 x 545 mm 2.999,37 1 4750RCHDW01FF2

4750RCHDW01		
FF2B07		
FF2B08		
FF2B09		
FF2B10		
FF2B11		

Mala rígida 4750RCHDW01 com 194 ferramentas



4750RCHDW01FF3

€
250 x 345 x 545 mm 2.671,03 1 4750RCHDW01FF3

4750RCHDW01		
FF2B12		
FF2B13		
FF2B14		
FF2B15		
FF2B16		



Kit para manutenção de guias de petróleo e gás offshore. Adequado para trabalhos em altura



4750RCHDW01FF4



€



1 4750RCHDW01FF4

250 x 345 x 545 mm

1.876,90

TAH8075	
TAH479-32	
TAHBE-9777B	
TAHBE-9787	
TAH2820EF2	
TAHBFRL11	
TAH466-250	
TAHPINRELEASER	
TAH380-10	
TAH2101G-160	
TAH2628G-180	
TAH2855	
TAH8224	
TAHSCB140G	
TAHBE-8258	
TAHBE-8241, TAHBE-8252	
TAHBE-8620L, TAHBE-8620	
4750RCHDW01	
4750-HDLB-TAH	
3875-LY9	
3875-LY5	
3875-RL2	
3875-MHP4	
3875-MHP6	
3875-HB60	
3875-LY60	
3875-LY70	

Kit de aplicação para formação em petróleo e gás offshore. Adequado para trabalhos em altura



4750RCHDW01FF9



€



1 4750RCHDW01FF9

250 x 345 x 545 mm

2.834,84

TAH8073	
TAH84-PODGER	
TAH3640-250-C	
TAH1-143-12-1-2	
TAH479-32	
TAH325	
TAHBE-9777B	
TAH2820EF2	
TAHBFRL11	
TAHPINRELEASER	
TAH380-14	
TAH2101G-140	
TAH2628G-180	
TAH2855	
TAH2958-250	
TAH2484-30	
TAH3734BM-8	
TAHSCB140G	
TAHBE-8257	
TAHBE-8602	
TAH16B-19	
TAH16B-11/16	
TAH16-H8	
TAH8150-1/2	
TAH8158B-1	
TAH1949M-14-17	
4750RCHDW01	
4750-HDLB-TAH	
3875-LY9	
3875-LY5	
3875-RL2	
3875-MHP4	
3875-MHP6	
3875-HB60	
3875-LY60	
3875-LY70	
MTS-5-25	

4750-MTHO-TAH	
3875-HB60	
TAH2487	
TAH466-250	
3875-LY60	
3875-LY70	
TAH73R-300	

Mala 4750RCHD01 + FF2A07 + FF2A08 + FF2A09 + FF2A10



4750RCHD01FF1



€



1 4750RCHD01FF1

215 x 410 x 475 mm

2.749,85

4750RCHD01	
FF2A07	
FF2A08	
FF2A10	
FF2A09	

Mala Alumínio, 145 peças



4750ALC01FF1



€



1 4750ALC01FF1

160 x 320 x 450 mm

808,55

111M-14, 111M-15, 111M-16, 111M-17, 111M-18, 111M-19, 111M-8, 111M-9, 111M-10, 111M-11, 111M-12, 111M-13	
--	--

BE-9678	
8072 C IP	
224 D	
2171G-160	
2339-220IP	
2678 G-180	
2470 G-160	
SCB140	
B191.030.075, B191.040.125	
B190.055.125, B190.065.150	
B192.001.100, B192.002.125	
806-1-1	
482F-30	
MTB-5-25	
208	
KB18-01	
808050TS	
59S/0.6-4.5-3P, 59S/1.0-5.5-3P, 59S/1.2-6.5-3P	
59S/PH1-3P, 59S/PH2-3P, 59S/PH3-3P, 59S/PH0-3P	
59S/PH2G-3P	
59S/PZ2-3P, 59S/PZ3-3P, 59S/PZ0-3P, 59S/PZ1-3P	
66IM/T20C-2P, 66IM/T15C-2P, 66IM/T10C-2P, 66IM/T40C-2P, 66IM/T30C-2P, 66IM/T27C-2P, 66IM/T25C-2P	
59S/H1.5-3P, 59S/H3-3P, 59S/H2.5-3P, 59S/H4-3P, 59S/H5-3P, 59S/H2-3P, 59S/H6-3P, 59S/H8-3P	
KM6750-11, KM6750-6, KM6750-7, KM6750-8	
KM6750-10, KM6750-13, K6650-1/4-1P	
KM653-1P	
KSBG18-10DISPEN	
700-1.5-50, 700-1.2-50, 700-1-50, 700-1.8-50	
701-00-50, 701-0-50	
3906-250-24-5P, 3906-250-32-5P	
3735N-4-120	
3734N-2-150, 3734N-4-150, 3734N-6-150	
SBS60-9, SBS60-10, SBS60-11, SBS60-12, SBS60-13, SBS60-4, SBS60-4.5, SBS60-5, SBS60-5.5, SBS60-6, SBS60-7, SBS60-8	
SBS61	
SB6963	
SBS64	
6960-3	
8160-10, 8160-5	
8158-10	
7800SM-20, 7800SM-21, 7800SM-22, 7800SM-23, 7800SM-24, 7800SM-27, 7800SM-12, 7800SM-13, 7800SM-14, 7800SM-15, 7800SM-16, 7800SM-17, 7800SM-18, 7800SM-19, 7800SM-10, 7800SM-11, 7800SM-30, 7800SM-32	
SBS81	
8166	
7772H	

Conjunto de 32 peças numa caixa rígida com rodas



984010320

€ 255 x 390 x 465 mm 814,01 1 984010320

4750RCW01	
2101D-160IP	
224 D	
2630D-180	
2430 D-160 IP	
6M/8C	
8071 C IP	
483-20	
541D-180	
2951-180	
B191.030.075, B191.040.100	
B190.100.200, B190.065.150	
B192.001.100, B192.002.125	
SC127	
2820EF2	
BE-9777	
MTB-3-16	

Conjunto de 32 peças numa caixa rígida



983100320

€ 210 x 415 x 460 mm 562,20 1 983100320

4750RC02	
2101D-160IP	
224 D	
2430 D-160 IP	
8071 C IP	
483-20	
541D-180	
2951-180	
B191.030.075, B191.040.100	
B190.100.200, B190.065.150	
B192.001.100, B192.002.125	
SC127	
2820EF2	
BE-9777	
MTB-3-16	
2630DC-180IP	
6M/8C	

Conjunto de 32 peças numa caixa rígida



983000320

€ 162 x 380 x 435 mm 525,98 1 983000320

4750RC01	
2101D-160IP	
224 D	
2630D-180	
2430 D-160 IP	
8071 C IP	
483-20	
541D-180	
2951-180	
6M/8C	
B191.030.075, B191.040.100	
B190.100.200, B190.065.125	
B192.001.100, B192.002.125	
SC127	
2820EF2	
BE-9777	
MTB-3-16	



Conjunto de ferramentas para electrónica



2010

		€		
109	480 x 180 x 330 mm	3.208,08	1	2010

1952M-6, 1952M-7, 1952M-8, 1952M-9, 1952M-10, 1952M-11, 1952M-12, 1952M-13, 1952M-14	
4020L-M-3, 4020L-M-3.2, 4020L-M-3.5, 4020L-M-4, 4020L-M-4.5, 4020L-M-5.5	
BE-8340, BE-8350, BE-8355	
700-1.5-50, 700-1.2-50, 700-1-50, 700-1.8-50	
3659/8T	
5550-3.2, 5550-4.5	
BE-8220S, BE-8050S, BE-8255S	
5516 I	
5577-145	
5418	
2535L	
3524	
2648	
1150-1/2H/P	
1952Z-1/4, 1952Z-3/8, 1952Z-1/2	
BE-8620S	
BE-7845, BE-7806	
701-0-50, 701-00-50	
8045LVDE	
5574-145	
2-470-16-1-0x 6	
5515GV	
5423	
2665 B-160	
326000300	
328000000	
2656 R	
BE-3529	
BE-6400M-4, BE-6400M-5, BE-6400M-5.5, BE-6400M-7	
BE-8160	
BE-8600, BE-8610	

1995LM-1.5, 1995LM-2, 1995LM-2.5, 1995LM-3, 1995LM-4	
1997M/10T	
2047-0.8-4, 2047-1-5.5	
2421 D-140IP	
2430 GC-200 IP	
2530-40	
2744	
4750RC021	
7372I-2.5-75	
8070 C	
2223 S-150	

Caixa rígida reforçada de 4 gavetas, com rodas



4750RCWD4

	€		
453 x 340 x 575 mm	777,48	1	4750RCWD4
453 x 340 x 575 mm	777,48	1	4750RCWD4-OR

Caixas rígidas de uso intensivo com rodas 153,9 L



4750RCHDW10

	€		
460 x 560 x 860 mm	687,46	1	4750RCHDW10

Caixa rígida reforçada com rodas



4750RCHDW02

	€		
290 x 480 x 630 mm	510,75	1	4750RCHDW02
290 x 480 x 630 mm	510,75	1	4750RCHDW02RED

60x37mm rodas de rolamentos de esferas

Caixa rígida reforçada com rodas



4750RCHDW01

	€		
240 x 350 x 545 mm	325,43	1	4750RCHDW01
240 x 350 x 545 mm	325,43	1	4750RCHDW01RED

60x20 rodas de rolamentos de esferas para transporte fácil mesmo com muita carga

Caixa rígida reforçada



4750RCHD01

	€		
215 x 415 x 465 mm	281,55	1	4750RCHD01

Mala de ferramentas indestrutível com polipropileno copolímero injetado de resina estrutural

Caixa rígida reforçada com divisórias



4750RCHD011

	€		
215 x 415 x 465 mm	458,35	1	4750RCHD011

Caixas rígidas



4750RC02

	€		
221 x 406 x 485 mm	257,53	1	4750RC02
221 x 406 x 485 mm	292,82	1	4750RC021

4750RC02: Com bolsas transparentes de um lado 4750RC021: Com tiras de borracha de um lado

Rotação sob maleta com divisórias - sistema de bolsas



4750RCWD-AC2

	€		
30 x 277 x 507 mm	74,04	1	4750RCWD-AC2

Caixa rígida reforçada



4750RCHD00

	€		
205 x 345 x 400 mm	222,13	1	4750RCHD00

Caixa rígida com sistema elástico



4750RC01

	€		
165 x 399 x 450 mm	216,87	1	4750RC01

Rotação sob maleta com divisórias - elásticos fixos



4750RCWD-AC3

	€		
5 x 277 x 507 mm	74,04	1	4750RCWD-AC3

Caixas rígidas com rodas



4750RCW01

	€		
257 x 406 x 485 mm	515,07	1	4750RCW01
257 x 406 x 485 mm	554,61	1	4750RCW011

4750RCW01 com bolsas transparentes. 4750RCW011 Com tiras de borracha na tampa e no fundo da paleta

Conjunto de rodas giratórias (x4) 50x18mm



4750RCWD-AC1

	€		
100 x 50 x 200 mm	80,21	1	4750RCWD-AC1

Fixo sob maleta com divisórias - elásticos ajustáveis



4750RCWD-AC4

	€		
4 x 286 x 490 mm	55,54	1	4750RCWD-AC4



Painel com tampa almofadada amovível para 4750RCHD01



4750RCHD01AC1

	€		
35 x 305 x 425 mm	52,38	1	4750RCHD01AC1

Saco almofadado amovível para 4750RCHD01



4750RCHD01AC2

	€		
135 x 360 x 450 mm	124,42	1	4750RCHD01AC2

Painel com tampa amovível para 4750RCHD01



4750RCHD01AC1

	€		
50 x 204 x 500 mm	52,38	1	4750RCHD01AC1

Saco interior para 4750RCHDW01



4750RCHDW01AC2

	€		
120 x 280 x 525 mm	124,42	1	4750RCHDW01AC2

Fecho TSA para estojos 4750RCHD



4750RCHD-AC1

	€		
20 x 40 x 70 mm	37,97	1	4750RCHD-AC1

FF2A07 para mala 4750RCHD01, 64 peças



FF2A07

	€		
45 x 330 x 430 mm	1.004,15	1	FF2A07

A6700DZ-1/2, A6700DZ-1/4, A6700DZ-11/32, A6700DZ-3/16, A6700DZ-3/8, A6700DZ-5/16, A6700DZ-7/16, A6700DZ-7/32, A6700DZ-9/16, A6700DZ-9/32

A6710DZ-3/8, A6710DZ-5/16, A6710DZ-7/16, A6710DZ-1/4		
A6800DZ-1/2, A6800DZ-1/4, A6800DZ-11/32, A6800DZ-3/16, A6800DZ-3/8, A6800DZ-5/16, A6800DZ-7/16, A6800DZ-7/32, A6800DZ-9/16, A6800DZ-9/32		
A7400DZ-1/2, A7400DZ-11/16, A7400DZ-13/16, A7400DZ-19/32, A7400DZ-3/4, A7400DZ-3/8, A7400DZ-5/8, A7400DZ-7/16, A7400DZ-7/8, A7400DZ-9/16		
A7402DZ-1/2, A7402DZ-11/16, A7402DZ-13/16, A7402DZ-19/32, A7402DZ-3/4, A7402DZ-3/8, A7402DZ-5/8, A7402DZ-7/16, A7402DZ-7/8, A7402DZ-9/16		
2058-BR		
6950SL		
6954		
6956		
6960, 6962, 6962L		
6966		
6972H		
7407H, 7408H		
7750SL		
7752		
7760, 7761, 7762		
7764		
7765		
7766		
8164-1/2		

Espuma FF2A08 para mala 4750RCHD01, 24 peças



FF2A08

	€		
45 x 335 x 435 mm	447,64	1	FF2A08

1-100-04-2-2		
1-230-04-2-2		
111Z-1, 111Z-1/2, 111Z-1/4, 111Z-11/16, 111Z-3/4, 111Z-3/8, 111Z-5/16, 111Z-5/8, 111Z-7/16, 111Z-9/16, 111Z-7/8		
1177-SCRIBE		
1320RZ-1/2-9/16, 1320RZ-1/4-5/16, 1320RZ-3/8-7/16, 1320RZ-5/16-11/32		
1931Z-1/4, 1931Z-3/16, 1931Z-7/32		
1950MZ-3/8		
208		
9031 C		

Espuma FF2A09 para mala 4750RCHD01, 56 peças



FF2A09

	€		
45 x 335 x 440 mm	517,04	1	FF2A09

BE-8040, BE-8210	
BE-8260	
BE-8600, BE-8610, BE-8620	
BE-9780	
MTB-3-16-E	
2047-1-5.5	
2047PR-1-2	
59/S28-4	
2509	
2535F2	
5515T-52	
808050	
1179-FLX-2, BFLA01	
BE-8150	

Espuma FF2A10 para mala 4750RCHD01, 15 peças



FF2A10

	€		
49 x 330 x 435 mm	551,82	1	FF2A10

2101GC-160IP	
2427 GC-200IP	
2628 GC-160IP	
2632	
2650	
2855	
2979 D-180	
3625N-32	
3734-2, 3734-3, 3734-4, 3734-5	
3735-4-120	
481-300	
8224CIP	

FF2B01 para mala 4750RCHD01, 61 peças



FF2B01

	€		
40 x 270 x 505 mm	971,98	1	FF2B01

A6700DZ-1/2, A6700DZ-1/4, A6700DZ-11/32, A6700DZ-3/16, A6700DZ-3/8, A6700DZ-5/16, A6700DZ-7/16, A6700DZ-7/32, A6700DZ-9/16, A6700DZ-9/32	
A6800DZ-1/2, A6800DZ-1/4, A6800DZ-11/32, A6800DZ-3/16, A6800DZ-3/8, A6800DZ-5/16, A6800DZ-7/16, A6800DZ-7/32, A6800DZ-9/16, A6800DZ-9/32	
A7400DZ-1/2, A7400DZ-1/4, A7400DZ-11/16, A7400DZ-17/32, A7400DZ-19/32, A7400DZ-3/4, A7400DZ-3/8, A7400DZ-5/16, A7400DZ-5/8, A7400DZ-7/16, A7400DZ-9/16	
A7402DZ-1/2, A7402DZ-1/4, A7402DZ-11/16, A7402DZ-19/32, A7402DZ-3/4, A7402DZ-3/8, A7402DZ-5/16, A7402DZ-5/8, A7402DZ-7/16, A7402DZ-9/16	
6950SL	
6954	
6956	
6958	
6960, 6961, 6962L	
6966	
6972H	
7407H	
7750SL	
7752	
7760, 7761, 7762	
7764	
7765	
7766	
8164-1/2	
U-S6106KA	

FF2B02 para mala 4750RCHD01, 69 peças



FF2B02

	€		
39 x 270 x 505 mm	729,97	1	FF2B02

A6700DM-5.5, A6700DM-6, A6700DM-11, A6700DM-12, A6700DM-13, A6700DM-14, A6700DM-7, A6700DM-8, A6700DM-9, A6700DM-10	
A6800DM-6, A6800DM-7, A6800DM-8, A6800DM-9, A6800DM-4, A6800DM-5, A6800DM-5.5, A6800DM-14, A6800DM-10, A6800DM-11, A6800DM-12, A6800DM-13	
A7400DM-10, A7400DM-14, A7400DM-15, A7400DM-16, A7400DM-11, A7400DM-12, A7400DM-17, A7400DM-18, A7400DM-19, A7400DM-13	
A7402DM-19, A7402DM-15, A7402DM-16, A7402DM-17, A7402DM-18, A7402DM-11, A7402DM-12, A7402DM-13, A7402DM-14, A7402DM-10	
BE-9770	
111M-24, 111M-6, 111M-7, 111M-12, 111M-13, 111M-14, 111M-15, 111M-8, 111M-9, 111M-10, 111M-11, 111M-22, 111M-16, 111M-17, 111M-18, 111M-19	
4020L-M-5, 4020L-M-5.5	

FF2B03 para mala 4750RCHD01, 44 peças



FF2B03

	€		
35 x 270 x 505 mm	796,43	1	FF2B03

A6710DM-7	
A6710DZ-1/2, A6710DZ-1/4, A6710DZ-11/32, A6710DZ-3/16, A6710DZ-3/8, A6710DZ-5/16, A6710DZ-7/16, A6710DZ-7/32, A6710DZ-9/16, A6710DZ-9/32	
BE-9780	
111Z-1, 111Z-1/2, 111Z-1/4, 111Z-11/16, 111Z-3/4, 111Z-3/8, 111Z-5/16, 111Z-5/8, 111Z-7/16, 111Z-7/8, 111Z-9/16, 111Z-13/16	
1320RZ-1/2-9/16, 1320RZ-1/4-5/16, 1320RZ-3/8-7/16, 1320RZ-5/16-11/32	
1931Z-1/4, 1931Z-3/16, 1931Z-7/32	
1950MZ-3/8	
2058-BR	



FF2B04 para mala 4750RCHDW01, 45 peças



FF2B04

	€		
42 x 270 x 505 mm	450,70	1	FF2B04

BE-8020L, BE-8040		
BE-8080-10		
BE-8150, BE-8255		
BE-8610, BE-8620		
1544		
2509		
59/S28-4		
2535F2		
5516		
700-1.5-50, 700-1-50		
701-0-50, 701-00-50		
808050		
9070C		

FF2B05 para mala 4750RCHDW01, 15 peças



FF2B05

	€		
35 x 270 x 510 mm	743,46	1	FF2B05

1150-1/2H/P		
MTB-3-16-M-E		
2101GC-125IP, 2101GC-160IP		
2427 GC-200IP		
2628 GC-160IP		
2650		
2820EF2		
2855		
4130		
4830		
5515T-52		
8224CIP		
BFLA01, 1179-FLX-2		

FF2B06 para mala 4750RCHDW01, 6 peças



FF2B06

	€		
35 x 122 x 355 mm	107,02	1	FF2B06

3625N-32		
3734-5, 3734-8, 3734-3		
3735-5-120		
481-300		

FF2B07 para mala 4750RCHDW01, 62 peças



FF2B07

	€		
35 x 270 x 505 mm	958,62	1	FF2B07

A6700DZ-1/2, A6700DZ-1/4, A6700DZ-11/32, A6700DZ-3/16, A6700DZ-3/8, A6700DZ-5/16, A6700DZ-7/16, A6700DZ-7/32, A6700DZ-9/16, A6700DZ-9/32		
A6710DZ-3/8, A6710DZ-5/16, A6710DZ-7/16		
A6800DZ-1/2, A6800DZ-1/4, A6800DZ-11/32, A6800DZ-3/16, A6800DZ-3/8, A6800DZ-5/16, A6800DZ-7/16, A6800DZ-7/32, A6800DZ-9/16, A6800DZ-9/32		
A7400DZ-1/2, A7400DZ-11/16, A7400DZ-13/16, A7400DZ-19/32, A7400DZ-3/4, A7400DZ-3/8, A7400DZ-5/8, A7400DZ-7/16, A7400DZ-7/8, A7400DZ-9/16		
A7402DZ-1/2, A7402DZ-11/16, A7402DZ-13/16, A7402DZ-19/32, A7402DZ-3/4, A7402DZ-3/8, A7402DZ-5/8, A7402DZ-7/16, A7402DZ-7/8, A7402DZ-9/16		
6950SL		
6954		
6956		
6960, 6962, 6962L		
6966		
6972H		

7407H, 7408H

7750SL		
7752		
7760, 7761, 7762		
7764		
7765		
7766		
8164-1/2		

FF2B08 para mala 4750RCHDW01, 25 peças



FF2B08

	€		
44 x 270 x 505 mm	447,85	1	FF2B08

1-100-04-2-2		
1-230-04-2-2		
111Z-1, 111Z-1/2, 111Z-1/4, 111Z-11/16, 111Z-3/4, 111Z-3/8, 111Z-5/16, 111Z-5/8, 111Z-7/16, 111Z-7/8, 111Z-9/16		
1177-SCRIBE		
1320RZ-1/2-9/16, 1320RZ-1/4-5/16, 1320RZ-3/8-7/16, 1320RZ-5/16-11/32		
1931Z-1/4, 1931Z-3/16, 1931Z-7/32		
1950MZ-3/8		
2058-BR		
208		
9031 C		

FF2B09 para mala 4750RCHDW01, 56 peças



FF2B09

	€		
47 x 270 x 505 mm	532,97	1	FF2B09

BE-8040, BE-8210		
BE-8150		
BE-8260		
BE-8600, BE-8610, BE-8620		
BE-9780		

MTB-3-16-E	
2047-1-5.5	
2047PR-1-2	
2509	
2535F2	
5515T-52	
59/S28-4	
BFLA01, 1179-FLX-2	
808050	

FF2B10 para mala 4750RCHDW01, 9
peças



FF2B10

	€		
37 x 270 x 505 mm	496,29	1	FF2B10

2101GC-160IP	
2427 GC-200IP	
2430 GC-200 IP	
2628 GC-160IP	
2650	
2744	
2855	
2979 D-180	
8224CIP	

FF2B11 para mala 4750RCHDW01, 7
peças



FF2B11

	€		
39 x 122 x 355 mm	123,82	1	FF2B11

2632	
3625N-32	
3734-2, 3734-3, 3734-4, 3734-5	
481-300	

FF2B12 para mala 4750RCHDW01, 92
peças



FF2B12

	€		
44 x 270 x 505 mm	1.081,98	1	FF2B12

A6800DM-6, A6800DM-7, A6800DM-8, A6800DM-9, A6800DM-5.5, A6800DM-10, A6800DM-11, A6800DM-12, A6800DM-13	
--	--

A7402DM-19, A7402DM-15, A7402DM-16, A7402DM-17, A7402DM-18, A7402DM-11, A7402DM-12, A7402DM-13, A7402DM-14, A7402DM-10	
--	--

6700SM-5.5, 6700SM-6, 6700SM-11, 6700SM-12, 6700SM-13, 6700SM-7, 6700SM-8, 6700SM-9, 6700SM-10	
--	--

6709M-3, 6709M-4, 6709M-5, 6709M-6, 6709M-8	
--	--

6709PH-1, 6709PH-2, 6709PH-3	
------------------------------	--

6709TORX-T20, 6709TORX-T25, 6709TORX-T27, 6709TORX-T30, 6709TORX-T8, 6709TORX-T9, 6709TORX-T10, 6709TORX-T15, 6709TORX-T40	
--	--

6954	
------	--

6956	
------	--

6958	
------	--

6960, 6961, 6962, 6962L	
-------------------------	--

6966	
------	--

6972H	
-------	--

7400SM-6, 7400SM-11, 7400SM-12, 7400SM-13, 7400SM-14, 7400SM-7, 7400SM-8, 7400SM-9, 7400SM-10, 7400SM-19, 7400SM-22, 7400SM-15, 7400SM-16, 7400SM-17, 7400SM-18	
---	--

7407H	
-------	--

7409M-8, 7409M-10, 7409M-4, 7409M-5, 7409M-6, 7409M-7, 7409M-3	
---	--

7409TORX-T25, 7409TORX-T27, 7409TORX-T30, 7409TORX-T40, 7409TORX-T45, 7409TORX-T50	
--	--

7750SL	
--------	--

7761, 7762, 7760	
------------------	--

7764	
------	--

7765	
------	--

7766	
------	--

8164-1/2	
----------	--

6950SL	
--------	--

FF2B13 para mala 4750RCHDW01, 39
peças



FF2B13

	€		
50 x 270 x 505 mm	489,81	1	FF2B13

BE-9770	
---------	--

111M-12, 111M-13, 111M-14, 111M-15, 111M-8, 111M-9, 111M-10, 111M-11, 111M-6, 111M-7, 111M-21, 111M-22, 111M-16, 111M-17, 111M-18, 111M-19	
---	--

6M-6-7, 6M-8-9, 6M-10-11, 6M-12-13, 6M-14-15, 6M-16-17, 6M-18-19, 6M-20-22	
---	--

9070C	
-------	--

1177-SCRIBE	
-------------	--

2535F2	
--------	--

BFLA01	
--------	--

7758	
------	--

7754	
------	--

FF2B14 para mala 4750RCHDW01, 48
peças



FF2B14

	€		
35 x 270 x 505 mm	342,44	1	FF2B14

BE-8020L, BE-8030	
-------------------	--

BE-8155	
---------	--

BE-8260	
---------	--

BE-8350	
---------	--

BE-8601, BE-8602	
------------------	--

BE-8610, BE-8620	
------------------	--

BE-8630	
---------	--

1544	
------	--

2047-0.8-4	
------------	--

2047PR-1-2	
------------	--

2058-BR	
---------	--

2509	
------	--

808050P	
---------	--

808050S	
---------	--

59S/31-1	
----------	--



FF2B15 para mala 4750RCHDW01, 9 peças



FF2B15

	€		
35 x 270 x 505 mm	343,35	1	FF2B15

1150-1/2H/P	
2101GC-160IP	
2427 GC-200IP	
2430 GC-200 IP	
2628 GC-160IP	
2820EF2	
5515T-52	
8224CIP	
MTB-3-16-M-E	

FF2B16 para mala 4750RCHDW01, 6 peças



FF2B16

	€		
34 x 122 x 355 mm	85,23	1	FF2B16

3625W-35	
3734-3, 3734-5, 3734-8	
3735-4-120	
481-300	

ARMÁRIOS E PAINÉIS

Armário persiana 1495CS18 + 981001100 (ganchos incl.)



1495CS18TS1

	€		
900 x 170 x 1800 mm	2.227,89	1	1495CS18TS1

1495CS18	
981001100	
1495CS-AC1	
1495TP-AC10	

Armário persiana 1495CS15 + 981001100 (ganchos incl.)



1495CS15TS1

	€		
900 x 170 x 1500 mm	2.111,19	1	1495CS15TS1

1495CS15	
981001100	
1495CS-AC1	
1495TP-AC10	

Armário portas 1495CD60 + 981001100 (ganchos incl.)



1495CD60TS1

	€		
900 x 250 x 602 mm	1.961,83	1	1495CD60TS1

1495CD60	
981001100	
1495CD-AC1	
1495TP-AC10	

Espuma FF3A11 para caixas 1483K & 1483KHD, 12 peças



FF3A11

	€		
39 x 205 x 445 mm	338,31	1	FF3A11

1150-1/2H/P	
MTB-3-16	
1177-SCRIBE	
2101GC-160IP	
2427 GC-200IP	
2430 GC-200 IP	
2628 GC-160IP	
3734-3, 3734-5, 3734-8	
3735-4-120	
8224CIP	

Espuma FF3A12 para caixas 1483K & 1483KHD, 28 peças



FF3A12

45 x 205 x 450 mm € 368,33 1 FF3A12

111M-6, 111M-21, 111M-19, 111M-18, 111M-22, 111M-13, 111M-12, 111M-11, 111M-10, 111M-17, 111M-16, 111M-15, 111M-14, 111M-9, 111M-8, 111M-7	
2820EF2	
5515T-52	
6M-10-11, 6M-6-7, 6M-12-13, 6M-8-9, 6M-14-15, 6M-16-17, 6M-18-19, 6M-20-22	
BFLA01	
9070C	

Espuma FF3A13 para caixas 1483K & 1483KHD, 49 peças



FF3A13

68 x 245 x 525 mm € 673,95 1 FF3A13

111M-27, 111M-32, 111M-24, 111M-30	
6M-24-27, 6M-30-32	
7800SM-19, 7800SM-18, 7800SM-17, 7800SM-16, 7800SM-22, 7800SM-21, 7800SM-11, 7800SM-10, 7800SM-15, 7800SM-14, 7800SM-13, 7800SM-12, 7800SM-27, 7800SM-32, 7800SM-30, 7800SM-24	
7807H	
7809M-10, 7809M-12, 7809M-14, 7809M-19, 7809M-17, 7809M-5, 7809M-8, 7809M-6, 7809M-7	
7809TORX-T50, 7809TORX-T45, 7809TORX-T60, 7809TORX-T55, 7809TORX-T25, 7809TORX-T20, 7809TORX-T40, 7809TORX-T30, 7809TORX-T27	

8150SL	
8164-1/2	
8154-11	
8160-5, 8160-10	
8171	
8166	
8172	

Espuma FF3A14 para caixas 1483K & 1483KHD, 86 peças



FF3A14

65 x 247 x 510 mm € 917,32 1 FF3A14

A6700DZ-1/2, A6700DZ-1/4, A6700DZ-3/8, A6700DZ-5/16, A6700DZ-7/16, A6700DZ-7/32, A6700DZ-9/16, A6700DZ-9/32, A6700DZ-11/32	
A6800DZ-1/4, A6800DZ-5/16, A6800DZ-7/32, A6800DZ-9/32	
A7400DM-10, A7400DM-13	
A7400DZ-1/2, A7400DZ-11/16, A7400DZ-13/16, A7400DZ-3/4, A7400DZ-5/8, A7400DZ-7/8, A7400DZ-9/16	
A7402DZ-1/2, A7402DZ-3/8, A7402DZ-7/16, A7402DZ-9/16	
111Z-1, 111Z-1.1/8	
59/S28-4	
6Z-1.1/16-1.1/4, 6Z-1-1.1/8	
6Z/8C	
6950SL	
6958	
6960, 6961	
6966	
6972H	
7407H, 7408H	
7750SL	
7752	
7760, 7761	
7764	
7765	
7766	
7800DZ-1, 7800DZ-15/16	
8164-1/2	
1952Z-15/16	
8171	

Espuma FF3A15 para caixas 1483K & 1483KHD, 14 peças



FF3A15

40 x 210 x 445 mm € 259,59 1 FF3A15

BE-3529	
BE-8020L	
BE-8155	
BE-8260	
BE-8601, BE-8602	
BE-8611, BE-8621	
1177-SCRIBE	
2047-1.2-8	
2047PR-1-2	
5515T-52	
1179-FLX-2	
9715-14-250	

Espuma FF3A16 para caixas 1483K & 1483KHD, 12 peças



FF3A16

42 x 210 x 445 mm € 461,17 1 FF3A16

MTB-3-16-E	
2101GC-160IP	
2421GC-180IP	
3658A-3, 3658A-5, 3658A-8	
3735-5-120	
3740-150	
8224CIP	
2855 D	
0454800500, BFLB01	



Espuma FF3A17 para caixas 1483K & 1483KHD, 30 peças



FF3A17

	€		
48 x 205 x 450 mm	455,08	1	FF3A17

BE-9780	
KE18-01	
1300Z-1/4-5/16, 1300Z-3/8-7/16	
1320RZ-1/4-5/16, 1320RZ-3/8-7/16	
1931Z-1/4, 1931Z-7/32	
1952Z-1/2, 1952Z-11/16, 1952Z-11/32, 1952Z-13/16, 1952Z-3/4, 1952Z-5/8, 1952Z-7/8, 1952Z-9/16	
2628 GC-180IP	
7758	
U-DS2018A, U-XID1415A, U-XID1618A	

Kits de ferramentas multiusos - 109 peças



981001100

		€		
109	27 kg	1.539,57	1	981001100

1546	
2521GC-160	
2630GC-180IP, 2630GC-200IP	
6M-12-13, 6M-14-15, 6M-10-11, 6M-6-7, 6M-8-9, 6M-20-22, 6M-21-23, 6M-24-27, 6M-25-28	
8150RN-1/2	
8154-1/2, 2421GC-160, 8160-1/2, 8162-1/2, 8166-1/2	
9048-400	
9-469-00-0-0	
1998M/10T	
3733-4	

3734-4	
814-100	
815-2-25, 815-1-100, 815-2-125	
9710-8-150, 9710-6.5-125	
2101GC-200HL	
2800-180	
SC127	
1-100-08-2-2, 1-100-10-2-2	
1150-1/2H/P	
2101D-140IP	
2535F1	
3906-300-24-2P	
2951-250	
2M-6-7, 2M-8-9, 2M-10-11, 2M-12-13, 2M-14-15, 2M-16-17, 2M-18-19, 2M-20-22, 2M-21-23, 2M-24-27	
3645-150-C	
4544-10	
813-3-75, 813-4-100, 813-5.5-125	
1-230-08-1-2	
2430 GC-160 IP	
3735-4-120	
2900-180	
3625W-35	
479-16	
869102500	
1-170-08-2-2	
1-210-08-2-2	
8072 C, 8071 C	
225-PLUS	
2427 GC-200IP	
3640-150-C	
7800DM-18, 7800DM-17, 7800DM-16, 7800DM-11, 7800DM-10, 7800DM-15, 7800DM-14, 7800DM-13, 7800DM-12, 7800DM-19, 7800DM-23, 7800DM-22, 7800DM-21, 7800DM-20, 7800DM-24, 7800DM-26, 7800DM-28, 7800DM-30, 7800DM-32, 7800DM-27	
813VDE-3-100	
6224	

Armário de parede ou de bancada com porta e ganchos



1495CS18HK

	€		
900 x 170 x 1800 mm	838,11	1	1495CS18HK
900 x 170 x 1800 mm	838,11	1	1495CS18BLHK

Armário com porta



1495CS1

	€		
900 x 170 x 1500 mm	688,95	1	1495CS15
900 x 170 x 1800 mm	769,21	1	1495CS18
900 x 170 x 1500 mm	688,95	1	1495CS15BL
900 x 170 x 1800 mm	769,21	1	1495CS18BL

armário de parede com 2 portas



1495CD60

	€		
900 x 250 x 602 mm	508,35	1	1495CD60

armário de 2 portas com rodas



1495CD60W

	€		
1605 x 450 x 625 mm	1.056,83	1	1495CD60W

Painel para kit de ferramentas para reparação auto - 62 peças



1495TP-AUTO-M1

	€		
900 x 25 x 500 mm	1.174,42	1	1495TP-AUTO-M1

1495TP09	
BP910	
BP909TH	
BE-9678	
BE-9675	

29M-30	
2997-250	
1995LM-9, 1995LM-8, 1995LM-6	
3750	
1177-SCRIBE	
K7801M-9, K7801M-10, K7801M-11, K7801M-12, K7801M-13, K7801M-14, K7801M-15, K7801M-16, K7801M-17, K7801M-18, K7801M-19, K7801M-21, K7801M-22, K7801M-23, K7801M-24, K7801M-30, K7801M-32	
K7806M-15, K7806M-21, K7806M-24, K7806M-27	
K8901M-32, K8901M-34, K8901M-36	
K8964D	
K8167S	
K8160D-3	
2800-150	
2900-150	
3734S/6	
BE-8258TB	
1495TP-ACHL40x 9, 1495TP-ACHL65x 9, 1495TP-ACHL20x 33	

Painel para kit de ferramentas para reparação auto - 53 peças



1495TP-AUTO-M2

	€		
900 x 25 x 500 mm	2.062,39	1	1495TP-AUTO-M2

1495TP09	
BE301	
K7801TORX-E10, K7801TORX-E12, K7801TORX-E14, K7801TORX-E16, K7801TORX-E18, K7801TORX-E20	
K8160D-2	
BE301CM	
BWHEPSSH8	
BE51038, BE510310, BE510312	
BP822	
BP825	
1495TP-ACHL40x 25, 1495TP-ACHL65x 4, 1495TP-ACHL20x 29	
1495TP-AC4	

Painel para kit de ferramentas para reparação auto - 34 peças



1495TP-AUTO-M3

	€		
900 x 25 x 500 mm	1.145,77	1	1495TP-AUTO-M3

1495TP09	
BE1GP5-T	
6968	
BE1SP1F	
BE6OF108	
BE6307414F	
BE6OFW	
BE1FFWF	
BE63064514F1	
BE6810Z, BE6810	
BE6FCP	
52	
1546	
2421GC-160, 6962-W, 8166-1/2	
5515M	
BE1P	
7455-60	
BE1FLD2, BE1FLD1, BE1FLD3	
BE65F65120	
7764	
8164-1/2	
BE6302712F	
6954	
BE6701VAG	
BE62110	
BE1310P427	
7406ZZ-21, 7406ZZ-16	
BE1SP14L	
BE1GP5	
1495TP-AC3	
1495TP-ACHL20x 38, 1495TP-ACHL40, 1495TP-ACHL65	



Painel para kit de ferramentas para reparação auto - 23 peças



1495TP-AUTO-M4

900 x 25 x 500 mm 1.455,13 1 1495TP-AUTO-M4

1495TP09	
BS618	
4545-N1, 4545-N11	
4545-1, 4545-2	
MTB-3-16	
361-14	
8900SM-41	
BS52	
8169-1/2, 8165-1/2	
747-22, 747-21, 747-19, 747-17, 747-15, 747-14, 747-13, 747-12	
BS40VAG	
BS56	
BS100PSA1	
BS45BMW	
1495TP-ACHL40x 10, 1495TP-ACHL65x 5, 1495TP-ACHL20x 20	

Painel para kit de ferramentas para reparação auto - 32 peças



1495TP-AUTO-M5

900 x 25 x 500 mm 893,70 1 1495TP-AUTO-M5

1495TP09	
319	
484-1000	
SB3654BM-20	
3625S-44	
B192.004.200	
BE-8258TB	
2484/S4	
B194.030.150, B194.025.125, B194.020.100, B194.010.075	
600.005.012	
BBS165	
K7801TORX-E10, K7801TORX-E12, K7801TORX-E14, K7801TORX-E16, K7801TORX-E18, K7801TORX-E20, K7801TORX-E24	
BBR203P920, BBR203P925, BBR203P930, BBR203P940, BBR203P945, BBR203P950, BBR203P955, BBR203P960	
1495TP-ACHL40x 13, 1495TP-ACHL20x 38	
8226	

Painel para kit de ferramentas para reparação auto - 42 peças

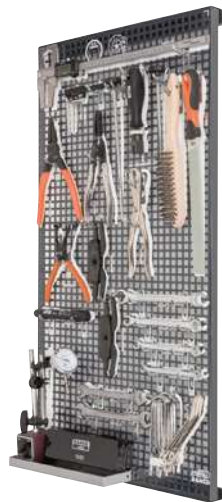

1495TP-AUTO-M6

900 x 25 x 500 mm 1.203,06 1 1495TP-AUTO-M6

1495TP09	
FM10	
782-U	
BBR405	
BBR400	
BBR210P3	
BBR6131	
BBR204	
BBR150I	

BBR501011, BBR50121314	
2900-215	
7823	
BBR100	
1154	
6M-16-17, 6M-14-15	
1949M-17-19, 1949M-12-13, 1949M-10-11, 1949M-8-9	
1495TP-ACHL40x 2, 1495TP-ACHL20x 29	
1495TP-AC3	

Painéis de alta resistência para pendurar ferramentas com estrutura reforçada

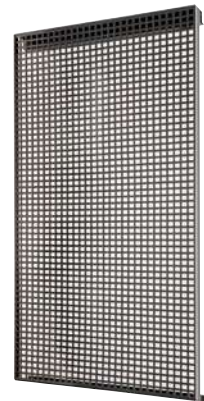

1495TP09

900 x 25 x 500 mm 116,78 1 1495TP09

Painéis de ferramentas

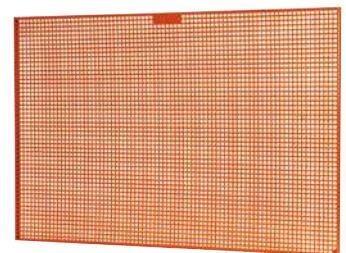

1495TP

500 x 23 x 600 mm	113,71	1	1495TP06
800 x 25 x 1200 mm	167,22	1	1495TP12
800 x 23 x 1500 mm	200,66	1	1495TP15
800 x 23 x 1800 mm	234,11	1	1495TP18
500 x 25 x 600 mm	113,71	1	1495TP06GR
800 x 25 x 1200 mm	167,22	1	1495TP12GR
800 x 25 x 1800 mm	234,11	1	1495TP18GR

Calha para pendurar painéis 1495TP09



1495TP09-RAIL

	€		
40 x 57 x 440 mm	37,13	1	1495TP09-RAIL

Conjunto de ganchos de 35 peças

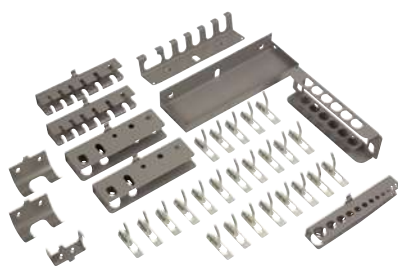

1495CS-AC1

	€		
2.11 kg	120,40	1	1495CS-AC1

Suporte de martelo 70x48x46mm



1495TP-AC12

	€		
0.07 kg	8,30	1	1495TP-AC12

Painel de ferramentas & adaptadores de bancada



1495TP-AC1

	€		
9.5 kg	86,95	1	1495TP-AC1

Suporte de 12 chaves combinadas 165x42x333mm



1495TP-AC10

	€		
0.43 kg	15,39	1	1495TP-AC10

Suporte de cabo em T 56x37x27mm



1495TP-AC13

	€		
0.04 kg	9,70	1	1495TP-AC13

Conjunto de ganchos de 24 peças

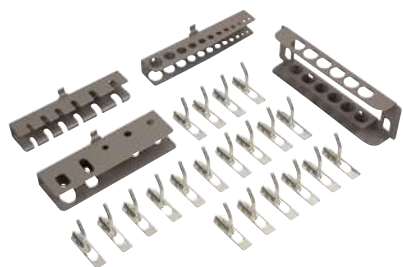

1495CD-AC1

	€		
1.22 kg	80,27	1	1495CD-AC1

Suporte de 6 saca-pinos 213x30x65mm

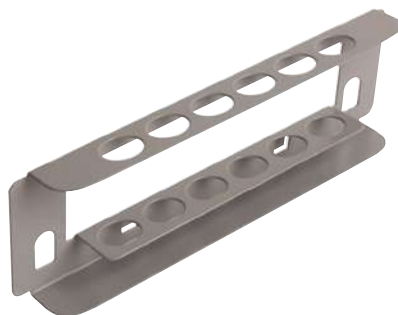

1495TP-AC11

	€		
0.16 kg	6,43	1	1495TP-AC11

Tabuleiro 238x125x40mm



1495TP-AC2

	€		
0.44 kg	12,04	1	1495TP-AC2



Conjunto de gancho e tabuleiro para chaves de caixa 260x80x40mm



1495TP-AC3

kg	€		
0.45 kg	16,38	1	1495TP-AC3

Tabuleiro de plástico 100x90x50mm



1495TP-AC4

kg	€		
0.125 kg	15,05	1	1495TP-AC4

Suporte de 6 chave de fendas 166x30x26mm

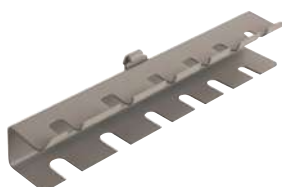

1495TP-AC5

kg	€		
0.14 kg	7,35	1	1495TP-AC5

Suporte de 5 alicates 175x55x26mm



1495TP-AC6

kg	€		
0.17 kg	7,63	1	1495TP-AC6

Suporte do cabo 46x75x36mm



1495TP-AC7

kg	€		
0.79 kg	6,03	1	1495TP-AC7

Suporte de 12 chaves hexagonais 180x33x25mm



1495TP-AC8

kg	€		
0.12 kg	6,95	1	1495TP-AC8

Suporte de 12 chaves de caixa 74x50x398mm



1495TP-AC9

kg	€		
0.43 kg	16,72	1	1495TP-AC9

Ganchos para armários e painéis (x5)



1495TP-ACH

kg	€		
0.116 kg	9,09	1	1495TP-ACHL20
0.125 kg	9,09	1	1495TP-ACHL40
0.144 kg	9,90	1	1495TP-ACHL65
0.17 kg	10,57	1	1495TP-ACHL90
0.102 kg	9,37	1	1495TP-ACHU20
0.125 kg	9,70	1	1495TP-ACHU40
0.146 kg	10,57	1	1495TP-ACHU65
0.162 kg	10,83	1	1495TP-ACHU90

Bancada c/tampo em aço c/armário de gavetas lateral



1495KCWB18TS

	€		
1030 x 750 x 1800 mm	1.591,93	1	1495K6CWB18TS
1030 x 750 x 1800 mm	1.685,57	1	1495K7CWB18TS
1030 x 750 x 1800 mm	1.732,40	1	1495K8CWB18TS
1030 x 750 x 1800 mm	1.591,93	1	1495K6CBKWB18TS
1030 x 750 x 1800 mm	1.685,58	1	1495K7CBKWB18TS
1030 x 750 x 1800 mm	1.732,40	1	1495K8CBKWB18TS
1030 x 750 x 1800 mm	1.591,93	1	1495K6CBLWB18TS
1030 x 750 x 1800 mm	1.685,58	1	1495K7CBLWB18TS
1030 x 750 x 1800 mm	1.732,40	1	1495K8CBLWB18TS
1030 x 750 x 1800 mm	1.591,93	1	1495K6CRDWB18TS
1030 x 750 x 1800 mm	1.685,58	1	1495K7CRDWB18TS
1030 x 750 x 1800 mm	1.732,40	1	1495K8CRDWB18TS

Bancada c/tampo em aço c/armário de gavetas lateral



1495KCWB15TS

	€		
1030 x 750 x 1500 mm	1.525,04	1	1495K6CWB15TS
1030 x 750 x 1500 mm	1.618,69	1	1495K7CWB15TS
1030 x 750 x 1500 mm	1.665,51	1	1495K8CWB15TS
1030 x 750 x 1500 mm	1.525,04	1	1495K6CBKWB15TS
1030 x 750 x 1500 mm	1.618,69	1	1495K7CBKWB15TS
1030 x 750 x 1500 mm	1.665,51	1	1495K8CBKWB15TS
1030 x 750 x 1500 mm	1.525,04	1	1495K6CBLWB15TS
1030 x 750 x 1500 mm	1.618,69	1	1495K7CBLWB15TS
1030 x 750 x 1500 mm	1.665,51	1	1495K8CBLWB15TS
1030 x 750 x 1500 mm	1.525,04	1	1495K6CRDWB15TS
1030 x 750 x 1500 mm	1.618,69	1	1495K7CRDWB15TS
1030 x 750 x 1500 mm	1.665,51	1	1495K8CRDWB15TS

Kit de tampo em aço. p/conv. carrinho série 1475k em bancada de alta resistência



1495KW-TS

	€		
1030 x 750 x 1500 mm	929,74	1	1495KWB15TS
1030 x 750 x 1800 mm	782,58	1	1495KWB18TS

Bancadas com topo em madeira com armário de gavetas lateral



1495KCWB18TW

	€		
1030 x 750 x 1800 mm	1.899,62	1	1495K6CWB18TW
1030 x 750 x 1800 mm	1.993,26	1	1495K7CWB18TW
1030 x 750 x 1800 mm	2.040,08	1	1495K8CWB18TW
1030 x 750 x 1800 mm	1.899,62	1	1495K6CBKWB18TW
1030 x 750 x 1800 mm	1.993,26	1	1495K7CBKWB18TW
1030 x 750 x 1800 mm	2.040,08	1	1495K8CBKWB18TW
1030 x 750 x 1800 mm	1.899,62	1	1495K6CBLWB18TW
1030 x 750 x 1800 mm	1.993,26	1	1495K7CBLWB18TW
1030 x 750 x 1800 mm	2.040,08	1	1495K8CBLWB18TW
1030 x 750 x 1800 mm	1.899,62	1	1495K6CRDWB18TW
1030 x 750 x 1800 mm	1.993,26	1	1495K7CRDWB18TW
1030 x 750 x 1800 mm	2.040,08	1	1495K8CRDWB18TW

Bancadas com topo em madeira com armário de gavetas lateral



1495KCWB15TW

	€		
1030 x 750 x 1500 mm	1.765,84	1	1495K6CWB15TW
1030 x 750 x 1500 mm	1.859,48	1	1495K7CWB15TW
1030 x 750 x 1500 mm	1.665,51	1	1495K8CWB15TW
1030 x 750 x 1500 mm	1.765,84	1	1495K6CBKWB15TW
1030 x 750 x 1500 mm	1.859,48	1	1495K7CBKWB15TW
1030 x 750 x 1500 mm	1.906,30	1	1495K8CBKWB15TW
1030 x 750 x 1500 mm	1.765,84	1	1495K6CBLWB15TW
1030 x 750 x 1500 mm	1.859,48	1	1495K7CBLWB15TW
1030 x 750 x 1500 mm	1.906,30	1	1495K8CBLWB15TW
1030 x 750 x 1500 mm	1.765,84	1	1495K6CRDWB15TW
1030 x 750 x 1500 mm	1.859,48	1	1495K7CRDWB15TW
1030 x 750 x 1500 mm	1.906,30	1	1495K8CRDWB15TW

Conjunto de topo em madeira



1495KWB-TW

	€		
1030 x 750 x 1500 mm	1.130,40	1	1495KWB15TW
1030 x 750 x 1800 mm	1.331,07	1	1495KWB18TW

Bancadas para trabalhos pesados com tampo em aço e bandeja inferior com 4 pernas - 1800 mm



1495WB18TSBT

	€		
1030 x 750 x 1800 mm	941,72	1	1495WB18TSBT
1030 x 750 x 1800 mm	941,72	1	1495WB18TSBLBT

Bancadas para trabalhos pesados com tampo em aço e bandeja inferior com 4 pernas - 1500 mm



1495WB15TSBT

	€		
1030 x 750 x 1500 mm	663,06	1	1495WB15TSBT



Bancadas com topo em aço



1495WB-TS

	€		
1030 x 750 x 1500 mm	702,33	1	1495WB15TS
1030 x 750 x 1800 mm	782,58	1	1495WB18TS
1030 x 750 x 1800 mm	782,58	1	1495WB18TSBK
1030 x 750 x 1500 mm	648,16	1	1495WB15TSBL
1030 x 750 x 1800 mm	782,58	1	1495WB18TSBL
1030 x 750 x 1500 mm	702,33	1	1495WB15TSRED
1030 x 750 x 1800 mm	782,58	1	1495WB18TSRED

Bancadas com topo em madeira



1495WB-TW

	€		
1030 x 750 x 1500 mm	1.130,41	1	1495WB15TW
1030 x 750 x 1800 mm	1.290,93	1	1495WB18TW
1030 x 750 x 1500 mm	1.130,41	1	1495WB15TWGR
1030 x 750 x 1800 mm	1.290,93	1	1495WB18TWGR

Tabuleiro inferior para bancadas



1495WB1-AC

	€		
30 x 504 x 1500 mm	140,46	1	1495WB15-AC1
30 x 504 x 1800 mm	167,22	1	1495WB18-AC1

Gavetas para bancadas



1495WB-AC

	€		
105 x 500 x 500 mm	127,09	1	1495WB-AC1

Bancada dobrável com topo galvanizado & MDF



1495FWBTD

	€		
840 x 510 x 970 mm	529,53	1	1495FWB097TD
840 x 510 x 1200 mm	590,85	1	1495FWB120TD

Bancada dobrável com topo galvanizado



1495FWBTS

	€		
840 x 510 x 1200 mm	406,90	1	1495FWB120TS

CAIXAS DE FERRAMENTAS METÁLICAS

Mala metálica 1483KHD3RB com 129 ferramentas



1483KHD3RB-FF1

	€		
335 x 260 x 565 mm	2.765,44	1	1483KHD3RB-FF1

1483KHD3RB

FF3A01

FF3A02

FF3A03

FF3A04

Mala metálica 1483KHD3RB com 144 ferramentas



1483KHD3RB-FF2

	€		
335 x 260 x 565 mm	2.695,75	1	1483KHD3RB-FF2

1483KHD3RB

FF3A05

FF3A06

FF3A07

FF3A08

2509

2535F2

3625N-32

481-400

7762

Mala metálica 1483KHD3RB com 188 ferramentas



1483KHD3RB-FF3



335 x 260 x 565 mm 2.639,30 1 1483KHD3RB-FF3

1483KHD3RB	
FF3A09	
FF3A10	
FF3A11	
FF3A12	

Mala metálica 1483KHD3RB com 142 ferramentas



1483KHD3RB-FF4



335 x 260 x 565 mm 2.194,40 1 1483KHD3RB-FF4

1483KHD3RB	
FF3A10	
FF3A11	
FF3A12	
FF3A13	

Mala metálica 1483KHD3RB com 142 ferramentas



1483KHD3RB-FF5



335 x 260 x 565 mm 2.637,69 1 1483KHD3RB-FF5

1483KHD3RB	
FF3A14	
FF3A15	
FF3A16	
FF3A17	

Caixa metálica para kit de ferramentas de utilização na indústria de aviação - 124 peças



1483KHD3RB-FF7



335 x 260 x 565 mm 2.005,10 1 1483KHD3RB-FF7

1483KHD3RB	
481-400	
2535F1	

7762	
6950SL	
6960, 6962	
6956	
7752	
6966	
6972H	
A6700DZ-3/16, A6700DZ-7/32, A6700DZ-1/4, A6700DZ-9/32, A6700DZ-5/16, A6700DZ-11/32, A6700DZ-3/8, A6700DZ-7/16, A6700DZ-1/2, A6700DZ-9/16	
A6710DZ-1/4, A6710DZ-5/16, A6710DZ-11/32, A6710DZ-3/8, A6710DZ-7/16	
A6800DZ-3/16, A6800DZ-7/32, A6800DZ-1/4, A6800DZ-9/32, A6800DZ-5/16, A6800DZ-11/32, A6800DZ-3/8, A6800DZ-7/16, A6800DZ-1/2, A6800DZ-9/16	
A6800DM-4	
BE-9780	
59/S28-4	
59S/TS-1/4	
9070 P	
808050	
2058-BR	
KE18-01	
1150-1/2H/P	
2047-1-5.5	
2047PR-1-2	
BE-8030	
BE-8150	
BE-8260	
BE-8350	
BE-8602	
BE-8610, BE-8620	
5515T-52	
1177-SCRIBE	
SR300-E	
704Z-3/32	
MTB-3-16-M-E	
2101GC-160IP	
2427 GC-200IP	
2855	
8224CIP	
2628 GC-160IP	
2632	
3734-3, 3734-5, 3734-8	
1300Z-1/4-5/16	
1320RZ-1/4-5/16, 1320RZ-3/8-7/16	
1952Z-15/16, 1952Z-1, 1952Z-1/4, 1952Z-5/16, 1952Z-11/32, 1952Z-3/8, 1952Z-7/16, 1952Z-1/2, 1952Z-9/16, 1952Z-5/8, 1952Z-11/16, 1952Z-3/4, 1952Z-13/16, 1952Z-7/8	
6Z-19/32-11/16	
3625N-32	



4 gavetas e caixa metálica com tabuleiro superior



1483KHD4RB

390 x 260 x 593 mm 15200 g 641,78 1 1483KHD4RB

3 gavetas e caixa metálica com tabuleiro superior



1483K3RB

334 x 260 x 523 mm 10200 g 401,93 1 1483K3RB

Caixas de ferramentas metálicas de alta resistência com 3 gavetas



1484THD3RB

300 x 220 x 520 mm 12.40 kg 483,90 1 1484THD3RB

2 gavetas e caixa metálica com tabuleiro superior



1483K2RB

277 x 257 x 525 mm 8200 g 330,61 1 1483K2RB

3 gavetas e caixa metálica com tabuleiro superior



1483KHD3RB

305 x 233 x 523 mm 13050 g 544,54 1 1483KHD3RB

Carrinho para caixas metálicas 1483K



1483CART

200 x 270 x 655 mm 6.02 kg 209,80 1 1483CART

Espuma FF3A01 para caixas 1483K & 1483KHD, 93 peças



FF3A01

64 x 245 x 505 mm 968,17 1 FF3A01

A6700DZ-1/2, A6700DZ-1/4, A6700DZ-11/32, A6700DZ-3/8, A6700DZ-5/16, A6700DZ-7/16, A6700DZ-7/32, A6700DZ-9/32		
A6710DZ-3/8, A6710DZ-5/16, A6710DZ-7/16		
A6800DZ-1/4, A6800DZ-5/16, A6800DZ-7/32, A6800DZ-9/32		
A7400DM-10, A7400DM-13		
A7400DZ-1/2, A7400DZ-11/16, A7400DZ-3/4, A7400DZ-5/8, A7400DZ-9/16		
A7402DZ-1/2, A7402DZ-3/8, A7402DZ-7/16, A7402DZ-9/16		
1320RZ-1/4-5/16, 1320RZ-3/8-7/16		
59/S28-4		
6Z-1.1/16-1.1/4, 6Z-1-1.1/8, 6Z-7/8-15/16		
6950SL		
6956		
6958		
6960, 6961		
6966		
6972H		
7407H		
7750SL		
7752		
7760, 7761		
7764		
7765		
7766		
7800DZ-1, 7800DZ-13/16, 7800DZ-7/8		
8164-1/2		
8171		

Espuma FF3A02 para caixas 1483K & 1483KHD, 13 peças



FF3A02

	€		
39 x 210 x 445 mm	269,26	1	FF3A02

BE-3529	
BE-8020L	
BE-8155	
BE-8260	
BE-8601	
BE-8611, BE-8621	
1150-1/2H/P	
1177-SCRIBE	
2047-1.2-8	
2047PR-1-2	
5515T-52	
9715-14-250	

Espuma FF3A03 para caixas 1483K & 1483KHD, 12 peças



FF3A03

	€		
48 x 210 x 450 mm	469,09	1	FF3A03

MTB-3-16-M-E	
2101GC-160IP	
2421GC-180IP	
2855 D	
3658A-2, 3658A-3, 3658A-5	
8224CIP	
0454800500, 1151-1, 1151-2, BFLB01	

Espuma FF3A04 para caixas 1483K & 1483KHD, 20 peças



FF3A04

	€		
45 x 210 x 445 mm	514,40	1	FF3A04

U-XID1415A, U-XID1618A, U-DS2018A	
1300Z-1/2-9/16, 1300Z-1/4-5/16, 1300Z-3/8-7/16, 1300Z-5/8-3/4, 1300Z-7/8-15/16, 1300Z-25/32-13/16, 1300Z-19/32-11/16	
6Z-19/32-11/16, 6Z-25/32-13/16, 6Z-3/8-7/16, 6Z-5/8-3/4, 6Z-1/4-5/16, 6Z-1/2-9/16	
9070C	
1931Z-7/32, 1931Z-1/4	
8157-15	

Espuma FF3A05 para caixas 1483K & 1483KHD, 95 peças



FF3A05

	€		
60 x 245 x 510 mm	1.071,23	1	FF3A05

A6700DZ-1/2, A6700DZ-1/4, A6700DZ-11/32, A6700DZ-3/8, A6700DZ-5/16, A6700DZ-7/16, A6700DZ-7/32, A6700DZ-9/16, A6700DZ-9/32	
A6710DZ-1/4, A6710DZ-11/32, A6710DZ-3/8, A6710DZ-5/16, A6710DZ-7/16	
A6800DM-4	
A6800DZ-1/2, A6800DZ-1/4, A6800DZ-11/32, A6800DZ-3/8, A6800DZ-5/16, A6800DZ-7/16, A6800DZ-3/16, A6800DZ-7/32, A6800DZ-9/16, A6800DZ-9/32	

A7400DZ-1/2, A7400DZ-11/16, A7400DZ-13/16, A7400DZ-17/32, A7400DZ-19/32, A7400DZ-3/4, A7400DZ-5/8, A7400DZ-9/16

59/S28-4	
BE-9780	
KE18-01	
1544	
2058-BR	
59S/TS-1/4	
6950SL	
6956	
6960, 6962	
6966	
6972H	
7407H	
7752	
7750SL	
7760, 7761	
7764	
7765	
7766	
808050	
9071C	
8164-1/2	

Espuma FF3A06 para caixas 1483K & 1483KHD, 15 peças



FF3A06

	€		
40 x 205 x 450 mm	286,15	1	FF3A06

BE-8030	
BE-8150, BE-8155	
BE-8260	
BE-8350	
BE-8602	
BE-8610, BE-8620	
1177-SCRIBE	
2047-1-5.5	
2047PR-1-2	
5515T-52	
704Z-3/32	
1150-1/2H/P	
1179-FLX-2	



Espuma FF3A07 para caixas 1483K & 1483KHD, 11 peças



FF3A07

	€		
39 x 202 x 450 mm	467,57	1	FF3A07

MTB-3-16-E	
2101GC-160IP	
2427 GC-200IP	
2628 GC-160IP	
2632	
2650	
2855	
3734-3, 3734-5, 3734-8	
8224CIP	

Espuma FF3A08 para caixas 1483K & 1483KHD, 23 peças



FF3A08

	€		
43 x 205 x 450 mm	371,79	1	FF3A08

1320RZ-1/2-9/16, 1320RZ-5/16-11/32, 1320RZ-1/4-5/16, 1320RZ-3/8-7/16	
1952Z-1/2, 1952Z-1/4, 1952Z-11/16, 1952Z-11/32, 1952Z-13/16, 1952Z-3/4, 1952Z-3/8, 1952Z-5/16, 1952Z-5/8, 1952Z-7/16, 1952Z-7/8, 1952Z-9/16	
6Z-19/32-11/16, 6Z-1/2-9/16, 6Z-1/4-5/16, 6Z-13/16-7/8, 6Z-3/8-7/16, 6Z-5/16-11/32, 6Z-5/8-3/4	

Espuma FF3A0 para caixas 1483K & 1483KHD, 95 peças



FF3A09

	€		
65 x 250 x 515 mm	1.122,25	1	FF3A09

A6800DM-7, A6800DM-6, A6800DM-5.5, A6800DM-11, A6800DM-10, A6800DM-9, A6800DM-8, A6800DM-13, A6800DM-12	
A7402DM-19, A7402DM-18, A7402DM-17, A7402DM-12, A7402DM-11, A7402DM-10, A7402DM-16, A7402DM-15, A7402DM-14, A7402DM-13	
1544	
2058-BR	
6700SM-8, 6700SM-7, 6700SM-6, 6700SM-5.5, 6700SM-12, 6700SM-11, 6700SM-10, 6700SM-9, 6700SM-13	
6709M-8, 6709M-6, 6709M-5, 6709M-4, 6709M-3	
6709PH-2, 6709PH-1, 6709PH-3	
6709TORX-T25, 6709TORX-T20, 6709TORX-T15, 6709TORX-T10, 6709TORX-T40, 6709TORX-T30, 6709TORX-T27, 6709TORX-T9, 6709TORX-T8	
6950SL	
6954	
6956	
6958	
6960, 6961, 6962, 6962L	
6966	
6972H	
7400SM-8, 7400SM-7, 7400SM-6, 7400SM-19, 7400SM-18, 7400SM-17, 7400SM-22, 7400SM-12, 7400SM-11, 7400SM-10, 7400SM-9, 7400SM-16, 7400SM-15, 7400SM-14, 7400SM-13	
7407H	
7409M-10, 7409M-8, 7409M-7, 7409M-6, 7409M-5, 7409M-4, 7409M-3	
7409TORX-T27, 7409TORX-T25, 7409TORX-T50, 7409TORX-T45, 7409TORX-T40, 7409TORX-T30	
7750SL	
7754	
7758	
7760, 7761	
7764	
7765	
7766	
8164-1/2	

Espuma FF3A10 para caixas 1483K & 1483KHD, 53 peças



FF3A10

	€		
39 x 205 x 445 mm	254,58	1	FF3A10

BE-8020L, BE-8030	
BE-8155	
BE-8260	
BE-8350	
BE-8601, BE-8602	
BE-8610, BE-8620	
BE-9770	
2047-0.8-4	
2047PR-1-2	
808050P	
808050S	
59S/31-1	

Caixa metálica Cantilever com espumas para caixa de ferramentas de utilização geral - 69 peças



3149-ORFF1

	€		
220 x 220 x 560 mm	561,43	1	3149-ORFF1

111M-19, 111M-18, 111M-17, 111M-16, 111M-15, 111M-14, 111M-13, 111M-12, 111M-11, 111M-10, 111M-8, 111M-9	
2953-250	
224 D	
2171G-160	
2470 G-200	
BE-9770	
611-3.5-75, 611-5.5-125, 611-6.5-150	
613-3-100, 613-4-125	
615-2-25, 615-1-100, 615-2-125, 615-3-150	
KBSK-01	
MTG-5-19-E	
482-30	
3625W-28	

3745-150	
3740-150	
3734-3, 3734-5	
3735-5-120	
3149-OR	
2678 G-200	
8160-10, 8160-5	
8158-10	
SBS81	
8166	
7772H	
7800SM-15, 7800SM-16, 7800SM-13, 7800SM-14, 7800SM-19, 7800SM-20, 7800SM-17, 7800SM-18, 7800SM-23, 7800SM-24, 7800SM-21, 7800SM-22, 7800SM-27, 7800SM-32, 7800SM-30, 7800SM-11, 7800SM-12, 7800SM-10	

Caixa metálica Cantilever para caixa de ferramentas de utilização geral - 69 peças



3149-ORTS1

	€		
220 x 220 x 560 mm	372,38	1	3149-ORTS1

111M-19, 111M-18, 111M-17, 111M-16, 111M-15, 111M-14, 111M-13, 111M-12, 111M-11, 111M-10, 111M-9, 111M-8	
--	--

S240	
2953-250	
224 D	
2171G-160	
2678 G-200	
2470 G-200	
BE-9770	
611-3.5-75, 611-5.5-125, 611-6.5-150	
613-3-100, 613-4-125	
615-2-25, 615-1-100, 615-2-125, 615-3-150	
KBSK-01	
MTG-5-19-E	
482-30	
3625W-28	
3745-150	
3740-150	
3734-3, 3734-5	
3735-5-120	
3149-OR	

Caixa de ferramentas metálica com rodas



1497MBW

		€		
549 x 400 x 1213 mm	250 kg	573,39	1	1497MBW

Caixas de ferramentas



3149-OR

		€		
200 x 220 x 530 mm	4370 g	45,14	1	3149-OR

Caixa de ferramentas estilo consola com 7 compartimentos



1497MBF750

		€		
250 x 200 x 530 mm	15 kg	78,50	1	1497MBF750

Caixa de ferramentas estilo consola com 5 compartimentos



1497MBF550

		€		
200 x 200 x 530 mm	12 kg	69,78	1	1497MBF550

Caixa de ferramentas estilo consola com 3 compartimentos



1497MBF350

		€		
160 x 200 x 530 mm	10 kg	57,90	1	1497MBF350

Caixa de ferramentas metálica



9601

		€		
190 x 210 x 300 mm	2450 g	37,08	1	960100010
190 x 210 x 400 mm	3400 g	40,16	1	960100020
190 x 210 x 500 mm	3670 g	43,65	1	960100030
245 x 210 x 400 mm	4400 g	51,36	1	960100050
245 x 210 x 500 mm	4840 g	55,58	1	960100060



Caixa de pedreiro 530x290x290mm



1496MB2

		€		
290 x 290 x 530 mm	40 kg	130,20	1	1496MB2

Caixa de pedreiro 910x530x430mm



1496MB5

		€		
530 x 530 x 910 mm	150 kg	302,36	1	1496MB5

Caixa de pedreiro 690x360x310mm



1496MB3

		€		
310 x 360 x 690 mm	60 kg	155,02	1	1496MB3

Caixa de pedreiro 830x440x340mm



1496MB4

		€		
340 x 440 x 830 mm	80 kg	186,02	1	1496MB4

Caixas de ferramentas plásticas de alta resistência 670 mm



4750PTBW67

		€		
420 x 472 x 675 mm	50 kg	98,73	1	4750PTBW67

Mala plástico com Chave de Torque ajustável e kit de ferramentas de chave de caixas de impacto - 11 peças



4750BMC10FF1

	€		
84 x 341 x 447 mm	494,40	1	4750BMC10FF1

4750BMC10	
BWSHK21	
BWSMB15	
BWSMB17	
BWSS12P5	
BWTVCTT355	
74W9-200	
9R-1/2	

CAIXAS E ESTOJOS DE PLÁSTICO

Caixa metálica para kit de ferramentas de utilização geral - 37 peças



4750PTB65TS5

	€		
285 x 300 x 650 mm	223,43	1	4750PTB65TS5

2430 D-140 IP	
2630D-160	
MT-TS-3	
9572	
BE-9884	
2446	
SL25	
427-16	

Caixa de ferramentas em plástico



4750PTBW47

		€		
60 l	30 kg	78,26	1	4750PTBW47

Caixas de ferramentas plásticas de alta resistência 650 mm



4750PTB65

	€		
285 x 300 x 650 mm	62,17	2	4750PTB65

Caixa de ferramentas em plástico



4750PTB60

		€		
37 l	20 kg	55,38	3	4750PTB60

Caixa de ferramentas em plástico



4750PTB50

		€		
27 l	20 kg	48,15	3	4750PTB50

Caixas em molde de sopro



4750BMC

	€		
51 x 117 x 260 mm	5,06	1	4750BMC3
67 x 214 x 230 mm	9,11	1	4750BMC4
70 x 230 x 280 mm	12,39	1	4750BMC5
90 x 230 x 320 mm	13,75	1	4750BMC5.5
93 x 257 x 357 mm	15,93	1	4750BMC6
76 x 256 x 355 mm	16,41	1	4750BMC7
80 x 287 x 380 mm	16,76	1	4750BMC9
105 x 297 x 393 mm	21,13	1	4750BMC9.5
84 x 341 x 450 mm	22,43	1	4750BMC10

EQUIPAMENTOS DE TÊXTEIS E CABEDAL

Bolsa 4750FB2W-24A com 72 ferramentas



4750FB2W-TS001

	€		
390 x 400 x 685 mm	670,28	1	4750FB2W-TS001

4750FB2W-24A		
SL25		
BE-8030, BE-8242		
S240		
BE-8155		
BE-8600, BE-8610, BE-8620		
BE-8800, BE-8810, BE-8820		
BE-8040S		
2628 G-180		

2101G-180		
7224		
1520 G		
MTB-5-25		
MA421		
268		
325		
479-16		
KERU-01		
BFLA01		
5515T		
9071		

Bolsa 4750FB2-19A c/61 ferramentas para manutenção



4750FB2-19TS001

		€		
500 mm	250 mm	560,68	1	4750FB2-19TS001

4750FB2-19A		
BE-8010S, BE-8040S, BE-8050S, BE-8220S		
BE-8610S, BE-8620S, BE-8630S		
BE-8800S, BE-8820S, BE-8830S		
706-4		
PC-12-VEN		
1-210-08-2-2		
2101G-180		
2233 D-200		
2628 G-180		
268		
3830-20-VIP, 3830-25-VIP		
3834-ARBR-730		
4130		
424P-16, 424P-20, 424P-25		
428-16		
484-1250		
806-1-1		
8231		
9031		
SL25		



Bolsa 4750FB4-18 com 32 ferramentas



4750FB4-18TS001

		€		
450 mm	190 mm	745,29	1	4750FB4-18TS001

4750FB4-18	
2101G-160	
2628 G-180	
2430 G-160	
1RM/SH8	
7223	
2233 D-200	
SL25	
9070	
9031	
483-20	
BE-8020, BE-8040	
BE-8150, BE-8155	
BE-8610, BE-8620	
SC127	
SQZ150003	
BE-9777	
MTB-5-25	

Mala de manutenção



3049-2

	€		
180 x 435 x 270 mm	538,96	1	3049-2

268	
5470-140	
111M-7, 111M-8, 111M-10, 111M-13	
2744	
2427 S-200	
8045LVDE	
BE-9765	
2705R	
481-300	
9072 P	
2628 S-180	
2101S-160	
BE-8820S	
BE-8220S, BE-8040S, BE-8050S, BE-8255S	
BE-8610S, BE-8620S	
B146.006.100	
4750-FOLTC-1	

Conjunto de 16 peças de eletricitista num saco de couro



982000170

	€		
290 x 195 x 440 mm	574,17	1	982000170

4750-FOLTC-1	
2101GC-160IP	
2800 N	
2630GC-160IP	
2421GC-160	
2521GC-160	
8071 C IP	
B196.065.150, B196.055.125, B196.030.100, B196.040.100	
B197.002.100, B197.001.080	
SC127	
2820EF2	
MTB-3-16	
6224	

Conjunto de 32 peças num saco de couro



982000320

	€		
280 x 200 x 435 mm	574,17	1	982000320

4750-FOLTC-1	
2101D-160IP	
224 D	
2630D-180	
2430 D-160 IP	
8071 C IP	
483-20	
6M/8C	
541D-180	
2951-180	
B191.030.075, B191.040.100	
B190.100.200, B190.065.150	
B192.001.100, B192.002.125	
SC127	
2820EF2	
BE-9777	
MTB-3-16	

Conjunto de 34 peças num saco de couro



982000350

	€		
280 x 200 x 440 mm	647,02	1	982000350

4750-FOLTC-1	
2101GC-160IP	
2630GC-180IP	

2900-180	
2800-180	
1998M/10T	
8072 C IP	
2951-250	
B190.100.200, B190.065.150, B190.040.100	
B192.001.100, B192.002.125	
SC127	
6M/8C	
479-16	
2430 GC-200 IP	
1-110-08-2-2	
6224	

Suporte ferramentas em tecido com espuma, 51 peças



4750FB5BFF1

 62 x 275 x 330 mm 194,78 1 4750FB5BFF1

4750FB5B	
808050P	
MTB-5-25	
2101G-160	
2628 G-180	
BE-9578	
9070	
59/S31B	

Suporte de ferramentas em tecido, 36 peças



4750FB5ATS001

 275 mm 170 mm 131,76 1 4750FB5ATS001

4750FB5A	
2058/S26	
808050	
8070	
2101G-160	
2628 G-180	

Kit de serviço de elevada qualidade, alicates, chaves de parafusos, pinças, chave inglesa. pinças, chave inglesa



9848

 50 x 275 x 330 mm 159,03 1 9848

8160	
7890	
8070	
BE-8020, BE-8040	
BE-8610	
TL AA-SA-SL	

Conjunto de ferramentas com 17 ferramentas



9852

 360 x 40 x 240 mm 370,64 1 9852

7890	
8160	
8070	
TL AA-SA-SL	

2421 G-160	
2101G-160	
2628 G-180	
BE-8210, BE-8040	
BE-8150, BE-8155	
BE-8600, BE-8610, BE-8620	
8045LVDE	
K-AP-1	

Conjunto de ferramentas, alicates, chaves de parafusos, pinças, chave inglesa. pinças, chave inglesa



9841

 275 x 48 x 330 mm 176,37 1 9841

7190	
7890	
TL AA-SA-SL	
BE-8020, BE-8040	
BE-8610	
8070	

Mochila com base de plástico rígido antiderrapante



4750FB8

 560 x 190 x 335 mm 100,73 4 4750FB8



Saco de ferramentas



3100TB

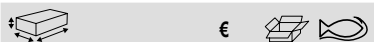

345 x 240 x 485 mm € 61,13 1 3100TB

Saco de 19"



4750FB2-19A



370 x 230 x 470 mm € 64,91 4 4750FB2-19A

Bolsa de electricista de 12"



4750FB3-12



285 x 190 x 285 mm € 79,72 1 4750FB3-12

Saco aberto de 19"



4750FB1-19A



355 x 230 x 470 mm € 78,60 1 4750FB1-19A

Saco de 24"



4750FB2-24A



380 x 260 x 600 mm € 97,51 2 4750FB2-24A

Saco para ferramentas & portátil de 18"



4750FB4-18



350 x 150 x 430 mm € 109,64 4 4750FB4-18

Saco aberto de 19" com proteção



4750FB1-19B

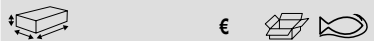

365 x 225 x 480 mm € 107,25 4 4750FB1-19B

Saco de 24" com rodas



4750FB2W-24A



385 x 325 x 665 mm € 192,45 1 4750FB2W-24A

Sacos de ferramentas em tecido de topo fechado de 21 L



4750FB6-13



275 x 250 x 310 mm € 19,20 1 4750FB6-13

Sacos de ferramentas em tecido de topo fechado de 36 L



4750FB6-19

	€		
290 x 265 x 480 mm	26,09	1	4750FB6-19

Suporte de ferramentas em tecido



4750FB5B

	€		
62 x 275 x 330 mm	18,67	1	4750FB5B

Pasta para ferramentas em tecido de 11 L com pega emborrachada para 2x inserções de espuma 1/3 Fit&Go



4750FB5-FG2

	€		
90 x 210 x 470 mm	22,10	1	4750FB5-FG2

Bolsa para conjunto de níveis 416-SET-1



4750-LV-1

	€		
85 x 43 x 1800 mm	10,86	1	4750-LV-1
51 x 43 x 1800 mm	10,87	1	4750-LV-2

Suporte de ferramentas em tecido



4750FB5C

	€		
80 x 305 x 403 mm	24,36	8	4750FB5C

Estojo de couro de ferramentas com abertura à frente



4750-FOLTC-1

	€		
290 x 195 x 440 mm	171,29	1	4750-FOLTC-1

Suporte de ferramentas em tecido



4750FB5A

	€		
50 x 168 x 273 mm	10,63	1	4750FB5A

Pasta para ferramentas em tecido de 8 L com pega emborrachada para 1x inserção de espuma 1/3 Fit&Go



4750FB5-FG1

	€		
65 x 210 x 470 mm	19,11	1	4750FB5-FG1

Tubo de estojo de ferramentas



4750-TOCST-1

	€		
220 x 170 x 495 mm	64,74	1	4750-TOCST-1



Estojo de electricista em couro



4750-VDEC

	€		
290 x 190 x 445 mm	252,79	1	4750-VDEC

Conjunto de 3 bolsas com fecho - 90 mm



4750FB7-01

	€		
135 x 10 x 215 mm	22,23	60	4750FB7-01

Conjunto de 3 bolsas com fecho - 145 mm



4750FB7-02

	€		
205 x 10 x 310 mm	26,29	60	4750FB7-02

Bolsa cor de laranja com fecho - 90 mm



4750FB7ORLT

	€		
135 x 10 x 215 mm	7,85	120	4750FB7ORLT

Bolsa cor de laranja com fecho - 145 mm



4750FB7ORBG

	€		
205 x 10 x 310 mm	8,99	120	4750FB7ORBG

Cinto porta-ferramentas almofadado e com fivela em aço inoxidável



4750-HDB-2

	€		
190 x 50 x 900 mm	51,11	1	4750-HDB-2

Conjunto de cintos porta-ferramentas



4750-HDBS-2

	€		
330 x 170 x 900 mm	162,30	1	4750-HDBS-2

Cinto regulável em tecido de desengate rápido



4750-QRFB-1

	€		
50 x 4 x 1180 mm	21,25	1	4750-QRFB-1

Cinto júnior com 3 bolsas



4750-JU3PB

	€		
125 x 55 x 395 mm	35,63	1	4750-JU3PB-1

Cinto porta-ferramentas em couro



4750-HDLB

	€		
47 x 4 x 1380 mm	32,02	1	4750-HDLB-1

Bolsa com 2 bolsos



4750-2PP

	€		
285 x 130 x 265 mm	45,05	1	4750-2PP-1

Suporte multifunções



4750-MPH-1

	€		
240 x 50 x 155 mm	28,03	1	4750-MPH-1

Bolsa de ferramentas tipo rolo



4750-ROCO-1

	€		
320 x 5 x 370 mm	20,70	1	4750-ROCO-1

Porta brocas para destros e canhotos



4750-DHO-3

	€		
320 x 73 x 175 mm	34,27	1	4750-DHO-3

Suporte de faca



4750-KNHO-1

	€		
205 x 35 x 105 mm	18,21	1	4750-KNHO-1

Joelheiras de chão e de telhado



4750-KP

	€		
200 x 30 x 170 mm	44,43	1	4750-KP-1

Bolsa de electricista



4750-EP

	€		
345 x 120 x 260 mm	56,64	1	4750-EP-1

Suporte vertical para telemóvel



4750-VMFH-1

	€		
170 x 35 x 100 mm	22,40	1	4750-VMFH-1

Suspensórios com grampos



4750-BWC-1

	€		
750 x 20 x 105 mm	29,08	1	4750-BWC-1





BAHCO

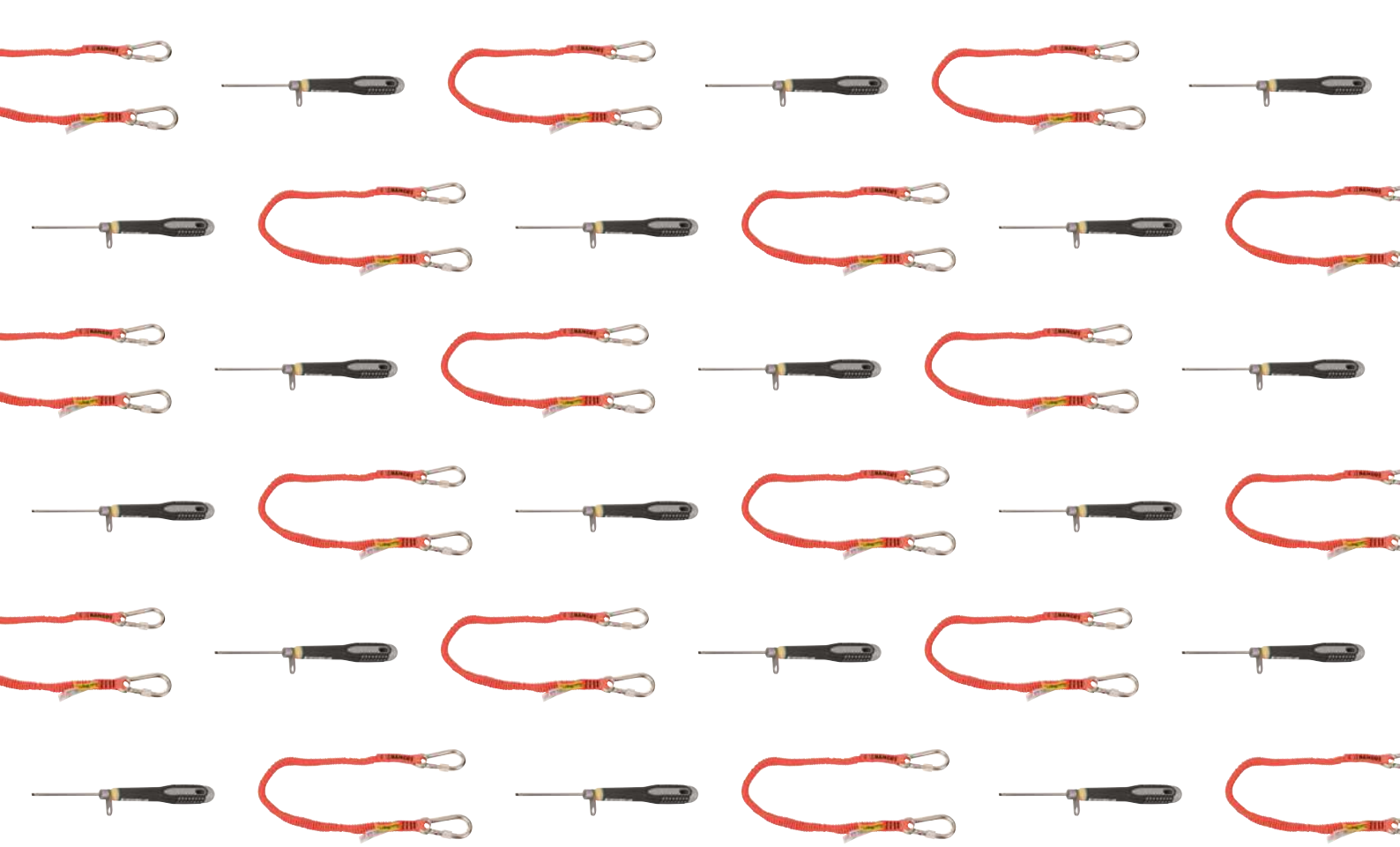

Ferramentas para trabalhos em altura



ARRUMAÇÃO E FITAS PARA FERRAMENTAS

Cordão para 1 kg com mosquetões giratórios



3875-LY60



g	€		
135 g	19,82	1	3875-LY60

Colhedor em laço, permútavel (1daN)



3875-LY3

g	€		
125 g	39,25	8	3875-LY3

Colhedor de pulso (1daN)



3875-WL1

g	€		
40 g	25,62	8	3875-WL1

Conector de colhedor para 3875-LY3 ou 3875-WL1



3875-QL1

g	€		
40 g	15,01	8	3875-QL1

Colhedor retrátil (0,9daN)



3875-RL1

g	€		
200 g	68,07	1	3875-RL1

Encaixe para colhedor para 3875-RL1



3875-QRL1

g	€		
40 g	19,56	1	3875-QRL1

Cordão retrátil para 1 kg



3875-RL2

g	€		
212 g	68,32	1	3875-RL2

Cordão para 3 kg com mosquetões fixos



3875-LY70



g	€		
172 g	24,87	1	3875-LY70

Cordão para 3 Kg com mosquetões fixos e dispositivo de fecho



3875-LY4



g	€		
180 g	40,77	8	3875-LY4

Colhedor Carabiner (3daN)



3875-LY1

g	€		
170 g	39,25	8	3875-LY1

Colhedor em laço, fixo (3daN)



3875-LY2

g	€		
120 g	39,25	8	3875-LY2

Cordão para 6 kg com mosquetões fixos



3875-LY8



	€		
330 g	57,38	1	3875-LY8

Cordão enrolado de 1,7 mm



439000001

	€		
130 g	12,91	1	439000001

Cordão enrolado para 3 kg com mosquetões giratórios



439000003



	€		
160 g	23,42	1	439000003

Cordão para 12 Kg com mosquetões fixos



3875-LY10



	€		
270 g	68,32	1	3875-LY10

Fio de aço



3875-SL1

	€		
10 g	0,68	1	3875-SL1

Cordão cor de laranja de alta visibilidade com clipe de plástico



439000004

	€		
13 g	7,11	1	439000004

Suporte para porta chaves



439000000

	€		
100 g	12,76	1	439000000

Cordão enrolado para 2 kg com mosquetões giratórios



439000002

	€		
130 g	20,51	1	439000002

Bolsa p/trab. em altura 10 litros - 1 kg carga máx.



3875-HB10

	€		
260 x 130 x 130 mm	8,88	1	3875-HB10



Sacos de Elevação com Correas de Elevação Reforçadas



3875-HB30/3875-HB60



Icon	€	Icon	Icon
270 x 270 x 330 mm	91,26	1	3875-HB30
340 x 340 x 620 mm	114,12	6	3875-HB60

Mochilas em Poliéster Durável Tamanho Grande



3875-BP2



Icon	€	Icon	Icon
240 x 340 x 440 mm	127,81	8	3875-BP2

Bolsas Multiusos com 2 Bolsos Grandes e 4 Anéis de Segurança para Fixação de Lanyard



4750-UP-2

Icon	€	Icon	Icon
270 x 145 x 270 mm	60,79	1	4750-UP-2

Sacos de Elevação com Alças de Elevação Duplamente Reforçadas



3875-HB100



Icon	€	Icon	Icon
390 x 390 x 890 mm	184,46	1	3875-HB100

Bolsas com 2 Bolsos Grandes e 6 Anéis de Segurança para Fixação de Lanyard



3875-MHP6

Icon	€	Icon	Icon
100 x 185 x 370 mm	90,80	1	3875-MHP6

Bolsas de Cinto de Martelo com 1 Anel de Segurança para Fixação do Lanyard



4750-HHO-2

Icon	€	Icon	Icon
110 x 65 x 165 mm	21,47	1	4750-HHO-2

Malas rígidas com alças de elevação reforçadas duplamente



3875-SB70



Icon	€	Icon	Icon
790 x 300 x 750 mm	252,78	1	3875-SB70

Três Cintos de Conjunto de Bolsa com 4 Anéis de Segurança para Fixação de Cordão



3PB-2

Icon	€	Icon	Icon
80 x 270 x 1350 mm	129,33	1	4750-3PB-2

Cintos de Segurança Pesados com 6 Anel de Segurança para Fixação de Cordão



4750-HDLB-TAH

Icon	€	Icon	Icon
50 x 120 x 1410 mm	61,58	1	4750-HDLB-TAH

CHAVES DE BOCAS

Chave ajustável, série 90, com ligação rápida



ergo



TAH90



L	W	€	Box	Key
158mm/6"	20 mm	44,59	1	TAH9070
250mm/10"	31 mm	63,04	1	TAH9072

Chave ajustável, série 80, com ligação rápida



TAH80



L	W	€	Box	Key
110mm/4"	13 mm	52,65	1	TAH8069
155mm/6"	20 mm	50,69	1	TAH8070
205mm/8"	27 mm	54,69	1	TAH8071
255mm/10"	31 mm	50,79	1	TAH8072
305mm/12"	34 mm	73,78	1	TAH8073
380mm/15"	44 mm	120,60	1	TAH8074
460mm/18"	53 mm	189,48	1	TAH8075
110mm/4"	13 mm	54,99	1	TAH8069C
155mm/6"	20 mm	39,37	1	TAH8070C
205mm/8"	27 mm	40,77	1	TAH8071C
255mm/10"	31 mm	44,70	1	TAH8072C
305mm/12"	34 mm	54,33	1	TAH8073C
380mm/15"	44 mm	90,80	1	TAH8074C
460mm/18"	53 mm	129,88	1	TAH8075C

Chave Podger com manilha em D de segurança



TAH84



L	W	€	Box	Key
405mm/16"	41 mm	52,46	1	TAH84-PODGER

Chave boca luneta com mola de segurança



TAH111M



L	W	€	Box	Key
6 mm	112 mm	14,18	1	TAH111M-6
7 mm	120 mm	14,21	1	TAH111M-7
8 mm	130 mm	14,24	1	TAH111M-8
9 mm	136 mm	14,29	1	TAH111M-9
10 mm	144 mm	14,33	1	TAH111M-10
11 mm	153 mm	14,56	1	TAH111M-11
12 mm	160 mm	14,97	1	TAH111M-12
13 mm	165 mm	15,00	1	TAH111M-13
14 mm	177 mm	15,05	1	TAH111M-14
15 mm	185 mm	15,56	1	TAH111M-15
16 mm	195 mm	15,85	1	TAH111M-16
17 mm	200 mm	16,97	1	TAH111M-17
18 mm	208 mm	18,80	1	TAH111M-18
19 mm	215 mm	19,61	1	TAH111M-19
20 mm	240 mm	20,17	1	TAH111M-20
21 mm	250 mm	21,82	1	TAH111M-21
22 mm	250 mm	21,99	1	TAH111M-22
23 mm	270 mm	23,29	1	TAH111M-23
24 mm	270 mm	24,37	1	TAH111M-24
25 mm	290 mm	27,37	1	TAH111M-25
27 mm	310 mm	34,47	1	TAH111M-27
30 mm	330 mm	42,00	1	TAH111M-30
32 mm	345 mm	45,29	1	TAH111M-32
34 mm	347 mm	52,42	1	TAH111M-34
36 mm	400 mm	74,07	1	TAH111M-36
41 mm	438 mm	94,06	1	TAH111M-41
46 mm	500 mm	123,99	1	TAH111M-46
50 mm	540 mm	140,46	1	TAH111M-50
55 mm	560 mm	228,79	1	TAH111M-55

Chave boca luneta, pol., equip. c/mola de segurança



TAH111Z



L	W	€	Box	Key
1/4 in	112 mm	16,18	1	TAH111Z-1/4
5/16 in	130 mm	16,41	1	TAH111Z-5/16
3/8 in	140 mm	19,16	1	TAH111Z-3/8
7/16 in	153 mm	19,77	1	TAH111Z-7/16

L	W	€	Box	Key
1/2 in	169 mm	20,28	1	TAH111Z-1/2
9/16 in	177 mm	20,87	1	TAH111Z-9/16
5/8 in	195 mm	21,96	1	TAH111Z-5/8
11/16 in	200 mm	21,67	1	TAH111Z-11/16
3/4 in	218 mm	23,20	1	TAH111Z-3/4
13/16 in	250 mm	28,88	1	TAH111Z-13/16
7/8 in	250 mm	30,41	1	TAH111Z-7/8
15/16 in	270 mm	30,95	1	TAH111Z-15/16
1 in	290 mm	33,48	1	TAH111Z-1
1-1/16 in	310 mm	34,82	1	TAH111Z-1.1/16
1-1/8 in	310 mm	38,47	1	TAH111Z-1.1/8
1-1/4 in	350 mm	40,63	1	TAH111Z-1.1/4
1-5/16 in	350 mm	51,56	1	TAH111Z-1.5/16
1 3/8 in	410 mm	72,52	1	TAH111Z-1.3/8
1 7/16 in	410 mm	72,52	1	TAH111Z-1.7/16
1 1/2 in	410 mm	72,51	1	TAH111Z-1.1/2
1 5/8 in	460 mm	99,65	1	TAH111Z-1.5/8
1 11/16 in	460 mm	103,73	1	TAH111Z-1.11/16
1 3/4 in	500 mm	120,49	1	TAH111Z-1.3/4
1 13/16 in	500 mm	123,05	1	TAH111Z-1.13/16
1 7/8 in	540 mm	152,66	1	TAH111Z-1.7/8
2 in	540 mm	153,22	1	TAH111Z-2
2 1/4 in	600 mm	384,85	1	TAH111Z-2.1/4
2 3/8 in	600 mm	384,85	1	TAH111Z-2.3/8
2 5/8 in	680 mm	506,92	1	TAH111Z-2.5/8
2 3/4 in	680 mm	520,88	1	TAH111Z-2.3/4
2 7/8 in	730 mm	683,85	1	TAH111Z-2.7/8
3 in	730 mm	707,62	1	TAH111Z-3

Chave boca luneta com roquete c/mola de segurança. De acordo com as melhores práticas de DROPS



TAH1RM



L	W	€	Box	Key
6 mm	128 mm	28,94	1	TAH1RM-6
7 mm	140 mm	28,94	1	TAH1RM-7
8 mm	140 mm	29,07	1	TAH1RM-8
9 mm	150 mm	30,08	1	TAH1RM-9
10 mm	159 mm	30,18	1	TAH1RM-10
11 mm	165 mm	31,84	1	TAH1RM-11
12 mm	172 mm	32,72	1	TAH1RM-12
13 in	178 mm	31,87	1	TAH1RM-13
14 in	191 mm	36,17	1	TAH1RM-14
15 in	200 mm	37,17	1	TAH1RM-15
16 in	208 mm	38,05	1	TAH1RM-16
17 mm	226 mm	38,05	1	TAH1RM-17
18 in	237 mm	39,28	1	TAH1RM-18
19 mm	248 mm	41,04	1	TAH1RM-19
21 in	290 mm	50,80	1	TAH1RM-21
22 in	361 mm	49,16	1	TAH1RM-22
24 mm	323 mm	53,36	1	TAH1RM-24
27 in	359 mm	80,87	1	TAH1RM-27
30 mm	400 mm	95,53	1	TAH1RM-30
32 in	425 mm	106,00	1	TAH1RM-32



Chaves de extremidade de anel duplo de compensação longa, no sistema métrico, com acabamento cromado com mola deslizante de aço inoxidável



TAH2M



	L	€		
6x7 mm	165 mm	50,14	1	TAH2M-6-7
8x9 mm	180 mm	52,17	1	TAH2M-8-9
10x11 mm	190 mm	53,07	1	TAH2M-10-11
12x13 mm	210 mm	53,67	1	TAH2M-12-13
14x15 mm	226 mm	55,05	1	TAH2M-14-15
16x17 mm	246 mm	56,37	1	TAH2M-16-17
18x19 mm	266 mm	58,22	1	TAH2M-18-19

Chave de bocas duplas, métrica. C/ mola de segurança. De acordo com as melhores práticas de DROPS



TAH6M



	L	€		
6x7 mm	122 mm	13,75	1	TAH6M-6-7
8x9 mm	135 mm	14,35	1	TAH6M-8-9
10x11 mm	153 mm	16,74	1	TAH6M-10-11
12x13 mm	164 mm	17,16	1	TAH6M-12-13
14x15 mm	183 mm	17,41	1	TAH6M-14-15
16x17 mm	201 mm	17,76	1	TAH6M-16-17
17x19 mm	222 mm	20,45	1	TAH6M-17-19
18x19 mm	222 mm	20,55	1	TAH6M-18-19
20x22 mm	225 mm	25,08	1	TAH6M-20-22
24x27 mm	260 mm	43,91	1	TAH6M-24-27
30x32 mm	300 mm	50,90	1	TAH6M-30-32

Chave de porcas com mola de segurança



TAH1949M



	L	€		
8x9 mm	140 mm	29,80	1	TAH1949M-8-9
10x11 mm	150 mm	29,80	1	TAH1949M-10-11
12x14 mm	170 mm	33,39	1	TAH1949M-12-14
14x17 mm	200 mm	33,39	1	TAH1949M-14-17
19x22 mm	220 mm	45,66	1	TAH1949M-19-22
24x27 mm	255 mm	66,03	1	TAH1949M-24-27

Chave de luneta de impacto com manilha curva



TAH7444SG



	L	€		
36 mm	205 mm	66,62	1	TAH7444SG-M-36
41 mm	230 mm	85,04	1	TAH7444SG-M-41
46 mm	240 mm	93,23	1	TAH7444SG-M-46
50 mm	255 mm	104,81	1	TAH7444SG-M-50
55 mm	270 mm	119,85	1	TAH7444SG-M-55

Chaves de caixa de cabeça dupla no sistema métrico com 6 x 6 pontos Dynamic-Drive™ com anel de aço inoxidável



TAH29



	€		
12 mm	80,24	1	TAH29M-12
6 mm	77,12	1	TAH29M-6
7 mm	78,37	1	TAH29M-7
8 mm	79,61	1	TAH29M-8
10 mm	79,61	1	TAH29M-10

	€		
9 mm	79,61	1	TAH29M-9
11 mm	80,24	1	TAH29M-11
13 mm	80,24	1	TAH29M-13
14 mm	80,24	1	TAH29M-14
15 mm	80,24	1	TAH29M-15
16 mm	80,24	1	TAH29M-16
17 mm	80,85	1	TAH29M-17
18 mm	80,85	1	TAH29M-18
19 mm	80,85	1	TAH29M-19
20 mm	80,85	1	TAH29M-20
21 mm	84,40	1	TAH29M-21
22 mm	84,40	1	TAH29M-22
23 mm	85,03	1	TAH29M-23
24 mm	89,61	1	TAH29M-24
25 mm	90,27	1	TAH29M-25
26 mm	95,17	1	TAH29M-26
27 mm	94,09	1	TAH29M-27
28 mm	97,63	1	TAH29M-28
29 mm	102,17	1	TAH29M-29
30 mm	104,86	1	TAH29M-30
32 mm	109,89	1	TAH29M-32

Chave de quadro elétrico equipada com fio Dyneema. adequada para trabalhos em altura



TAHMK5



L	€		
97x25 mm	44,40	1	TAHMK5

Chv roquete c/anel seg. p/13 a 22 e manilha D p/chv 27-30. Pronta para trabalhos em altura



TAHSC2RM



	L	€		
13-17 mm	280 mm	54,69	1	TAHSC2RM-13-17
15-17 mm	280 mm	66,69	1	TAHSC2RM-15-17
19-22 mm	310 mm	73,37	1	TAHSC2RM-19-22
27-30 mm	450 mm	120,05	1	TAHSC2RM-27-30

CHAVES DE BOCAS PARA TUBOS

Chave tubos modelo sueco equipada c/ anel metálico.. Pronta para trabalhos em altura



ergo



TAH1410-TAH1420



mm	in	€	1	TAH1410
320 mm	1 in	88,03	1	TAH1410
430 mm	1 1/2 in	97,38	1	TAH1420

Chave tubos modelo sueco, 90° equip. c/ manilha curva. Pronta para trabalhos em altura



TAH14

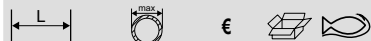

mm	in	€	1	TAH14
210 mm	3/4 in	72,04	1	TAH140
320 mm	1 in	78,53	1	TAH141
426 mm	1 1/2 in	102,87	1	TAH142
557 mm	2-1/2 in	146,74	1	TAH143

Chave de tubos de alumínio com ligação rápida



TAH380



mm	in	€	1	TAH380
253 mm	1.1/2 in	71,14	1	TAH380-10
354 mm	2 in	94,57	1	TAH380-14
455 mm	2.1/2 in	135,06	1	TAH380-18
607 mm	3 in	200,36	1	TAH380-24

CHAVES DE CAIXA E ROQUETES

Chave de caixa de comprimento std 1/4" c/ solução de 4 pontos



TAH08

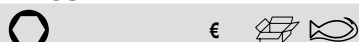

mm	€	1	TAH08
5.5 mm	6,47	1	TAH08-5.5
6 mm	6,47	1	TAH08-6
7 mm	6,47	1	TAH08-7
8 mm	6,47	1	TAH08-8
9 mm	6,47	1	TAH08-9
10 mm	6,47	1	TAH08-10
11 mm	6,47	1	TAH08-11
12 mm	6,47	1	TAH08-12
13 mm	6,47	1	TAH08-13

Barra de torção de 1/4" com mola de segurança



TAH6958B-1



mm	€	1	TAH6958B-1
150 mm	44,30	1	TAH6958B-1

Barra de extensão de 1/4" com 4 furos



TAH6960-TAH6962L



mm	€	1	TAH6960
50 mm	11,90	1	TAH6960
101 mm	12,91	1	TAH6961
152 mm	16,50	1	TAH6962
355 mm	37,64	1	TAH6962L

Cardan universal de 1/4" com 4 furos



TAH6966

mm	€	1	TAH6966
36 mm	29,80	1	TAH6966

Roquete quadrado 1/4", p/parafusos sext. c/solução 4 pontos



TAH08-H



mm	€	1	TAH08-H
3 mm	8,50	1	TAH08-H3
4 mm	8,50	1	TAH08-H4
5 mm	8,50	1	TAH08-H5
6 mm	8,50	1	TAH08-H6
8 mm	8,50	1	TAH08-H8

Roquete quadrado 1/4", p/parafusos Phillips c/solução 4 pts



TAH08-PH



mm	€	1	TAH08-PH
1	9,40	1	TAH08-PH1
2	9,40	1	TAH08-PH2
3	9,40	1	TAH08-PH3



Roquete quadrado 1/4", p/parafusos TORX® c/solução 4 pontos



TAH08TTAH



	€		
T-8	10,58	1	TAH08-T8
T-9	10,58	1	TAH08-T9
T-10	10,58	1	TAH08-T10
T-15	10,58	1	TAH08-T15
T-20	10,58	1	TAH08-T20
T-25	10,93	1	TAH08-T25
T-27	10,93	1	TAH08-T27
T-30	10,93	1	TAH08-T30
T-40	10,93	1	TAH08-T40

Roquete 1/4", 72 dentes/ângulo ação 5°, c/fio Dyneema selado



TAH6950



L	€		
120 mm	51,20	1	TAH6950

Extensão com cabo de 1/4" com uma bucha de segurança



TAH6956-1



L	€		
150 mm	15,15	1	TAH6956-1

Chave caixa comprimento std, encaixe quadrado 1/2" c/solução 4 pontos



TAH16B



	€		
8 mm	8,89	1	TAH16B-8
10 mm	8,21	1	TAH16B-10
11 mm	8,21	1	TAH16B-11
12 mm	8,70	1	TAH16B-12
13 mm	9,08	1	TAH16B-13
14 mm	9,53	1	TAH16B-14
15 mm	9,90	1	TAH16B-15
16 mm	10,09	1	TAH16B-16
17 mm	10,48	1	TAH16B-17
18 mm	10,48	1	TAH16B-18
19 mm	10,91	1	TAH16B-19
21 mm	11,50	1	TAH16B-21
22 mm	11,91	1	TAH16B-22
24 mm	13,43	1	TAH16B-24
25 mm	13,63	1	TAH16B-25
27 mm	14,32	1	TAH16B-27
30 mm	15,93	1	TAH16B-30
32 mm	16,25	1	TAH16B-32

Chave caixa compr. std, encaixe quadrado 1/2" c/solução 4 pts



TAH16B"



	€		
1/2 in	9,32	1	TAH16B-1/2
9/16 in	9,93	1	TAH16B-9/16
5/8 in	10,48	1	TAH16B-5/8
11/16 in	10,79	1	TAH16B-11/16
3/4 in	11,30	1	TAH16B-3/4
13/16 in	11,91	1	TAH16B-13/16
7/8 in	12,32	1	TAH16B-7/8
15/16 in	13,91	1	TAH16B-15/16
1 in	13,91	1	TAH16B-1
1 1/16 in	16,75	1	TAH16B-1.1/16
1 1/8 in	16,75	1	TAH16B-1.1/8
1 1/4 in	16,76	1	TAH16B-1.1/4

Barra de torção de 1/2" com mola de segurança



TAH8158B-1



L	€		
256 mm	106,88	1	TAH8158B-1

Barra de extensão de 1/2" com 4 furos



TAH8160-8162

L	€		
125 mm	81,85	1	TAH8160
250 mm	100,54	1	TAH8162

Cardan universal de 1/2" com solução de 4 pontos



TAH8166

L	€		
67 mm	41,56	1	TAH8166

Roquete quadrado 1/2", p/parafusos sext. c/solução 4 pontos



TAH16H

	€		
4 mm	16,37	1	TAH16-H4
5 mm	16,37	1	TAH16-H5
6 mm	16,37	1	TAH16-H6
7 mm	16,37	1	TAH16-H7
8 mm	17,73	1	TAH16-H8
10 mm	17,73	1	TAH16-H10
12 mm	18,15	1	TAH16-H12
14 mm	19,90	1	TAH16-H14
17 mm	19,08	1	TAH16-H17
19 mm	19,61	1	TAH16-H19

Roquete quadrado 1/2", p/parafusos sext. c/solução 4 pontos



TAH16H"

	€		
1/4 in	16,06	1	TAH16H-1/4
5/16 in	16,06	1	TAH16H-5/16
3/8 in	16,06	1	TAH16H-3/8
7/16 in	16,53	1	TAH16H-7/16
1/2 in	17,46	1	TAH16H-1/2
9/16 in	17,89	1	TAH16H-9/16
5/8 in	18,36	1	TAH16H-5/8

Roquete quadrado 1/2", p/parafusos TORX® c/solução 4 pontos



TAH16-T

	€		
T30	18,56	1	TAH16-T30
T40	21,67	1	TAH16-T40
T45	21,67	1	TAH16-T45



€

T50	21,67	1	TAH16-T50
T55	27,13	1	TAH16-T55
T60	27,13	1	TAH16-T60

Roquete reversível, 1/2" - 80 dentes/ ângulo ação 4,5°, c/fio Dyneema selado



TAH8150-1/2

	€		
270 mm	81,82	1	TAH8150-1/2

Conjunto de chaves de caixa quadradas de 1/2" com perfil sextavado métrico e roquete de cabeça de pera - 22 peças para trabalhar em altura



TAH16BM/22

	€		
85 x 350 x 445 mm	499,12	1	TAH16BM/22

Conjunto de chaves de caixa quadradas de 1/2" com perfil sextavado imperial e roquete de cabeça de pera - 17 peças para trabalhar em altura



TAH16BZ/17

	€		
80 x 300 x 380 mm	429,80	1	TAH16BZ/17

Chave caixa comprimento std, encaixe quadrado 3/4" c/solução 4 pontos



TAH24B

	€		
27 mm	25,19	1	TAH24B-27
30 mm	28,27	1	TAH24B-30
32 mm	29,44	1	TAH24B-32
36 mm	34,03	1	TAH24B-36
38 mm	36,24	1	TAH24B-38
41 mm	39,93	1	TAH24B-41
46 mm	47,12	1	TAH24B-46
50 mm	53,24	1	TAH24B-50

Barra de extensão de 3/4" com 4 pontos



TAH8961

	€		
200 mm	49,21	1	TAH8961

Cabo universal de 3/4" com anel metálico



TAH8953

	€		
500 mm	56,08	1	TAH8953



Cabeça de roquete de 3/4", reversível com um anel metálico



TAH8950N/A

	€		
170 mm	203,81	1	TAH8950N/A

Chave de parafusos de fenda ERGO™ com um fio Dyneema



ergo



TAHBE8155

		€		
6 mm	125 mm	29,96	1	TAHBE-8155
8 mm	175 mm	35,14	1	TAHBE-8257
10 mm	210 mm	37,50	1	TAHBE-8258

Chave parafusos ERGO™ p/parafusos Phillips c/bucha segurança



ergo



TAHBE8610-TAHBE8624

		€		
PH 1	75 mm	23,84	1	TAHBE-8611
PH 1	75 mm	23,71	1	TAHBE-8610
PH 2	100 mm	27,56	1	TAHBE-8620
PH 2	200 mm	31,04	1	TAHBE-8620L
PH 3	150 mm	35,00	1	TAHBE-8623
PH 4	190 mm	39,99	1	TAHBE-8624

Extrator de pinos para chaves TAH



ergo



TAHPINRELEASER

		€		
4 mm	45 mm	47,98	1	TAHPINRELEASER

Chave parafusos ERGO™ p/parafusos de fenda com fio Dyneema



ergo



TAHBE-8260

		€		
9 mm	175 mm	40,78	1	TAHBE-8260
12 mm	200 mm	53,59	1	TAHBE-8880

Chave parafusos ERGO™ p/parafusos Phillips, com fio Dyneema



ergo



TAHBE-8630

		€		
PH 3	155 mm	42,62	1	TAHBE-8630

CHAVES DE PARAFUSOS

Chave de parafusos de fenda ERGO™ com uma bucha de segurança



ergo



TAHBE8020L-TAHBE8252

		€		
3.2 mm	75 mm	19,26	1	TAHBE-8020L
3.5 mm	75 mm	19,79	1	TAHBE-8030
4 mm	100 mm	20,68	1	TAHBE-8040
5.5 mm	150 mm	24,19	1	TAHBE-8241
6.5 mm	150 mm	28,34	1	TAHBE-8252

Chave parafusos tipo coto ERGO™ p/parafusos fenda c/bucha segurança



ergo



TAHBE-8350

		€		
5.5 mm	28 mm	21,71	1	TAHBE-8350

Chave parafusos tipo coto ERGO™ p/parafusos Phillips c/bucha segurança



ergo



TAHBE-8602

		€		
PH2	30 mm	24,02	1	TAHBE-8602

Chave parafusos ERGO™ p/parafusos Pozidriv c/bucha segurança



ergo



TAHBE8810-TAHBE8820



Bit	Length	Price	Qty	Model
PZ 1	73 mm	25,29	1	TAHBE-8810
PZ 2	100 mm	29,00	1	TAHBE-8820

Chave de parafusos de fenda ERGO™ isolada com fio de Kevlar



ergo



TAHBE8040S-TAHBE8050S



Bit	Length	Price	Qty	Model
3.0 mm	100 mm	10,85	1	TAHBE-8220S
4.0 mm	100 mm	13,16	1	TAHBE-8040S
5.5 mm	125 mm	15,70	1	TAHBE-8050S
6.5 mm	155 mm	20,08	1	TAHBE-8255S

Chaves de parafusos Pozidriv finas com isolamento VDE ERGO™ com pega de 3 componentes e fio Kevlar



ergo



TAHBE-8820SL



PZ 2	PZ 2	21,69	1	TAHBE-8820SL
------	------	-------	---	--------------

Chave parafusos ERGO™ p/parafusos Pozidriv, com fio Dyneema



ergo



TAHBE-8830



Bit	Length	Price	Qty	Model
PZ 3	150 mm	42,62	1	TAHBE-8830

Chave de parafusos Phillips ERGO™ isolada com fio de Kevlar



ergo



TAHBE8610S-TAHBE8620S



Bit	Length	Price	Qty	Model
PH1	80 mm	13,96	1	TAHBE-8610S
PH2	100 mm	18,02	1	TAHBE-8620S
PH3	150 mm	23,09	1	TAHBE-8630S
PH4	190 mm	34,18	1	TAHBE-8640S

Chaves de fenda com pega de precisão 0,18-0,8 mm com anel de aço inoxidável



TAH700



Bit	Length	Price	Qty	Model
1.5 mm	137 mm	54,44	1	TAH700-1.5-50
1.8 mm	137 mm	54,44	1	TAH700-1.8-50
2.5 mm	137 mm	54,92	1	TAH700-2.5-50
3 mm	187 mm	54,92	1	TAH700-3-100

Chave parafusos ERGO™ equip. c/ mandril de segurança. Para parafusos com cabeça TORX®



ergo



TAHBE8910-TAHBE8930



Bit	Length	Price	Qty	Model
T10	2.72 mm	27,11	1	TAHBE-8910
T15	3.26 mm	28,01	1	TAHBE-8915S
T20	3.84 mm	29,34	1	TAHBE-8920
T25	4 mm	30,68	1	TAHBE-8925S
T30	6 mm	32,02	1	TAHBE-8930

Chave parafusos ERGO™ TORX® isolada, equip. c/ fio Kevlar. Pronta para trabalhos em altura



ergo



TAHBE8910S-TAHBE8930S



Bit	Length	Price	Qty	Model
T10	2.5 mm	20,01	1	TAHBE-8910S
T15	3.26 mm	25,34	1	TAHBE-8915S
T20	3.84 mm	30,02	1	TAHBE-8920S
T25	4.4 mm	32,02	1	TAHBE-8925S
T30	5.49 mm	33,35	1	TAHBE-8930S

Chaves de parafusos Phillips com pega de precisão PH00-PH1 com anel de aço inoxidável



TAH701



PH00	137 mm	54,49	1	TAH701-00-50
PH 0	137 mm	54,49	1	TAH701-0-50



Chaves de parafusos TORX® com pega de precisão T4-T20 com anel de aço inoxidável



TAH703

Icon	Length	Price (€)	Quantity	Model
T 6	137 mm	54,63	1	TAH703-6-50
T 7	137 mm	54,63	1	TAH703-7-50
T 8	137 mm	54,63	1	TAH703-8-50
T 9	137 mm	54,68	1	TAH703-9-50
T 10	137 mm	54,60	1	TAH703-10-50
T 15	162 mm	54,81	1	TAH703-15-75

Chaves em L sextavadas, no sistema métrico, com acabamento fosfatado com anel de aço inoxidável



TAH1995M

Icon	Length	Price (€)	Quantity	Model
8 mm	108 mm	24,28	1	TAH1995M-8
10 mm	122 mm	25,07	1	TAH1995M-10
12 mm	137 mm	26,33	1	TAH1995M-12

Chaves em L sextavadas, no sistema imperial, com acabamento fosfatado com anel de aço inoxidável



TAH1995Z

Icon	Length	Price (€)	Quantity	Model
1/2 in	145 mm	27,97	1	TAH1995Z-1/2

Conjunto de chaves em L dobráveis e sextavadas no sistema métrico com acabamento fosfatado 1,5 mm-6 mm - 7 peças com aro de arame têxtil Kevlar



TAHBE-9776

Icon	Lengths	Price (€)	Quantity	Model
X	7 1.5 2.5 3 4 5 6 mm	48,43	1	TAHBE-9776

Conj. chaves parafusos offset sext. 7 pçs, métrico, com fio de Kevlar



TAHBE-9777B

Icon	Lengths	Price (€)	Quantity	Model
X	2.5,3,4,5,6,8,10 mm	39,76	1	TAHBE-9777B

Conj. chaves parafusos offset sext. 7 pçs, pol. com placa encaixável



TAHBE-9787

Icon	Lengths	Price (€)	Quantity	Model
X	3/32, 1/8, 5/32, 3/16, 1/4, 5/16, 3/8 in	42,57	1	TAHBE-9787

Chave offset dupla para parafusos de fenda com arame de aço



TAH2047

Icon	Length	Price (€)	Quantity	Model
X	4.0 mm 100 mm	27,97	1	TAH2047-0.8-4

Chave offset dupla para parafusos Phillips com arame de aço



TAH2047PR

Icon	Length	Price (€)	Quantity	Model
X	PH 1 & 2 100 mm	31,48	1	TAH2047PR-1-2

ALICATES

Alicate de corte lateral com anel de segurança



ergo



TAH2101G

Icon	Length	Price (€)	Quantity	Model
X	130 mm	57,36	1	TAH2101G-125
X	145 mm	52,70	1	TAH2101G-140
X	165 mm	61,06	1	TAH2101G-160
X	185 mm	62,69	1	TAH2101G-180
X	125 mm	57,36	1	TAH2101G-125C
X	145 mm	60,30	1	TAH2101G-140C
X	165 mm	61,06	1	TAH2101G-160C
X	180 mm	62,69	1	TAH2101G-180C

Alicate corte lateral p/trab. pesado equip. c/anel segur. Pronto para trabalhos em altura



ergo®



TAH21HDG



L	€	Box	Icon
210 mm	64,02	1	TAH21HDG-200
200 mm	64,02	1	TAH21HDG-200C

Alicate de pontas com anel de segurança



ergo®



TAH2430G



L	€	Box	Icon
160 mm	43,10	1	TAH2430G-160
200 mm	43,61	1	TAH2430G-200

Alicate de cravar e roquete para conectores isolados com laço de arame metálico fixo



TAHCRW01

L	€	Box	Icon
225 mm	151,03	1	TAHCRW01

Alicate universal com um anel de segurança



ergo®



TAH2628G



L	€	Box	Icon
170 mm	56,75	1	TAH2628G-160
190 mm	58,49	1	TAH2628G-180
200 mm	74,65	1	TAH2628G-200

Alicate de pontas dobradas a 45° com anel de segurança



ergo®



TAH2427G



L	€	Box	Icon
200 mm	44,77	1	TAH2427G-200

Alicate para anéis de retenção internos com mandíbulas retas e acabamento fosfatado com anel de aço inoxidável



TAH2800



L	€	Box	Icon
150 mm	44,81	1	TAH2800-150
180 mm	75,54	1	TAH2800-180

Alicate 2 posições equipado com anel de segurança. Pronto para trabalhos em altura



TAH2970G



L	€	Box	Icon
200 mm	59,47	1	TAH2970G-200

Alicate de descarnar adequado para trabalhos em altura. Alicate de descarnar adequado para trabalhos em altura



ergo®



TAH2223G-150



L	€	Box	Icon
167 mm	56,58	1	TAH2223G-150

Alicate para anéis de retenção externos com mandíbulas retas e acabamento fosfatado com anel de aço inoxidável



TAH2900



L	€	Box	Icon
180 mm	76,17	1	TAH2900-180



Pega universal TAH com cabeça curvada



TAH2951



	€		
235 m	62,05	1	TAH2951-250

Alicate de bomba de água com um anel de segurança



ergo



TAH8224



	€		
250 mm	73,52	1	TAH8224

FERRAMENTAS DE CORTE

Serrote de poda dobráveis com cabo de dois componentes com cordão de Dyneema selado



TAH396



		€		
190 mm	7 1/2 in	58,37	1	TAH396-JT

Alicate de pressão automático com mandíbulas curvadas com placa metálica fixa



TAH2953



	€		
140 mm	57,40	1	TAH2953-140
300 mm	73,02	1	TAH2953-300

Alicate de corte frontal de Alta Alavancagem com Anel de Segurança



TAH2339



		€		
2.5 mm	250 mm	39,66	1	TAH2339-250

Armação de serrote profissional com um anel metálico



ergo



TAH325



	€		
300 mm	73,07	1	TAH325

Alicate de pressão com maxilas retas com placa encaixável



TAH2958



	€		
200 mm	45,94	1	TAH2958-200
245 mm	49,64	1	TAH2958-250

Alicate torcedor com anel de segurança



TAH2855



	€		
232 mm	205,05	1	TAH2855

Armação de serrote tradicional com um anel metálico



TAH320



	€		
500 mm	28,80	1	TAH320

Armação de serrote para utilização geral com anel metálico



TAH317

	€		
432 mm	39,28	1	TAH317

Armação de serrote em alumínio com um anel metálico



TAH225

	€		
310 mm	53,76	1	TAH225-PLUS

Lima paralela com um anel de segurança



ergo®



TAH1-100

		€		
265 mm	2	19,95	1	TAH1-100-06-2-4

Lima plana de extremidade afunilada de engenharia ERGO™ para corte bastardo, segundo corte ou murça com anel permanente em aço inoxidável



ergo®



TAH1-110

		€		
200 mm	1	22,08	1	TAH1-110-08-1-2

Lima para oficina c/2 cantos paralelos com anel de segurança



ergo®



TAH1-143

		€		
415 mm	1	25,53	1	TAH1-143-12-1-2

Lima quadrada de engenharia ERGO™ para corte bastardo, segundo corte ou murça com anel permanente em aço inoxidável



ergo®



TAH1-160

		€		
200 mm	1	19,80	1	TAH1-160-08-1-2

Lima triangular de engenharia ERGO™ para corte bastardo, segundo corte ou murça com anel permanente em aço inoxidável



ergo®



TAH1-170

		€		
200 mm	1	20,66	1	TAH1-170-08-1-2

Lima meia-cana com um anel de segurança



ergo®



TAH1-210

		€		
270 mm	2	23,01	1	TAH1-210-06-2-2
325 mm	1	24,41	1	TAH1-210-08-1-2

Lima redonda com bucha de segurança



ergo®



TAH1-230

		€		
260 mm	2	12,57	1	TAH1-230-06-2-2
310 mm	1	25,84	1	TAH1-230-08-1-2

Tesoura de electricista resistente com anel metálico



TAHSCB140G

		€		
145 mm	43 mm	41,68	1	TAHSCB140G

Faca de electricista com fio Dyneema



TAH2820EF

		€		
195 mm	85 mm	27,56	1	TAH2820EF2



Escova de aço universal. Pronta para trabalhos em altura



TAH52-TAH782-U



L	€	Icon 1	Icon 2
150 mm	24,68	1	TAH52
290 mm	23,61	1	TAH782-U

Martelo de bola com anel metálico



TAH479



L	€	Icon 1	Icon 2
480 g	350 mm	62,93	1 TAH479-16
900 g	400 mm	68,89	1 TAH479-32

Marreta de segurança com anel metálico



TAH489



L	€	Icon 1	Icon 2
1100 g	294 mm	204,94	1 TAH489-1100
1800 g	300 mm	219,51	1 TAH489-1800
2700 g	770 mm	228,59	1 TAH489-2700
3600 g	770 mm	252,12	1 TAH489-3600
4500 g	797 mm	352,14	1 TAH489-4500
5400 g	795 mm	297,56	1 TAH489-5400

MARTELOS, PÉS DE CABRA E FORMÕES

Marreta antirricochete com anel metálico



TAH3625PU



L	€	Icon 1	Icon 2
620 g	340 mm	62,53	1 TAH3625PU-50

Martelo DIN tipo alemão com anel metálico



TAH481



L	€	Icon 1	Icon 2
300 g	300 mm	49,86	1 TAH481-300

Martelos de bola com cabo inquebrável e laço de arame metálico fixo



TAH490



L	€	Icon 1	Icon 2
700 g	340 mm	131,77	1 TAH490-700
900 g	340 mm	137,92	1 TAH490-900
1100 g	340 mm	162,21	1 TAH490-1100

Maço com cabeça de nylon com anel metálico



TAH3625PW



L	€	Icon 1	Icon 2
300 mm	52,89	1	TAH3625W-35

Marreta com anel metálico



TAH484



L	€	Icon 1	Icon 2
1000 g	260 mm	62,24	1 TAH484-1000
1500 g	280 mm	60,26	1 TAH484-1500
2000 g	305 mm	63,20	1 TAH484-2000

Martelo de pedreiro tipo espanhol c/anel metálico. De acordo com as melhores práticas de DROPS



TAH486F



L	€	Icon 1	Icon 2
700 g	330 mm	31,89	1 TAH486F-700

Garra de martelo de carpinteiro com haste tubular de aço com aro de arame



TAH485



		€		
600 g	318 mm	60,67	1	TAH485

Punção paralelo em dois materiais com bucha de segurança



TAH3734BM



		€		
155 mm	2 mm	29,95	1	TAH3734BM-2
155 mm	3 mm	29,95	1	TAH3734BM-3
165 mm	4 mm	30,41	1	TAH3734BM-4
165 mm	5 mm	30,41	1	TAH3734BM-5
185 mm	6 mm	31,26	1	TAH3734BM-6
185 mm	8 mm	31,48	1	TAH3734BM-8
185 mm	10 mm	23,37	1	TAH3734BM-10

Ponteiros com haste octogonal e acabamento em cobre envernizado com aro de arame metálico fixo



TAH3739



	€		
300 mm	34,15	1	TAH3739-300

Martelo antichispa e antimagnético c/ manilha bronze-alumínio



TAH487



		€		
4500 g	895 mm	594,59	1	TAH487-5200

Punção de centro em dois materiais com bucha de segurança



TAH3755BM



		€		
165 mm	4 mm	16,54	1	TAH3755BM-4

Alavanca com anel de segurança



TAH2484



	€		
305 mm	15,42	1	TAH2484-30

Pé de cabra sextavado de aço especial TAH



TAHWBB



	€		
595 mm	39,14	1	TAHWBB600
680 mm	41,68	1	TAHWBB700

Formão com anel de segurança



TAH3640



	€		
250 mm	33,89	1	TAH3640-250-C

Alavanca especial de 90°, equipada c/ manilha curva. Pronta para trabalhos em altura



TAH3683



	€		
400 mm	43,43	1	TAH3683



Pé de cabra com cabeça rotativa com corpo fosfatado e laço de arame metálico fixo



TAH3681



L	€		
304 mm	71,49	1	TAH3681-11
406 mm	79,03	1	TAH3681-16
503 mm	97,15	1	TAH3681-20

Nível torpedo com um fio Dyneema



TAH466



L	€		
250 mm	44,42	1	TAH466-250

Esquadro equipado com fio Dyneema para trabalhos em altura. Acabamento em preto



TAH9045-B-250



L	€		
250 mm	37,07	1	TAH9045-B-250

MEDIÇÃO E ORGANIZAÇÃO

Fitas métricas longas com lâmina revestida a nylon e mala aberta com laço de arame têxtil Dyneema



TAHLTS

L	€		
30 m	81,60	1	TAHLTS-30

Esquadro combinado equipado com fio Dyneema. adequado para trabalhos em altura



TAHCS300

L	€		
300 mm	37,07	1	TAHCS300

Paquímetro com anel de segurança



TAH1150



L	€		
7 x 75 x 235 mm	131,37	1	TAH1150-1/2H/P

Réguas métricas de aço inoxidável com laço de arame têxtil Dyneema



TAHSR300



L	€		
300 mm	51,17	1	TAHSR300-MM

Esquadro equipado com fio Dyneema. adequado para trabalhos em altura



TAH9048-250



L	€		
250 mm	38,23	1	TAH9048-250

Riscador offset com anel metálico



TAH1177



g	€		
30 g	24,29	1	TAH1177-SCRIBE

Calibre de lâminas profissional com anel de segurança



TAH1544



	€		
105 mm	20,55	1	TAH1544

FERRAMENTAS DINAMOMÉTRICAS

Chave dinamométrica de clique ajustável mecânica com escala marcada e cabeça de roquete fixa com placa metálica



TAH73R



	€		
1/2"	20-100 N·m	442,36	1 TAH73R-100
1/2"	40-200 N·m	457,11	1 TAH73R-200
1/2"	60-300 N·m	473,96	1 TAH73R-300

Chave din. c/escala e cabo plástico, equip. c/anel metálico. Pronta para trabalhos em altura - pino de segurança



TAH7445



	€		
20-100 N·m	1/2 in	326,82	1 TAH7445-100A-1

Chave dinamométrica com anel metálico



TAH7455



	€		
60-300 N·m 44.3-221.3 lbf·ft	397,31	1	TAH7455-300-1

Chaves torques com cabeça intercambiável e laço de arame



TAH74W9



	€		
20-100 N·m 9x12 mm	260,51	1	TAH74W9-100

Cabeça de roquete reversível com dispositivo de fecho



TAH7452-2



	€		
9x12 mm	1/2"	120,65	1 TAH7452-2

Ferramentas de inserção de roquete reversível com mecanismo de bloqueio de pinos de segurança



TAH7852-1



	€		
14X18 mm	1/2"	96,31	1 TAH7852-1

GRAMPOS

Grampo equipado com manilha em D. adequado para trabalhos em altura



TAH420SH-80-160



	€		
160 mm	80 mm	44,82	1 TAH420SH-80-160

OUTRAS FERRAMENTAS

Raspador de carbono com mola de segurança



TAH2487



	€		
205 mm		21,45	1 TAH2487



Conjunto de ferramentas miniatura com sovelas/ganchos/ponteiros com laço de arame t xtil Kevlar



TAH2633

	€		
146 g	122,64	1	TAH2633/S4

Chave de corrente para filtro de  leo com manilha em D



TAHBE64520

		€		
520 mm	60-160 mm	96,33	1	TAHBE64520

LUVAS

Luva de uso geral



GL008

	€		
8	19,67	5	GL008-8
10	19,67	5	GL008-10

Ferramenta de captura flex vel com anel met lico



TAH2509

	€		
560 mm	94,11	1	TAH2509

Lanterna de cabe a



TAHBFRL11

	€		
90 x 95 x 115 mm	77,61	1	TAHBFRL11

Luva universal



3875-GLOVE

		€		
9	67 g	15,87	5	3875-GLOVE

Pick-up magn tico com fio Dyneema



ergo



TAH2535F2

		€		
13 mm	405 mm	51,18	1	TAH2535F2

Bomba de lubrificante equipada com liga o r pida. Pronta para trabalhos em altura



TAHBOD54

	€		
120 x 385 x 57 mm	51,41	1	TAHBOD5400
135 x 400 x 61 mm	70,94	1	TAHBOD5450

Luva para ferramentas pneum ticas



GL010

	€		
8	24,98	5	GL010-8
10	24,98	5	GL010-10



Ferramentas isoladas



CHAVES DE PARAFUSOS

Chave Parafusos Isolada 1000V. Série ERGO™ Fenda



ergo



BE-8010S - BE-8065S

Tip	Length	Price (€)	Qty	Model
2.5 mm	75 mm	7,65	5	BE-8010S
3.0 mm	100 mm	7,65	5	BE-8220S
3.5 mm	100 mm	7,98	5	BE-8230S
4.0 mm	100 mm	9,28	5	BE-8040S
5.5 mm	125 mm	11,08	5	BE-8050S
6.5 mm	150 mm	14,17	5	BE-8255S
8.0 mm	175 mm	15,65	5	BE-8065S
10 mm	200 mm	20,46	5	BE-8258S
12 mm	200 mm	23,78	5	BE-8259S

Série ERGO™ Fenda

Chave de Parafusos Isolada 1000V. Série ERGO™ Phillips®



ergo



BE-8600S - BE-8640S

Tip	Length	Price (€)	Qty	Model
PH 0	75 mm	7,97	5	BE-8600S
PH 1	80 mm	9,86	5	BE-8610S
PH1	80 mm	9,84	5	BE-8611S
PH 1	150 mm	11,24	5	BE-8612S
PH 2	100 mm	12,70	5	BE-8620S
PH 2	100 mm	15,41	5	BE-8621S
PH 2	175 mm	15,45	5	BE-8622S
PH 3	150 mm	16,29	5	BE-8630S
PH 4	200 mm	24,11	5	BE-8640S

Série ERGO™ Phillips®

Chave parafusos isolada 1000V. Série ERGO™ Pozidriv®



ergo



BE-8800S - BE-8840S

Tip	Length	Price (€)	Qty	Model
PZ 0	75 mm	8,85	5	BE-8800S
PZ 1	80 mm	10,58	5	BE-8810S
PZ1	80 mm	10,58	5	BE-8811S
PZ 1	150 mm	12,53	5	BE-8812S
PZ 2	100 mm	13,20	5	BE-8820S
PZ 2	100 mm	13,69	5	BE-8821S
PZ 2	175 mm	15,50	5	BE-8822S
PZ 3	150 mm	19,87	5	BE-8830S
PZ 4	200 mm	22,81	5	BE-8840S

Série ERGO™ Pozidriv®

Chave Parafusos Isolada 1000V. Série ERGO™ Torx®



ergo



BE-8910S - BE-8930S

Tip	Length	Price (€)	Qty	Model
T 5	75 mm	8,00	5	BE-8905S
T 6	75 mm	8,00	5	BE-8906S
T 7	75 mm	8,00	5	BE-8907S
T 8	75 mm	8,00	5	BE-8908S
T 9	75 mm	8,00	5	BE-8909S
T 10	100 mm	8,26	5	BE-8910S
T 15	125 mm	8,32	5	BE-8915S
T 20	125 mm	8,47	5	BE-8920S
T 25	150 mm	8,78	5	BE-8925S
T 30	175 mm	11,34	5	BE-8930S

Série ERGO™ Torx®

Chave Parafusos isolada 1000V. Série ERGO™ Hexagonal



ergo



BE-8725S - BE-8708S

Tip	Length	Price (€)	Qty	Model
2.5 mm	100 mm	6,30	5	BE-8725S
3 mm	125 mm	6,57	5	BE-8703S
4 mm	150 mm	7,99	5	BE-8704S
5 mm	175 mm	9,04	5	BE-8705S
6 mm	150 mm	9,51	5	BE-8706S
8 mm	200 mm	12,80	5	BE-8708S

Série ERGO™ Hexagonal

Chaves de parafusos ERGO™ isoladas, pontas combinadas. fenda 5&6 e Phillips 1&2



ergo



BE-8510S - BE-8520S

Tip	Length	Price (€)	Qty	Model
5.0/PH1	80 mm	9,80	5	BE-8510S
6.0/PH2	100 mm	13,35	5	BE-8520S

fenda 5&6 e Phillips 1&2

Chaves de parafusos ERGO™ isoladas, pontas combinadas. fenda 5&6 e Pozidriv 1&2



ergo



BE-8710S - BE-8720S

Tip	Length	Price (€)	Qty	Model
5.0/PZ1	80 mm	10,67	5	BE-8710S
6.0/PZ2	100 mm	14,43	5	BE-8720S

fenda 5&6 e Pozidriv 1&2

Chave ERGO™ isolada hexagonal para porcas



ergo



BE-7855S - BE-7810S

Tip	Length	Price (€)	Qty	Model
5.5 mm	125 mm	14,54	5	BE-7855S
6 mm	125 mm	15,97	5	BE-7806S
7 mm	125 mm	17,12	5	BE-7807S
8 mm	125 mm	18,90	5	BE-7808S
9 mm	125 mm	21,02	5	BE-7809S
10 mm	125 mm	23,25	5	BE-7810S

Conjunto de 2 chaves ERGO™ isoladas, para uso em quadros elétricos e terminais Para parafusos de Fenda e Pozidriv. Para kombi spor/Pozidriv skruer



ergo



BE-9890S

X	g	€		
2	175 g	24,13	1	BE-9890S

Para kombi spor/Pozidriv skruer

BE-8710S, BE-8720S	
--------------------	--

Jogo Chaves de Parafusos Isoladas 1000V. Série ERGO™ Fenda & PH



ergo



BE-9881S

X	€		
5	44,18	1	BE-9881S

Série ERGO™ Fenda & PH

BE-8220S, BE-8040S, BE-8050S	
BE-8611S, BE-8621S	

Jogo chaves de Parafusos Isoladas 1000V. Série ERGO™ Fenda & PZ



ergo



BE-9882S

X	€		
5	45,58	1	BE-9882S

Série ERGO™ Fenda & PZ

BE-8220S, BE-8050S, BE-8040S	
BE-8811S, BE-8821S	

Chaves de parafusos ERGO™, pontas combinadas. fenda/PH e fenda/PZ



ergo



BE-9885S

X	€		
5	47,06	1	BE-9885S

fenda/PH e fenda/PZ

806-1-1	
BE-8520S, BE-8510S	
BE-8710S, BE-8720S	

Conjunto de 6 chaves ERGO™ isoladas Para parafusos de Fenda e Pozidriv. Para parafusos de fenda, Pozidriv e Combi



ergo



BE-9884S

X	€		
6	64,77	1	BE-9884S

Para parafusos de fenda, Pozidriv e Combi

BE-8220S, BE-8040S	
BE-8710S, BE-8720S	
BE-8810S, BE-8820S	

Jogo Chaves de Parafusos Isoladas 1000V. Série ERGO™ Fenda e Pozidriv



ergo



BE-9888S

X	€		
7	65,00	1	BE-9888S

Série ERGO™ Fenda e Pozidriv

BE-8040S, BE-8050S, BE-8010S, BE-8220S	
BE-8800S, BE-8821S, BE-8830S	

Conjunto de 7 chaves ERGO™ isoladas Para parafusos de Fenda e Phillips. Para parafusos de fenda e Phillips



ergo



BE-9887S

X	€		
7	60,22	1	BE-9887S

Para parafusos de fenda e Phillips

806-1-1	
BE-8010S, BE-8050S, BE-8230S, BE-8040S	
BE-8611S, BE-8621S	

Conjunto de 7 chaves ERGO™ isoladas Para parafusos de Fenda e Pozidriv. Para parafusos de fenda e Pozidriv



ergo



BE-9889S

X	€		
7	55,37	1	BE-9889S

Para parafusos de fenda e Pozidriv

BE-8010S, BE-8040S, BE-8050S, BE-8230S	
BE-8821S, BE-8811S	
806-1-1	



Conjunto de chaves de parafusos isoladas ERGO™, 14 peças



ergo



BE-9876S

	€		
14	113,74	1	BE-9876S

- BE-8010S, BE-8220S, BE-8230S, BE-8040S, BE-8050S
- BE-8611S, BE-8621S
- BE-8811S, BE-8821S
- BE-8910S, BE-8915S, BE-8920S
- BE-8710S, BE-8720S

Chaves de fendas isoladas ERGO™ com lâminas SLIM. Para parafusos de fenda



ergo



BE-8220SL - BE-8255SL

		€		
3.0 mm	100 mm	8,43	10	BE-8220SL
3.5 mm	100 mm	8,78	10	BE-8230SL
4.0 mm	100 mm	10,21	10	BE-8040SL
5.5 mm	125 mm	12,19	10	BE-8050SL
6.5 mm	150 mm	15,60	10	BE-8255SL

Para parafusos de fenda

Chaves de parafusos isoladas ERGO™ Phillips com lâminas SLIM. Para parafusos Phillips



ergo



BE-8610SL - BE-8620SL

		€		
PH 1	80 mm	10,84	10	BE-8610SL
PH 2	100 mm	13,99	10	BE-8620SL

Para parafusos Phillips

Chaves de parafusos isoladas ERGO™ Pozidriv com lâminas SLIM. Para parafusos Pozidriv



ergo



BE-8810SL - BE-8820SL

		€		
PZ 1	80 mm	11,65	10	BE-8810SL
PZ 2	100 mm	14,51	10	BE-8820SL

Para parafusos Pozidriv

Chaves de parafusos isoladas ERGO™ TORX® com lâminas SLIM. Para parafusos TORX®



ergo



BE-8910SL - BE-8930SL

		€		
T 10	100 mm	9,08	5	BE-8910SL
T 15	100 mm	9,16	5	BE-8915SL
T 20	100 mm	9,32	5	BE-8920SL
T 25	125 mm	9,66	5	BE-8925SL
T 30	150 mm	12,49	5	BE-8930SL

Para parafusos TORX®

Chaves de parafusos isoladas ERGO™ de ponta Combi com lâminas SLIM. Para parafusos de fenda Combi/ Phillips



ergo



BE-8510SL - BE-8520SL

		€		
5.0/PH1	80 mm	10,78	10	BE-8510SL
6.0/PH2	100 mm	14,69	10	BE-8520SL

Para parafusos de fenda Combi/ Phillips

Chaves de parafusos isoladas ERGO™ de ponta Combi com lâminas SLIM. Para parafusos de fenda Combi/ Pozidriv



ergo



BE-8710SL - BE-8720SL

		€		
5.0/PZ1	80 mm	11,74	10	BE-8710SL
6.0/PZ2	100 mm	15,88	10	BE-8720SL

Para parafusos de fenda Combi/ Pozidriv

Conj. chaves parafusos estreitas isoladas ERGO™, 2 pçs, p/ quadros elétricos e terminais



ergo



BE-9890SL

		€		
2	175 g	26,56	1	BE-9890SL

BE-8710SL, BE-8720SL

Conj. chaves de parafusos isoladas ERGO™ estreitas, 2 peças



ergo



BE-9891SL

		€		
2	132 g	23,87	1	BE-9891SL

BE-8610SL, BE-8620SL

Conj. chaves de parafusos isoladas ERGO™ estreitas, 2 peças



ergo



BE-9894SL

X	g	€		
2	132 g	25,16	1	BE-9894SL

BE-8810SL, BE-8820SL

Conj. chave parafusos isoladas ERGO™, c/lâminas SLIM, 4 pçs. Para parafusos com cabeça TORX®



ergo



BE-9880SL

X	€		
4	42,85	1	BE-9880SL

BE-8910SL, BE-8915SL, BE-8920SL, BE-8925SL

Jogo de chave de parafusos isoladas ERGO™, com lâminas SLIM, 5 peças. Para parafusos de fenda e Phillips



ergo



BE-9881SL

X	€		
5	48,59	1	BE-9881SL

Para parafusos de fenda e Phillips

BE-8220SL, BE-8040SL, BE-8050SL
BE-8610SL, BE-8620SL

Jogo de chave de parafusos isoladas ERGO™, com lâminas SLIM, 5 peças. Para parafusos de fenda e Pozidriv



ergo

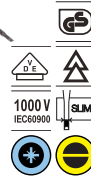

BE-9882SL

X	€		
5	50,14	1	BE-9882SL

Para parafusos de fenda e Pozidriv

BE-8220SL, BE-8040SL, BE-8050SL
BE-8810SL, BE-8820SL

Conjunto de chaves de parafusos TORX®, Phillips e chaves de fenda finas com isolamento VDE ERGO™ com pega de três componentes - 5 peças



ergo



BE-9871SL

X	€		
5	53,62	1	BE-9871SL

BE-8220SL, BE-8040SL
BE-8910SL
BE-8610SL, BE-8620SL

Conjunto de chaves de parafusos TORX®, Pozidriv e chaves de fenda finas com isolamento VDE ERGO™ com pega de três componentes - 5 peças



ergo



BE-9872SL

X	€		
5	54,77	1	BE-9872SL

BE-8220SL, BE-8040SL
BE-8910SL
BE-8810SL, BE-8820SL

Conjunto de chaves de parafusos isoladas ERGO™, 12 peças



ergo



BE-9878SL

X	€		
12	107,89	1	BE-9878SL

BE-8010S
BE-8220SL, BE-8230SL, BE-8040SL, BE-8050SL
BE-8610SL, BE-8620SL
BE-8810SL, BE-8820SL
BE-8510SL, BE-8520SL
BE-8910SL

Chave de parafusos fenda isolada



B196

Ø	L	€		
2.5 mm	75 mm	6,00	10	B196.025.075
3 mm	100 mm	5,90	10	B196.030.100
3.5 mm	100 mm	6,14	10	B196.035.100
4 mm	100 mm	7,16	10	B196.040.100
5.5 mm	125 mm	8,53	10	B196.055.125
6.5 mm	150 mm	10,92	10	B196.065.150
8 mm	175 mm	12,05	10	B196.080.175
10 mm	200 mm	15,76	10	B196.100.200
12 mm	200 mm	18,27	10	B196.120.200
2.5 mm	75 mm	6,73	1	SB196.025.075
3 mm	100 mm	6,63	1	SB196.030.100
3.5 mm	100 mm	6,90	1	SB196.035.100
4 mm	100 mm	7,88	1	SB196.040.100
5.5 mm	125 mm	9,27	1	SB196.055.125
6.5 mm	150 mm	11,64	1	SB196.065.150
8 mm	175 mm	12,79	1	SB196.080.175
10 mm	200 mm	16,49	1	SB196.100.200
12 mm	200 mm	19,05	1	SB196.120.200



Chave de parafusos isolada Phillips



B197PH

		€		
PH0	75 mm	6,13	10	B197.000.075
PH1	80 mm	7,57	10	B197.001.080
PH1	150 mm	8,56	10	B197.001.150
PH2	100 mm	9,78	10	B197.002.100
PH2	175 mm	11,76	10	B197.002.175
PH3	150 mm	12,52	10	B197.003.150
PH4	200 mm	18,54	10	B197.004.200
PH0	75 mm	6,88	1	SB197.000.075
PH1	80 mm	8,34	1	SB197.001.080
PH2	100 mm	10,52	1	SB197.002.100
PH3	150 mm	13,29	1	SB197.003.150
PH4	200 mm	19,29	1	SB197.004.200

Chave de parafusos isolada Pozidriv



B142PZ

		€		
PZ0	75 mm	6,79	10	B142.000.075
PZ1	80 mm	8,15	10	B142.001.080
PZ1	150 mm	9,57	10	B142.001.150
PZ2	100 mm	10,15	10	B142.002.100
PZ2	175 mm	11,82	10	B142.002.175
PZ3	150 mm	15,29	10	B142.003.150
PZ0	75 mm	7,55	1	SB142.000.075
PZ1	80 mm	8,89	1	SB142.001.080
PZ2	100 mm	10,92	1	SB142.002.100
PZ3	150 mm	16,05	1	SB142.003.150

Chaves de parafusos TORX isoladas



B150TORX

		€		
T10	100 mm	6,29	10	B150.010.100
T15	125 mm	6,33	10	B150.015.125
T20	125 mm	6,46	10	B150.020.125

		€		
T25	150 mm	6,68	10	B150.025.150
T10	100 mm	7,05	1	SB150.010.100
T15	125 mm	7,10	1	SB150.015.125
T20	125 mm	7,21	1	SB150.020.125
T25	150 mm	7,44	1	SB150.025.150

Chave de parafusos Phillips isolada combinada



B148

		€		
5.0mm/PH1	80 mm	8,15	10	B148.001.080
6.0mm/PH2	100 mm	10,02	10	B148.002.100
5.0mm/PH1	80 mm	10,53	1	SB148.001.080
6.0mm/PH2	100 mm	11,17	1	SB148.002.100

Chave de porca isolada



B199

		€		
5.5 mm	125 mm	11,27	5	B199.055.125
6 mm	125 mm	12,29	5	B199.060.125
7 mm	125 mm	13,17	5	B199.070.125
8 mm	125 mm	14,55	5	B199.080.125
9 mm	125 mm	16,16	5	B199.090.125
10 mm	125 mm	17,87	5	B199.100.125
11 mm	125 mm	19,56	5	B199.110.125
12 mm	125 mm	21,82	5	B199.120.125
13 mm	125 mm	24,21	5	B199.130.125
5.5 mm	125 mm	12,04	1	SB199.055.125
6 mm	125 mm	13,04	1	SB199.060.125
7 mm	125 mm	13,91	1	SB199.070.125
8 mm	125 mm	15,29	1	SB199.080.125
9 mm	125 mm	16,94	1	SB199.090.125
10 mm	125 mm	18,63	1	SB199.100.125
11 mm	125 mm	20,29	1	SB199.110.125
12 mm	125 mm	22,57	1	SB199.120.125
13 mm	125 mm	24,97	1	SB199.130.125

Chave de parafusos Pozidriv isolada combinada



B149

		€		
5.0mm/PZ1	80 mm	8,46	10	B149.001.080
6.0mm/PZ2	100 mm	10,34	10	B149.002.100
5.0mm/PZ1	80 mm	10,73	1	SB149.001.080
6.0mm/PZ2	100 mm	11,43	1	SB149.002.100

Jogo de chave de parafusos isoladas BahcoFit, 2 peças. Para parafusos entalhados e Phillips



B220.002

X	g	€		
2	90 g	13,19	1	B220.002

B196.030.100

B197.001.080

Conjunto de chaves de parafusos BahcoFit, 2 peças



B220.012

X	g	€		
2	182 g	22,07	1	B220.012

B149.001.080, B149.002.100



Jogo de chave de parafusos isoladas BahcoFit, 5 peças. Para parafusos entalhados e Phillips



B220.005

	€		
5	33,98	1	B220.005

B196.030.100, B196.040.100, B196.055.125	
B197.001.080, B197.002.100	

Jogo de chave de parafusos isoladas BahcoFit, 5 peças. Para parafusos entalhados e Pozidriv



B220.015

	€		
5	35,05	1	B220.015

B196.035.100, B196.040.100, B196.065.150	
B142.001.080, B142.002.100	

Jogo de chave de parafusos isoladas BahcoFit, 7 peças. Para parafusos entalhados e Phillips



B220.017

	€		
7	52,43	1	B220.017

B196.025.075, B196.040.100, B196.055.125, B196.065.150	
B142.000.075, B142.001.080, B142.002.100	

B196.030.100, B196.040.100, B196.055.125, B196.065.150	
B197.000.075, B197.001.080, B197.002.100	

Jogo de chave de parafusos isoladas BahcoFit, 7 peças. Para parafusos entalhados e Pozidriv



B220.027

	€		
7	46,32	1	B220.027

B196.025.075, B196.040.100, B196.055.125, B196.065.150	
B142.000.075, B142.001.080, B142.002.100	

Jogo de chave de parafusos isoladas BahcoFit, 7 peças. Para parafusos entalhados e Phillips



B220.027

	€		
7	46,32	1	B220.027

B196.030.100, B196.040.100, B196.055.125	
B197.000.075, B197.001.080, B197.002.100	
806-1-1	

Chave de parafusos isolada para parafusos de fenda



623

		€		
3.0 mm	100 mm	5,90	10	623-3-100
3.5 mm	100 mm	6,42	10	623-3.5-100
4.0 mm	100 mm	6,70	10	623-4-100
5.5 mm	125 mm	9,30	10	623-5.5-125
6.5 mm	150 mm	11,08	10	623-6.5-150

Chaves Parafusos Phillips Isolada 1000V. Série 600



625PH

		€		
PH 0	100 mm	4,12	10	625-0-100
PH 1	150 mm	7,67	10	625-1-150
PH 2	175 mm	10,68	10	625-2-175

Série 600

Jogo chaves Parafusos Isoladas 1000V 6 peças. Fenda e PH



620-6

	€		
6	49,54	1	620-6

Fenda e PH

623-4-100, 623-3-100, 623-5.5-125, 623-6.5-150	
625-1-150, 625-2-175	



Chave roquete 1000V com kit de lâminas substituíveis de 6 peças



808061

		€		
7	85 x 85 x 218 mm	100,89	5	808061

808060		
8610SL-2P, 8620SL-2P		
8010SL-2P, 8050SL-2P, 8220SL-2P, 8040SL-2P		

Chave roquete 1000V com kit de lâminas substituíveis de 6 peças



808062

		€		
7	85 x 85 x 215 mm	100,89	5	808062

808060		
8820SL-2P, 8810SL-2P		
8010SL-2P, 8050SL-2P, 8220SL-2P, 8040SL-2P		

Chave roquete 1000V para ser usado com as lâminas substituíveis



808060

		€		
36 mm	122 mm	39,96	1	808060

Lâminas substituíveis isoladas com diâmetro reduzido para parafusos de Fendas, 100mm



8010SL-2P - 8050SL-2P

		€		
0.4 mm	2.5 mm	13,04	1	8010SL-2P
0.5 mm	3.0 mm	13,04	1	8220SL-2P
0.8 mm	4.0 mm	13,70	1	8040SL-2P
1.0 mm	5.5 mm	13,70	1	8050SL-2P

Lâminas substituíveis isoladas com diâmetro reduzido para parafusos Phillips, 100mm



8610SL-2P - 8620SL-2P

	€		
1	13,70	1	8610SL-2P
2	13,70	1	8620SL-2P

Lâminas substituíveis isoladas com diâmetro reduzido para parafusos Pozidriv, 100mm



8810SL-2P - 8820SL-2P

	€		
1	13,70	1	8810SL-2P
2	13,70	1	8820SL-2P

Isolert utskiftbar klinge med redusert diameter for. spor/phillips (combi) skruer, 100mm



8510SL-2P - 8520SL-2P

	€		
5.0/PH1	20,31	1	8510SL-2P
6.0/PH2	20,31	1	8520SL-2P

spor/phillips (combi) skruer, 100mm

Lâminas substituíveis isoladas com diâmetro reduzido para parafusos de Fendas/Pozidriv(combi), 100mm



8710SL-2P - 8720SL-2P

	€		
5.0/PZ1	20,31	1	8710SL-2P
6.0/PZ2	20,31	1	8720SL-2P

Lâminas substituíveis isoladas com diâmetro reduzido para parafusos TORX®, 100mm



8910SL-2P - 8930SL-2P

	€		
10	15,23	1	8910SL-2P
15	15,23	1	8915SL-2P
20	15,23	1	8920SL-2P
25	15,23	1	8925SL-2P
30	15,23	1	8930SL-2P

ALICATES

Alicate corte Isolado 1000V. Para arame de piano e materiais mais macios como o plástico ou de cobre



ergo®



2101S

		€		
3.7 mm	2.0 mm	26,11	3	2101S-140
3.8 mm	2.5 mm	28,14	3	2101S-160
4.0 mm	2.7 mm	31,47	3	2101S-180

Para arame de piano e materiais mais macios como o plástico ou de cobre

Alicate cr lateral c/bordos progr., punhos isolados. P/corda piano e mat. + macios c/o plástico ou cobre



2101S-200



Co	Fe+	€		
4.5 mm	3.0 mm	38,80	3	2101S-200

Corta cabos Isolado 1000V



2250V



L		€		
170 mm	0-10 mm	109,12	2	2250V-170
230 mm	0-15 mm	127,15	2	2250V-230

Alicates universais ERGO™ com pegas de dois componentes e acabamento em fosfato



ergo



2628S



Fe+	Piano	€		
2.0 mm	1.8 mm	29,81	3	2628 S-160
2.5 mm	2.0 mm	33,03	3	2628 S-180
3.0 mm	2.5 mm	36,12	3	2628 S-200

Modelo isolado 1000V

Alicate de corte lateral isolado



2171V



Co	L	€		
2.7 mm	160 mm	41,49	2	2171V-160
2.8 mm	180 mm	44,49	2	2171V-180
4.0 mm	200 mm	48,05	2	2171V-200

Corta Cabos Isolado 1000V



2820VBC



L	€		
630 mm	227,32	1	2820VBC

Alicates universais reforçados com pegas de dois componentes e acabamento cromado



ergo



2630SC



L	€		
180 mm	25,27	3	2630SC-180

Alicate corte frontal Isolado 1000V



527V



Co	L	€		
2 mm	160 mm	48,74	2	527V-160
2.5 mm	200 mm	53,47	2	527V-200

Alicate de corte lateral - niquelado e cromado. Arame de aço - Modelo isolado



2674 NVDE



Co	Fe+	€		
3.7 mm	2.0 mm	86,16	1	2674 NVDE

Arame de aço - Modelo isolado

Alicate Universal Isolado 1000V



2678V



Co	L	€		
2.7 mm	160 mm	41,78	2	2678V-160
3.0 mm	180 mm	45,55	2	2678V-180
4.0 mm	200 mm	48,99	2	2678V-200



Alicates de pontas ERGO™ com pegas de dois componentes isoladas e acabamento em fosfato



ergo



2430S



Cu	Fe	€		
2.5 mm	1.8 mm	27,11	3	2430S-140
3.0 mm	1.8 mm	27,76	3	2430 S-160
3.0 mm	1.8 mm	30,43	3	2430 S-200

Arame de aço - Modelo isolado 1000V

Alicates de pontas curvas ERGO™ com pegas de dois componentes isoladas e acabamento em fosfato



ergo



2521S



L	€		
140 mm	32,34	3	2521S-140
160 mm	34,03	3	2521S-160

Alicates Pontas chatas Isolado 1000V



2421V



L	€		
160 mm	38,70	2	2421V-160

Alicates de pontas 45° ERGO™ com pegas de dois componentes isoladas e acabamento em fosfato



ergo



2427S



Cu	Fe	€		
3.0 mm	1.8 mm	33,72	3	2427S-160
3.0 mm	1.8 mm	33,98	3	2427 S-200

Arame de aço - Modelo isolado 1000V

Alicate Pontas Semi Redondas Isolado 1000V. Para cabo de aço



2430V



Cu	L	€		
3.0 mm	160 mm	46,13	2	2430V-160
3.0 mm	200 mm	46,45	2	2430V-200

Para cabo de aço

Alicate de ponta redonda isolada



2521V



L	€		
160 mm	39,32	2	2521V-160

Alicates de pontas planas e compridas ERGO™ com pegas de dois componentes e acabamento em fosfato



ergo



2421S



L	€		
140 mm	32,60	3	2421S-140
160 mm	32,60	3	2421S-160
180 mm	43,32	3	2421S-180

Alicates de Pontas Isolado 1000V dobradas 60°



2427V



Cu	L	€		
3.0 mm	200 mm	52,01	2	2427V-200

Alicates para descarnar ERGO™ com pegas de dois componentes isoladas e acabamento em fosfato



ergo



2223S



L	€		
165 mm	33,03	3	2223 S-150

para fios e cabos de cobre

Alicate Descarnar Isolado 1000V. Para arame de cobre e cablagem



2223V

L	W	€	Box	Fish	Code
160 mm	0.5-5 mm	52,01	2		2223V-160

Para arame de cobre e cablagem

Alicate de bomba de água de ajuste rápido isolados com cabo de dois componentes



7224S

L	€	Box	Fish	Code
16 250 mm	39,34	4		7224S

CHAVES DE BOCAS

Chaves Crescentes Isoladas 1000V



8070V - 8074V

L	€	Box	Fish	Code
165mm/6"	39,14	2		8070V
205mm/8"	47,59	2		8071V
260mm/10"	53,05	2		8072V
310mm/12"	70,38	2		8073V
390mm/15"	113,80	2		8074V

Chave crescente isolada



8070VL-8073VL

L	€	Box	Fish	Code
160mm/6"	47,79	1		8070VL
210mm/8"	55,77	1		8071VL
260mm/10"	65,75	1		8072VL
310mm/12"	86,29	1		8073VL

Chaves Crescentes Laterais Isoladas 1000V



8071VLT - 8073VLT

L	€	Box	Fish	Code
205mm/8"	157,67	1		8071VLT
255mm/10"	176,30	1		8072VLT
305mm/12"	192,08	1		8073VLT

Chave Bocas Isolada 1000V



6MV

W	€	Box	Fish	Code
6 mm	24,09	5		6MV-6
7 mm	24,41	5		6MV-7
8 mm	22,18	5		6MV-8
9 mm	23,21	5		6MV-9
10 mm	23,48	5		6MV-10
11 mm	23,63	5		6MV-11
12 mm	24,81	5		6MV-12
13 mm	26,07	5		6MV-13
14 mm	26,07	5		6MV-14
15 mm	25,96	5		6MV-15
16 mm	27,35	5		6MV-16
17 mm	27,86	3		6MV-17
18 mm	28,50	3		6MV-18
19 mm	29,57	3		6MV-19
20 mm	31,01	3		6MV-20
21 mm	33,43	3		6MV-21
22 mm	34,88	3		6MV-22
23 mm	38,87	3		6MV-23

W	€	Box	Fish	Code
24 mm	40,35	3		6MV-24
27 mm	46,52	2		6MV-27
30 mm	51,87	2		6MV-30
32 mm	53,14	2		6MV-32

Chave Luneta Isolada 1000V



2MV

W	€	Box	Fish	Code
6.0 mm	28,70	5		2MV-6
7.0 mm	28,70	5		2MV-7
8.0 mm	30,22	5		2MV-8
9.0 mm	30,82	5		2MV-9
10.0 mm	30,73	5		2MV-10
11.0 mm	31,01	5		2MV-11
12.0 mm	31,01	5		2MV-12
13.0 mm	33,26	5		2MV-13
14.0 mm	34,19	5		2MV-14
15.0 mm	35,46	5		2MV-15
16.0 mm	35,95	5		2MV-16
17.0 mm	37,05	3		2MV-17
18.0 mm	37,71	3		2MV-18
19.0 mm	38,97	3		2MV-19
21.0 mm	41,01	3		2MV-21
22.0 mm	41,32	3		2MV-22
23.0 mm	44,02	3		2MV-23
24.0 mm	45,44	3		2MV-24

Chaves de Cachimbo em T Isoladas 1000V



28MV

W	€	Box	Fish	Code
8.0 mm	36,51	2		28MV-8
9.0 mm	36,51	2		28MV-9
10.0 mm	36,85	2		28MV-10
11.0 mm	37,32	2		28MV-11
12.0 mm	37,65	2		28MV-12
13.0 mm	37,97	2		28MV-13
14.0 mm	42,54	2		28MV-14
15.0 mm	43,03	2		28MV-15
16.0 mm	44,18	2		28MV-16
17.0 mm	44,81	2		28MV-17
18.0 mm	46,07	2		28MV-18
19.0 mm	46,07	2		28MV-19
20.0 mm	45,92	2		28MV-20
21.0 mm	46,24	2		28MV-21
22.0 mm	48,45	2		28MV-22



Chaves Hexagonais Isoladas 1000V



1999MV



Ø	€		
3 mm	15,40	5	1999MV-3
4 mm	15,95	5	1999MV-4
5 mm	15,79	5	1999MV-5
6 mm	16,10	5	1999MV-6
7 mm	16,86	5	1999MV-7
8 mm	17,81	5	1999MV-8
9 mm	18,42	5	1999MV-9
10 mm	19,97	3	1999MV-10
12 mm	22,45	3	1999MV-12

ROQUETES E CHAVES DE CAIXA ISOLADAS

Chaves de Caixa 1/2" Isoladas 1000V



7800DMV



Ø	€		
8 mm	23,98	10	7800DMV-8
10 mm	24,68	10	7800DMV-10
11 mm	24,68	10	7800DMV-11
12 mm	24,68	10	7800DMV-12
13 mm	24,68	10	7800DMV-13
14 mm	24,54	10	7800DMV-14
15 mm	24,54	10	7800DMV-15
16 mm	25,23	10	7800DMV-16
17 mm	25,39	10	7800DMV-17
18 mm	25,00	10	7800DMV-18
19 mm	25,72	10	7800DMV-19
20 mm	26,10	10	7800DMV-20
21 mm	25,71	10	7800DMV-21
22 mm	25,87	10	7800DMV-22
24 mm	27,24	5	7800DMV-24
27 mm	28,08	5	7800DMV-27
30 mm	30,58	5	7800DMV-30
32 mm	31,73	5	7800DMV-32

Chave de Roquete 1/2" Isolada 1000V



8150-1/2V



L	€		
270 mm	195,16	1	8150-1/2V

Chave Cabo em T Isolada 1000V



8154-1/2V



L	€		
200 mm	62,24	1	8154-1/2V
190 mm			

Extensão 1/2" Isoladas 1000V



8160-1/2V - 8162-1/2V



L	€		
125 mm	46,61	1	8160-1/2V
250 mm	49,91	1	8162-1/2V

TESOURAS E FACAS

Tesoura para Electricista Isolada 1000V



SC127V



Ø	L	€	
50 mm	130 mm	23,79	5 SC127V

Tesoura para Electricista extra forte Isolada 1000V



SC150NGV



Ø	L	€	
38 mm	150 mm	36,71	5 SC150NGV

Navalha Electricista Isolada 1000V



2820VP



Ø	L	€	
50 mm	180 mm	30,08	2 2820VP

Navalha Curva Electricista Isolada 1000V



2820VPC



		€		
50 mm	180 mm	32,63	2	2820VPC

FERRAMENTAS DE PRECISÃO

Pinças de segurança 1000V



2820VTEE



	€		
145 mm	32,29	1	2820VTEE

Luvas Isoladas 1000V



2820VG



	€		
500 V	68,52	1	2820VG05
1000 V	82,41	1	2820VG10

Navalha Curva Electricista Isolada 1000V



2820VHELP



		€		
38 mm	180 mm	59,99	1	2820VHELP

EQUIPAMENTO DE PROTEÇÃO

Saca Fusíveis Isolado 1000V



2820VFP



	€		
458 g	122,19	1	2820VFP

Luvas de Algodão. 1 tamanho



2820VGCOT

	€		
50 g	4,89	1	2820VGCOT

Luvas de algodão para utilizar por baixo das luvas isoladas

Faca Electricista Isolada 1000V. Tampa de protecção



2820VDE



		€		
55.5 mm	180 mm	24,33	10	2820VDE

Tampa de protecção

Tapete Isolante 1000V



2820VM



		€		
1000 mm	1000 mm	227,90	1	2820VM

CONJUNTOS DE FERRAMENTAS

Conjunto de alicates isolados ERGO™ - 3 Pcs



ergo



9897S/3

		€		
3	50 x 180 x 400 mm	92,80	1	9897S/3

2628 S-180

1000 V



2101S-160

1000 V



2430 S-200

1000 V



Jogo chaves bocas Isolado 1000V. 8 pcs:10-11-12-13-14-17-18-19 mm



6MV/



	€		
8 mm	210,84	1	6MV/8T

8 pcs:10-11-12-13-14-17-18-19 mm

6MV-10, 6MV-11, 6MV-12, 6MV-13, 6MV-14, 6MV-17, 6MV-18, 6MV-19	1000 V IEC60900	
--	-----------------	--

Insulated open end wrench set. 10 pcs



6MV/10T 1



	€		
10 mm	282,64	1	6MV/10T

10 pcs

6MV-10, 6MV-11, 6MV-12, 6MV-13, 6MV-14, 6MV-16, 6MV-17, 6MV-18, 6MV-19, 6MV-22	1000 V IEC60900	
--	-----------------	--

Jogo Ferramentas Isoladas 1000V. 11 peças



7811DMV



		€		
11	270 x 79 x 350 mm	534,04	1	7811DMV

11 peças

7800DMV-13, 7800DMV-10, 7800DMV-11, 7800DMV-22, 7800DMV-17, 7800DMV-19, 7800DMV-20	1000 V IEC60900	
8150-1/2V	1000 V IEC60900	
8154-1/2V	1000 V IEC60900	
8160-1/2V	1000 V IEC60900	
BE-8050S		

Conjunto de ferramentas para electricista



3045/1VDE



		€		
10	225 x 70 x 300 mm	443,51	1	3045/1VDE

BE-8010S, BE-8040S, BE-8050S, BE-8220S, BE-8230S, BE-8255S		
BE-8620S		
2171V-160	1000 V IEC60900	
2430V-160	1000 V IEC60900	
2678V-180	1000 V IEC60900	

Jogo Ferramentas Isoladas 1000V. 10 peças



3045V-1



		€		
10	60 x 240 x 330 mm	303,63	1	3045V-1

10 peças

2171V-160	1000 V IEC60900	
2678V-180	1000 V IEC60900	
2223V-160	1000 V IEC60900	
BE-8220S, BE-8040S, BE-8050S		
BE-8610S, BE-8620S		
2820VP	1000 V IEC60900	
SC127V	1000 V IEC60900	

Conjunto de 19 peças isoladas num saco de couro. 19 pcs



3045V-2



		€		
19	200 x 285 x 445 mm	759,63	1	3045V-2

19 pcs

2171V-160	1000 V IEC60900	
2678V-180	1000 V IEC60900	
2430V-160	1000 V IEC60900	
2223V-160	1000 V IEC60900	
BE-8220S, BE-8040S, BE-8050S, BE-8255S		
BE-8610S, BE-8620S		
6MV-10, 6MV-11, 6MV-13, 6MV-12, 6MV-14, 6MV-17, 6MV-19	1000 V IEC60900	
2820VP	1000 V IEC60900	
SC150NGV	1000 V IEC60900	



Ferramentas que não produzem faíscas



CHAVES DE BOCAS

Chave ajustável antichispa AL-BR



NS001

↺	L	€	📦	🐟
18 mm	150mm/6"	104,53	5	NS001-150
24 mm	200mm/8"	119,66	5	NS001-200
30 mm	250mm/10"	160,91	5	NS001-250
36 mm	300mm/12"	204,94	5	NS001-300
46 mm	375mm/15"	316,33	5	NS001-375
55 mm	450mm/18"	440,13	3	NS001-450
65 mm	600mm/24"	715,21	1	NS001-600
75 mm	900mm/36"	1.608,05	1	NS001-900

Chave inglesa anti-chispa



NSB001

↺	L	€	📦	🐟
18 mm	150mm/6"	148,54	5	NSB001-150
24 mm	200mm/8"	185,67	5	NSB001-200
30 mm	250mm/10"	247,58	5	NSB001-250
36 mm	300mm/12"	275,08	5	NSB001-300
48 mm	375mm/15"	417,45	5	NSB001-375
55 mm	450mm/18"	567,02	3	NSB001-450
65 mm	600mm/24"	1.046,88	3	NSB001-600
75 mm	900mm/36"	2.343,32	1	NSB001-900

BAM/ZBF/003/21

Chave combinada anti-chispa



NS002

↺	€	📦	🐟
6 mm	34,97	5	NS002-6
7 mm	39,64	5	NS002-7
8 mm	39,64	5	NS002-8
9 mm	40,96	5	NS002-9
10 mm	35,62	10	NS002-10
11 mm	44,65	5	NS002-11
12 mm	44,65	5	NS002-12

↺	€	📦	🐟
13 mm	44,65	10	NS002-13
14 mm	47,29	5	NS002-14
15 mm	49,92	5	NS002-15
16 mm	52,55	5	NS002-16
17 mm	65,67	10	NS002-17
18 mm	68,30	5	NS002-18
19 mm	70,92	10	NS002-19
20 mm	73,56	5	NS002-20
21 mm	76,18	5	NS002-21
22 mm	78,80	10	NS002-22
23 mm	84,07	5	NS002-23
24 mm	89,33	10	NS002-24
25 mm	91,94	5	NS002-25
26 mm	105,09	5	NS002-26
27 mm	105,09	5	NS002-27
28 mm	113,61	5	NS002-28
29 mm	116,25	10	NS002-29
30 mm	124,77	10	NS002-30
31 mm	131,36	5	NS002-31
32 mm	137,91	5	NS002-32
33 mm	150,46	5	NS002-33
34 mm	154,18	5	NS002-34
35 mm	157,62	5	NS002-35
36 mm	164,19	5	NS002-36
38 mm	170,75	5	NS002-38
40 mm	183,89	5	NS002-40
41 mm	210,15	5	NS002-41
42 mm	223,30	5	NS002-42
46 mm	236,44	5	NS002-46
50 mm	302,10	5	NS002-50
52 mm	304,75	5	NS002-52
55 mm	309,06	5	NS002-55
60 mm	343,49	1	NS002-60
65 mm	435,97	1	NS002-65
70 mm	502,04	1	NS002-70
75 mm	581,29	1	NS002-75
80 mm	686,98	1	NS002-80

BAM/ZBF/002/21

Chave boca luneta antichispa CU-BE



NSB002

↺	€	📦	🐟
6 mm	60,61	5	NSB002-6
7 mm	60,61	5	NSB002-7
8 mm	60,61	5	NSB002-8
9 mm	49,00	5	NSB002-9
10 mm	48,60	5	NSB002-10
11 mm	52,55	5	NSB002-11
12 mm	57,80	5	NSB002-12
13 mm	60,42	5	NSB002-13
17 mm	85,37	5	NSB002-17
14 mm	63,05	5	NSB002-14
15 mm	72,12	5	NSB002-15
16 mm	74,88	5	NSB002-16
18 mm	89,33	5	NSB002-18
19 mm	91,94	5	NSB002-19
20 mm	94,57	5	NSB002-20
21 mm	102,47	5	NSB002-21
22 mm	105,09	5	NSB002-22
25 mm	131,36	5	NSB002-25
23 mm	110,33	5	NSB002-23
26 mm	137,39	5	NSB002-26

↺	€	📦	🐟
24 mm	124,77	5	NSB002-24
27 mm	140,84	5	NSB002-27
28 mm	173,76	5	NSB002-28
29 mm	177,81	5	NSB002-29
30 mm	191,95	5	NSB002-30
31 mm	232,37	1	NSB002-31
32 mm	242,46	10	NSB002-32
33 mm	244,03	1	NSB002-33
34 mm	249,62	1	NSB002-34
35 mm	252,57	1	NSB002-35
36 mm	272,77	5	NSB002-36
38 mm	292,98	1	NSB002-38
40 mm	321,26	1	NSB002-40
41 mm	345,50	5	NSB002-41
42 mm	363,70	1	NSB002-42
46 mm	402,09	1	NSB002-46
50 mm	444,51	1	NSB002-50
52 mm	460,70	1	NSB002-52
55 mm	484,92	1	NSB002-55
60 mm	525,33	1	NSB002-60
65 mm	666,78	1	NSB002-65
70 mm	767,80	1	NSB002-70
75 mm	889,05	1	NSB002-75
80 mm	1.050,68	1	NSB002-80

BAM/ZBF/003/21

Chaves combinadas imperiais anti-chispa Alumínio bronze



NS003



↺	€	📦	🐟
1/4 in	32,49	1	NS003-8
11/32 in	37,51	1	NS003-11
3/8 in	38,63	1	NS003-12
7/16 in	40,60	1	NS003-14
1/2 in	45,56	1	NS003-16
9/16 in	49,52	1	NS003-18
5/8 in	54,10	1	NS003-20
3/4 in	68,73	1	NS003-24
7/8 in	76,76	1	NS003-28
15/16 in	95,43	1	NS003-30

Chaves combinadas imperiais anti-chispa Cobre Berílio



NSB003

↺	€	📦	🐟
1/4 in	1.518,53	1	NSB003-8
5/16 in	33,09	1	NSB003-10
11/32 in	28,02	1	NSB003-11
3/8 in	28,02	5	NSB003-12



	€		
13/32 in	33,09	1	NSB003-13
7/16 in	44,69	1	NSB003-14
1/2 in	78,38	5	NSB003-16
9/16 in	78,38	1	NSB003-18
19/32 in	82,34	1	NSB003-19
5/8 in	74,16	1	NSB003-20
11/16 in	49,31	5	NSB003-22
3/4 in	777,79	5	NSB003-24
25/32 in	1.137,58	1	NSB003-25
13/16 in	897,77	1	NSB003-26
7/8 in	1.415,63	5	NSB003-28
15/16 in	1.157,03	1	NSB003-30
31/32 in	1.353,28	1	NSB003-31
1 in	477,92	1	NSB003-32
1.1/16 in	438,56	1	NSB003-34
1.1/8 in	547,60	1	NSB003-36
1.3/16 in	602,70	1	NSB003-38
1.1/4 in	841,41	1	NSB003-40
1.5/16 in	670,60	1	NSB003-42
1.3/8 in	1.045,55	5	NSB003-44
1.7/16 in	51,48	1	NSB003-46
1.1/2 in	53,92	1	NSB003-48
1.9/16 in	109,62	1	NSB003-50
1.5/8 in	339,88	1	NSB003-52
1.11/16 in	349,84	1	NSB003-54
1.3/4 in	5,14	1	NSB003-56
1.13/16 in	5,34	1	NSB003-58
1.7/8 in	6,13	1	NSB003-60
1.15/16 in	6,32	1	NSB003-62
2 in	50,62	5	NSB003-64
2.1/8 in	111,80	1	NSB003-68
2.1/4 in	131,71	1	NSB003-72
2.1/2 in	40,81	1	NSB003-80
2.5/8 in	918,07	1	NSB003-84
2.3/4 in	9,42	1	NSB003-88



BAM/ZBF/003/21

Chave de bocas duplas anti-chispa



NS006

	€		
6x7 mm	17,98	1	NS006-0607
6x8 mm	18,31	1	NS006-0608
7x8 mm	17,99	1	NS006-0708
7x9 mm	18,29	1	NS006-0709
8x9 mm	17,99	1	NS006-0809
8x10 mm	19,04	1	NS006-0810
9x10 mm	19,37	1	NS006-0910
9x11 mm	23,28	1	NS006-0911
10x11 mm	22,59	1	NS006-1011
10x12 mm	25,39	1	NS006-1012
10x13 mm	25,82	1	NS006-1013
10x14 mm	26,03	1	NS006-1014
11x13 mm	29,63	1	NS006-1113
11x14 mm	30,12	1	NS006-1114
12x13 mm	28,24	1	NS006-1213
12x14 mm	38,57	1	NS006-1214
13x15 mm	42,32	1	NS006-1315
14x15 mm	33,89	1	NS006-1415
14x16 mm	42,32	1	NS006-1416
14x17 mm	33,89	1	NS006-1417
16x17 mm	36,70	1	NS006-1617

	€		
16x18 mm	36,70	1	NS006-1618
17x19 mm	36,70	1	NS006-1719
17x22 mm	42,36	1	NS006-1722
18x19 mm	42,36	1	NS006-1819
18x20 mm	45,00	1	NS006-1820
19x20 mm	45,18	1	NS006-1920
19x22 mm	50,83	1	NS006-1922
19x24 mm	50,83	1	NS006-1924
20x22 mm	50,83	1	NS006-2022
21x22 mm	51,25	1	NS006-2122
21x23 mm	53,64	1	NS006-2123
22x23 mm	56,48	1	NS006-2223
22x24 mm	56,94	1	NS006-2224
22x27 mm	63,53	1	NS006-2227
23x26 mm	64,63	1	NS006-2326
24x25 mm	69,40	1	NS006-2425
24x26 mm	70,60	1	NS006-2426
24x27 mm	49,92	1	NS006-2427
24x30 mm	56,44	1	NS006-2430
25x28 mm	52,55	1	NS006-2528
26x29 mm	53,91	1	NS006-2629
27x29 mm	60,42	1	NS006-2729
27x30 mm	75,35	1	NS006-2730
27x32 mm	84,40	1	NS006-2732
28x30 mm	84,40	1	NS006-2830
30x31 mm	87,41	1	NS006-3031
30x32 mm	105,88	1	NS006-3032
30x34 mm	92,83	1	NS006-3034
30x36 mm	92,83	1	NS006-3036
32x34 mm	92,83	1	NS006-3234
32x35 mm	92,83	1	NS006-3235
32x36 mm	134,11	1	NS006-3236
33x35 mm	141,13	1	NS006-3335
34x36 mm	141,13	1	NS006-3436
35x36 mm	141,13	1	NS006-3536
36x38 mm	206,20	1	NS006-3638
36x41 mm	206,20	1	NS006-3641
38x42 mm	229,11	1	NS006-3642
41x46 mm	211,77	1	NS006-4146
46x50 mm	297,85	1	NS006-4650
50x52 mm	302,43	1	NS006-5052
50x55 mm	307,01	1	NS006-5055
50x60 mm	311,59	1	NS006-5060
50x62 mm	423,53	1	NS006-5062
55x60 mm	451,76	1	NS006-5560
60x65 mm	550,59	1	NS006-6065
65x70 mm	564,71	1	NS006-6570



BAM/ZBF/002/21

Chave de bocas duplas antichispa CU-BE



NSB006

	€		
6X7 mm	22,74	1	NSB006-0607
6X8 mm	23,16	1	NSB006-0608
7X8 mm	25,76	1	NSB006-0708
7X9 mm	26,19	1	NSB006-0709

	€		
8X9 mm	25,78	1	NSB006-0809
8X10 mm	27,28	1	NSB006-0810
9X10 mm	27,73	1	NSB006-0910
9X11 mm	33,34	1	NSB006-0911
10X11 mm	33,89	1	NSB006-1011
10X12 mm	36,70	1	NSB006-1012
10X13 mm	37,32	1	NSB006-1013
10X14 mm	39,53	1	NSB006-1014
11X13 mm	45,00	1	NSB006-1113
11X14 mm	45,75	1	NSB006-1114
12X13 mm	45,18	1	NSB006-1213
12X14 mm	45,55	1	NSB006-1214
13X15 mm	49,98	1	NSB006-1315
14X15 mm	50,83	1	NSB006-1415
14X16 mm	59,36	1	NSB006-1416
14X17 mm	60,85	1	NSB006-1417
16X17 mm	59,30	1	NSB006-1617
16X18 mm	59,77	1	NSB006-1618
17X19 mm	67,96	1	NSB006-1719
17X22 mm	75,52	1	NSB006-1722
18X19 mm	76,78	1	NSB006-1819
18X20 mm	77,41	1	NSB006-1820
19X20 mm	78,67	1	NSB006-1920
19X22 mm	79,93	1	NSB006-1922
19X24 mm	88,26	1	NSB006-1924
20X22 mm	87,53	1	NSB006-2022
21X22 mm	88,26	1	NSB006-2122
21X23 mm	88,97	1	NSB006-2123
22X23 mm	89,68	1	NSB006-2223
22X24 mm	90,40	1	NSB006-2224
22X27 mm	95,50	1	NSB006-2227
23X26 mm	102,60	1	NSB006-2326
24X25 mm	104,31	1	NSB006-2425
24X26 mm	106,01	1	NSB006-2426
24X27 mm	115,96	1	NSB006-2427
24x30 mm	117,42	1	NSB006-2430
25x28 mm	119,37	1	NSB006-2528
26x29 mm	128,84	1	NSB006-2629
27-29 mm	128,84	1	NSB006-2729
27x30 mm	128,84	1	NSB006-2730
27x32 mm	144,29	1	NSB006-2732
28x30 mm	144,29	1	NSB006-2830
30x31 mm	149,45	1	NSB006-3031
30x32 mm	155,30	1	NSB006-3032
30x34 mm	164,94	1	NSB006-3034
30x36 mm	164,94	1	NSB006-3036
32x34 mm	164,94	1	NSB006-3234
32x35 mm	164,94	1	NSB006-3235
32x36 mm	164,94	1	NSB006-3236
33x35 mm	164,94	1	NSB006-3335
34x36 mm	164,94	1	NSB006-3436
35x36 mm	164,94	1	NSB006-3536
36x38 mm	240,97	1	NSB006-3638
36x41 mm	240,97	1	NSB006-3641
38x42 mm	267,75	1	NSB006-3642
41x46 mm	310,59	1	NSB006-4146
46x50 mm	381,17	1	NSB006-4650
50x52 mm	387,05	1	NSB006-5052
50X55 mm	392,90	1	NSB006-5055
50X60 mm	398,76	1	NSB006-5060
50X62 mm	404,63	1	NSB006-5062
55X60 mm	516,05	1	NSB006-5560
60X65 mm	539,51	1	NSB006-6065
65X70 mm	574,69	1	NSB006-6570

BAM/ZBF/003/21



Chave de luneta anti-chispa



NS010

↕	€		
6x7 mm	35,45	1	NS010-0607
7x9 mm	35,45	1	NS010-0709
8x9 mm	37,62	1	NS010-0809
9x11 mm	39,80	1	NS010-0911
10x11 mm	39,80	1	NS010-1011
10x12 mm	41,34	1	NS010-1012
12x14 mm	42,91	1	NS010-1214
13x15 mm	50,99	1	NS010-1315
14x17 mm	50,99	1	NS010-1417
16x18 mm	67,77	1	NS010-1618
17x19 mm	74,61	1	NS010-1719
17x22 mm	82,07	1	NS010-1722
18x19 mm	74,61	1	NS010-1819
19x21 mm	90,77	1	NS010-1921
19x22 mm	92,93	1	NS010-1922
20x22 mm	95,12	1	NS010-2022
21x23 mm	102,59	1	NS010-2123
22x24 mm	111,91	1	NS010-2224
24x27 mm	131,80	1	NS010-2427
25x28 mm	147,36	1	NS010-2528
26x28 mm	150,38	1	NS010-2628
27x30 mm	153,42	1	NS010-2730
27x32 mm	169,26	1	NS010-2732
30x32 mm	179,68	1	NS010-3032
30x36 mm	224,58	1	NS010-3036
32x36 mm	269,51	1	NS010-3236
36x41 mm	404,26	1	NS010-3641
41x46 mm	440,77	1	NS010-4146
46x50 mm	468,31	1	NS010-4650

BAM/ZBF/002/21

Chave de lunetas planas duplas antichispa CU-BE



NSB010

↕	€		
6X7 mm	47,42	1	NSB010-0607
7X9 mm	47,42	1	NSB010-0709
8X9 mm	46,45	1	NSB010-0809
9X11 mm	50,06	1	NSB010-0911

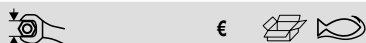

↕	€		
10X11 mm	50,06	1	NSB010-1011
10X12 mm	55,48	1	NSB010-1012
12X14 mm	60,93	1	NSB010-1214
13X15 mm	72,74	1	NSB010-1315
14X17 mm	72,74	1	NSB010-1417
16X18 mm	96,98	1	NSB010-1618
17X19 mm	106,95	1	NSB010-1719
17X22 mm	115,31	1	NSB010-1722
18X19 mm	106,95	1	NSB010-1819
19X21 mm	117,35	1	NSB010-1921
19X22 mm	118,25	1	NSB010-1922
20X22 mm	119,14	1	NSB010-2022
21X23 mm	127,84	1	NSB010-2123
22X24 mm	151,79	1	NSB010-2224
24X27 mm	164,83	1	NSB010-2427
25X28 mm	183,84	1	NSB010-2528
26X28 mm	194,48	1	NSB010-2628
27X30 mm	205,10	1	NSB010-2730
27X32 mm	212,38	1	NSB010-2732
30X32 mm	239,20	1	NSB010-3032
30X36 mm	299,01	1	NSB010-3036
32X36 mm	358,80	1	NSB010-3236
36X41 mm	538,19	1	NSB010-3641
41X46 mm	650,31	1	NSB010-4146
46X50 mm	731,60	1	NSB010-4650

BAM/ZBF/003/21

Chaves de lunetas duplas offset antichispa AL-BR



NS011

↕	€		
6x7 mm	24,85	1	NS011-0607
8x9 mm	26,83	1	NS011-0809
10x11 mm	32,47	1	NS011-1011
12x13 mm	42,36	1	NS011-1213
14x15 mm	48,01	1	NS011-1415
16x17 mm	52,24	1	NS011-1617
18x19 mm	64,94	1	NS011-1819
20x22 mm	76,22	1	NS011-2022
21x23 mm	79,08	1	NS011-2123
24x26 mm	96,83	1	NS011-2426
25x28 mm	96,83	1	NS011-2528
27x29 mm	106,62	1	NS011-2729
30x32 mm	130,56	1	NS011-3032

BAM/ZBF/002/21

Chaves de lunetas duplas offset antichispa CU-BE



NSB011

↕	€		
6x7 mm	29,65	1	NSB011-0607
8x9 mm	32,01	1	NSB011-0809
10x11 mm	40,95	1	NSB011-1011
12x13 mm	59,30	1	NSB011-1213
14x15 mm	73,41	1	NSB011-1415
16x17 mm	84,70	1	NSB011-1617
18x19 mm	107,29	1	NSB011-1819
20x22 mm	129,87	1	NSB011-2022
21x23 mm	135,52	1	NSB011-2123
24x26 mm	167,51	1	NSB011-2426
25x28 mm	168,02	1	NSB011-2528
27x29 mm	182,12	1	NSB011-2729
30x32 mm	225,87	1	NSB011-3032



BAM/ZBF/003/21

Chave de boca simples anti-chispa



NS100

↕	€		
17 mm	77,16	1	NS100-17
19 mm	80,23	1	NS100-19
22 mm	83,33	1	NS100-22
24 mm	89,49	1	NS100-24
25 mm	100,32	1	NS100-25
27 mm	101,25	1	NS100-27
28 mm	102,22	1	NS100-28
29 mm	104,92	1	NS100-29
30 mm	105,92	1	NS100-30
32 mm	111,49	1	NS100-32
33 mm	118,05	1	NS100-33
34 mm	140,21	1	NS100-34
35 mm	146,60	1	NS100-35
36 mm	148,00	1	NS100-36
37 mm	162,03	1	NS100-37
38 mm	163,56	1	NS100-38
41 mm	177,45	1	NS100-41
42 mm	207,96	1	NS100-42



	€		
45 mm	223,76	1	NS100-45
46 mm	225,89	1	NS100-46
47 mm	243,05	1	NS100-47
50 mm	262,33	1	NS100-50
52 mm	288,57	1	NS100-52
54 mm	300,92	1	NS100-54
55 mm	300,92	1	NS100-55
56 mm	315,24	1	NS100-56
58 mm	378,05	1	NS100-58
60 mm	381,66	1	NS100-60
63 mm	404,92	1	NS100-63
65 mm	416,64	1	NS100-65
67 mm	495,99	1	NS100-67
70 mm	547,81	1	NS100-70
71 mm	573,90	1	NS100-71
75 mm	616,88	1	NS100-75
77 mm	688,70	1	NS100-77
80 mm	727,46	1	NS100-80
82 mm	797,72	1	NS100-82
85 mm	828,87	1	NS100-85
88 mm	939,09	1	NS100-88
90 mm	847,06	1	NS100-90
94 mm	868,40	1	NS100-94
95 mm	847,06	1	NS100-95
100 mm	1.300,30	1	NS100-100
105 mm	1.581,89	1	NS100-105
110 mm	1.400,91	1	NS100-110
115 mm	1.678,68	1	NS100-115
120 mm	1.795,53	1	NS100-120



BAM/ZBF/002/21

Chave de bocas de impacto antichispa
CU-BE



NSB100

	€		
17 mm	101,02	1	NSB100-17
19 mm	105,08	1	NSB100-19
22 mm	109,12	1	NSB100-22
24 mm	117,21	1	NSB100-24
25 mm	131,33	1	NSB100-25
27 mm	131,33	1	NSB100-27
28 mm	131,33	1	NSB100-28
29 mm	161,64	1	NSB100-29
30 mm	161,64	1	NSB100-30
32 mm	163,00	1	NSB100-32
33 mm	181,86	1	NSB100-33
34 mm	181,86	1	NSB100-34
35 mm	191,95	1	NSB100-35
36 mm	191,95	1	NSB100-36
37 mm	212,16	1	NSB100-37



	€		
38 mm	212,16	1	NSB100-38
41 mm	232,37	1	NSB100-41
42 mm	267,21	1	NSB100-42
45 mm	292,98	1	NSB100-45
46 mm	292,98	1	NSB100-46
47 mm	318,22	1	NSB100-47
50 mm	343,50	1	NSB100-50
52 mm	377,84	1	NSB100-52
54 mm	394,01	1	NSB100-54
55 mm	394,01	1	NSB100-55
56 mm	409,82	1	NSB100-56
58 mm	491,47	1	NSB100-58
60 mm	496,18	1	NSB100-60
63 mm	526,40	1	NSB100-63
65 mm	541,63	1	NSB100-65
67 mm	644,79	1	NSB100-67
70 mm	712,15	1	NSB100-70
71 mm	746,07	1	NSB100-71
75 mm	801,95	1	NSB100-75
77 mm	895,31	1	NSB100-77
80 mm	945,69	1	NSB100-80
82 mm	1.037,01	1	NSB100-82
85 mm	1.077,52	1	NSB100-85
88 mm	1.220,81	1	NSB100-88
90 mm	1.364,10	1	NSB100-90
94 mm	1.398,51	1	NSB100-94
95 mm	1.433,36	1	NSB100-95
100 mm	1.552,87	1	NSB100-100
105 mm	1.835,21	1	NSB100-105
110 mm	1.976,44	1	NSB100-110
115 mm	2.368,29	1	NSB100-115
120 mm	2.533,18	1	NSB100-120



BAM/ZBF/003/21

Chave de luneta de pancada anti-chispa,
métrico



NS104

	€		
17 mm	84,08	1	NS104-17
19 mm	85,62	1	NS104-19
20 mm	86,37	1	NS104-20
22 mm	87,14	1	NS104-22
24 mm	88,68	1	NS104-24
25 mm	99,67	1	NS104-25
26 mm	99,72	1	NS104-26
27 mm	99,72	1	NS104-27
28 mm	104,62	1	NS104-28
29 mm	106,95	1	NS104-29
30 mm	111,10	1	NS104-30
31 mm	114,64	1	NS104-31
32 mm	116,54	1	NS104-32

	€		
33 mm	127,87	1	NS104-33
34 mm	135,22	1	NS104-34
35 mm	138,75	1	NS104-35
36 mm	136,00	1	NS104-36
37 mm	136,63	1	NS104-37
38 mm	142,40	1	NS104-38
39 mm	172,15	1	NS104-39
40 mm	175,39	1	NS104-40
41 mm	178,31	1	NS104-41
42 mm	193,92	1	NS104-42
43 mm	198,98	1	NS104-43
44 mm	193,92	1	NS104-44
45 mm	197,30	1	NS104-45
46 mm	202,36	1	NS104-46
47 mm	219,07	1	NS104-47
48 mm	222,88	1	NS104-48
49 mm	226,70	1	NS104-49
50 mm	230,50	1	NS104-50
51 mm	236,24	1	NS104-51
52 mm	242,04	1	NS104-52
53 mm	243,97	1	NS104-53
54 mm	245,91	1	NS104-54
55 mm	262,69	1	NS104-55
56 mm	269,82	1	NS104-56
57 mm	274,33	1	NS104-57
58 mm	278,82	1	NS104-58
59 mm	283,32	1	NS104-59
60 mm	308,67	1	NS104-60
61 mm	319,64	1	NS104-61
62 mm	326,08	1	NS104-62
63 mm	336,30	1	NS104-63
64 mm	346,47	1	NS104-64
65 mm	337,02	1	NS104-65
66 mm	327,91	1	NS104-66
67 mm	333,17	1	NS104-67
68 mm	402,24	1	NS104-68
69 mm	402,24	1	NS104-69
70 mm	380,90	1	NS104-70
71 mm	405,11	1	NS104-71
72 mm	407,99	1	NS104-72
73 mm	410,85	1	NS104-73
74 mm	413,73	1	NS104-74
75 mm	459,72	1	NS104-75
76 mm	478,15	1	NS104-76
77 mm	484,12	1	NS104-77
78 mm	498,24	1	NS104-78
79 mm	512,39	1	NS104-79
80 mm	526,53	1	NS104-80
81 mm	555,99	1	NS104-81
82 mm	562,55	1	NS104-82
83 mm	569,12	1	NS104-83
84 mm	575,68	1	NS104-84
85 mm	582,25	1	NS104-85
86 mm	644,98	1	NS104-86
87 mm	659,19	1	NS104-87
88 mm	673,39	1	NS104-88
89 mm	687,61	1	NS104-89
90 mm	647,85	1	NS104-90
92 mm	738,05	1	NS104-92
94 mm	747,26	1	NS104-94
95 mm	669,92	1	NS104-95
98 mm	794,85	1	NS104-98
100 mm	788,11	1	NS104-100
105 mm	853,79	1	NS104-105
110 mm	1.011,42	1	NS104-110
115 mm	1.011,42	1	NS104-115
120 mm	1.313,51	1	NS104-120

BAM/ZBF/002/21



Chave de luneta de impacto antichispa, métrico CU-BE



NSB104

	€		
17 mm	98,52	1	NSB104-17
19 mm	101,15	1	NSB104-19
20 mm	106,40	1	NSB104-20
22 mm	108,00	1	NSB104-22
24 mm	109,00	1	NSB104-24
25 mm	129,61	1	NSB104-25
26 mm	129,62	1	NSB104-26
27 mm	137,91	1	NSB104-27
28 mm	136,00	1	NSB104-28
29 mm	139,03	1	NSB104-29
30 mm	144,50	1	NSB104-30
31 mm	149,04	1	NSB104-31
32 mm	157,62	1	NSB104-32
33 mm	149,04	1	NSB104-33
34 mm	149,04	1	NSB104-34
35 mm	149,04	1	NSB104-35
36 mm	183,89	1	NSB104-36
37 mm	200,60	1	NSB104-37
38 mm	217,80	1	NSB104-38
39 mm	254,56	1	NSB104-39
40 mm	268,23	1	NSB104-40
41 mm	288,97	1	NSB104-41
42 mm	296,60	1	NSB104-42
43 mm	304,34	1	NSB104-43
44 mm	296,60	1	NSB104-44
45 mm	301,77	1	NSB104-45
46 mm	309,51	1	NSB104-46
47 mm	335,06	1	NSB104-47
48 mm	340,88	1	NSB104-48
49 mm	346,72	1	NSB104-49
50 mm	361,22	1	NSB104-50
51 mm	361,22	1	NSB104-51
52 mm	380,90	1	NSB104-52
53 mm	373,11	1	NSB104-53
54 mm	376,08	1	NSB104-54
55 mm	400,63	1	NSB104-55
56 mm	412,67	1	NSB104-56
57 mm	419,56	1	NSB104-57
58 mm	426,43	1	NSB104-58
59 mm	433,30	1	NSB104-59
60 mm	440,19	1	NSB104-60
61 mm	456,65	1	NSB104-61
62 mm	465,84	1	NSB104-62
63 mm	480,43	1	NSB104-63
64 mm	494,96	1	NSB104-64
65 mm	481,46	1	NSB104-65
66 mm	501,51	1	NSB104-66
67 mm	509,53	1	NSB104-67
68 mm	615,18	1	NSB104-68
69 mm	615,18	1	NSB104-69
70 mm	615,21	1	NSB104-70
71 mm	619,57	1	NSB104-71
72 mm	623,97	1	NSB104-72
73 mm	628,36	1	NSB104-73
74 mm	632,77	1	NSB104-74
75 mm	637,16	1	NSB104-75
76 mm	668,36	1	NSB104-76

	€		
77 mm	676,70	1	NSB104-77
78 mm	696,44	1	NSB104-78
79 mm	716,25	1	NSB104-79
80 mm	736,02	1	NSB104-80
81 mm	777,18	1	NSB104-81
82 mm	786,35	1	NSB104-82
83 mm	795,52	1	NSB104-83
84 mm	804,69	1	NSB104-84
85 mm	813,88	1	NSB104-85
86 mm	901,59	1	NSB104-86
87 mm	921,44	1	NSB104-87
88 mm	941,29	1	NSB104-88
89 mm	961,17	1	NSB104-89
90 mm	905,58	1	NSB104-90
92 mm	1.031,65	1	NSB104-92
94 mm	1.044,56	1	NSB104-94
95 mm	1.057,48	1	NSB104-95
98 mm	1.215,65	1	NSB104-98
100 mm	1.239,35	1	NSB104-100
105 mm	1.315,39	1	NSB104-105
110 mm	1.539,87	1	NSB104-110
115 mm	2.310,95	1	NSB104-115
120 mm	1.975,17	1	NSB104-120

BAM/ZBF/003/21

Chave de luneta de pancada anti-chispa, em polegadas



NS106

	€		
5/8 in	60,62	1	NS106-20
11/16 in	76,94	1	NS106-22
3/4 in	81,07	1	NS106-24
25/32 in	86,85	1	NS106-25
13/16 in	88,41	1	NS106-26
7/8 in	91,25	1	NS106-28
15/16 in	92,79	1	NS106-30
1 in	94,30	1	NS106-32
1 1/16 in	97,34	1	NS106-34
1 1/8 in	100,39	1	NS106-36
1 3/16 in	103,30	1	NS106-38
1 1/4 in	105,09	1	NS106-40
1 5/16 in	97,59	1	NS106-42
1 3/8 in	100,13	1	NS106-44
1 13/32 in	102,47	1	NS106-45
1 7/16 in	133,91	1	NS106-46
1 1/2 in	135,90	1	NS106-48
1 9/16 in	141,36	1	NS106-50
1 5/8 in	171,13	1	NS106-52
1 11/16 in	154,78	1	NS106-54
1 3/4 in	158,55	1	NS106-56
1 13/16 in	197,01	1	NS106-58
1 7/8 in	215,12	1	NS106-60
1 15/16 in	195,96	1	NS106-62
2 in	229,10	1	NS106-64
2 1/16 in	214,47	1	NS106-66
2 1/8 in	226,82	1	NS106-68
2 3/16 in	239,20	1	NS106-70
2 13/64 in	239,20	1	NS106-71
2 1/4 in	280,77	1	NS106-72

	€		
2 5/16 in	295,54	1	NS106-74
2 3/8 in	302,10	1	NS106-76
2 7/16 in	286,45	1	NS106-78
2 1/2 in	315,25	1	NS106-80
2 9/16 in	316,03	1	NS106-82
2 5/8 in	328,37	1	NS106-84
2 3/4 in	394,04	1	NS106-88
2 13/16 in	405,60	1	NS106-90
2 7/8 in	423,23	1	NS106-92
2 15/16 in	446,59	1	NS106-94
3 in	472,86	1	NS106-96
3 1/16 in	462,94	1	NS106-98
3 1/8 in	634,88	1	NS106-100
3 1/4 in	652,51	1	NS106-104
3 3/8 in	668,82	1	NS106-108
3 1/2 in	692,18	1	NS106-112
3 9/16 in	731,87	1	NS106-114
3 5/8 in	828,20	1	NS106-116
3 3/4 in	863,55	1	NS106-120
3 7/8 in	932,62	1	NS106-124
3 15/16 in	1.007,22	1	NS106-126
4 in	1.047,52	1	NS106-128
4 1/8 in	1.087,81	1	NS106-132
4 1/4 in	1.265,21	1	NS106-136
4 5/16 in	1.296,82	1	NS106-138
4 1/2 in	1.547,52	1	NS106-144
4 9/16 in	1.566,62	1	NS106-146
4 11/16 in	1.661,61	1	NS106-150
4 7/8 in	1.857,11	1	NS106-156
4 15/16 in	2.657,99	1	NS106-158



BAM/ZBF/002/21

Chave de luneta de impacto antichispa, em polegadas CU-BE



NSB106

	€		
5/8 in	105,08	1	NSB106-20
11/16 in	117,69	1	NSB106-22
3/4 in	123,98	1	NSB106-24
25/32 in	96,63	1	NSB106-25
13/16 in	110,69	1	NSB106-26
7/8 in	131,84	1	NSB106-28
15/16 in	134,00	1	NSB106-30
1 in	136,23	1	NSB106-32
1.1/16 in	140,62	1	NSB106-34
1.1/8 in	145,02	1	NSB106-36
1.3/16 in	149,21	1	NSB106-38
1.1/4 in	164,79	1	NSB106-40
1.5/16 in	169,16	1	NSB106-42
1.3/8 in	173,58	1	NSB106-44
1.13/32 in	219,21	1	NSB106-45
1.7/16 in	232,14	1	NSB106-46
1.1/2 in	235,58	1	NSB106-48
1.9/16 in	245,02	1	NSB106-50
1.5/8 in	261,74	1	NSB106-52
1.11/16 in	282,40	1	NSB106-54
1.3/4 in	288,97	1	NSB106-56
1.13/16 in	317,08	1	NSB106-58
1.7/8 in	354,65	1	NSB106-60

	€		
1.15/16 in	367,79	1	NSB106-62
2 in	385,99	1	NSB106-64
2.1/16 in	367,79	1	NSB106-66
2.1/8 in	380,90	1	NSB106-68
2.3/16 in	394,04	1	NSB106-70
2.13/64 in	399,00	1	NSB106-71
2.1/4 in	427,37	1	NSB106-72
2.5/16 in	427,37	1	NSB106-74
2.3/8 in	441,15	1	NSB106-76
2.7/16 in	496,46	1	NSB106-78
2.1/2 in	502,95	1	NSB106-80
2.9/16 in	483,35	1	NSB106-82
2.5/8 in	527,29	1	NSB106-84
2.3/4 in	659,12	1	NSB106-88
2.13/16 in	660,00	1	NSB106-90
2.7/8 in	732,61	1	NSB106-92
2.15/16 in	745,89	1	NSB106-94
3 in	756,56	1	NSB106-96
3.1/16 in	802,41	1	NSB106-98
3.1/8 in	825,32	1	NSB106-100
3.1/4 in	848,24	1	NSB106-104
3.3/8 in	869,44	1	NSB106-108
3.1/2 in	899,86	1	NSB106-112
3.9/16 in	951,39	1	NSB106-114
3.5/8 in	1.076,65	1	NSB106-116
3.3/4 in	1.122,59	1	NSB106-120
3.7/8 in	1.212,40	1	NSB106-124
3.15/16 in	1.309,39	1	NSB106-126
4 in	1.361,79	1	NSB106-128
4.1/8 in	1.414,18	1	NSB106-132
4.1/4 in	1.644,78	1	NSB106-136
4.5/16 in	1.685,89	1	NSB106-138
4.1/2 in	2.011,79	1	NSB106-144
4.9/16 in	2.749,44	1	NSB106-146
4.11/16 in	2.818,14	1	NSB106-150
4.7/8 in	2.826,31	1	NSB106-156
4.15/16 in	3.454,89	1	NSB106-158



BAM/ZBF/003/21

CHAVES DE BOCAS PARA TUBOS E FERRAMENTAS PARA VALVULAS

Chave para tubos anti-chispa



NS200



	L	€		
25 mm	200 mm	196,47	1	NS200-200
30 mm	250 mm	228,15	1	NS200-250
40 mm	300 mm	247,18	1	NS200-300
50 mm	350 mm	291,53	1	NS200-350
60 mm	450 mm	493,78	1	NS200-450
75 mm	600 mm	728,33	1	NS200-600
85 mm	900 mm	1.255,20	1	NS200-900
110 mm	1200 mm	1.715,14	1	NS200-1200

BAM/ZBF/002/21

Chave de tubos antichispa para resistente CU-BE



NSB200

	L	€		
25 mm	200 mm	313,17	1	NSB200-200
30 mm	250 mm	363,70	1	NSB200-250
40 mm	300 mm	394,01	1	NSB200-300
50 mm	350 mm	464,73	1	NSB200-350
60 mm	450 mm	565,76	1	NSB200-450
75 mm	600 mm	848,62	1	NSB200-600
85 mm	900 mm	1.474,99	1	NSB200-900
110 mm	1200 mm	2.687,31	1	NSB200-1200

BAM/ZBF/003/21

Chave de válvula longa anti-chispa



NS202

	€		
370 mm	255,96	1	NS202-350

BAM/ZBF/002/21

Chave de válvula longa antichispa CU-BE



NSB202



	€		
375 mm	301,93	1	NSB202-350





BAM/ZBF/003/21

Chave de válvula antichispa AL-BR



NS203

		€		
215 mm	24 mm	85,70	1	NS203-200
215 mm	32 mm	128,48	1	NS203-215





		€		
290 mm	36 mm	139,82	1	NS203-290
400 mm	48 mm	183,74	1	NS203-400
490 mm	60 mm	273,19	1	NS203-490
800 mm	60 mm	647,86	1	NS203-800

BAM/ZBF/002/21

Chave de válvula antichispa CU-BE



NSB203



		€		
215 mm	24 mm	128,27	1	NSB203-200
215 mm	32 mm	183,54	1	NSB203-215
290 mm	36 mm	213,58	1	NSB203-290
400 mm	48 mm	262,48	1	NSB203-400
490 mm	60 mm	390,23	1	NSB203-490
800 mm	60 mm	925,54	1	NSB203-800

BAM/ZBF/003/21

Gancho de válvula anti-chispa



NS204

	€		
200 mm	149,30	1	NS204-30
300 mm	203,18	1	NS204-32
250 mm	168,20	1	NS204-35
300 mm	203,18	1	NS204-40
350 mm	223,95	1	NS204-45
375 mm	246,63	1	NS204-48
400 mm	260,79	1	NS204-50
450 mm	271,19	1	NS204-55
500 mm	289,15	1	NS204-60
550 mm	324,12	1	NS204-65
600 mm	362,86	1	NS204-70
650 mm	405,39	1	NS204-75
700 mm	463,03	1	NS204-80
750 mm	521,61	1	NS204-85
800 mm	548,08	1	NS204-90

BAM/ZBF/002/21



Gancho de válvula antichispa CU-BE



NSB204

L	€		
200 mm	234,36	1	NSB204-30
300 mm	322,21	1	NSB204-32
250 mm	260,79	1	NSB204-35
300 mm	322,21	1	NSB204-40
350 mm	393,10	1	NSB204-45
375 mm	426,18	1	NSB204-48
400 mm	452,63	1	NSB204-50
450 mm	540,50	1	NSB204-55
500 mm	582,10	1	NSB204-60
550 mm	663,35	1	NSB204-65
600 mm	728,56	1	NSB204-70
650 mm	810,77	1	NSB204-75
700 mm	922,28	1	NSB204-80
750 mm	1.026,22	1	NSB204-85
800 mm	1.132,05	1	NSB204-90

BAM/ZBF/003/21

CHAVES DE CAIXA E ROQUETES

Chaves de caixa antichispa de 1/2" AL-BR



NS220

Ø	L	€		
6 mm	40 mm	63,35	1	NS220-06
7 mm	40 mm	64,94	1	NS220-07
8 mm	40 mm	66,52	1	NS220-08
9 mm	40 mm	68,10	1	NS220-09
10 mm	40 mm	69,70	1	NS220-10
11 mm	40 mm	71,26	1	NS220-11
12 mm	40 mm	72,86	1	NS220-12
13 mm	40 mm	74,45	1	NS220-13
14 mm	40 mm	76,04	1	NS220-14
15 mm	40 mm	77,61	1	NS220-15
16 mm	40 mm	79,20	1	NS220-16

Ø	L	€		
17 mm	40 mm	85,53	1	NS220-17
18 mm	42 mm	87,10	1	NS220-18
19 mm	42 mm	88,69	1	NS220-19
20 mm	42 mm	90,28	1	NS220-20
21 mm	43 mm	95,04	1	NS220-21
22 mm	43 mm	98,20	1	NS220-22
23 mm	43 mm	101,37	1	NS220-23
24 mm	43 mm	107,69	1	NS220-24
25 mm	43 mm	110,87	1	NS220-25
26 mm	43 mm	118,79	1	NS220-26
27 mm	46 mm	123,55	1	NS220-27
28 mm	46 mm	126,71	1	NS220-28
29 mm	46 mm	138,24	1	NS220-29
30 mm	46 mm	139,38	1	NS220-30
32 mm	46 mm	142,55	1	NS220-32
34 mm	50 mm	123,41	1	NS220-34
36 mm	50 mm	135,75	1	NS220-36
41 mm	55 mm	164,99	1	NS220-41

BAM/ZBF/002/21

Chaves de caixa antichispa de 1/2" CU-BE



NSB220

Ø	L	€		
6 mm	40 mm	71,65	1	NSB220-06
7 mm	40 mm	73,43	1	NSB220-07
8 mm	40 mm	75,23	1	NSB220-08
9 mm	40 mm	77,03	1	NSB220-09
10 mm	40 mm	71,40	1	NSB220-10
11 mm	40 mm	75,09	1	NSB220-11
12 mm	40 mm	80,01	1	NSB220-12
13 mm	41 mm	83,71	1	NSB220-13
14 mm	40 mm	84,93	1	NSB220-14
15 mm	40 mm	87,40	1	NSB220-15
16 mm	40 mm	90,47	1	NSB220-16
17 mm	41 mm	92,94	1	NSB220-17
18 mm	42 mm	96,01	1	NSB220-18
19 mm	42 mm	100,33	1	NSB220-19
20 mm	42 mm	101,56	1	NSB220-20
21 mm	43 mm	104,62	1	NSB220-21
22 mm	43 mm	108,32	1	NSB220-22
23 mm	44 mm	114,64	1	NSB220-23
24 mm	43 mm	121,80	1	NSB220-24
25 mm	44 mm	136,63	1	NSB220-25
26 mm	43 mm	146,49	1	NSB220-26
27 mm	47 mm	153,87	1	NSB220-27
28 mm	46 mm	162,49	1	NSB220-28
29 mm	47 mm	175,04	1	NSB220-29
30 mm	46 mm	180,95	1	NSB220-30
32 mm	47 mm	198,80	1	NSB220-32

BAM/ZBF/003/21

Chaves de caixa antichispa de 3/4" AL-BR



NS224

Ø	L	€		
17 mm	50 mm	86,88	1	NS224-17
18 mm	50 mm	87,15	1	NS224-18
19 mm	50 mm	87,42	1	NS224-19
21 mm	55 mm	96,15	1	NS224-21
22 mm	55 mm	97,18	1	NS224-22
23 mm	55 mm	102,66	1	NS224-23
24 mm	55 mm	128,85	1	NS224-24
26 mm	55 mm	130,21	1	NS224-26
27 mm	55 mm	138,14	1	NS224-27
28 mm	55 mm	145,04	1	NS224-28
29 mm	55 mm	155,09	1	NS224-29
30 mm	60 mm	163,55	1	NS224-30
32 mm	60 mm	184,72	1	NS224-32
34 mm	60 mm	199,55	1	NS224-34
36 mm	60 mm	212,77	1	NS224-36
38 mm	60 mm	227,60	1	NS224-38
41 mm	65 mm	250,89	1	NS224-41
46 mm	65 mm	296,39	1	NS224-46
50 mm	70 mm	324,99	1	NS224-50

BAM/ZBF/002/21

Chaves de caixa antichispa de 3/4" CU-BE



NSB224

Ø	L	€		
17 mm	50 mm	119,72	1	NSB224-17
18 mm	50 mm	147,70	1	NSB224-18
19 mm	50 mm	120,26	1	NSB224-19
21 mm	55 mm	132,43	1	NSB224-21
22 mm	55 mm	135,60	1	NSB224-22
23 mm	55 mm	169,54	1	NSB224-23
24 mm	56 mm	152,26	1	NSB224-24
26 mm	55 mm	158,43	1	NSB224-26
27 mm	55 mm	161,21	1	NSB224-27
28 mm	55 mm	171,08	1	NSB224-28
29 mm	55 mm	207,28	1	NSB224-29
30 mm	60 mm	219,84	1	NSB224-30
32 mm	61 mm	247,84	1	NSB224-32
34 mm	60 mm	266,69	1	NSB224-34
36 mm	61 mm	286,50	1	NSB224-36
38 mm	60 mm	305,84	1	NSB224-38
41 mm	66 mm	336,26	1	NSB224-41

Ø	L	€	📦	🐟
46 mm	65 mm	397,62	1	NSB224-46
50 mm	71 mm	435,79	1	NSB224-50

BAM/ZBF/003/21

Chaves de caixa antichispa de 1" AL-BR



NS228

Ø	L	€	📦	🐟
22 mm	55 mm	127,64	1	NS228-22
24 mm	55 mm	140,95	1	NS228-24
26 mm	55 mm	174,22	1	NS228-26
27 mm	55 mm	180,25	1	NS228-27
28 mm	55 mm	183,89	1	NS228-28
29 mm	55 mm	188,13	1	NS228-29
30 mm	60 mm	192,35	1	NS228-30
31 mm	60 mm	208,09	1	NS228-31
32 mm	60 mm	222,60	1	NS228-32
34 mm	60 mm	234,71	1	NS228-34
36 mm	65 mm	251,65	1	NS228-36
38 mm	65 mm	270,99	1	NS228-38
41 mm	70 mm	307,89	1	NS228-41
46 mm	75 mm	342,38	1	NS228-46
50 mm	75 mm	376,25	1	NS228-50
55 mm	80 mm	424,64	1	NS228-55
60 mm	85 mm	474,24	1	NS228-60
65 mm	90 mm	526,26	1	NS228-65
70 mm	90 mm	579,50	1	NS228-70
75 mm	95 mm	632,73	1	NS228-75
80 mm	95 mm	687,78	1	NS228-80

BAM/ZBF/002/21

Chaves de caixa antichispa de 1" CU-BE



NSB228

Ø	g	€	📦	🐟
22 mm	370 g	170,16	1	NSB228-22
24 mm	430 g	197,02	1	NSB228-24
26 mm	396 g	214,94	1	NSB228-26
27 mm	440 g	232,86	1	NSB228-27
28 mm	411 g	229,87	1	NSB228-28

Ø	g	€	📦	🐟
29 mm	460 g	268,66	1	NSB228-29
30 mm	462 g	286,57	1	NSB228-30
31 mm	520 g	270,15	1	NSB228-31
32 mm	497 g	302,70	1	NSB228-32
34 mm	506 g	358,22	1	NSB228-34
36 mm	610 g	376,13	1	NSB228-36
38 mm	600 g	394,04	1	NSB228-38
41 mm	740 g	403,00	1	NSB228-41
46 mm	832 g	438,83	1	NSB228-46
50 mm	960 g	465,66	1	NSB228-50
55 mm	1130 g	510,48	1	NSB228-55
60 mm	1570 g	635,85	1	NSB228-60
65 mm	1698 g	680,62	1	NSB228-65
70 mm	2350 g	752,27	1	NSB228-70
75 mm	3010 g	893,77	1	NSB228-75
80 mm	2818 g	949,28	1	NSB228-80

BAM/ZBF/003/21

Adaptadores antichispa AL-BR



NS232

Ø	Ø	€	📦	🐟
1/2"	3/4"	124,02	1	NS232-16-24
3/4"	1/2"	151,27	1	NS232-24-16
3/4"	1"	253,04	1	NS232-24-32
1"	3/4"	245,70	1	NS232-32-24

BAM/ZBF/002/21

Adaptadores antichispa CU-BE



NSB232

Ø	Ø	€	📦	🐟
1/2"	3/4"	176,83	1	NSB232-16-24
3/4"	1/2"	213,47	1	NSB232-24-16
3/4"	1"	359,63	1	NSB232-24-32
1"	3/4"	348,10	1	NSB232-32-24

BAM/ZBF/003/21

Extensões antichispa AL-BR



NS234

Ø	Ø	€	📦	🐟
1/2"	1/2"	120,26	1	NS234-16-100
1/2"	1/2"	132,06	1	NS234-16-200
1/2"	1/2"	145,04	1	NS234-16-250
3/4"	3/4"	198,07	1	NS234-24-200
1"	1"	341,94	1	NS234-32-250

BAM/ZBF/002/21

Extensões antichispa CU-BE



NSB234

L	Ø	€	📦	🐟
100 mm	16.4 mm	150,97	1	NSB234-16-100
200 mm	16.4 mm	167,22	1	NSB234-16-200
250 mm	16.4 mm	162,58	1	NSB234-16-250
200 mm	25 mm	234,57	1	NSB234-24-200
250 mm	34 mm	488,50	1	NSB234-32-250

BAM/ZBF/003/21

Cardans universais antichispa AL-BR



NS236

Ø	Ø	€	📦	🐟
1/2"	1/2"	146,99	1	NS236-16
3/4"	3/4"	354,77	1	NS236-24
1"	1"	484,52	1	NS236-32

BAM/ZBF/002/21



Cardans universais antichispa CU-BE



NSB236

1/2"	3/4"	1"	€	1	NSB236-16
1/2"	3/4"	1"	224,16	1	NSB236-16
3/4"	1"		464,51	1	NSB236-24
1"			707,32	1	NSB236-32

BAM/ZBF/003/21

Extensão offset antichispa AL-BR



NS240

1/2"	230 mm	€	1	NS240-16-230
1/2"	230 mm	189,92	1	NS240-16-230

BAM/ZBF/002/21

Roquetes antichispa CU-BE



NSB242

1/2"	245 mm	€	1	NSB242-16
1/2"	245 mm	255,48	1	NSB242-16
3/4"	320 mm	510,96	1	NSB242-24
1"	550 mm	1.068,36	1	NSB242-32

BAM/ZBF/003/21

Barra em T deslizante antichispa AL-BR



NS238

1/2"	250 mm	€	1	NS238-16-250
1/2"	250 mm	206,35	1	NS238-16-250
3/4"	260 mm	409,14	1	NS238-24-250
1"	300 mm	514,09	1	NS238-32-300

BAM/ZBF/002/21

Extensão offset antichispa CU-BE



NSB240

1/2"	370 g	€	1	NSB240-16-230
1/2"	370 g	219,21	1	NSB240-16-230

BAM/ZBF/003/21

Alavancas rotativas antichispa AL-BR



NS243

1/2"	390 mm	€	1	NS243-16-400
1/2"	390 mm	241,91	1	NS243-16-400

BAM/ZBF/002/21

Barra em T deslizante antichispa CU-BE



NSB238

1/2"	250 mm	€	1	NSB238-16-250
1/2"	250 mm	174,18	1	NSB238-16-250
3/4"	250 mm	267,09	1	NSB238-24-250
1"	300 mm	487,74	1	NSB238-32-300

BAM/ZBF/003/21

Roquetes antichispa AL-BR



NS242

1/2"	245 mm	€	1	NS242-16
1/2"	245 mm	308,92	1	NS242-16
3/4"	320 mm	496,40	1	NS242-24
1"	550 mm	962,92	1	NS242-32

BAM/ZBF/002/21

Alavancas rotativas antichispa CU-BE



NSB243

1/2"	395 mm	€	1	NSB243-16-400
1/2"	395 mm	339,22	1	NSB243-16-400

BAM/ZBF/003/21

Chaves de velas de ignição antichispa AL-BR



NS247

		€		
1/2"	13 mm	146,32	1	NS247-26

BAM/ZBF/002/21

Chaves de velas de ignição antichispa CU-BE



NSB247

		€		
1/2"	13 mm	220,64	1	NSB247-26

BAM/ZBF/003/21

Chaves caixa p/chave de parafusos antichispa AL-BR



NS248

	€		
13 mm	78,33	1	NS248-16-52

BAM/ZBF/002/21

Chaves caixa p/chave de parafusos antichispa CU-BE



NSB248

	€		
13 mm	110,66	1	NSB248-16-52

BAM/ZBF/003/21

CHAVES DE PARAFUSOS

Chave de parafusos de fenda ERGO™ antichispa AL-BR



NS300

		€		
3 mm	50 mm	16,94	1	NS300-3-50
3 mm	75 mm	19,76	1	NS300-3-75
4 mm	75 mm	21,18	1	NS300-4-75
4.5 mm	50 mm	18,36	1	NS300-4.5-50
4.5 mm	100 mm	25,67	1	NS300-4.5-100
5 mm	75 mm	22,59	1	NS300-5-75
5 mm	100 mm	25,40	1	NS300-5-100
6 mm	100 mm	26,83	1	NS300-6-100
6 mm	125 mm	30,39	1	NS300-6-125
6 mm	150 mm	33,57	1	NS300-6-150
7 mm	150 mm	38,00	1	NS300-7-150
8 mm	150 mm	41,34	1	NS300-8-150
8 mm	200 mm	49,43	1	NS300-8-200
9 mm	250 mm	56,48	1	NS300-9-250
10 mm	200 mm	71,51	1	NS300-10-200
10 mm	300 mm	93,25	1	NS300-10-300
11 mm	250 mm	85,48	1	NS300-11-250
11 mm	300 mm	101,02	1	NS300-11-300
11 mm	350 mm	116,56	1	NS300-11-350
12 mm	400 mm	122,78	1	NS300-12-400
13 mm	450 mm	132,11	1	NS300-13-450

BAM/ZBF/002/21

Chave de parafusos entalhados ERGO™ anti-chispa



NSB300

		€		
3 mm	50 mm	21,00	1	NSB300-3-50
3 mm	75 mm	21,18	1	NSB300-3-75
4 mm	75 mm	26,83	1	NSB300-4-75
4.5 mm	60 mm	23,99	1	NSB300-4.5-50
4.5 mm	95 mm	27,73	1	NSB300-4.5-100
5 mm	75 mm	29,46	1	NSB300-5-75
5 mm	100 mm	28,24	1	NSB300-5-100
6 mm	105 mm	33,89	1	NSB300-6-100
6 mm	125 mm	33,89	1	NSB300-6-125
6 mm	160 mm	41,22	1	NSB300-6-150
7 mm	150 mm	41,22	1	NSB300-7-150
8 mm	150 mm	42,36	1	NSB300-8-150
8 mm	200 mm	65,25	1	NSB300-8-200
9 mm	250 mm	77,29	1	NSB300-9-250
9 mm	200 mm	91,76	1	NSB300-10-200
10 mm	318 mm	98,82	1	NSB300-10-300
11 mm	250 mm	105,88	1	NSB300-11-250
11 mm	300 mm	112,93	1	NSB300-11-300
11 mm	350 mm	141,17	1	NSB300-11-350
12 mm	400 mm	169,41	1	NSB300-12-400
13 mm	450 mm	197,64	1	NSB300-13-450

BAM/ZBF/003/21

Chave de parafusos de electricista antichispa AL-BR



NS301

		€		
3 mm	50 mm	21,18	1	NS301-3-50
4 mm	100 mm	26,83	1	NS301-4-100
4 mm	150 mm	44,77	1	NS301-4-150
5 mm	100 mm	41,86	1	NS301-5-100
5 mm	200 mm	44,86	1	NS301-5-200
6 mm	100 mm	44,99	1	NS301-6-100
8 mm	150 mm	60,91	1	NS301-8-150
10 mm	200 mm	76,18	1	NS301-10-200
10 mm	300 mm	90,55	1	NS301-10-300

BAM/ZBF/002/21



Chave de parafusos de electricista antichispa CU-BE



ergo



NSB301

Ø	L	€		
3 mm	50 mm	30,83	1	NSB301-3-50
4 mm	100 mm	40,19	1	NSB301-4-100
4 mm	150 mm	52,92	1	NSB301-4-150
5 mm	100 mm	49,27	1	NSB301-5-100
5 mm	210 mm	70,60	1	NSB301-5-200
6 mm	100 mm	70,60	1	NSB301-6-100
8 mm	155 mm	84,70	1	NSB301-8-150
10 mm	200 mm	81,27	1	NSB301-10-200
10 mm	300 mm	100,13	1	NSB301-10-300

BAM/ZBF/003/21

Chave de parafusos ERGO™ Phillips® antichispa AL-BR



ergo



NS302

Ø	L	€		
PH0	50 mm	23,99	1	NS302-0-50
PH1	100 mm	23,99	1	NS302-1-100
PH2	125 mm	30,57	1	NS302-2-125
PH3	150 mm	42,36	1	NS302-3-150
PH4	300 mm	67,77	1	NS302-4-300

BAM/ZBF/002/21

Chave de parafusos ERGO™ Phillips® anti-chispa



ergo



NSB302

Ø	L	€		
PH0	65 mm	31,06	1	NSB302-0-50
PH1	120 mm	31,06	1	NSB302-1-100
PH2	125 mm	33,89	1	NSB302-2-125
PH3	150 mm	49,43	1	NSB302-3-150
PH4	300 mm	77,66	1	NSB302-4-300

BAM/ZBF/003/21

Chave de parafusos ERGO™ Pozidriv® antichispa AL-BR



ergo



NS304

Ø	L	€		
PZ0	50 mm	23,99	1	NS304-0-50
PZ1	100 mm	23,99	1	NS304-1-100
PZ2	125 mm	28,24	1	NS304-2-125
PZ3	150 mm	42,36	1	NS304-3-150
PZ4	300 mm	67,77	1	NS304-4-300

BAM/ZBF/002/21

Chave de parafusos ERGO™ Pozidriv® anti-chispa



ergo



NSB304

Ø	L	€		
PZ0	50 mm	31,06	1	NSB304-0-50
PZ1	100 mm	31,06	1	NSB304-1-100
PZ2	125 mm	33,89	1	NSB304-2-125
PZ3	150 mm	42,36	1	NSB304-3-150
PZ4	300 mm	77,66	1	NSB304-4-300

BAM/ZBF/003/21

Chave offset antichispa AL-BR



NS320

Ø	L	€		
2 mm	59 mm	30,75	1	NS320-2
3 mm	59 mm	31,12	1	NS320-3
4 mm	65 mm	31,61	1	NS320-4
5 mm	79 mm	32,98	1	NS320-5
6 mm	85 mm	34,39	1	NS320-6
7 mm	88 mm	38,08	1	NS320-7
8 mm	92 mm	39,95	1	NS320-8
9 mm	99 mm	44,15	1	NS320-9
10 mm	110 mm	47,41	1	NS320-10

BAM/ZBF/002/21

Chave offset antichispa CU-BE



NSB320

Ø	L	€		
2 mm	59 mm	43,91	1	NSB320-2
3 mm	59 mm	44,44	1	NSB320-3
4 mm	65 mm	45,14	1	NSB320-4
5 mm	79 mm	47,10	1	NSB320-5
6 mm	85 mm	49,12	1	NSB320-6
7 mm	88 mm	54,38	1	NSB320-7
8 mm	93 mm	57,07	1	NSB320-8
9 mm	97 mm	63,04	1	NSB320-9
10 mm	110 mm	67,68	1	NSB320-10

BAM/ZBF/003/21

ALICATES

Alicate universal antichispa AL-BR



NS400

L	€		
155 mm	127,05	1	NS400-160
175 mm	141,17	1	NS400-180
200 mm	155,30	1	NS400-200

BAM/ZBF/002/21

Alicate combinado anti-chispa



NSB400

L	€		
157 mm	169,41	1	NSB400-160
175 mm	183,53	1	NSB400-180
200 mm	197,64	1	NSB400-200

BAM/ZBF/003/21

Alicate de corte diagonal antichispa AL-BR

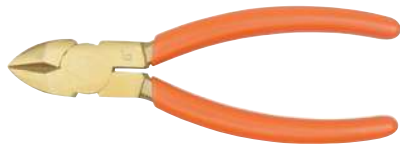

NS402

L	€	Icon 1	Icon 2
150 mm	165,00	1	NS402-160
200 mm	169,41	1	NS402-200

BAM/ZBF/002/21

Talhadeira de corte diagonal anti-chispa



NSB402

L	€	Icon 1	Icon 2
155 mm	206,09	1	NSB402-160
200 mm	253,86	1	NSB402-200

BAM/ZBF/003/21

Alicate de corte diagonal antichispa resistente AL-BR



NS403

L	€	Icon 1	Icon 2
150 mm	155,30	1	NS403-160
180 mm	169,41	1	NS403-180

BAM/ZBF/002/21

Alicate de corte diagonal antichispa resistente CU-BE



NSB403

L	€	Icon 1	Icon 2
155 mm	249,90	1	NSB403-160
180 mm	262,67	1	NSB403-180

BAM/ZBF/003/21

Alicate de pontas chatas antichispa AL-BR



NS404

L	€	Icon 1	Icon 2
150 mm	119,99	1	NS404-160

BAM/ZBF/002/21

Alicate de pontas chatas antichispa CU-BE



NSB404

L	€	Icon 1	Icon 2
155 mm	155,30	1	NSB404-160

BAM/ZBF/003/21

Alicate de pontas redondas antichispa AL-BR



NS405

L	€	Icon 1	Icon 2
160 mm	119,99	1	NS405-160

BAM/ZBF/002/21

Alicate de pontas redondas antichispa CU-BE



NSB405

L	€	Icon 1	Icon 2
155 mm	270,97	1	NSB405-160

BAM/ZBF/003/21

Alicate de pontas antichispa AL-BR



NS406

L	€	Icon 1	Icon 2
160 mm	127,05	1	NS406-160
180 mm	152,13	1	NS406-180
200 mm	152,88	1	NS406-200

BAM/ZBF/002/21

Alicate de pontas anti-chispa



NSB406

L	€	Icon 1	Icon 2
155 mm	169,41	1	NSB406-160
180 mm	197,20	1	NSB406-180
200 mm	197,64	1	NSB406-200

BAM/ZBF/003/21

Alicate de descarnar antichispa AL-BR



NS407

L	€	Icon 1	Icon 2
170 mm	276,95	1	NS407-160

BAM/ZBF/002/21



Alicate de descarnar antichispa CU-BE

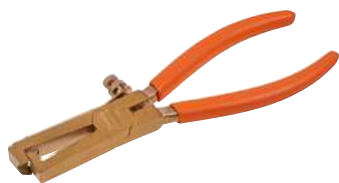

NSB407

L	€		
170 mm	372,09	1	NSB407-160

BAM/ZBF/003/21

Alicate extensível antichispa AL-BR



NS408

L	€		
260 mm	191,24	1	NS408-250
300 mm	231,59	1	NS408-300

BAM/ZBF/002/21

Alicate universal anti-chispa



NSB408

L	€		
255 mm	248,61	1	NSB408-250
300 mm	301,06	1	NSB408-300

BAM/ZBF/003/21

Alicate de bomba de água antichispa AL-BR



NS412

L	€		
200 mm	112,93	1	NS412-200

BAM/ZBF/002/21

Alicate de bomba de água antichispa CU-BE



NSB412

L	€		
200 mm	141,17	1	NSB412-200

BAM/ZBF/003/21

Alicate de tubos antichispa AL-BR



NS411

L	€		
200 mm	183,53	1	NS411-200

BAM/ZBF/002/21

Alicate de tubos antichispa CU-BE



NSB411

L	€		
205 mm	363,70	1	NSB411-200

BAM/ZBF/003/21

Tenaz de carpinteiro antichispa AL-BR



NS413

L	€		
180 mm	286,08	1	NS413-180
195 mm	286,08	1	NS413-200

BAM/ZBF/002/21

Tenaz de carpinteiro antichispa CU-BE



NSB413

L	€		
185 mm	371,90	1	NSB413-180
195 mm	371,90	1	NSB413-200

BAM/ZBF/003/21

MARTELOS, PÉS DE CABRA E FORMÕES

Marreta quadrada tipo alemão anti chispa, com cabo em nogueira



NS500

	€		
2000 g	271,58	1	NS500-2000
2500 g	339,38	1	NS500-2500
3000 g	407,18	1	NS500-3000
4000 g	539,76	1	NS500-4000

BAM/ZBF/002/21

Marreta quadrada tipo alemão antichispa, cabo nogueira CU-BE



NSB500

	€		
2000 g	325,15	1	NSB500-2000
2500 g	383,22	1	NSB500-2500
3000 g	452,90	1	NSB500-3000
4000 g	454,59	1	NSB500-4000

BAM/ZBF/003/21

Marreta quadrada tipo alemão anti chispa, com cabo em fibra de vidro



NS500-FB

	€		
1000 g	155,44	1	NS500-1000-FB
1500 g	179,24	1	NS500-1500-FB
2000 g	219,47	1	NS500-2000-FB
2500 g	275,28	1	NS500-2500-FB
3000 g	310,59	1	NS500-3000-FB
3500 g	438,92	1	NS500-3500-FB

BAM/ZBF/002/21

Marreta quadrada tipo alemão antichispa, cabo fibra vidro CU-BE



NSB500-FB

	€		
1000 g	171,74	1	NSB500-1000-FB
1500 g	247,52	1	NSB500-1500-FB
2000 g	327,33	1	NSB500-2000-FB
2500 g	420,27	1	NSB500-2500-FB
3000 g	499,08	1	NSB500-3000-FB
3500 g	630,40	1	NSB500-3500-FB

BAM/ZBF/003/21

Marreta anti-chispa, com cabo em fibra de vidro



NS502-FB

	€		
450 g	88,33	1	NS502-450-FB
1000 g	118,81	1	NS502-1000-FB
1500 g	157,62	1	NS502-1500-FB
2000 g	192,19	1	NS502-2000-FB
2500 g	244,61	1	NS502-2500-FB

	€		
3000 g	297,02	1	NS502-3000-FB
4500 g	354,65	1	NS502-4500-FB
5000 g	420,32	1	NS502-5000-FB
6800 g	551,68	1	NS502-6800-FB
8000 g	660,00	1	NS502-8000-FB
10000 g	919,47	1	NS502-10000-FB
12000 g	1.050,82	1	NS502-12000-FB

BAM/ZBF/002/21

Marreta antichispa com cabo em fibra de vidro CU-BE



NSB502-FB

	€		
450 g	117,78	1	NSB502-450-FB
1000 g	164,44	1	NSB502-1000-FB
1500 g	219,25	1	NSB502-1500-FB
2000 g	301,48	1	NSB502-2000-FB
2500 g	383,69	1	NSB502-2500-FB
3000 g	465,91	1	NSB502-3000-FB
4500 g	616,65	1	NSB502-4500-FB
5000 g	671,46	1	NSB502-5000-FB
6800 g	931,82	1	NSB502-6800-FB
8000 g	986,63	1	NSB502-8000-FB
10000 g	1.444,87	1	NSB502-10000-FB
12000 g	1.971,63	1	NSB502-12000-FB

BAM/ZBF/003/21

Martelo com cabo em fibra de vidro anti-chispa



NS504-FB

	€		
100 g	56,48	1	NS504-100-FB
200 g	60,00	1	NS504-200-FB
300 g	64,94	1	NS504-300-FB
500 g	88,94	1	NS504-500-FB
800 g	117,16	1	NS504-800-FB
1000 g	155,44	1	NS504-1000-FB
1500 g	183,53	1	NS504-1500-FB
2000 g	225,87	1	NS504-2000-FB

BAM/ZBF/002/21

Martelo de bola antichispa com cabo em fibra de vidro CU-BE



NSB504-FB

	€		
100 g	63,53	1	NSB504-100-FB
200 g	86,40	1	NSB504-200-FB
300 g	106,14	1	NSB504-300-FB
500 g	133,32	1	NSB504-500-FB
800 g	172,82	1	NSB504-800-FB
1000 g	209,85	1	NSB504-1000-FB
1500 g	283,93	1	NSB504-1500-FB
2000 g	343,18	1	NSB504-2000-FB

BAM/ZBF/003/21

Martelo de bola anti chispa com cabo em nogueira



NS506

	€		
340 g	54,86	1	NS506-300
450 g	73,15	1	NS506-450
670 g	102,88	1	NS506-700
910 g	137,15	1	NS506-900

BAM/ZBF/002/21

Martelo de bola antichispa com cabo em nogueira CU-BE



NSB506

	€		
300 g	74,08	1	NSB506-300
450 g	98,75	1	NSB506-450
680 g	138,88	1	NSB506-700
910 g	185,15	1	NSB506-900

BAM/ZBF/003/21



Martelo de bola anti chispa, com cabo em fibra de vidro



NS506-FB

	€		
310 g	55,70	1	NS506-300-FB
470 g	74,26	1	NS506-450-FB
700 g	94,06	1	NS506-700-FB
910 g	143,13	1	NS506-900-FB

BAM/ZBF/002/21

Martelo de bola antichispa com cabo em fibra de vidro CU-BE



NSB506-FB

	€		
300 g	75,50	1	NSB506-300-FB
450 g	100,65	1	NSB506-450-FB
680 g	126,98	1	NSB506-700-FB
900 g	193,22	1	NSB506-900-FB

BAM/ZBF/003/21

Martelo de orelhas antichispa AL-BR



NS508-FB

	€		
500 g	88,75	1	NS508-500-FB
700 g	104,88	1	NS508-700-FB

BAM/ZBF/002/21

Martelo de orelhas antichispa CU-BE



NSB508-FB

	€		
500 g	111,13	1	NSB508-500-FB
700 g	131,33	1	NSB508-700-FB

BAM/ZBF/003/21

Martelo-burilador antichispa AL-BR



NS512-FB

	€		
230 g	75,83	1	NS512-200-FB
400 g	95,20	1	NS512-400-FB
640 g	104,88	1	NS512-600-FB
970 g	127,46	1	NS512-900-FB

BAM/ZBF/002/21

Martelo-burilador antichispa CU-BE



NSB512-FB

	€		
200 g	94,97	1	NSB512-200-FB
400 g	119,20	1	NSB512-400-FB
600 g	131,33	1	NSB512-600-FB
900 g	185,81	1	NSB512-900-FB

BAM/ZBF/003/21

Calços anti-chispa



NS600

L	€		
80 mm	9,87	1	NS600-80-13
100 mm	36,57	1	NS600-100-50
135 mm	69,50	1	NS600-135-50
150 mm	32,92	1	NS600-150-25
150 mm	29,28	1	NS600-150-30
150 mm	36,57	1	NS600-150-40
150 mm	62,18	1	NS600-150-50
180 mm	29,28	1	NS600-180-13
180 mm	42,06	1	NS600-180-32
180 mm	93,27	1	NS600-180-50
200 mm	82,30	1	NS600-200-20
200 mm	100,58	1	NS600-200-30
200 mm	147,65	1	NS600-200-40
200 mm	72,46	1	NS600-200-50
230 mm	106,08	1	NS600-230-40
250 mm	164,59	1	NS600-250-40
300 mm	321,88	1	NS600-300-50

BAM/ZBF/002/21

Calço antichispa CU-BE



NSB600

L	€		
80 mm	13,34	1	NSB600-80-13
100 mm	49,38	1	NSB600-100-50
135 mm	93,82	1	NSB600-135-50
150 mm	44,45	1	NSB600-150-25
150 mm	47,27	1	NSB600-150-30
150 mm	51,09	1	NSB600-150-40
150 mm	83,95	1	NSB600-150-50
180 mm	38,11	1	NSB600-180-13
180 mm	56,78	1	NSB600-180-32
180 mm	125,92	1	NSB600-180-50
200 mm	111,11	1	NSB600-200-20
200 mm	135,79	1	NSB600-200-30
200 mm	211,26	1	NSB600-200-40
200 mm	99,02	1	NSB600-200-50
230 mm	143,20	1	NSB600-230-40
250 mm	222,20	1	NSB600-250-40
300 mm	434,54	1	NSB600-300-50

BAM/ZBF/003/21

Pé-de-cabra anti-chispa



NS602

Ø	L	€		
16 mm	460 mm	148,04	1	NS602-460
20 mm	600 mm	203,95	1	NS602-600
22 mm	760 mm	313,26	1	NS602-760
22 mm	935 mm	364,01	1	NS602-900

BAM/ZBF/002/21

Talheadeira de corte cruzado antichispa CU-BE



NSB604

L	€		
140 mm	128,70	1	NSB604-150
200 mm	172,62	1	NSB604-200
300 mm	343,17	1	NSB604-300

BAM/ZBF/003/21

Punção de centro anti-chispa



NS608

L	€		
100 mm	33,84	1	NS608-100

BAM/ZBF/002/21

Pé-de-cabra antichispa CU-BE



NSB6028

Ø	L	€		
16 mm	460 mm	299,78	1	NSB602-460
20 mm	600 mm	136,94	1	NSB602-600
22 mm	760 mm	621,79	1	NSB602-760
22 mm	920 mm	737,13	1	NSB602-900

BAM/ZBF/003/21

Talheadeira chata anti-chispa



NS606

L	€		
150 mm	55,26	1	NS606-150
200 mm	71,05	1	NS606-200
250 mm	96,05	1	NS606-250
300 mm	114,45	1	NS606-300
400 mm	147,37	1	NS606-400

BAM/ZBF/002/21

Punção de centro antichispa CU-BE



NSB608

L	€		
100 mm	68,61	1	NSB608-100

BAM/ZBF/003/21

Talheadeira de corte cruzado anti-chispa



NS604

L	€		
140 mm	101,08	1	NS604-150
200 mm	162,15	1	NS604-200
300 mm	265,23	1	NS604-300

BAM/ZBF/002/21

Talheadeira chata antichispa CU-BE



NSB606

L	€		
150 mm	87,03	1	NSB606-150
200 mm	111,91	1	NSB606-200
250 mm	151,28	1	NSB606-250
300 mm	205,17	1	NSB606-300
400 mm	264,11	1	NSB606-400

BAM/ZBF/003/21

RASPADORES

Raspador angular antichispa AL-BR



NS700

L	€		
45 mm	63,47	1	NS700-300

BAM/ZBF/002/21



Raspador angular anti-chispa



NSB700

		€		
45 mm	310 mm	175,31	1	NSB700-300

BAM/ZBF/003/21

Raspador de lâmina longa antichispa AL-BR



NS704

		€		
100 mm	720 mm	120,63	1	NS704-225

BAM/ZBF/002/21

Raspador flexível anti-chispa



NSB706

		€		
50 mm	200 mm	120,18	1	NSB706-50
80 mm	200 mm	184,41	1	NSB706-80

BAM/ZBF/003/21

Raspador plano antichispa AL-BR



NS702

		€		
30 mm	325 mm	54,20	1	NS702-200

BAM/ZBF/002/21

Raspador de lâmina longa anti-chispa



NSB704

		€		
100 mm	720 mm	189,99	1	NSB704-225

BAM/ZBF/003/21

Raspador triangular antichispa AL-BR



NS708

		€		
440 mm		163,88	1	NS708-360

BAM/ZBF/002/21

Raspador plano anti-chispa



NSB702

		€		
30 mm	325 mm	85,37	1	NSB702-200

BAM/ZBF/003/21

Raspador flexível antichispa AL-BR



NS706

		€		
50 mm	200 mm	76,30	1	NS706-50
80 mm	200 mm	117,09	1	NS706-80

BAM/ZBF/002/21

Raspador triangular anti-chispa



NSB708

		€		
450 mm		222,15	1	NSB708-360

BAM/ZBF/003/21

Raspador triangular antichispa AL-BR



NS710

L	€	Icon	Icon
470 mm	348,50	1	NS710-450

BAM/ZBF/002/21

Raspador triangular anti-chispa



NSB710

L	€	Icon	Icon
470 mm	472,36	1	NSB710-450

BAM/ZBF/003/21

FERRAMENTAS PARA SOLO

Picareta anti-chispa



NS800

L	€	Icon	Icon
910 mm	167,93	1	NS800-1100
910 mm	245,50	1	NS800-1700
965 mm	292,94	1	NS800-2000

BAM/ZBF/002/21

Picareta antichispa CU-BE



NSB800

L	g	€	Icon	Icon
910 mm	2000 g	273,93	1	NSB800-1100
910 mm	2800 g	400,46	1	NSB800-1700
910 mm	3200 g	477,86	1	NSB800-2000

BAM/ZBF/003/21

Pá redonda anti-chispa



NS802

L	€	Icon	Icon
1370 mm	223,13	1	NS802-290

BAM/ZBF/002/21

Pá redonda antichispa CU-BE



NSB802

L	€	Icon	Icon
1450 mm	426,73	1	NSB802-290

BAM/ZBF/003/21

Escova manual anti-chispa



NS804

L	€	Icon	Icon
290 mm	49,81	1	NS804-290

BAM/ZBF/002/21

EXTRATORES E PUXADORES

Extrator reversível de 3 maxilas antichispa AL-BR



NS810

Icon	Icon	€	Icon	Icon
50-100 mm	105 mm	1.059,01	1	NS810-100
60-150 mm	175 mm	1.175,67	1	NS810-150
70-200 mm	250 mm	1.256,16	1	NS810-200
80-350 mm	320 mm	1.882,02	1	NS810-350

BAM/ZBF/002/21

Extrator reversível de 3 maxilas antichispa CU-BE



NSB810

Icon	Icon	€	Icon	Icon
50-100 mm	105 mm	1.270,80	1	NSB810-100
60-150 mm	175 mm	1.410,80	1	NSB810-150
70-200 mm	250 mm	1.507,39	1	NSB810-200
80-350 mm	320 mm	2.540,71	1	NSB810-350

BAM/ZBF/003/21



FERRAMENTAS DINAMOMÉTRICAS

Chaves dinamométricas ajustáveis mecânicas sem faísca com escala de janela e cabeça de roquete fixa em bronze de alumínio



NS041



1/4"	5-25 N·m	1.516,07	1	NS041-8-25
3/8"	10-50 N·m	2.040,81	1	NS041-12-50
1/2"	20-100 N·m	2.320,37	1	NS041-16-100
1/2"	40-200 N·m	2.523,90	1	NS041-16-200
1/2"	60-260 N·m	2.722,94	1	NS041-16-260
3/4"	150-670 N·m	8.092,78	1	NS041-24-670
1"	200-900 N·m	9.192,02	1	NS041-32-900

BAM/ZBF/002/21

Chaves dinamométricas ajustáveis mecânicas sem faísca com escala de janela e cabeça de roquete fixa em cobre-berílio



NSB041



1/4"	5-25 N·m	2.607,76	1	NSB041-8-25
3/8"	10-50 N·m	2.979,02	1	NSB041-12-50
1/2"	20-100 N·m	3.444,21	1	NSB041-16-100
1/2"	40-200 N·m	3.693,59	1	NSB041-16-200
1/2"	60-260 N·m	3.942,95	1	NSB041-16-260
3/4"	150-670 N·m	12.254,91	1	NSB041-24-670
1"	200-900 N·m	14.454,50	1	NSB041-32-900

BAM/ZBF/003/21



Ferramentas em aço inoxidável



CHAVES DE BOCAS

Chaves ajustáveis de porca central em aço inoxidável



SS001

↕	↔	€	📦	🐟
100mm/4"	13 mm	90,91	1	SS001-100
150mm/6"	18 mm	102,46	1	SS001-150
200mm/8"	24 mm	149,23	1	SS001-200
250mm/10"	30 mm	184,27	1	SS001-250
300mm/12"	36 mm	243,99	1	SS001-300
375mm/15"	46 mm	378,88	1	SS001-375
450mm/18"	55 mm	447,81	1	SS001-450
600mm/24"	60 mm	750,62	1	SS001-600

Chaves boca luneta em aço inoxidável, mm



SS002

↕	€	📦	🐟
7 in	19,06	1	SS002-7
6 mm	13,02	1	SS002-6
8 mm	16,38	1	SS002-8
10 mm	20,34	1	SS002-10
11 mm	22,72	1	SS002-11
12 mm	23,92	1	SS002-12
13 mm	25,11	1	SS002-13
14 mm	26,31	1	SS002-14
15 mm	27,51	1	SS002-15
16 mm	28,71	1	SS002-16
17 mm	29,90	1	SS002-17
19 mm	31,10	1	SS002-19
21 mm	38,75	1	SS002-21
22 mm	41,85	1	SS002-22
24 mm	47,12	1	SS002-24
27 mm	68,18	1	SS002-27
32 mm	93,17	1	SS002-32

Conjuntos de chaves boca luneta em aço inoxidável, mm. 6 peças



SS002-6-2

↕	g	€	📦	🐟
6	710 g	155,50	1	SS002-6-2

SS002-8, SS002-10, SS002-12, SS002-14, SS002-17, SS002-19

Conjuntos de chaves boca luneta em aço inoxidável, mm. 9 peças



SS002-9-2

↕	g	€	📦	🐟
9	924 g	229,66	1	SS002-9-2

SS002-8, SS002-10, SS002-11, SS002-12, SS002-13, SS002-14, SS002-15, SS002-17, SS002-19

Chaves boca luneta em aço inoxidável, em polegadas



SS003

↕	↔	€	📦	🐟
1/4 in	105 mm	16,74	1	SS003-8
5/16 in	120 mm	18,19	1	SS003-10
11/32 in	135 mm	21,29	1	SS003-11
3/8 in	135 mm	23,33	1	SS003-12
7/16 in	150 mm	25,11	1	SS003-14
1/2 in	175 mm	27,51	1	SS003-16
9/16 in	175 mm	29,42	1	SS003-18
5/8 in	195 mm	31,10	1	SS003-20
11/16 in	195 mm	32,53	1	SS003-22

↕	↔	€	📦	🐟
3/4 in	215 mm	34,09	1	SS003-24
25/32 in	215 mm	40,66	1	SS003-25
13/16 in	245 mm	43,07	1	SS003-26
7/8 in	245 mm	44,25	1	SS003-28
15/16 in	265 mm	52,63	1	SS003-30

Chaves de luneta dupla offset em aço inoxidável, mm



SS011

↕	↔	€	📦	🐟
5.5*7 mm	180 mm	26,99	1	SS011-0507
6*7 mm	180 mm	27,60	1	SS011-0607
8*9 mm	190 mm	28,36	1	SS011-0809
8*10 mm	190 mm	28,64	1	SS011-0810
9*11 mm	215 mm	30,41	1	SS011-0911
10*12 mm	215 mm	30,89	1	SS011-1012
12*14 mm	225 mm	33,74	1	SS011-1214
14*17 mm	255 mm	39,00	1	SS011-1417
16*18 mm	280 mm	43,76	1	SS011-1618
17*19 mm	280 mm	47,86	1	SS011-1719
17*22 mm	300 mm	63,68	1	SS011-1722
22*24 mm	330 mm	72,95	1	SS011-2224
24*27 mm	340 mm	92,64	1	SS011-2427
24*30 mm	350 mm	131,77	1	SS011-2430
30*32 mm	370 mm	159,59	1	SS011-3032

Conjuntos chaves luneta dupla offset em aço inoxidável, mm. 9 peças



SS011-9-3

↕	g	€	📦	🐟
9	2470 g	614,76	1	SS011-9-3

SS011-0810, SS011-1012, SS011-1214, SS011-1417, SS011-1719, SS011-1722, SS011-2224, SS011-2427, SS011-3032

Conjuntos chaves luneta dupla offset em aço inoxidável, mm. 11 peças



SS011-11-3

Quantidade	Peso (g)	Preço (€)	Material	Referência
11	3100 g	776,99	1	SS011-11-3

SS011-0810, SS011-0911, SS011-1012, SS011-1214, SS011-1417, SS011-1719, SS011-1722, SS011-2224, SS011-2427, SS011-2430, SS011-3032

CHAVES DE CAIXA E ROQUETES

Chaves de caixa sextavadas de 1/4" em aço inoxidável



SS210

Diâmetro (mm)	Comprimento (mm)	Preço (€)	Material	Referência
4 mm	25 mm	13,33	1	SS210-4
4.5 mm	25 mm	13,33	1	SS210-4.5
5 mm	25 mm	13,33	1	SS210-5
5.5 mm	25 mm	13,33	1	SS210-5.5
6 mm	25 mm	16,05	1	SS210-6
7 mm	25 mm	17,48	1	SS210-7
8 mm	25 mm	19,54	1	SS210-8
9 mm	25 mm	21,87	1	SS210-9
10 mm	25 mm	23,17	1	SS210-10
11 mm	25 mm	25,75	1	SS210-11
12 mm	26 mm	29,12	1	SS210-12
13 mm	26 mm	31,06	1	SS210-13
14 mm	26 mm	32,23	1	SS210-14

Chaves de caixa sextavadas de 1/2" em aço inoxidável



SS220

Diâmetro (mm)	Comprimento (mm)	Preço (€)	Material	Referência
8 mm	40 mm	33,01	1	SS220-8
9 mm	40 mm	34,29	1	SS220-9
10 mm	40 mm	35,59	1	SS220-10

Diâmetro (mm)	Comprimento (mm)	Preço (€)	Material	Referência
11 mm	40 mm	37,53	1	SS220-11
12 mm	40 mm	40,12	1	SS220-12
13 mm	40 mm	41,41	1	SS220-13
14 mm	40 mm	43,36	1	SS220-14
15 mm	40 mm	46,59	1	SS220-15
16 mm	40 mm	48,54	1	SS220-16
17 mm	40 mm	50,47	1	SS220-17
18 mm	42 mm	53,06	1	SS220-18
19 mm	42 mm	55,65	1	SS220-19
20 mm	42 mm	58,24	1	SS220-20
21 mm	43 mm	59,54	1	SS220-21
22 mm	43 mm	60,82	1	SS220-22
23 mm	43 mm	66,00	1	SS220-23
24 mm	43 mm	69,89	1	SS220-24
25 mm	43 mm	73,77	1	SS220-25
26 mm	43 mm	84,12	1	SS220-26
27 mm	46 mm	86,71	1	SS220-27
28 mm	46 mm	93,18	1	SS220-28
29 mm	46 mm	97,06	1	SS220-29
30 mm	46 mm	102,25	1	SS220-30
31 mm	46 mm	112,59	1	SS220-31
32 mm	46 mm	112,59	1	SS220-32

Chaves de caixa sextavadas de 3/4" em aço inoxidável



SS224

Diâmetro (mm)	Comprimento (mm)	Preço (€)	Material	Referência
17 mm	50 mm	72,47	1	SS224-17
19 mm	50 mm	75,07	1	SS224-19
22 mm	55 mm	81,53	1	SS224-22
24 mm	55 mm	91,88	1	SS224-24
27 mm	55 mm	97,06	1	SS224-27
30 mm	60 mm	112,59	1	SS224-30
32 mm	60 mm	128,13	1	SS224-32
34 mm	60 mm	141,07	1	SS224-34
36 mm	60 mm	148,84	1	SS224-36
41 mm	65 mm	174,72	1	SS224-41
46 mm	65 mm	207,07	1	SS224-46
50 mm	70 mm	231,66	1	SS224-50
55 mm	75 mm	330,02	1	SS224-55
60 mm	75 mm	386,96	1	SS224-60
65 mm	80 mm	491,79	1	SS224-65

Extensões em aço inoxidável



SS234

Comprimento (mm)	Diâmetro (mm)	Preço (€)	Material	Referência
100 mm	1/2"	51,77	1	SS234-16-100
200 mm	1/2"	84,12	1	SS234-16-200
250 mm	1/2"	97,06	1	SS234-16-250

Comprimento (mm)	Diâmetro (mm)	Preço (€)	Material	Referência
100 mm	3/4"	112,59	1	SS234-24-100
200 mm	3/4"	122,94	1	SS234-24-200
250 mm	3/4"	169,20	1	SS234-24-250

Cardans universais em aço inoxidável



SS236

Comprimento (mm)	Diâmetro (mm)	Preço (€)	Material	Referência
56 mm	1/4"	61,78	1	SS236-08-80
80 mm	1/2"	84,12	1	SS236-16-80
110 mm	3/4"	148,84	1	SS236-24-110

Cabos corrediços em T em aço inoxidável



SS238

Comprimento (mm)	Diâmetro (mm)	Preço (€)	Material	Referência
250 mm	1/4"	113,89	1	SS238-08-250
250 mm	1/2"	115,18	1	SS238-16-250
350 mm	3/4"	161,77	1	SS238-24-350

Alavancas rotativas em aço inoxidável



SS243

Comprimento (mm)	Diâmetro (mm)	Preço (€)	Material	Referência
300 mm	1/4"	54,97	1	SS243-08
390 mm	1/2"	128,86	1	SS243-16
450 mm	3/4"	326,50	1	SS243-24



Roquetes em aço inoxidável



SS242

L	Ø	€	Icon	Icon
200 mm	1/4"	148,84	1	SS242-08-200
245 mm	1/2"	155,30	1	SS242-16-245
320 mm	3/4"	304,14	1	SS242-24-320

CHAVES DE PARAFUSOS

Chaves de parafusos em aço inoxidável ERGO™. Para parafusos de fenda



BE-8020i - BE-8252i

Ø	L	€	Icon	Icon
3.0 mm	60 mm	6,69	5	BE-8020I
3.5 mm	75 mm	7,21	5	BE-8030I
4.0 mm	100 mm	8,26	5	BE-8040I
5.5 mm	125 mm	10,50	5	BE-8241I
6.5 mm	150 mm	14,61	5	BE-8252I

Para parafusos de fenda

Chaves de parafusos em aço inoxidável ERGO™. Para parafusos Phillips



BE-8600i - BE-8623i

Icon	L	€	Icon	Icon
PH 0	60 mm	8,10	5	BE-8600I
PH 1	75 mm	10,03	5	BE-8610I
PH 2	100 mm	14,07	5	BE-8620I
PH 3	150 mm	21,27	5	BE-8623I

Para parafusos Phillips

Chaves de parafusos em aço inoxidável ERGO™. Para parafusos Pozidriv



BE-8800i - BE-8823i

Icon	L	€	Icon	Icon
PZ 0	60 mm	10,00	5	BE-8800I
PZ 1	75 mm	11,59	5	BE-8810I
PZ 2	100 mm	15,29	5	BE-8820I
PZ 3	150 mm	22,35	5	BE-8823I

Para parafusos Pozidriv

Chaves de parafusos em aço inoxidável ERGO™. Para parafusos TORX®



BE-8910i - BE-8925i

Icon	L	€	Icon	Icon
T 10	75 mm	9,79	5	BE-8910I
T 15	100 mm	9,87	5	BE-8915I
T 20	100 mm	10,00	5	BE-8920I
T 25	125 mm	10,67	5	BE-8925I

Para parafusos TORX®

Jogo de chaves de parafusos em aço inoxidável ERGO™, 6 pcs. Para parafusos de fenda e Phillips



BE-9881i

Icon	€	Icon	Icon
6	57,20	1	BE-9881I

Para parafusos de fenda e Phillips

BE-8020I, BE-8040I, BE-8241I, BE-8252I

BE-8610I, BE-8620I

Jogo de chaves de parafusos em aço inoxidável ERGO™, 6 pcs. Para parafusos de fenda e Pozidriv



BE-9882i

Icon	€	Icon	Icon
6	59,69	1	BE-9882I

Para parafusos de fenda e Pozidriv

BE-8020I, BE-8040I, BE-8241I, BE-8252I

BE-8810I, BE-8820I

CHAVES HEXAGONAIS OFFSET

Chaves Allen sextavadas. com ponta esférica longa em aço inoxidável, mm



SS324

Ø	L	€	Icon	Icon
1.5 mm	80 mm	4,21	2	SS324-1.5
2 mm	85 mm	4,21	2	SS324-2
2.5 mm	93 mm	4,21	2	SS324-2.5
3 mm	103 mm	4,52	1	SS324-3
4 mm	110 mm	4,95	1	SS324-4
5 mm	123 mm	6,03	1	SS324-5
6 mm	146 mm	6,68	1	SS324-6
8 mm	168 mm	10,44	1	SS324-8
10 mm	180 mm	12,91	1	SS324-10

Jogo de chaves de parafusos sextavados em esfera e em aço inoxidável, Offset, métrico, 9 pcs



BE-9770i

Icon	€	Icon	Icon
9	33,68	20	BE-9770I

SS324-1.5, SS324-2, SS324-2.5,
SS324-3, SS324-4, SS324-5, SS324-6,
SS324-8, SS324-10

Chaves Allen sextavadas. com ponta esférica longa em aço inoxidável, polegadas



SS325

Ø	L	€	Icon 1	Icon 2
5/64" in	85 mm	5,39	2	SS325-2.5
7/64" in	96 mm	7,18	2	SS325-3.5
1/8" in	101 mm	5,92	1	SS325-4
9/64" in	106 mm	9,57	1	SS325-4.5
5/32" in	111 mm	6,46	1	SS325-5
3/16" in	121 mm	8,61	1	SS325-6
7/32" in	132 mm	9,16	1	SS325-7
1/4" in	142 mm	9,69	1	SS325-8
5/16" in	163 mm	11,31	1	SS325-10
3/8" in	183 mm	13,99	1	SS325-12
3/32" in	90 mm	5,39	2	SS325-3

Conj. chaves parafusos offset sextavadas longas, ponta esférica, aço inox, polegadas, 13 pçs



BE-9786i

Icon X	Icon 1	€	Icon 2	Icon 3
13	0.05; 1/16; 5/64; 3/32; 7/64; 1/8; 9/64; 5/32; 3/16; 7/32; 1/4; 5/16; 3/8; in	41,86	1	BE-9786i

SS325-2.5, SS325-3, SS325-3.5,
SS325-4, SS325-4.5, SS325-5, SS325-6,
SS325-7, SS325-8, SS325-10,
SS325-12

BITS PARA CHAVES DE PARAFUSOS

Brocas de aparafusadora de torção de aço inoxidável 1/4" para parafusos Phillips de 25 mm



65I/PH

Icon X	Icon 1	€	Icon 2	Icon 3
10	1	28,05	1	65I/PH1
2	1	6,62	1	65I/PH1-2P
10	2	28,05	1	65I/PH2
2	2	6,62	1	65I/PH2-2P
10	3	28,05	1	65I/PH3
2	3	6,62	1	65I/PH3-2P

Brocas de aparafusadora de torção de aço inoxidável 1/4" para parafusos Pozidriv de 25 mm



65I/PZ

Icon X	Icon 1	€	Icon 2	Icon 3
10	1	28,05	1	65I/PZ1
2	1	6,62	1	65I/PZ1-2P
10	2	28,05	1	65I/PZ2
2	2	6,62	1	65I/PZ2-2P
10	3	28,05	1	65I/PZ3
2	3	6,62	1	65I/PZ3-2P

Brocas de aparafusadora de torção de aço inoxidável 1/4" para parafusos TORX® de 25 mm



65I/T

Icon X	Icon 1	€	Icon 2	Icon 3
5	T15	16,04	1	65I/T15
5	T25	15,27	1	65I/T25
5	T30	15,27	1	65I/T30
5	T40	16,04	1	65I/T40
2	T40	7,29	1	65I/T40-2P

Adaptador universal em inox com anel de retenção 1/4". KSR753 em caixa de plástico com 5 pcs e KSR753-1P em suporte de plástico por unidade



KSR753

Icon X	Icon 1	€	Icon 2	Icon 3
1	1/4 in	21,92	1	KSR753-1P
5	1/4 in	99,03	1	KSR753

KSR753 em caixa de plástico com 5 pcs e KSR753-1P em suporte de plástico por unidade

Conjunto de 7 peças de bits em aço inox para parafusos Pozidriv, Phillips, TORX® e suporte para bits



65I/7

Icon X	Icon 1	€	Icon 2	Icon 3
22 x 65 x 75 mm		26,36	1	65I/7-1

65I/PH2	Icon 1	Icon 2
65I/PZ2	Icon 1	Icon 2
65I/T15, 65I/T20, 65I/T25, 65I/T30	Icon 1	Icon 2

ALICATES

Alicate universal em aço inoxidável



SS400

L	€	Icon 1	Icon 2
155 mm	59,93	1	SS400-160
175 mm	75,07	1	SS400-180
200 mm	95,77	1	SS400-200



Alicate de corte diagonal em aço inoxidável



SS402

↔ L	€		
150 mm	64,32	1	SS402-160
195 mm	70,02	1	SS402-200

Alicate de duas posições em aço inoxidável. Cabos revestidos a PVC



SS412

↔ L	€		
200 mm	97,06	1	SS412-200

Alicate de pontas em aço inoxidável



SS406

↔ L	€		
150 mm	64,71	1	SS406-160
175 mm	74,68	1	SS406-200

Alicate de bomba de água em aço inoxidável



SS410

↔ L	€		
250 mm	99,65	1	SS410-250
300 mm	155,30	1	SS410-300

Alicate de pressão em aço inoxidável



SS415

↔ L	€		
255 mm	148,84	1	SS415-225

MARTELOS

Martelos de bola em aço inoxidável



SS506

↔ L	€		
200 g	37,53	1	SS506-200-FB
300 g	50,47	1	SS506-300-FB
450 g	54,36	1	SS506-500-FB
680 g	97,06	1	SS506-700-FB
900 g	112,59	1	SS506-900-FB
1100 g	128,13	1	SS506-1100-FB

Marretas em aço inoxidável



SS502

↔ L	€		
1000 g	110,01	1	SS502-1000-FB
1500 g	155,30	1	SS502-1500-FB
2000 g	199,31	1	SS502-2000-FB
2500 g	251,07	1	SS502-2500-FB
3000 g	297,66	1	SS502-3000-FB
3600 g	355,90	1	SS502-3600-FB

PUNÇÕES E FORMÕES

Alavancas em aço inoxidável



SS603

↔ L	€		
500 mm	80,24	1	SS603-15-500
500 mm	111,30	1	SS603-19-500
500 mm	114,42	1	SS603-20-500
500 mm	134,66	1	SS603-23-500
800 mm	207,07	1	SS603-23-800
600 mm	195,57	1	SS603-25-600
1000 mm	452,96	1	SS603-30-1000

Talhadeiras chatas em aço inoxidável



SS610

↔ L	€		
160 mm	38,83	1	SS610-16-160
200 mm	56,30	1	SS610-18-200
300 mm	176,01	1	SS610-24-300
400 mm	275,66	1	SS610-25-400
500 mm	372,73	1	SS610-30-500

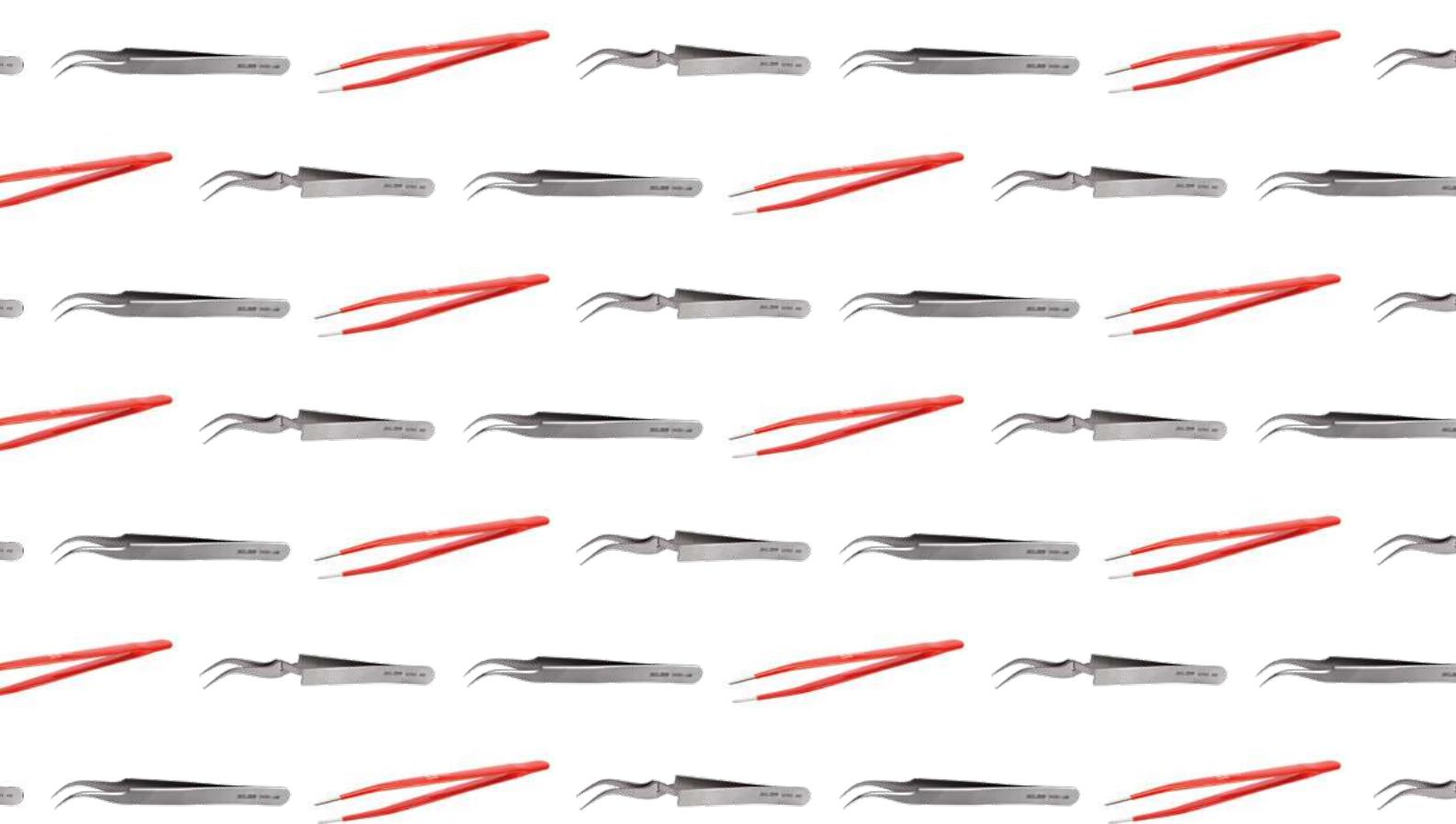

Ferramentas de precisão e ferramentas especiais para eletrônica



FERRAMENTAS DE PRECISÃO

Pinça para uso geral. Aço especial



5468

← L →	€		
112 mm	26,06	5	5468-112

Aço especial

Pinça para uso geral. Aço especial



5469

← L →	€		
127 mm	25,32	5	5469-127
127 mm	39,43	5	5469 R
127 mm	28,45	5	5469 I

Aço especial

Pinça para uso geral. Aço especial



5469B

← L →	€		
120 mm	24,46	5	5469 B
120 mm	26,18	5	5469 BI

Aço especial

Pinça ponteaguda. Aço especial



5479

← L →	€		
130 mm	18,88	5	5479-130

Aço especial

Pinça para uso geral. Aço especial



5471F

← L →	€		
120 mm	20,91	5	5471 F-120
145 mm	22,66	5	5471 F-145
200 mm	46,01	5	5471 F-200
250 mm	58,83	5	5471 F-250
300 mm	80,87	5	5471 F-300
120 mm	22,02	5	5471 FI-120
200 mm	44,29	5	5471 FI-200
120 mm	36,01	5	5471 FR-120
145 mm	40,85	5	5471 FR-145

Aço especial

Pinça especial. Aço especial



5475R/5475K

← L →	€		
150 mm	49,47	5	5475 R
100 mm	27,25	5	5475 K

Aço especial

Pinça especial. Aço especial



5516

← L →	€		
150 mm	24,03	5	5516
150 mm	26,36	5	5516 I

Aço especial

Pinça anti-magnética. Titânio



5465AMT

← L →	€		
110 mm	56,96	5	5465 AMT

Titânio

Pinça ponteaguda. Aço especial



5517

← L →	€		
155 mm	27,78	5	5517
155 mm	27,23	5	5517 I

Aço especial

Pinça especial. Aço especial



5518

← L →	€		
155 mm	30,35	5	5518

Aço especial

Pinça SMD para electrónica. Aço inoxidável, anti-magnética e anti-ácido



5540AM

← L →	€		
120 mm	41,77	5	5540 AM

Aço inoxidável, anti-magnética e anti-ácido

Pinça SMD para electrónica. Aço inoxidável, anti-magnética e anti-ácido



5541AM

	€		
120 mm	41,77	5	5541 AM

Aço inoxidável, anti-magnética e anti-ácido

Pinça SMD para electrónica. Aço inoxidável, anti-magnética e anti-ácido



5544AM

	€		
115 mm	41,77	5	5544 AM

Aço inoxidável, anti-magnética e anti-ácido

Pinça SMD para electrónica. Aço inoxidável, anti-magnética e anti-ácido



5545AM

	€		
120 mm	41,77	5	5545 AM

Aço inoxidável, anti-magnética e anti-ácido

Pinça SMD para electrónica. Aço inoxidável, anti-magnética e anti-ácido



5546AM

	€		
120 mm	41,77	5	5546 AM

Aço inoxidável, anti-magnética e anti-ácido

Pinça SMD para electrónica. Aço inoxidável, anti-magnética e anti-ácido



5547AM

	€		
120 mm	41,77	5	5547 AM

Aço inoxidável, anti-magnética e anti-ácido

Pinça SMD para electrónica. Aço inoxidável, anti-magnética e anti-ácido



5549AM

	€		
120 mm	41,77	5	5549 AM

Aço inoxidável, anti-magnética e anti-ácido

Pinça para electrónica. Aço inoxidável, anti-magnética e anti-ácido



5488AM

	€		
115 mm	41,77	5	5488 AM

Aço inoxidável, anti-magnética e anti-ácido

Pinça para electrónica. Aço inoxidável, anti-magnética e anti-ácido



5489AM

	€		
115 mm	41,77	5	5489 AM

Aço inoxidável, anti-magnética e anti-ácido

Pinça para electrónica. Aço inoxidável, anti-magnética e anti-ácido



5490AM

	€		
115 mm	41,77	5	5490 AM

Aço inoxidável, anti-magnética e anti-ácido

Pinça para montagem. Aço inoxidável, anti-magnética



5573

	€		
145 mm	63,67	5	5573-145

Aço inoxidável, anti-magnética

Pinça para montagem. Aço inoxidável, anti-magnética



5578

	€		
122 mm	45,20	5	5578-115

Aço inoxidável, anti-magnética

Pinça para montagem. Aço inoxidável, anti-magnética



5579

	€		
115 mm	45,20	5	5579-115

Aço inoxidável, anti-magnética



Pinça SMD para electrónica. Aço inoxidável, anti-magnética e anti-ácido



5588AM

	€		
120 mm	41,77	5	5588 AM

Aço inoxidável, anti-magnética e anti-ácido

Pinça SMD para electrónica. Aço inoxidável, anti-magnética e anti-ácido



5589AM

	€		
120 mm	41,77	5	5589 AM

Aço inoxidável, anti-magnética e anti-ácido

Pinça SMD para electrónica. Aço inoxidável, anti-magnética e anti-ácido



5590AM

	€		
120 mm	41,77	5	5590 AM

Aço inoxidável, anti-magnética e anti-ácido

Conjunto de pinças SMD para electrónica. Aço inoxidável, anti-magnético e anti-ácido



5568/5

	€		
100 g	222,68	1	5568/5

Aço inoxidável, anti-magnético e anti-ácido

5489 AM	
5583 AM	
5589 AM	
5584 AM	
5546 AM	

Pinça de relojoeiro. Aço especial



5463

	€		
120 mm	34,03	5	5463-120
120 mm	56,96	5	5463 R

Aço especial

Pinça para ourives. Aço especial



5470

	€		
120 mm	21,66	5	5470-120

Aço especial

Pinça. Aço inoxidável, anti-magnética - ponta de cobre



5577

	€		
145 mm	64,38	5	5577-145

Aço inoxidável, anti-magnética - ponta de cobre

Pinça de relojoeiro. Aço especial



5465

	€		
105 mm	54,08	5	5465 R

Aço especial

Pinça para corte. Aço inoxidável, anti-magnética e anti-ácido



5493

	€		
115 mm	66,50	5	5493-115

Aço inoxidável, anti-magnética e anti-ácido

Pinça para soldadura. Aço especial



5476H

	€		
160 mm	63,96	5	5476 H

Aço especial

FERRAMENTAS DE SOLDAR

Pistola de soldar. 3250010SH: ponta suplente



3250		W	°C	€	Icon	Icon
100 W	400 °C	83,42	1	325001000		
		4,68	1	3250010SH		

3250010SH: ponta suplente

Ferro de soldar trabalho pesado



322500		W	°C	€	Icon	Icon
30 W	370 °C	44,04	1	322500300		
40 W	375 °C	46,67	1	322500500		
80 W	380 °C	49,64	1	322500800		

Ferro de soldar Electronico, leve e compacto



32600		W	°C	€	Icon	Icon
18 W	390 °C	51,25	1	326000200		
25 W	420 °C	55,58	1	326000300		

Ferro Soldar com temperatura controlada



3270		W	°C	€	Icon	Icon
50 W	200-500 °C	105,91	1	327020500		

Pontas para ferro de soldar. Rett og vinklet



3225		€	Icon	Icon
1.5 x 2.5 mm	8,61	1	322510300	
1.5 x 2.5 mm	8,61	1	322510400	
2 x 3 mm	8,61	1	322510500	
2 x 3 mm	8,61	1	322510600	
2.5 x 5 mm	8,61	1	322510700	
2.5 x 5 mm	8,61	1	322510800	

Rett og vinklet

Ponta substituição para ferro soldar



326010		g	€	Icon	Icon
5 g	7,49	1	326010200		
5 g	7,55	1	326020200		
5 g	7,55	1	326030200		

Pontas supl. p/ferro de soldar c/temp. contr. 3270. SH1=red.0,5 mm;SH2=plana 2 mm;SH3=plana 3 mm;SH4=plana 4 mm



327020500-SH		€	Icon	Icon
0,5mm	8,02	1	327020500-SH1	
2mm	8,02	1	327020500-SH2	
3mm	8,02	1	327020500-SH3	
4mm	8,02	1	327020500-SH4	

Solda sem chumbo (Sn). Ø 0.8 mm



3290		€	Icon	Icon
2000 mm	4,52	1	329000330	
4000 mm	5,58	1	329000500	

Ø 0.8 mm

MEÂNICA DE PRECISÃO

Jogo de ganchos diversos



2633/		€	Icon	Icon
17 x 80 x 150 mm	25,87	12	2633/S4	
12 x 12 x 275 mm	26,36	12	2633L/S4	



Gancho duplo para fios e molas



5418

	€		
145 mm	46,79	1	5418

Chaves de parafusos ajustáveis, com guia



5550

	€		
140 mm	18,76	10	5550-3.2
140 mm	21,13	10	5550-4.5

Pinças de descarnar



2530-32/2530-40

	€		
130 mm	46,82	5	2530-40

Conjunto de ferramentas para fios e molas



5419/6T

	€		
5 x 78 x 110 mm	54,70	1	5419/6T

Ferramentas de afinação



5551-5554

	€		
220 mm	19,62	1	5551
205 mm	19,62	1	5552
195 mm	19,62	1	5553
180 mm	19,62	1	5554

Raspador estirado



2487

	€		
210 mm	17,36	12	2487

Raspador triangular



3524

	€		
24 g	34,88	1	3524
5 g	16,75	1	3524-L-K

Saca componentes



ergo



BE-3529

	€		
197 mm	18,90	5	BE-3529

Conjunto de ferramentas de afinação



5600/4

	€		
75 g	91,66	1	5600/4

Raspador triangular



3525HB

	€		
168 mm	27,03	5	3525HB

5551, 5552, 5553, 5554



Medição e organização



FITAS MÉTRICAS

Fita Métrica Superior



MTS

L	mm	€	Icon	Icon	Model
5 m	25 mm	32,49	6		MTS-5-25
5 m	25 mm	32,49	6		MTS-5-25-E
8 m	25 mm	40,13	6		MTS-8-25
8 m	25 mm	40,13	6		MTS-8-25-E

Fita Métrica



MTB

L	mm	€	Icon	Icon	Model
3 m	16 mm	11,76	6		MTB-3-16
3 m	16 mm	13,41	6		MTB-3-16-M
3 m	16 mm	13,41	6		MTB-3-16-M-E
5 m	25 mm	24,03	6		MTB-5-25
5 m	25 mm	25,71	6		MTB-5-25-M
5 m	25 mm	25,71	6		MTB-5-25-M-E
8 m	25 mm	36,58	6		MTB-8-25
8 m	25 mm	39,01	6		MTB-8-25-M
8 m	25 mm	39,01	6		MTB-8-25-M-E

Fita métrica Classe I



MTB_C1

L	mm	€	Icon	Icon	Model
5 m	25 mm	35,59	6		MTB-5-25-C1

Fita Métrica



MTG

L	mm	€	Icon	Icon	Model
3 m	16 mm	5,26	12		MTG-3-16
3 m	16 mm	5,26	12		MTG-3-16-E
5 m	19 mm	8,28	12		MTG-5-19
5 m	19 mm	8,28	12		MTG-5-19-E
8 m	25 mm	10,53	4		MTG-8-25
8 m	25 mm	10,53	4		MTG-8-25-E

FITA MÉTRICA COMPACTA



MTC_C1

L	mm	€	Icon	Icon	Model
3 m	13 mm	11,34	6		MTC-3-13-C1
5 m	16 mm	12,71	6		MTC-5-16-C1

Fita métrica compacta Classe II



MTC_C2

L	mm	€	Icon	Icon	Model
3 m	13 mm	8,15	6		MTC-3-13
5 m	16 mm	9,93	6		MTC-5-16

FITA MÉTRICA COMPACTA 3m



MT-TS-3

L	mm	€	Icon	Icon	Model
3 m	13 mm	9,85	12		MT-TS-3

Fita métrica em aço flexível



1162N

L	mm	€	Icon	Icon	Model
3 m	13 mm	23,36	1		1162N-1/2

Fita de bancada autocolante. L is left reading, R is right reading



BT

L	mm	€	Icon	Icon	Model
3 m	13 mm	7,25	12		BTR-3-13
6 m	13 mm	9,26	12		BTR-6-13
3 m	13 mm	7,25	12		BTL-3-13
6 m	13 mm	9,26	12		BTL-6-13

Fita Métrica Longa



LTG

L	mm	€	Box	Icon
10 m	10 mm	16,70	6	LTG-10
20 m	10 mm	22,38	6	LTG-20
30 m	10 mm	26,83	6	LTG-30

Fita Métrica Longa



LTS

L	mm	€	Box	Icon
30 m	13 mm	28,27	5	LTS-30
30 m	13 mm	28,27	5	LTS-30-E
50 m	13 mm	38,96	5	LTS-50
50 m	13 mm	38,96	5	LTS-50-E
100 m	13 mm	82,18	5	LTS-100
100 m	13 mm	82,18	5	LTS-100-E

NÍVEIS DE BOLHA

Nível Ultra Resistente



Fita Métrica Longa



LTB

L	mm	€	Box	Icon
10 m	13 mm	19,94	6	LTB-10
20 m	13 mm	22,62	6	LTB-20
30 m	13 mm	29,24	6	LTB-30

RODAS DE MEDIÇÃO

Roda Medição 150 mm



MW-150

L	€	Box	Icon
150 mm	76,06	2	MW-150

466

L	€	Box	Icon
400 mm	32,59	4	466-400
400 mm	40,96	4	466-400-M
600 mm	39,67	4	466-600
600 mm	48,12	4	466-600-M
800 mm	43,03	4	466-800
800 mm	52,00	4	466-800-M
1000 mm	48,11	4	466-1000
1000 mm	59,61	4	466-1000-M
1200 mm	58,24	4	466-1200
1200 mm	70,94	4	466-1200-M
1800 mm	75,11	4	466-1800
2000 mm	91,62	4	466-2000

Fita métrica longa



LT-STEEL

L	mm	€	Box	Icon
30 m	13 mm	67,31	5	LT-STEEL-30
50 m	13 mm	105,38	5	LT-STEEL-50

Roda Medição 250 mm



MW-250

L	€	Box	Icon
940 mm	136,43	2	MW-250

Níveis



426

L	mm	€	Box	Icon
400 mm	49x22 mm	31,61	1	426-400
600 mm	49x22 mm	35,65	1	426-600
800 mm	49x22 mm	39,82	1	426-800
1000 mm	49x22 mm	47,26	1	426-1000
1200 mm	49x22 mm	55,59	1	426-1200



NÍVEL DE BOLHA DE AR



416

Comprimento	€	Unidade	Modelo
400 mm	15,97	10	416-400
600 mm	18,73	10	416-600
800 mm	21,60	10	416-800
1000 mm	26,69	10	416-1000
1200 mm	30,26	10	416-1200
1500 mm	34,20	10	416-1500
1800 mm	39,77	10	416-1800
2000 mm	47,38	10	416-2000

Nível fabricado em alumínio injetado sólido



405

Comprimento	€	Unidade	Modelo
400 mm	29,76	5	405-400
600 mm	35,59	5	405-600
800 mm	45,29	10	405-800
1000 mm	60,82	5	405-1000

Nível magnético fabricado em alumínio injetado sólido



405_M

Comprimento	€	Unidade	Modelo
400 mm	33,53	5	405-400-M
600 mm	39,47	5	405-600-M
800 mm	49,06	5	405-800-M
1000 mm	64,59	5	405-1000-M

Nível leve fabricado em alumínio injetado maciço



405L

Comprimento	€	Unidade	Modelo
400 mm	27,18	10	405L-400
600 mm	33,01	10	405L-600

Nível magnético leve fabricado em alumínio injetado maciço



405L_M

Comprimento	€	Unidade	Modelo
400 mm	30,41	5	405L-400-M
600 mm	36,89	5	405L-600-M

Nível sólido, precisão de 0.5mm/m. modelos-M têm base magnética



406

Comprimento	€	Unidade	Modelo
300 mm	35,56	1	406-300
400 mm	40,29	5	406-400
500 mm	48,61	5	406-500
600 mm	47,65	5	406-600
800 mm	56,36	5	406-800

modelos-M têm base magnética

Níveis de bolha magnéticos de alumínio injetado sólido



406_M

Comprimento	Unidade	€	Unidade	Modelo
300 mm	1	48,86	5	406-300-M
400 mm	1	53,72	5	406-400-M
500 mm	1	58,90	5	406-500-M
600 mm	1	57,74	5	406-600-M

Nível de bolha de ar de plástico poliestireno



406P

Comprimento	Unidade	€	Unidade	Modelo
400 mm	10	10,20	10	406P-400
600 mm	10	12,91	10	406P-600

BOLSA DE TRANSPORTE 416-SET-1 PLUS. BOLSA IS 4750-LV-1



416-SET+BAG

Quantidade	€	Unidade	Modelo
3	101,07	1	416-SET+BAG

416-SET-1

4750-LV-1

CONJUNTO DE NÍVEL DE BOLHA DE AR DE 3 PEÇAS



416-SET-1



€



3 68,26 5 416-SET-1

416-600, 416-1200, 416-1800



CONJUNTO DE NÍVEL DE BOLHA DE AR DE 3 PEÇAS



416-SET-2



€



3 71,12 5 416-SET-2

416-600, 416-1200, 416-2000



NÍVEL TORPEDO MAGNÉTICO DE PLÁSTICO



406T-225



€



228 mm 6,80 10 406T-225

Nível



426TOR9



€



230 mm 23,03 10 426TOR9

Nível torpedo



466-250



€



250 mm 29,24 10 466-250

Nível de linha



466-LINE



€



75 mm 5,34 12 466-LINE

Nível de duas posições



466-BE1



€



20 g 6,43 12 466-BE1

Nível de coluna



466-POST



€



120 x 75 x 80 mm 9,02 6 466-POST

Nível de bordo reto



486



€



1800 mm 58,84 5 486-1800
2000 mm 64,52 5 486-2000
2400 mm 75,73 5 486-2400

Nível de bordo reto SEM CABOS



486-xxxWH



€



1800 mm 58,84 5 486-1800WH
2000 mm 64,52 5 486-2000WH
2400 mm 75,73 5 486-2400WH

NÍVEL DE PERFIL DE DUPLO T



496



€



1500 mm 73,42 5 496-1500
1800 mm 85,67 5 496-1800



Ampola sobresselente para níveis 496



496-SPARE

	€		
496-1500, 496-1800	7,46	1	496-SPARE

MARCAÇÃO

Traçador de retas de 30 m, 5x recolhível



CL-1441

	€		
185 mm	24,27	36	CL-1441

Traçador de retas, 1x recolhível



CL-1331

	€		
185 mm	18,76	48	CL-1331

Traçador de rectas recolhível. CL-1221-SET: 227g frasco de giz azul, 75 mm nível da linha + CL-1221



CL-1221

	€		
130 mm	12,17	6	CL-1221

CL-1221-SET: 227g frasco de giz azul, 75 mm nível da linha + CL-1221

Pó Giz 227gr



CHALK

	€		
227 g	3,09	6	CHALK-BLUE
227 g	3,28	6	CHALK-WHITE
227 g	3,09	6	CHALK-RED
227 g	3,09	6	CHALK-YELLOW

LINHA DE GIZ, GIZ AZUL, NÍVEL DE LINHA



CL-1221-SET

	€		
180 g	17,68	4	CL-1221-SET

CHALK-BLUE

466-LINE

CL-1221

Fio de prumo



PBS

	€		
5 m	24,63	6	PBS-700

Prumo com ponta de aço temperado



PBB

		€		
185 mm	227 g	24,10	8	PBB-8

Lapis HB



P-HB

		€		
175 mm	25	0,77	25	P-HB

Código do Certificado FSC: QMI-COC-001417 Arquivo n°: 1627439

EXPOSITOR DE 200 LÁPIS P-HB. EM CAIXA DE ARAME METALICO



PENCIL-200

		€			
180 mm	200	181,35	1	PENCIL-200-DISP	

Dureza HB, lapiseira de carpinteiro



P-MEC

		€			
150 mm	1	5,53	24	P-MEC	
100 mm	5	4,01	12	P-MEC-LEAD	

Traçador com ponta de substituição. Spissdiameter 2,5 mm. Kroppdiameter 8 mm.



1179-SCRIBE

	€			
150 mm	21,44	5	1179-SCRIBE	
	7,43	1	1179-TIPS	

Spissdiameter 2,5 mm. Kroppdiameter 8 mm.

Traçador em carbono Tungstênio. Diâmetro 2.5mm



1178-SCRIBE

	€			
150 mm	7,31	5	1178-SCRIBE	

Diâmetro 2.5mm

Traçador Offset. Diâmetro de 4mm e ângulo de 70°



1177-SCRIBE

	€			
230 mm	6,53	5	1177-SCRIBE	

Diâmetro de 4mm e ângulo de 70°

RÉGUAS

Régua de madeira 1m. MM apenas metrica



WR1

		€			
1 m	17 mm	4,66	50	WR1	
1 m	17 mm	4,67	50	WR1-MM	

MM apenas metrica

Régua de madeira 2m. MM apenas metrica



WR2

		€			
2 m	17 mm	6,21	25	WR2	
2 m	17 mm	7,48	25	WR2-MM	

MM apenas metrica

Régua de madeira 2m secção 12



WR2-12

		€			
2 m	17 mm	6,21	25	WR2-12	

Régua flexível



1179-FLX

		€			
160 mm	12 mm	2,71	25	1179-FLX	

Régua de aço. - versão E métrica/imperial



SR MM

		€			
150 mm	19 mm	2,07	12	SR150-MM	
200 mm	19 mm	2,71	12	SR200-MM	
300 mm	25 mm	3,64	12	SR300-MM	
600 mm	30 mm	7,12	20	SR600-MM	
1000 mm	35 mm	14,98	20	SR1000-MM	

- versão E métrica/imperial



Régua de aço



SR IN

L	SR IN	€	Icon 1	Icon 2
6 in	6 in	2,07	12	SR150-E
8 in	8 in	2,71	12	SR200-E
12 in	12 in	3,64	12	SR300-E
24 in	24 in	7,12	20	SR600-E
39 in	40 in	14,98	20	SR1000-E

ESQUADROS

Esquadro



9045-B

L	SR IN	€	Icon 1	Icon 2
220 mm	170 mm	25,55	6	9045-B-200
250 mm	170 mm	27,04	6	9045-B-250
300 mm	170 mm	29,49	6	9045-B-300
400 mm	170 mm	34,39	1	9045-B-400

Esquadro Carpinteiro



9048

L	SR IN	€	Icon 1	Icon 2
200 mm	165 mm	20,53	10	9048-200
250 mm	165 mm	21,24	10	9048-250
300 mm	180 mm	24,26	10	9048-300
350 mm	180 mm	24,29	10	9048-350
400 mm	180 mm	25,71	10	9048-400

Esquadro para construção

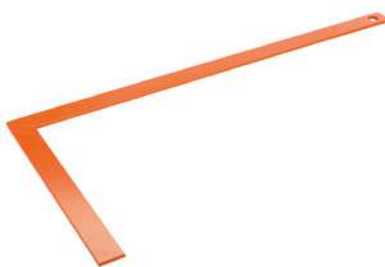

3085

L	SR IN	€	Icon 1	Icon 2
400 mm	200 mm	19,08	1	308504000
500 mm	250 mm	20,94	1	308505000
600 mm	300 mm	24,19	1	308506000
800 mm	400 mm	29,43	1	308508000
1000 mm	500 mm	33,04	1	308510000

Esquadros Combinados



CS

L	SR IN	€	Icon 1	Icon 2
152 mm	90 mm	12,75	12	CS150
305 mm	125 mm	23,72	12	CS300
407 mm	125 mm	26,40	12	CS400

Kit de peças sobresselentes para régulas deslizantes modelo CS - 4 peças



CS-SPARE

L	SR IN	€	Icon 1	Icon 2
CS150, CS300, CS400		4,44	1	CS-SPARE

Suta



9572

L	SR IN	€	Icon 1	Icon 2
235 mm	115 mm	25,52	20	9572-200
250 mm	150 mm	27,07	20	9572-250

Suta



9574

L	SR IN	€	Icon 1	Icon 2
215 mm	165 mm	20,86	10	9574-200
285 mm	170 mm	21,40	10	9574-250
300 mm	170 mm	22,65	10	9574-300

Esquadro



9575

L	SR IN	€	Icon 1	Icon 2
250 mm	110 mm	31,63	6	9575-250

ESQUADRO DE CARPINTEIRO PLANO



FCS-600/FCS-1000

Length (mm)	Width (mm)	Price (€)	Quantity	Model
600	300	21,69	6	FCS-600
800	300	23,04	6	FCS-800
1000	360	25,22	6	FCS-1000

Paquímetro digital



1150

Length (mm)	Width (mm)	Price (€)	Quantity	Model
150	9 x 75 x 235	59,27	1	1150-1/2H/P

Apalpa folgas métrico



1547

Quantity	Length (mm)	Price (€)	Quantity	Model
20	100	13,88	20	1547

ESQUADRO AJUSTÁVEL PARA GESSO



AS-1200

Length (mm)	Width (mm)	Price (€)	Quantity	Model
1265	560	65,94	3	AS-1200

Apalpa folgas métrico



1544

Quantity	Length (mm)	Price (€)	Quantity	Model
26	100	17,03	1	1544

Medidores de inclinação de parafusos com métrica 60°



1535

Quantity	Length (mm)	Price (€)	Quantity	Model
24	67	9,16	1	1535

MEDIÇÃO DE PRECISÃO

Paquímetro digital



1150D

Length (mm)	Width (mm)	Price (€)	Quantity	Model
150	25 x 90 x 245	72,09	1	1150D

Apalpa folgas profissional



1546

Length (mm)	Price (€)	Quantity	Model
100	10,09	1	1546

Conta fios - Métrico 60° & Whitworth 55°



1537

Thread Size	Length (mm)	Price (€)	Quantity	Model
0.25-6.0 / 4-62	70	14,37	1	1537





BAHCO



Ferramentas para paredes



RASPADORES

Raspador de bolso



ergo



625



25 mm

€

30,10



5

625

Lâminas de substituição para raspadores 625 ERGO™



449



25 mm

€

13,30



10

449

Lâminas de substituição para raspador 625



625-



3 g

€

13,30



10 625-DROP

3 g

13,30



10 625-PEAR

3 g

13,30



10 625-ROUND

Raspador ergonomico



ergo



650



50 mm

€

29,42



5

650

Lâminas de substituição para raspadores 650 ERGO™



442



50 mm

€

22,85



10

442-3P

50 mm

14,10



10

442

Lâmina de raspador para pintura



850 / 865



50 mm

€

17,59



10 850-1

65 mm

19,40



10 865-1

Raspador ergonomico



ergo



665



65 mm

€

42,59



5

665

Lâminas de substituição para raspadores 665 ERGO™



451



65 mm

€

15,52



10

451

Conjunto de raspadores Ergonomicos



ergo



SCRAPER-SET2



50 x 145 x 265 mm

€

108,01



1 SCRAPER-SET2

625

625-DROP, 625-PEAR, 625-ROUND

650



Raspador com lâmina em aço temperado



474

↔ L	€	📦	🐟
130 mm	9,86	10	474-125-0.60
130 mm	10,01	10	474-125-0.80
150 mm	10,35	10	474-150-0.60
150 mm	10,52	10	474-150-0.80

Bi material aço carbono



2150

↔ L	€	📦	🐟
30 mm 225 mm	4,52	12	215000030
40 mm 225 mm	4,69	12	215000040
50 mm 225 mm	4,87	12	215000050
60 mm 225 mm	5,00	12	215000060
70 mm 225 mm	5,39	12	215000070
80 mm 225 mm	5,70	12	215000080
90 mm 220 mm	6,14	12	215000090
100 mm 220 mm	6,89	12	215000100
120 mm 220 mm	8,45	12	215000120

Raspador para enchimento



2190

↔ L	€	📦	🐟
100 mm 235 mm	6,58	5	219001000
120 mm 230 mm	7,28	5	219001200
140 mm 245 mm	8,14	5	219001400
160 mm 235 mm	8,86	5	219001600
200 mm 245 mm	11,63	5	219002000

Raspador com cabo de madeira



2155

↔ L	€	📦	🐟
30 mm 195 mm	7,42	12	215500300
40 mm 195 mm	8,07	12	215500400
50 mm 195 mm	8,28	12	215500500
60 mm 215 mm	8,44	12	215500600
70 mm 220 mm	8,64	12	215500700
80 mm 225 mm	9,04	12	215500800
90 mm 230 mm	9,23	12	215500900
100 mm 234 mm	9,63	12	215501000

Cabo de raspador bi material



2161

↔ L	€	📦	🐟
40 mm 215 mm	8,35	12	216100040
60 mm 215 mm	9,79	12	216100060
80 mm 215 mm	11,00	12	216100080
100 mm 235 mm	11,64	12	216100100
120 mm 235 mm	12,58	12	216100120

Raspador para enchimento em inox



2192

↔ L	€	📦	🐟
100 mm 235 mm	10,66	5	219201000
120 mm 230 mm	11,67	5	219201200
140 mm 235 mm	14,32	5	219201400
160 mm 245 mm	15,88	5	219201600
200 mm 235 mm	19,94	5	219202000

Raspador com cabo de plástico



216

↔ L	€	📦	🐟
30 mm 210 mm	3,84	12	216000300
40 mm 210 mm	3,95	12	216000400
50 mm 210 mm	4,15	12	216000500
60 mm 210 mm	4,26	12	216000600
70 mm 210 mm	4,59	12	216000700
80 mm 210 mm	4,82	12	216000800
90 mm 228 mm	5,09	12	216000900
100 mm 230 mm	5,84	12	216001000
120 mm 230 mm	6,84	12	216001200

Cabo de plástico e lâmina rígida de aço carbono



2165

↔ L	€	📦	🐟
30 mm 180 mm	7,32	12	216500300
50 mm 180 mm	7,75	12	216500500
75 mm 200 mm	9,79	12	216500750
100 mm 200 mm	11,00	12	216501000

Raspador para enchimento em inox



2193

↔ L	€	📦	🐟
250 mm	18,70	10	219302500
300 mm	20,07	10	219303000
350 mm	21,41	10	219303500



Raspador de cola de pente



2212

W	L	€	PK	PK
130 mm	120 mm	5,50	5	221201200
130 mm	200 mm	6,71	5	221202000
130 mm	300 mm	9,80	5	221203000

Raspador de cola de pente



2213

W	L	€	PK	PK
130 mm	120 mm	5,50	5	221301200
130 mm	200 mm	6,53	5	221302000
130 mm	300 mm	9,80	5	221303000

Navalha de electricista em forma de gancho



2488

€	PK	PK
19,19	12	2488

Espátula



2489

€	PK	PK
23,59	12	2489

Colher tipo madrid



2303

W	L	€	PK	PK
70 mm	110 mm	18,26	6	2303B0000
80 mm	135 mm	19,25	6	2303D0000

Colher tipo sevilha



2304

W	L	€	PK	PK
115 mm	200 mm	22,80	6	2304C0000

Colher ponta afiada



2308

W	L	€	PK	PK
120 mm	70 mm	18,67	6	2308A0000
150 mm	100 mm	19,37	6	2308B0000

FERRAMENTAS PARA ALVENARIA

Talocha rectangular



204

W	L	€	PK	PK
300 mm	150 mm	15,58	12	204030150
300 mm	160 mm	16,62	12	204030160
300 mm	180 mm	17,51	12	204030180
500 mm	130 mm	26,52	6	204050130

Talocha de pente dentes de serra



209

W	L	€	PK	PK
270 mm	115 mm	16,20	12	209027040

Talocha de dois dentes



2092

Icon 1	Icon 2	€	Icon 3	Icon 4
275 mm	115 mm	15,73	12	209227060
280 mm	130 mm	16,62	12	209228100
500 mm	130 mm	28,16	6	209250100

Talocha rectangular, aço inoxidável



2045

Icon 1	Icon 2	€	Icon 3	Icon 4
300 mm	140 mm	18,58	12	204530140
500 mm	130 mm	28,58	6	204550130

Talocha de rebocar em aço inoxidável



2045A

Icon 1	Icon 2	€	Icon 3	Icon 4
140 mm	300 mm	20,25	12	2045A3000

Talocha rectangular em plástico



211

Icon 1	Icon 2	€	Icon 3	Icon 4
350 mm	180 mm	8,02	5	211035180
420 mm	210 mm	10,49	5	211042210

Talocha rectangular em plástico



2120

Icon 1	Icon 2	€	Icon 3	Icon 4
270 mm	180 mm	6,20	5	212027180
330 mm	220 mm	6,72	8	212033220

Nivel de alumínio



2127

Icon 1	Icon 2	€	Icon 3	Icon 4
90 mm	435 mm	41,66	6	212704350

Calha de reboco



2145xxxD

Icon 1	€	Icon 2	Icon 3
45 x 20 x 275 mm	13,02	1	2145020D0
45 x 25 x 275 mm	13,16	1	2145025D0
45 x 30 x 275 mm	13,33	1	2145030D0
45 x 35 x 275 mm	13,59	1	2145035D0

Calha de reboco: reto



2145xxxL

Icon 1	€	Icon 2	Icon 3
45 x 20 x 275 mm	13,02	1	2145020L0
45 x 25 x 275 mm	13,16	1	2145025L0
45 x 30 x 275 mm	13,33	1	2145030L0
45 x 35 x 275 mm	13,59	1	2145035L0

Talocha rectangular em plástico com ponta



213

Icon 1	Icon 2	€	Icon 3	Icon 4
265 mm	140 mm	5,14	5	213026140



Calha de reboco: curvo



2145xxxC

	€		
45 x 25 x 225 mm	13,59	1	2145025C0
45 x 35 x 210 mm	13,93	1	2145039C0

Talocha rectangular de borracha dura



2125

		€		
220 mm	135 mm	12,58	10	212502150



Cabo para suporte de placas



250400020

	€		
180 g	72,11	1	250400020

Talocha rectangular com base em borracha



2122

		€		
250 mm	100 mm	20,97	10	212202500



Talocha rectangular de borracha macia



2126

		€		
140 mm	220 mm	14,75	10	212602150
140 mm	280 mm	19,33	1	212602800



Conjunto de peças para suporte de placas



250400030

	€		
80 g	135,47	1	250400030

Talocha rectangular com base em espuma



2123

		€		
140 mm	280 mm	15,60	10	212302900



FERRAMENTAS PARA GESSO CARTONADO

CONJUNTO DE ELEVAÇÃO DE SUBSTITUIÇÃO (2 MOLAS + TRAVÃO)



250400010

	€		
80 g	40,88	1	250400010

Ferramenta de fixação



250501800

	€		
185 mm	65,87	50	250501800



Ferramenta de fixação



250502450

	€		
245 mm	73,38	1	250502450

CHANFRO DE SUBSTITUIÇÃO PARA 864



864000020

	€		
20 g	11,63	1	864000020

Pinça para unir perfis



671002600

	€		
260 mm	148,67	50	671002600

Cortador de guarnição



8640

	€		
230 mm	66,34	50	864002450

Cortador de guarnição



8641

	€		
245 mm	63,72	1	864102400

Pinça para unir perfis



671002850

	€		
295 mm	113,57	1	671002850

LÂMINA DE SUBSTITUIÇÃO PARA 8640



864000010

	€		
20 g	20,40	1	864000010

LÂMINA DE SUBSTITUIÇÃO PARA 8641



864100010

	€		
5 g	11,73	1	864100010





BAHCO



Lâminas para serrote



ARMAÇÃO DE SERROTE

Armação de serrote para metais - profissional



ergo



325



300 mm € 48,23 5 325

Armação de serrote para metais - profissional



225-PLUS

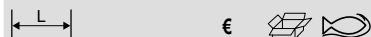

300 mm € 31,08 5 225-PLUS

Armação de serrote para metais - profissional



319



300 mm € 26,91 5 319

Armação de serrote para metais - compacto



317



432 mm € 19,50 10 317

Armação de serrote para metais - compacto



306



440 mm € 15,14 10 306

Armação tradicional de serrote para metais



320



504 mm € 22,40 10 320

Armação de serrote para metais



304

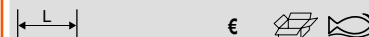

517 mm € 7,89 10 304

Mini serrote para metais



208



330 mm € 16,53 5 208

Folha SANDFLEX para serrote de ponta 321



321

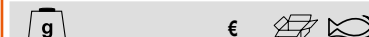

330 g € 35,64 5 321

Serra universal



210



360 g € 31,80 10 210

Mini-serrote p/metal Júnior



268

L	€	Icon 1	Icon 2
150 mm	13,18	5	268

Folha de substituição para mini-serrote



228

L	€	Icon 1	Icon 2
150 mm	11,49	80	228
150 mm	10,46	5	228-BULK

ARMAÇÃO DE SERROTE

Folha para corte de chapa e tubos de ventilação



3806-SPIRO

L	T ₁	€	Icon 1	Icon 2
600 mm	32	26,16	10	3806-600-32

Mini-serrote p/metal Júnior



239

L	€	Icon 1	Icon 2
260 mm	5,81	150	239

Mini-serrote p/metal Júnior



219

L	€	Icon 1	Icon 2
291 mm	5,40	120	219

Folhas de serrote manual - para metais.
Nova SANDFLEX Bi-metal + Cobalto



Mini-serrote p/metal Júnior



238

L	€	Icon 1	Icon 2
150 mm	11,71	60	238

Mini-serrote p/metal Júnior



218

L	€	Icon 1	Icon 2
235 mm	4,14	10	218
235 mm	2,88	150	218-BULK

3906

L	T ₁	€	Icon 1	Icon 2
250 mm	18	1,93	100	3906-250-18-100
250 mm	24	1,93	100	3906-250-24-100
250 mm	32	1,93	100	3906-250-32-100
300 mm	14	2,17	100	3906-300-14-100
300 mm	18	2,17	100	3906-300-18-100
300 mm	24	2,17	100	3906-300-24-100
300 mm	32	2,17	100	3906-300-32-100
300 mm	18-28	2,30	100	3818-300-PROG-100
300 mm	14	33,86	10	3906-300-14-10P
300 mm	18	21,68	10	3906-300-18-10P
300 mm	24	27,59	10	3906-300-24-10P
300 mm	32	27,59	10	3906-300-32-10P
250 mm	18	10,17	10	3906-250-18-5P
250 mm	24	10,17	10	3906-250-24-5P
250 mm	32	10,17	10	3906-250-32-5P
300 mm	14	11,45	10	3906-300-14-5P
300 mm	18	14,05	10	3906-300-18-5P
300 mm	24	14,05	10	3906-300-24-5P
300 mm	32	14,05	10	3906-300-32-5P
300 mm	18-28	14,44	10	3818-300-PROG-5P
300 mm	18/24/32	8,70	10	3906-300-3P
300 mm	18	5,99	10	3906-300-18-2P
300 mm	24	5,99	10	3906-300-24-2P
300 mm	32	5,99	10	3906-300-32-2P

Nova SANDFLEX Bi-metal + Cobalto



Folhas de serrote manual - para metais.
HSS



3905

L	mm	€	Q	Ref
250 mm	24	2,20	100	3905-250-24-100
300 mm	14	2,30	100	3905-300-14-100
300 mm	18	2,30	100	3905-300-18-100
300 mm	24	2,30	100	3905-300-24-100
300 mm	32	2,15	100	3905-300-32-100
300 mm	24	5,99	10	3905-300-24-2P

HSS

Lâmina para serrote junior



228-P

L	mm	€	Q	Ref
150 mm	15	4,14	10	228-15-5P
150 mm	32	4,14	10	228-32-5P
150 mm	32	4,90	10	228-32-10P
150 mm	32	28,68	1	228-32-100P

Folha revestida com carboneto de tungsténio



3816

L	mm	€	Q	Ref
300 mm	12	12,83	50	3816-300

Folha revestida com carboneto de tungsténio



216-R

L	mm	€	Q	Ref
150 mm	20	7,02	1	216-150-R
300 mm	20	10,34	1	216-300-R

Folha de substituição p/ mini-serrote. For juniorbaufiler



215

L	mm	€	Q	Ref
150 mm	110	7,02	1	215-150

For juniorbaufiler

Folhas para serrote de ponta. Para serrote de ponta 321



321-SB

L	mm	€	Q	Ref
310 mm	7	17,81	10	321-7-SB
310 mm	18	18,99	10	321-18-SB
310 mm	24	19,30	10	321-24-SB

Para serrote de ponta 321



Serrote



SERROTES PARA MATERIAL DE CONSTRUÇÃO

Serrote para uso geral - dente temperado



PC-GNP

		€		
375 mm	15/16	28,50	4	PC-15-GNP

Serrote de ponta - dente temperado



NP-COM

		€		
300 mm	7/8	15,41	4	NP-12-COM

Serrote para gesso - dente temperado



PC-PLS

		€		
600 mm	7/8	36,93	4	PC-24-PLS

Folha de serrote Superior Universal



EX-16-GNP-C

		€		
400 mm	15/16	32,11	10	EX-16-GNP-C

Serrote de ponta - dente temperado



PC-COM

		€		
300 mm	9/10	21,57	4	PC-12-COM

Folha de serrote Superior Pladur



EX-22-PLS-C

		€		
550 mm	7/8	40,34	10	EX-22-PLS-C

Serrote de ponta Superior - dente temperado



3150

		€		
300 mm	9/10	35,66	4	3150-12-XT9-HP

Serrote de ponta - Pladur



PC-6-DRY

		€		
160 mm	8	22,95	6	PC-6-DRY

Serrote para cortar todo o tipo de materiais plásticos



PC-22-PLC

		€		
550 mm	11/12	31,17	4	PC-22-PLC

Serrote para poliestireno - dente temperado



PC-DECO

		€		
400 mm	18/19	28,50	4	PC-16-DECO

Serrote para betão leve - dente temperado



256

		€		
650 mm	2	69,39	4	256-26

Serrote para uso geral - dente temperado



300

		€		
350 mm	15/16	20,02	4	300-14-F15/16-HP

Serrote para o corte de betão leve e blocos LEKA



255-34

		€		
620 mm	1,3	64,84	2	255-34

Serrote para material isolador. PC-22-INS-10P/24P: com 10/24pcs



PC-22-INS

		€		
550 mm	WT	31,02	4	PC-22-INS

PC-22-INS-10P/24P: com 10/24pcs

Serrote hobby



369

		€		
360 mm	13/14	19,55	20	369-BLADE

Serrote para o corte de betão leve e blocos LEKA



255-17/34

		€		
620 mm	0.6	56,84	2	255-17/34

Serrote dobrável especialmente desenvolvido para cortar material de lã de isolamento



396-INS

		€		
190 mm	WT	25,96	10	396-INS

Serrote - dente temperado



NP

		€		
400 mm	7/8	14,52	4	NP-16-U7/8-HP
475 mm	7/8	14,52	10	NP-19-U7/8-HP
550 mm	7/8	15,51	10	NP-22-U7/8-HP

SERROTOS PARA MADEIRA



Lâmina Serrote BHS. PrizeCut



EX-NPP-22

		€		
550 mm	7/8	18,90	10	EX-NPP-22

PrizeCut

Lâmina Serrote BHS. PrizeCut



EX-22-U7

		€		
550 mm	7/8	15,49	10	EX-22-U7

PrizeCut

Serrote Caixa Ferramenta Superior. Para material médio e fino



ergo



2600-16

		€		
400 mm	11/12	56,58	4	2600-16-XT11-HP

Para material médio e fino

Folha de serrote Superior Médio



EX-XT9

		€		
475 mm	9/10	42,70	10	EX-19-XT9-C
550 mm	9/10	44,19	10	EX-22-XT9-C

Serrote - dente temperado



PC-GT7

		€		
475 mm	7/8	29,16	4	PC-19-GT7
550 mm	7/8	30,48	4	PC-22-GT7

Serrote de costas Superior - dente temperado



ergo



3180

		€		
350 mm	11/12	50,20	4	3180-14-XT11-HP

Serrote - Corte cruzado



NP-FLEEM

		€		
550 mm	7	15,83	10	NP-22-F7/8-HP

Serrote - dente reafiável



PC-FILE

		€		
400 mm	7/8	19,34	4	PC-16-FILE-U7
475 mm	7/8	20,68	4	PC-19-FILE-U7
550 mm	7/8	22,00	4	PC-22-FILE-U7
600 mm	7/8	31,46	4	PC-24-FILE-U7

Serrote de sambrar Superior - dente temperado



ergo



3240

		€		
350 mm	11/12	42,34	4	3240-14-XT11-HP

Serrote Profissional Superior- dente temperado



ergo®



2600

Comprimento	Arredondado	€	Quantidade	Modelo
475 mm	9/10	58,75	4	2600-19-XT-HP
550 mm	9/10	60,55	4	2600-22-XT-HP



Serrote para madeira grossa



244

Comprimento	Arredondado	€	Quantidade	Modelo
500 mm	7/8	24,44	10	244-20-U7/8-HP
550 mm	7/8	25,42	10	244-22-U7/8-HP



Folha de serrote Superior Fino



EX-20-XT11-C

Comprimento	Arredondado	€	Quantidade	Modelo
500 mm	11/12	44,19	10	EX-20-XT11-C



Serrote - dente temperado



2500 XT

Comprimento	Arredondado	€	Quantidade	Modelo
400 mm	11/12	44,19	4	2500-16-XT-HP
475 mm	9/10	45,55	4	2500-19-XT-HP
550 mm	9/10	46,88	4	2500-22-XT-HP
600 mm	7/8	48,72	4	2500-24-XT7-HP



Folha de serrote Superior Laminado



EX-20-LAM-C

Comprimento	Arredondado	€	Quantidade	Modelo
500 mm	11/12	45,13	10	EX-20-LAM-C



Folha de serrote de costas Superior



EX-14-TEN-C

Comprimento	Arredondado	€	Quantidade	Modelo
350 mm	11/12	36,62	5	EX-14-TEN-C



Serrote Profissional Superior. Para madeira média e fina.



ergo®



3090

Comprimento	Arredondado	€	Quantidade	Modelo
500 mm	11/12	55,49	4	3090-20-XT11-HP



Serrote para chãos de madeira e laminados. Dente temperado



PC-LAM

Comprimento	Arredondado	€	Quantidade	Modelo
500 mm	11/12	31,83	4	PC-20-LAM



Dente temperado

Serrote Superior para madeira e laminados. Dente temperado



SUP-LAM

Comprimento	Arredondado	€	Quantidade	Modelo
500 mm	11/12	56,65	4	SUP-20-LAM



Dente temperado

Folha de serrote de sambrar Superior



EX-14-VEN-C

Comprimento	Arredondado	€	Quantidade	Modelo
350 mm	11/12	30,83	10	EX-14-VEN-C



Para madeira média e fina.



Serrote - dente temperado



PC-GT9

Comprimento	Dente	Preço	Quantidade	Modelo
475 mm	9/10	29,16	4	PC-19-GT9
550 mm	9/10	30,48	4	PC-22-GT9

Serrote de sambrar - dente temperado



PC-VEN

Comprimento	Dente	Preço	Quantidade	Modelo
300 mm	11/12	33,61	4	PC-12-VEN

Serrote de costas - dente temperado



NP-VEN

Comprimento	Dente	Preço	Quantidade	Modelo
300 mm	13/14	18,92	10	NP-12-VEN

Serrote para caixa de ferramentas. Dente temperado



PC-TBX

Comprimento	Dente	Preço	Quantidade	Modelo
375 mm	11/12	27,49	4	PC-15-TBX

Dente temperado

Serrote de precisão - dente temperado



PC-PRC

Comprimento	Dente	Preço	Quantidade	Modelo
500 mm	9/10	48,19	4	PC-20-PRC

Folha de serrote Superior



EX-XT7

Comprimento	Dente	Preço	Quantidade	Modelo
550 mm	7/8	44,19	10	EX-22-XT7-C
600 mm	7/8	45,75	10	EX-24-XT7-C

Serrote de costas - dente temperado



PC-TEN

Comprimento	Dente	Preço	Quantidade	Modelo
300 mm	11/12	31,07	4	PC-12-TEN

Serrote de costas - dente temperado



NP-TEN

Comprimento	Dente	Preço	Quantidade	Modelo
300 mm	13/14	18,09	10	NP-12-TEN

Lâmina para Serrote BHS. Barracuda



EX-244P-22

Comprimento	Dente	Preço	Quantidade	Modelo
550 mm	7/8	23,09	10	EX-244P-22

Barracuda

Serrote para madeira tamanho médio



244P

Comprimento	Dente	€	Quantidade	Modelo
500 mm	7/8	27,49	4	244P-20-U7-HP
550 mm	7/8	28,55	10	244P-22-U7-HP



Esquadrias em madeira



233

Dimensões	€	Quantidade	Modelo
65 x 135 x 300 mm	18,87	5	233-300
75 x 135 x 300 mm	25,86	5	233-300-A
65 x 135 x 400 mm	27,51	5	233-400



SERRAS MANUAIS DE PRECISÃO

Serrote de sambrar



PC-12-PS

Comprimento	Dente	€	Quantidade	Modelo
305 mm	13.5	41,58	4	PC-12-14-PS
305 mm	13.5	29,00	10	PC-12-14-PS-B



Serrote Profissional Superior - dente temperado



2700

Comprimento	Dente	€	Quantidade	Modelo
550 mm	7/8	61,71	4	2700-22-XT7-HP
600 mm	7/8	62,60	4	2700-24-XT7-HP



Esquadrias em madeira



234-W

Dimensões	€	Quantidade	Modelo
53 x 77 x 245 mm	8,72	10	234-W1
63 x 95 x 300 mm	10,86	10	234-W2
80 x 100 x 300 mm	14,04	10	234-W3



Serrote de sambrar



PC-11-PS

Comprimento	Dente	€	Quantidade	Modelo
270 mm	18.5	45,87	4	PC-11-19-PS
270 mm	18.5	31,31	10	PC-11-19-PS-B



Serrote para madeira de construção. Dente reafiável



PC-TIM

Comprimento	Dente	€	Quantidade	Modelo
600 mm	3.5/4.5	49,68	4	PC-24-TIM



Esquadria em alumínio

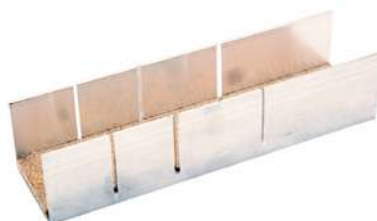

234-A

Dimensões	€	Quantidade	Modelo
55 x 65 x 245 mm	20,52	1	234-A1
40 x 106 x 245 mm	21,67	1	234-A2



Serra de corte duplo



PC-9-PS

Comprimento	Dente	€	Quantidade	Modelo
240 mm	6-8.5 / 17	42,15	4	PC-9-9/17-PS
240 mm	6-8.5 / 17	31,58	10	PC-9-9/17-PS-B



Dente reafiável



Serrote hobby - cabo à direita



PC-DTF

		€		
250 mm	15/16	27,46	10	PC-10-DTF



PUNHOS E AMOLADORES

Handsägegriff, L=Groß, M=Mittel. RI mão direita



ergo®



EX-

	€		
120 x 330 x 60 mm	39,56	4	EX-LL
120 x 330 x 60 mm	39,56	4	EX-RM
120 x 330 x 60 mm	39,56	4	EX-RL



RI mão direita

Serrote de rodear



502

	€		
130 mm	10,03	25	502



Serrote hobby - cabo à direita



PC-DTR

		€		
250 mm	15/16	17,96	10	PC-10-DTR



Afiador HSS



SHARP-INS

	€		
206 mm	10,80	100	SHARP-INS



Jogo de Serrote de rodear, 2 peças



502-SET2

		€		
2	130 g	5,82	35	502-SET2



Serrote hobby - cabo à esquerda



PC-DTL

		€		
250 mm	15/16	17,96	10	PC-10-DTL



Serrote de rodear



302

	€		
130 mm	18,37	30	302



Jogo de Serrote de rodear, 6 peças



502-SET6

		€		
6	500 g	26,06	10	502-SET6

Conjunto de lâminas de substituição o.
Para serrote de rodear - madeira, metais
e plástico



302-6X4P



L	€		
130 mm	10,01	1	302-6X4P

Para serrote de rodear - madeira, metais e plástico

Lame per traforo - metallo. 1: fijn, 3-5:
medium, 7: grof



302M



L	€		
1 130 mm	5,22	1	302-71M-12P
3 130 mm	5,23	1	302-73M-12P
5 130 mm	6,29	1	302-75M-12P
7 130 mm	6,80	1	302-77M-12P

1: fijn, 3-5: medium, 7: grof

Lâmina de substituição. 3:medium og
5:grof



302S



L	€		
1 130 mm	4,44	1	302-81S-12P
3 130 mm	4,44	1	302-83S-12P
5 130 mm	5,02	1	302-85S-12P

3:medium og 5:grof

Lame per traforo - legno. 1-3: fein, 5-7:
mittel, 9-11: grob



302W



L	€		
1 130 mm	3,14	1	302-51W-12P
3 130 mm	3,14	1	302-53W-12P
5 130 mm	3,14	1	302-55W-12P
7 130 mm	3,71	1	302-57W-12P
9 130 mm	4,21	1	302-59W-12P
11 130 mm	4,56	1	302-511W-12P

1-3: fein, 5-7: mittel, 9-11: grob

SERROTE MUSICAL

Serrote Musical



296

L	€		
750 mm	151,32	1	296

SERRAS E LÂMINAS PARA SERRAS

Serrote de rodear



301



L	€		
165 mm	18,81	50	301

Lâmina Substituição para serrote 301

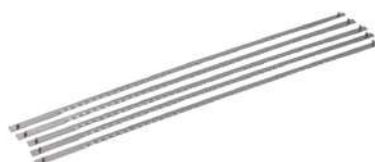

303



L	€		
165 mm	5,05	10	303-5P



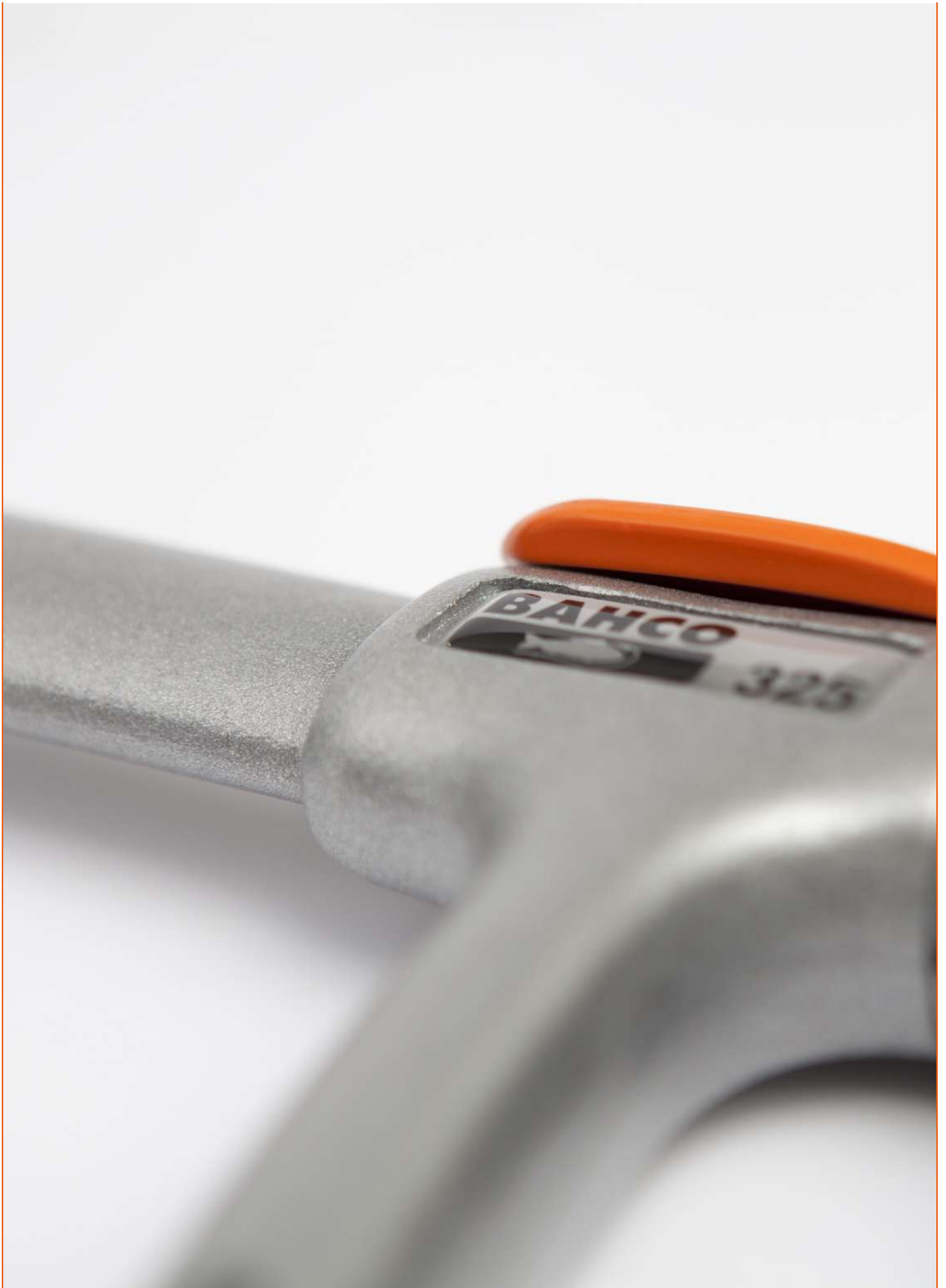

BAHCO



Formões para madeira



FORMÕES DE MARCENARIA

Formões ERGO™ - Carpintaria e construção



ergo



434

	€		
6 mm	22,84	4	434-6
8 mm	23,56	4	434-8
10 mm	23,94	4	434-10
12 mm	24,51	4	434-12
14 mm	25,08	4	434-14
15 mm	25,34	4	434-15
16 mm	25,77	4	434-16
18 mm	26,19	4	434-18
20 mm	26,73	4	434-20
22 mm	27,43	4	434-22
25 mm	28,13	4	434-25
28 mm	29,14	4	434-28
30 mm	29,56	4	434-30
32 mm	30,12	4	434-32
35 mm	30,94	4	434-35
38 mm	31,93	4	434-38
50 mm	36,65	4	434-50

Jogo de formões



ergo



434-S3-EUR

	€		
3	78,84	1	434-S3-EUR

434-12, 434-18, 434-25

Conjunto de cinzel à prova de fendas ERGO™ em bolsa de rolo de couro - 6 peças



ergo



434-S6-LR

	€		
6	175,73	1	434-S6-LR

434-6, 434-10, 434-12, 434-18, 434-25, 434-32

Conjunto de formões: 6peças



ergo



434-S6-EUR

	€		
6	156,01	1	434-S6-EUR

434-6, 434-10, 434-12, 434-18, 434-25, 434-32

Conjunto de formões: 8 peças



ergo



434-S8-EUR

	€		
8	178,18	1	434-S8-EUR

434-6, 434-10, 434-12, 434-16, 434-18, 434-25, 434-32, 434-38

CONJUNTO DE FORMÕES PARA MADEIRA, 6 peças



ergo



434-S6-PP

	€		
6	158,05	1	434-S6-PP

434-6, 434-10, 434-12, 434-18, 434-25, 434-32

Formões - Carpintaria em geral



424P

	€		
4 mm	17,75	4	424P-4
6 mm	18,20	4	424P-6
8 mm	18,65	4	424P-8
10 mm	19,10	4	424P-10
12 mm	19,55	4	424P-12
14 mm	20,01	4	424P-14
15 mm	20,22	4	424P-15
16 mm	20,46	4	424P-16
18 mm	20,91	4	424P-18
20 mm	21,36	4	424P-20
22 mm	21,80	4	424P-22
24 mm	22,26	4	424P-24
25 mm	22,46	4	424P-25
26 mm	22,71	4	424P-26
28 mm	23,17	4	424P-28
30 mm	23,62	4	424P-30
32 mm	24,06	4	424P-32
35 mm	24,74	4	424P-35
38 mm	25,42	4	424P-38
40 mm	25,87	4	424P-40

Conjunto de formões: 3peças



424P-S3-EUR

	€		
3	62,95	1	424P-S3-EUR

424P-12, 424P-18, 424P-25

Cinzel profissional de 2 componentes em bolsa de rolo de couro - 6 peças



424P-S6-LR

	€		
6	137,66	1	424P-S6-LR

424P-6, 424P-10, 424P-12, 424P-18, 424P-25, 424P-32

Jogo de formões



424P-S6-EUR

	€		
6	144,69	1	424P-S6-EUR

424P-6, 424P-10, 424P-12, 424P-18, 424P-25, 424P-32

CONJUNTO DE FORMÕES PARA MADEIRA, 6 peças



424P-S6-PP

	€		
6	97,98	1	424P-S6-PP

424P-6, 424P-10, 424P-12, 424P-18, 424P-25, 424P-32

	€		
10 mm	26,68	5	1031-10
12 mm	27,37	5	1031-12
14 mm	27,91	5	1031-14
16 mm	28,45	5	1031-16
18 mm	29,12	5	1031-18
20 mm	29,81	5	1031-20
22 mm	30,46	5	1031-22
25 mm	31,28	5	1031-25
28 mm	32,23	5	1031-28
30 mm	32,88	5	1031-30
32 mm	33,57	5	1031-32
40 mm	35,99	5	1031-40

Conjunto de formões



424P-S6-GER

	€		
6	134,56	1	424P-S6-GER

424P-6, 424P-10, 424P-12, 424P-16, 424P-20, 424P-26

Formões - Uso em geral



414

	€		
6 mm	15,25	4	414-6
8 mm	15,60	4	414-8
10 mm	15,42	4	414-10
12 mm	16,44	4	414-12
14 mm	16,77	4	414-14
15 mm	16,91	4	414-15
16 mm	17,10	4	414-16
18 mm	17,56	4	414-18
20 mm	17,89	4	414-20
22 mm	18,35	4	414-22
25 mm	18,84	4	414-25
28 mm	19,48	4	414-28
30 mm	19,79	4	414-30
32 mm	20,12	4	414-32
35 mm	20,75	4	414-35
38 mm	21,23	4	414-38

Jogo de formões



414-S3-EUR

	€		
3	52,83	1	414-S3-EUR

414-12, 414-18, 414-25

Conjunto de talhadeira



424P-S8-EUR

	€		
8	197,31	1	424P-S8-EUR

424P-6, 424P-10, 424P-12, 424P-16, 424P-18, 424P-25, 424P-32, 424P-38

Formões



1031

	€		
4 mm	24,80	5	1031-4
6 mm	25,35	5	1031-6
8 mm	25,88	5	1031-8

Jogo de formões



9883

	€		
5	142,23	1	9883

1031-6, 1031-12, 1031-16, 1031-20, 1031-25



Formões - Cabo em madeira



425

	€		
4 mm	13,51	4	425-4
6 mm	14,01	4	425-6
8 mm	14,21	4	425-8
10 mm	14,54	4	425-10
12 mm	14,89	4	425-12
14 mm	15,23	4	425-14
15 mm	15,41	4	425-15
16 mm	15,58	4	425-16
18 mm	15,94	4	425-18
20 mm	16,27	4	425-20
22 mm	16,60	4	425-22
24 mm	16,97	4	425-24
25 mm	17,13	4	425-25
26 mm	17,30	4	425-26
28 mm	17,64	4	425-28
30 mm	18,01	4	425-30
32 mm	18,32	4	425-32
35 mm	18,86	4	425-35
38 mm	19,40	4	425-38
40 mm	19,69	4	425-40

Jogo de formões cabo madeira



425-081

	€		
3	47,95	1	425-081

425-12, 425-18, 425-25

Conjunto de talhadeira - cabo de madeira



425-082

	€		
5	76,39	1	425-082

425-6, 425-10, 425-12, 425-18, 425-25

Conjunto de formões: 6peças



425-083

	€		
6	100,87	1	425-083

425-6, 425-10, 425-12, 425-18, 425-25, 425-32

Cabo de substituição Formões



956

	g	€		
108 mm	50 g	5,42	1	956

GOIVAS

Goiva - Carpintaria em geral



422P

	€		
6 mm	36,41	4	422P-6
10 mm	36,86	4	422P-10
12 mm	36,86	4	422P-12
16 mm	36,86	4	422P-16
20 mm	39,06	4	422P-20
25 mm	46,40	4	422P-25

FORMÕES DE DEMOLIÇÃO

Faca Formão. SB-2448 embalado, 2448
Caixa expositora 12 Divisão permitida
NÃO



2448

	L	€		
25 mm	231 mm	29,91	12	2448
25 mm	240 mm	30,67	12	SB-2448

SB-2448 embalado, 2448 Caixa expositora 12 Divisão permitida NÃO

Formão/Faca II. SB: blister, 2449
exposição de 12 peças



2449

	L	€		
25 mm	235 mm	27,49	12	2449
25 mm	235 mm	27,49	10	SB-2449

SB: blister, 2449 exposição de 12 peças

ACESSÓRIOS PARA FORMÕES DE MADEIRA

Pedra de afiar natural - fina



528-700



150 mm

€

48,52



1 528-700

Bloco de amolar



SBC110



30 x 65 x 110 mm



67 g

€

2,49



1 SBC110-65

Pedra de afiar artificial - face grossa + face fina



528-COM



150 mm

€

40,60



1 528-COM

Lâmina de substituição plana para esmerilar



BP-40-95



112 mm



55 g

€

3,85



12 BP-40-95

Plaina de moagem



BP-40



160 mm

€

49,13



1 BP-40

Bolsa de plástico de proteção



WC-HOL



292 mm

€

4,13



1 WC-HOL





BAHCO



Tesouras e facas



TESOURAS PARA METAL

Alicate corte chapa, corte recto



MA421

	€		
250 mm	29,61	10	MA421

Alicate corte chapas, corte longo



MA431

	€		
290 mm	32,48	1	MA431

Alicate corte de chapas, corte direita



MA411

	€		
250 mm	29,61	10	MA411

Alicate corte chapa profissional c/
Alavanca, corte direita



MA321

	€		
260 mm	38,66	10	MA321

Alicate para Corte Chapas, corte esquerdo



MA401

	€		
250 mm	29,61	10	MA401

Alicate corte chapa profissional, corte
esquerdo



MA311

	€		
260 mm	38,66	1	MA311

Tesoura para corte chapa. Corte direito



MA225

	€		
250 mm	48,99	4	MA225

Corte direito

Tesoura para corte chapa. Para corte
direito e contornos à direita



MA225R

	€		
250 mm	51,01	4	MA225R

Para corte direito e contornos à direita

Tesoura para corte chapa. Para corte
esquerdo e contornos à esquerda



MA225L

	€		
250 mm	51,01	4	MA225L

Para corte esquerdo e contornos à esquerda

Alicate corte chapa profissional, corte direito



MA361

	€		
260 mm	43,30	10	MA361

Tesoura para corte chapa industrial. Corte direito



MR340

	€		
340 mm	92,78	2	MR340

Corte direito

Tesoura para corte chapa industrial. Corte direito e à direita



585D

	€		
280 mm	84,55	4	585D

Corte direito e à direita

Alicate corte chapa profissional, corte esquerdo



MA351

	€		
250 mm	43,30	10	MA351

Tesoura para corte chapa industrial. Corte direito e à direita



583D

	€		
280 mm	87,80	4	583D

Corte direito e à direita

Tesoura para corte chapa industrial. Corte direito e à esquerda



586D

	€		
280 mm	82,17	4	586D

Corte direito e à esquerda

Tesoura para corte chapa. Corte direito



MA325

	€		
250 mm	58,76	4	MA325

Corte direito

Tesoura para corte chapa industrial. Corte direito e à direita



584D

	€		
280 mm	84,63	4	584D

Corte direito e à direita

Tesoura para corte chapa industrial. Corte direito e à esquerda



M227L

	€		
270 mm	36,92	4	M227L

Corte direito e à esquerda



Tesoura para corte chapa industrial. Corte direito e à direita



M227R

	€		
270 mm	36,92	4	M227R

Corte direito e à direita

Tesoura corte chapa. Corte direito



8691

	€		
255 mm	31,58	6	869102500
300 mm	39,62	6	869103000

Corte direito

Tesoura para corte chapa industrial. Corte direito e à direita



MR227R

	€		
270 mm	45,55	4	MR227R

Corte direito e à direita

Tesoura para corte chapa industrial. Corte direito



M330

	€		
11 3/4 mm	72,01	4	M330

Corte direito

Tesoura de corte de chapa, tipo Catalónia



8692

	€		
300 mm	30,35	6	869203000

Tesoura de dois braços



M6376

	€		
760 mm	293,24	1	M6376
	125,67	1	M6376-SH

Tesoura para corte chapa industrial. 2 brede skjør



M526

	€		
260 mm	37,32	4	M526

2 brede skjør

Tesoura para corte chapa industrial. Corte direito e à esquerda



MR227L

	€		
270 mm	45,96	4	MR227L

Corte direito e à esquerda

Tesoura de dois braços



M676

	€		
760 mm	283,73	1	M676
	125,44	1	M676-SH

Tesoura roedora



M926

	€		
250 mm	82,93	1	M926
	18,33	1	M926-SH

Tesoura de electricista resistente ranhurada



SCB140G

		€		
43 mm	140 mm	29,12	10	SCB140G

Tesoura de Electricista plastificada.



SC150NG

		€		
38 mm	155 mm	18,74	10	SC150NG

Tesoura multi-funções



2744

	€		
190 mm	21,88	6	2744

Tesoura de Electricista plastificada..
S=versão serrilhada



SC127/SC127S

		€		
45 mm	130 mm	12,83	10	SC127
45 mm	127 mm	13,24	10	SC127S

S=versão serrilhada

Tesoura especial pequena



2704

	€		
110 mm	35,54	1	2704A

TESOURAS

Tesoura de electricista resistente



SCB140

		€		
43 mm	140 mm	26,53	10	SCB140

Tesoura de Electricista plastificada..
c=versão curva



SC140/SC140C

		€		
50 mm	145 mm	13,49	10	SC140
50 mm	145 mm	14,14	10	SC140C

c=versão curva

Fôrceps



2705R

	€		
160 mm	30,73	1	2705R



FACAS

Faca retrátil ERGO™



ergo



KERU01

		€		
170 mm	26 mm	20,87	5	KERU-01

Faca universal ERGO™



ergo



KEFU-01

		€		
170 mm	26 mm	18,77	5	KEFU-01

X-ATO ERGO™ 18mm



ergo



KE18-01

		€		
161 mm	26 mm	16,00	5	KE18-01

Faca retrátil



KBRU-01

		€		
170 mm	26 mm	18,01	5	KBRU-01

Faca retrátil



KGRU-01

		€		
160 mm	26 mm	12,85	5	KGRU-01

Faca retrátil



KGRU-02

		€		
145 mm	26 mm	11,43	5	KGRU-02

Faca retrátil mini



KMU-01

		€		
90 mm	26 mm	8,58	5	KMU-01

X-Acto



SQZ150003

		€		
170 mm	60 mm	24,11	6	SQZ150003

Faca universal



KBFU-01

		€		
170 mm	26 mm	16,21	5	KBFU-01

Faca universal



KGFU-01

		€		
160 mm	26 mm	11,57	5	KGFU-01

Lâminas faca retrátil



KBGU

	€		
0.635 x 19 x 60 mm	32,60	1	KBGU-100P

Distribuidor de 5 unidades de lâminas de gancho



KBGH-5P-DISPEN

	€		
0.635 x 19 x 51 mm	3,42	20	KBGH-5P-DISPEN

X-ATO 9mm



KB09-01

	€		
140 mm	8,58	5	KB09-01

Distribuidor de 5 unidades de lâminas trapezoidais



KBGU-5P-DISPEN

	€		
0.635 x 19 x 60 mm	2,93	20	KBGU-5P-DISPEN

Lâminas segurança p/faca universal em distribuidor de 5 udds



KBGR-5P-DISPEN

	€		
0.635 x 19 x 55 mm	4,69	20	KBGR-5P-DISPEN

X-ATO 18mm



KB18-01

	€		
160 mm	10,87	5	KB18-01

Distribuidor de 10 unidades de lâminas trapezoidais



KBGU-10P-DISPEN

	€		
0.635 x 19 x 60 mm	5,05	20	KBGU-10P-DISPEN

Lâminas de Substituição para faca Universal



SQZ150003-HSBL

	€		
51 mm	14,36	6	SQZ150003-HSBL

X-ATO 9mm



KG09-01

	€		
140 mm	6,15	5	KG09-01
140 mm	18,44	10	KG09-01-3P



X-ATO 18mm



KG18-01



160 mm

€

7,99



5 KG18-01

Distribuidor de 5 unidades, de lâminas de quebrar de 18 mm



KUBG18-5DISPEN



15 x 30 x 130 mm

€

4,19



20 KUBG18-5DISPEN

Estojo de faca universal fixa



KHU-01



90 g

€

4,82



4 KHU-01

Distribuidor de 10 unidades, de lâminas de quebrar de 9 mm



KSBG09-10DISPEN



1 x 9 x 85 mm

€

4,50



20 KSBG09-10DISPEN

Distribuidor de 10 unidades de lâminas de quebrar com 18 mm



KSBG18-10DISPEN



15 x 30 x 130 mm

€

5,88



20 KSBG18-10DISPEN

Mini x-ato universal



SQZ-MINI



160 mm

€

9,72



24 SQZ-MINI

Lâmina X-ATO



KUBG



0,7 x 85 x 9 mm

€

3,05



20 KUBG09-5P

Faca de segurança



KGAU-01



160 mm

€

16,40



5 KGAU-01

Distribuidor de lâminas de mini x-ato



SQZ-MINI-BLADE



28 mm

€

5,22



1 SQZ-MINI-BLADE

BAHCO

Faca dupla lâmina



KBTU-01

€  
31,44 5 KBTU-01

Canivete com fecho de lâmina







KGSU-01

€  
15,43 5 KGSU-01

Facas de aço inoxidável multiusos para comerciantes com cabo de componente duplo - 15 unidades/exposição de balcão



2446-BL

  €  
218 mm 102 mm 9,37 15 2446-BL

Canivete



KBSK-01

€  
20,01 5 KBSK-01

Facas Laplander com cabo verde de componente duplo



2446-LAP

  €  
218 mm 102 mm 8,34 15 2446-LAP
218 mm 102 mm 10,30 10 SB2446-LAP

Facas multiusos com pega de dois componentes e ponta cega de segurança



2446-SAFE

  €  
215 mm 95 mm 9,13 15 2446-SAFE

Canivete com fecho de lâmina







KBSU-01

€  
20,01 5 KBSU-01

Faca robusta com lâmina em inox para vários fins



2446

  €  
225 mm 100 mm 11,09 15 2446

Faca para linóleo



2446-LINO

  €  
180 mm 55 mm 8,72 12 2446-LINO



Faca de decapagem para electricista com uso de ambas as mãos



2446-EL

		€		
32 mm	150 mm	9,38	12	2446-EL

Facas de decapagem para electricista - utilização por destros. Utilização por destros



2446-ELR

		€		
34 mm	145 mm	9,38	12	2446-ELR

Faca robusta com lâmina em inox para vários fins



1446

		€		
220 mm	100 mm	7,15	15	1446

Faca de decapagem para electricista com uso de ambas as mãos



SB2446-EL

		€		
150 mm	32 mm	9,72	10	SB2446-EL

Faca robusta multiusos com uma lâmina sólida em aço inox



2446-OV

		€		
220 mm	100 mm	11,09	15	2446-OV

Facas multiusos em aço-carbono para comerciantes com cabo de componente único - 15 unidades/expositor de balcão



1446-CS

		€		
218 mm	102 mm	7,50	15	1446-CS

Facas de decapagem para electricista - utilização por canhotos. Utilização por destros



2446-ELL

		€		
34 mm	145 mm	9,38	12	2446-ELL

FACA DE ELETRICISTA COM GUIA



2446-EL-HELP

	€		
43 mm	10,25	12	2446-EL-HELP

Faca flutuante com pega fluorescente



1446-FLOAT

		€		
226 mm	102 mm	12,32	15	1446-FLOAT

Faca flutuante com cabo fluorescente



1446-FLOAT-B

		€		
225 mm	100 mm	6,49	12	1446-FLOAT-B

Balde para facas 1446-CS



BUCKET-1446-CS

	€		
25 l	646,84	1	BUCKET - 1446-CS

Faca de aperto de electricista



2820EK-01

		€		
25 mm	130 mm	6,02	12	2820EK-01

Balde para facas 1446



BUCKET 1446

	€		
25 l	8,36	75	BUCKET 1446

BUCKET - EMPTY

1446-CSx 75	

Balde para facas 1446-FLOAT



BUCKET-1446-FLOAT

	€		
25 l	796,14	1	BUCKET-1446-FLOAT

BUCKET - EMPTY

1446-FLOATx 75	

Balde vazio



BUCKET-EMPTY

	€		
25 l	16,48	6	BUCKET - EMPTY

Faca robusta multiusos com uma lâmina sólida em aço inox. Estojo especial para transporte e armazenamento seguro



1446-OV

		€		
225 mm	100 mm	11,84	15	1446-OV

Faca para Electricista



2820EK

		€		
95 mm	205 mm	7,68	6	2820EK

Navalha para Electricista



2820EF1

		€		
90 mm	200 mm	9,58	12	2820EF1



Navalha para Electricista



2820EF2

		€		
85 mm	195 mm	12,32	8	2820EF2

Canivete multi-funções



MTT151

	€		
150 mm	42,10	6	MTT151

2 peças de plástico do raspador de janela



KRSS-01

	€		
80 g	6,71	10	KRSS-01

Navalha para Electricista



2820EF3

		€		
80 mm	170 mm	15,95	1	2820EF3

Mini canivete multifunções com porta-chaves



MTT121

	€		
110 mm	20,51	8	MTT121

2 peças de plástico do raspador de janela



KBWS-01

	€		
70 g	6,02	10	KBWS-01

Navalha para Electricista. 2 Lâminas



2820EF4

		€		
75-85 mm	170 mm	19,93	1	2820EF4

2 Lâminas

Canivete multifunções 12 em 1 com corpo em alumínio



MTT051

	€		
165 mm	25,13	6	MTT051



Braçadeiras e tornos



BRAÇADEIRAS

Grampo Aperto Rápido. Padrão



QCB

L	€		
456 mm	31,64	6	QCB-150
606 mm	33,92	6	QCB-300
756 mm	36,22	6	QCB-450
906 mm	38,88	4	QCB-600
1206 mm	42,50	4	QCB-900
1556 mm	50,99	8	QCB-1250

Padrão

Grampo aperto rápido. Básico



QCG

L	€		
380 mm	20,99	6	QCG-150
530 mm	23,89	6	QCG-300

Básico

Grampo Aperto Rápido com Alavanca. Superior



QC

X	L	€		
1	230 mm	3,15	12	QC-115A
2	230 mm	6,28	6	QC-115A-2P
1	305 mm	7,08	6	QC-150A
2	305 mm	14,17	6	QC-150A-2P
1	475 mm	11,15	6	QC-300A
2	475 mm	22,30	4	QC-300A-2P

-2P: Pacote de gêmeos

Grampo



3066

L		€		
250 mm	90 mm	22,08	5	306601500
300 mm	90 mm	23,74	5	306602000
400 mm	90 mm	26,71	5	306603000
510 mm	90 mm	29,38	5	306604000

Grampos



3067

L		€		
415 mm	125 mm	28,78	5	306703000
510 mm	125 mm	31,16	5	306704000
610 mm	125 mm	33,97	5	306705000
710 mm	125 mm	36,20	5	306706000
910 mm	125 mm	41,53	5	306708000
1115 mm	125 mm	47,19	5	306710000
1310 mm	125 mm	53,11	2	306712000
1610 mm	125 mm	60,82	2	306715000

Grampos



3068

L		€		
430 mm	155 mm	51,48	5	306803000
535 mm	155 mm	54,90	5	306804000
640 mm	155 mm	58,04	2	306805000
730 mm	155 mm	60,74	2	306806000
820 mm	155 mm	66,59	2	306808000
1135 mm	155 mm	71,71	2	306810000
1335 mm	155 mm	76,09	2	306812000
1630 mm	155 mm	82,73	1	306815000
2130 mm	155 mm	90,85	1	306820000

Grampos



3069

L		€		
430 mm	225 mm	82,77	2	306903000
540 mm	225 mm	85,88	2	306904000
638 mm	225 mm	88,99	2	306905000
730 mm	225 mm	91,98	2	306906000
932 mm	225 mm	98,06	2	306908000
1130 mm	225 mm	103,99	2	306910000

Grampo de aperto com punho de plástico



420SH

L		€		
100 mm	50 mm	14,47	10	420SH-50-100
200 mm	50 mm	16,02	10	420SH-50-200
120 mm	60 mm	23,74	12	420SH-60-120
300 mm	60 mm	28,29	12	420SH-60-300
160 mm	80 mm	31,47	12	420SH-80-160
200 mm	100 mm	36,97	10	420SH-100-200
250 mm	120 mm	43,82	8	420SH-120-250
300 mm	120 mm	47,56	8	420SH-120-300
400 mm	120 mm	49,95	6	420SH-120-400
500 mm	120 mm	53,32	6	420SH-120-500
600 mm	120 mm	57,64	6	420SH-120-600
800 mm	120 mm	63,41	6	420SH-120-800
1000 mm	120 mm	67,07	6	420SH-120-1000
1250 mm	120 mm	76,20	6	420SH-120-1250
1500 mm	120 mm	79,99	6	420SH-120-1500
400 mm	140 mm	63,41	6	420SH-140-400
400 mm	175 mm	67,62	6	420SH-175-400

Grampo Mola



420SC

	g	€		
25 mm	60 g	5,72	10	420SC-25
50 mm	120 g	8,53	5	420SC-50

Torno de Bancada Redondo



6010

	€		
80 mm	239,10	1	601000800
100 mm	318,78	1	601001000
125 mm	439,07	1	601001250
150 mm	624,07	1	601001500

Jogo de mordça para torno de bancada



833P

	€		
100 mm	33,25	1	833PJ-4
125 mm	41,32	1	833PJ-5
150 / 175 mm	41,32	1	833PJ-67

TORNOS DE BANCADA

Tornos de bancada



834V

	€		
100 mm	291,57	1	834V-4
125 mm	391,80	1	834V-5
150 mm	495,07	1	834V-6
175 mm	643,88	1	834V-7

Trono de Bancada



834V-2

	€		
63 mm	126,25	1	834V-2

Alavanca para tornos de bancada 6072



6070H

	€		
100 mm	43,74	1	6070H1000
125 mm	62,25	1	6070H1250
150 mm	111,28	1	6070H1500
175 mm	143,14	1	6070H1750

Torno de Bancada Quadrado



6072

	€		
100 mm	248,11	1	607201000
125 mm	347,35	1	607201250
150 mm	446,59	1	607201500
175 mm	595,46	1	607201750

Mordças para tornos de bancada 6072



6072M

	€		
100 mm 834V-4, 607201000	29,63	1	6072M1000
150 mm 834V-6, 607201500	45,95	1	6072M1500
175 mm 834V-7, 607201750	56,70	1	6072M1750

Mordças para tornos de bancada 6010



6010M



	€		
80 mm 601000800	24,82	1	6010M0800
100 mm 601001000	25,42	1	6010M1000
125 mm 834V-5, 607201250, 601001250	37,59	1	6010M1250
150 mm 601001500	46,01	1	6010M1500



Alavanca para tornos de bancada 6010





6010H

	€		
80 mm	48,68	1	6010H0800
100 mm	57,91	1	6010H1000
125 mm	78,95	1	6010H1250
150 mm	134,26	1	6010H1500

Mordaças alumínio



833AJ

	€		
100 mm	36,92	1	833AJ-4
125 mm	38,34	1	833AJ-5
150 mm	39,91	1	833AJ-6

Mordaças para tornos de bancada 834V-2





6040M/H

	€		
63 mm	20,76	1	6040M0630

Mordaças para torno de bancada. Fibra



833FJ

	€		
100 mm	42,15	1	833FJ-4
125 mm	43,41	1	833FJ-5
150 mm	45,13	1	833FJ-6





Fibra

ACESSÓRIOS PARA TORNO DE BANCADA

Base tornos Bancada



833SB

		€		
80 mm	100 mm	61,80	1	833SB-4
100 mm	125 mm	94,31	1	833SB-5
125 mm	150 mm	108,96	1	833SB-6
150 mm	175 mm	141,46	1	833SB-7



Martelos



MARTELOS DE ORELHAS

Martelo ERGO™



ergo



529

	€		
450 g	38,64	4	529-16-L
450 g	40,72	4	529-16-XL
570 g	40,72	4	529-20-L
570 g	42,78	4	529-20-XL

Martelos de carpinteiro retos ERGO™ com pega de borracha de bimaterial



ergo



529S

	€		
450 g	39,73	4	529S-16-XL
570 g	41,74	4	529S-20-XL

Martelo de Carpinteiro



429

	€		
230 g	18,45	4	429-8
370 g	26,85	4	429-13
450 g	29,27	4	429-16
570 g	30,12	4	429-20

Martelo de Carpinteiro



428

	€		
450 g	27,36	4	428-16

Martelo de carpinteiro curvado com pega de borracha



428F

	€		
230 g	24,74	4	428F-8
370 g	27,52	4	428F-13
454 g	30,65	4	428F-16
567 g	32,62	4	428F-20
680 g	44,67	4	428F-24

Martelo de carpinteiro com pega de borracha e removedor de pregos



428S

	€		
454 g	30,65	4	428S-16
567 g	32,62	4	428S-20

Martelo de unha



427

	€		
370 g	21,09	4	427-13
680 g	32,60	4	427-24
230 g	19,15	4	427-8
450 g	29,09	4	427-16
570 g	30,08	4	427-20

Martelo de carpinteiro com removedor de pregos e cabeça polida



427S

	€		
454 g	22,45	4	427S-16
567 g	24,76	4	427S-20

Martelo de orelhas tipo espanhol



427

	€		
700 g	24,02	6	427-700

Martelo de orelhas tipo espanhol



428

	€		
700 g	31,10	6	428-700

EXTRATORES DE PREGOS

Arranca-pregos compacto com mola interna



36

	€		
220 mm	45,63	5	36

MARTELOS DE ENGENHARIA

Martelo de bola



479

	€		
230 g	18,34	6	479-08
340 g	19,56	6	479-12
450 g	22,40	6	479-16
570 g	23,98	6	479-20
800 g	25,65	6	479-24
900 g	27,70	6	479-32

Martelo de bola com pega de fibra de vidro



479F

	€		
230 g	21,22	6	479F-08
340 g	22,51	6	479F-12
450 g	25,76	6	479F-16
570 g	27,58	6	479F-20
680 g	29,50	6	479F-24
900 g	31,85	6	479F-32

Martelo para mecânico



481

	€		
100 g	12,38	6	481-100
200 g	13,89	6	481-200
300 g	16,38	6	481-300
400 g	18,10	6	481-400
500 g	20,82	6	481-500
800 g	27,77	6	481-800
1000 g	30,52	6	481-1000
1500 g	41,67	6	481-1500
2000 g	61,34	6	481-2000

Martelo alemão DIN com cabo de fibra de vidro



481F

	€		
100 g	14,24	6	481F-100
200 g	15,97	4	481F-200

	€		
300 g	18,84	6	481F-300
400 g	20,82	6	481F-400
500 g	23,94	6	481F-500
800 g	31,94	6	481F-800
1000 g	35,09	6	481F-1000
1500 g	47,92	4	481F-1500
2000 g	70,55	4	481F-2000

Martelo para mecânico



482

	€		
300 g	16,08	6	482-25
400 g	17,51	6	482-28
500 g	20,35	6	482-30
800 g	23,90	6	482-35
1000 g	26,50	6	482-40
1500 g	27,74	6	482-45

Martelo de mecânico com pega de fibra de vidro



482F

	€		
300 g	18,50	4	482F-25
400 g	20,14	4	482F-28
470 g	23,41	6	482F-30
800 g	27,49	4	482F-35
1000 g	30,47	2	482F-40
1500 g	31,89	4	482F-45



Martelo de pena



480

	€		
230 g	23,05	4	480-08
280 g	24,92	6	480-10
340 g	26,93	6	480-12
400 g	36,80	4	480-14
570 g	30,29	4	480-20

Martelo de carpinteiro de garra com espigão



485W

	€		
650 g	28,74	6	485W-650
750 g	30,48	6	485W-750
	9,27	1	SH-485W
	7,37	1	SH-485W-PLATES

Martelo de pena



490

	€		
100 g	22,22	4	490-3.5

Martelo modelador



492

	€		
100 g	28,49	6	492-3.5

Martelo de marceneiro



483

	€		
100 g	9,93	6	483-16
160 g	11,05	6	483-20
200 g	11,96	6	483-22
300 g	13,48	6	483-25
400 g	14,98	6	483-28

Marreta



484

	€		
1000 g	30,48	6	484-1000
1250 g	34,48	6	484-1250
1500 g	39,01	6	484-1500
2000 g	42,98	4	484-2000

MARTELOS DE CONSTRUÇÃO

Martelo de carpinteiro. Suporte magnetizado para pregos



485

	€		
600 g	31,37	6	485

Suporte magnetizado para pregos

Martelo de marceneiro com pega de fibra de vidro



483F

	€		
100 g	11,42	6	483F-16
160 g	12,71	6	483F-20
200 g	13,76	6	483F-22
300 g	15,50	6	483F-25
400 g	17,22	6	483F-28
500 g	18,81	4	483F-30

Marreta com pega de fibra de vidro



484F

	€		
1000 g	35,05	6	484F-1000
1250 g	39,65	6	484F-1250
1500 g	44,86	6	484F-1500
2000 g	49,42	4	484F-2000

Maceta



407

	€		
700 g	15,41	5	407-700
1000 g	17,11	6	407-1000
1400 g	19,13	6	407-1400

Cabo de marreta em fibra de vidro



407F

	€		
700 g	17,91	6	407F-700
1000 g	19,76	6	407F-1000
1400 g	22,56	6	407F-1400

MARRETA DE CABEÇA QUADRADA.
CABO DE MADEIRA



488

	€		
2000 g	35,22	2	488-2000
3000 g	42,58	2	488-3000
4000 g	49,35	2	488-4000
5000 g	59,03	2	488-5000
6000 g	64,87	1	488-6000

MARRETA DE CABEÇA QUADRADA.
CABO DE FIBRA DE VIDRO



488F

	€		
2000 g	39,67	2	488F-2000
3000 g	46,29	2	488F-3000
4000 g	52,40	2	488F-4000
5000 g	62,21	4	488F-5000
6000 g	67,52	2	488F-6000

Martelo de pedreiro



486W

	€		
500 g	23,05	4	486W-500
600 g	23,75	4	486W-600
	8,68	1	SH-486W

Martelo de pedreiro tipo espanhol



486-700

	€		
700 g	22,92	6	486-700

Martelo de pedreiro tipo espanhol



486F

	€		
700 g	29,37	6	486F-700

Martelo de pedreiro



486

	€		
600 g	30,26	4	486

Prego de pedreiro



4401

	€		
255 mm	6,03	10	440102500
300 mm	6,34	10	440103000



Cabos de madeira suplentes



WSH

	€		
407	4,50	1	SH-407
491-3000 & 491-4000	18,27	12	SH-491-34
491-5000 & 491-6000	29,06	12	SH-491-56
488-2000	13,01	10	SH-488-2000
488-3000, 488-4000	18,84	10	SH-488-34
488-5000, 488-6000	20,57	10	SH-488-56
427-700	5,97	10	SH-427-700
486-700, 495-500, 495-600, 493-500, 493-600	5,97	10	SH-486-493-495

Pá-machado tipo espanhol



493F

	€		
500 g	27,44	6	493F-500
600 g	29,85	1	493F-600

Machado



494

	€		
600 g	31,21	4	494-600

Cabos de fibra de vidro suplentes



FSH

	€		
488f-2000	16,05	10	SH-488F-2000
488F-3000 & 488F-4000	19,90	1	SH-488F-34
488F-5000 & 488F-6000	21,23	1	SH-488F-56
428-700	8,62	10	SH-428-700
486F-700, 495F-500, 495F-600, 493F-500, 493F-600	8,62	10	SH-486F493F495F

Pá-picareta tipo espanhol



495

	€		
500 g	23,35	6	495-500
600 g	24,34	6	495-600

MAÇOS

Martelo anti-ricochete. em poliuretano



3625AR

g	€		
550 g	34,29	34	3625AR-35
1430 g	56,64	18	3625AR-50
1550 g	73,69	12	3625AR-60

em poliuretano

MARTELOS ESPECIAIS

Pá-machado tipo espanhol



493

	€		
500 g	22,88	6	493-500
600 g	24,54	6	493-600

Pá-picareta tipo espanhol



495F

	€		
500 g	26,72	6	495F-500
600 g	29,37	1	495F-600

Pontas sobresselentes para martelos 3625AR



3625ARL

		€		
35 mm	3625AR-35	1,40	6	3625ARL-35
50 mm	3625AR-50	5,54	6	3625ARL-50
60 mm	3625AR-60	9,27	6	3625ARL-60

Pega sobresselente para martelos
3625AR



3625ARLH

	L	€		
3625AR-35	290 mm	4,60	80	3625ARLH-35
3625AR-60	300 mm	4,86	50	3625ARLH-50
3625AR-60	390 mm	5,12	16	3625ARLH-60

MARRETA. MARRETA DE CABEÇA
QUADRADA



491

	€		
3000 g	36,89	4	491-3000
4000 g	41,08	4	491-4000
5000 g	48,55	4	491-5000
6000 g	53,67	4	491-6000

MARTELOS DE FACE MACIA

Termoplastik Poliüretan Çekiçler



3625Y

g	€		
120 g	42,22	6	3625Y-22
225 g	60,56	6	3625Y-32
372 g	83,69	6	3625Y-40
484 g	117,95	6	3625Y-50

LY: carrinhos suplentes

CABEÇA DE SUBSTITUIÇÃO, PAR,
PARA 3625Y



3625YL

		€		
3625Y-22	22 mm	17,04	20	3625YL-22
3625Y-32	32 mm	29,59	20	3625YL-32
3625Y-40	40 mm	52,67	20	3625YL-40
3625Y-50	50 mm	87,32	20	3625YL-50

Maço



3625PU

	€		
300 g	30,65	12	3625PU-30
790 g	50,59	6	3625PU-50
1080 g	76,31	6	3625PU-60

Marreta Segurança



489-1100/489-1800

	€		
1100 g	111,08	8	489-1100
1800 g	111,43	8	489-1800

Martelo anti-ricochete



3625PU-105

	g	€		
5000 g	5600 g	250,37	4	3625PU-105

Marreta de segurança



489-2700/489-5400

	€		
2700 g	209,03	4	489-2700
3600 g	249,00	4	489-3600
4500 g	269,65	4	489-4500
5400 g	299,95	4	489-5400

Ahşap Saplı Selüloz Asetat Çekiç



3625N

g	€		
120 g	44,91	6	3625N-22
225 g	48,51	6	3625N-32
372 g	81,63	6	3625N-40
484 g	98,91	6	3625N-50

NL: polls suplentes



CABEÇA DE SUBSTITUIÇÃO, PAR, PARA 3625N



3625NL

	Ø	€		
3625N-22	22 mm	12,59	20	3625NL-22
3625N-32	32 mm	21,46	20	3625NL-32
3625N-40	40 mm	37,29	20	3625NL-40
3625N-50	50 mm	62,26	20	3625NL-50

Martelo de nylon. WL = pontas suplentes, WLH = cabo suplente



3625W

g	€		
150 g	11,01	120	3625W-22
250 g	15,74	1	3625W-28
490 g	19,83	1	3625W-35
1050 g	28,94	1	3625W-44
1470 g	55,66	12	3625W-55

WL pontas suplentes, WLH cabo suplente

CABEÇA DE SUBSTITUIÇÃO, PAR, PARA 3625W E PARA 3625S



3625WL

	Ø	€		
3625W-22	22 mm	4,19	10	3625WL-22
3625W-28, 3625S-28	28 mm	4,65	10	3625WL-28
3625W-35, 3625S-35	35 mm	5,66	10	3625WL-35
3625W-44, 3625S-44	44 mm	6,19	10	3625WL-44
3625W-55	55 mm	8,19	6	3625WL-55

Pega sobresselente para martelos 3625W



3625WLH

	€		
3625W-22	3,39	50	3625WLH-22
3625W-28	3,57	50	3625WLH-28
3625W-35	3,83	80	3625WLH-35
3625W-44	4,48	50	3625WLH-44
3625W-55	4,74	16	3625WLH-55

Martelo com ponta em nylon - eixo metálico



3625S

g	€		
350 g	23,50	50	3625S-28
610 g	31,34	30	3625S-35
1100 g	44,37	18	3625S-44

Maço em borracha



3625RM

g	€		
290 g	10,91	50	3625RM-55
460 g	11,78	40	3625RM-65
660 g	14,12	30	3625RM-75
850 g	17,15	20	3625RM-90

Marreta de cobre



4130

	€		
500 g	63,78	12	413005000
1000 g	105,08	12	413010000
1500 g	138,00	12	413015000
2000 g	180,83	6	413020000
3000 g	183,55	1	413030000
4000 g	243,68	1	413040000



Ferramentas para limpeza de florestas e silvicultura



MACHADOS E MARTELOS FLORESTAIS

Machado universal



HUS

mm	g	€	Icon	Icon	Model
380 mm	770 g	33,53	4		HUS-0.6-380
500 mm	1080 g	37,50	4		HUS-0.8-500

Machado tipo Alemão



HGPS

mm	g	€	Icon	Icon	Model
380 mm	944 g	32,95	4		HGPS-0.8-380-WB
400 mm	1130 g	34,75	4		HGPS-1.0-400-WB
360 mm	790 g	23,27	10		HGPS-0.6-360
380 mm	1020 g	28,45	4		HGPS-0.8-380
400 mm	1260 g	31,83	4		HGPS-1.0-400

Machado universal



HUS-1.0-650

mm	g	€	Icon	Icon	Model
650 mm	1380 g	42,20	4		HUS-1.0-650

Machado Multi-Usos Tipo Canadiano



HFGPS

mm	g	€	Icon	Icon	Model
380 mm	1010 g	45,49	4		HFGPS-0,7-400FG

Machado biscoinho



FGS-810

mm	g	€	Icon	Icon	Model
800 mm	2260 g	55,09	4		FGS-1.6-810
800 mm	2460 g	59,94	4		FGS-1.8-810

Machado tipo Canadiano



FCP

mm	g	€	Icon	Icon	Model
800 mm	2500 g	81,88	4		FCP-1.8-810
850 mm	3000 g	91,09	2		FCP-2.3-860

Machado tipo Alemão



FGS

mm	g	€	Icon	Icon	Model
700 mm	1730 g	51,68	4		FGS-1.25-700-WB
810 mm	2210 g	57,90	4		FGS-1.6-810-WB
600 mm	1400 g	46,39	4		FGS-1.0-600
700 mm	1850 g	48,89	4		FGS-1.25-700

Machado tipo francês



FFSS

mm	g	€	Icon	Icon	Model
900 mm	2400 g	67,99	4		FFSS-1.5-900FG

Machado de rachar



SUS

mm	g	€	Icon	Icon	Model
800 mm	2600 g	83,51	4		SUS-2.0-800

Machado tipo Canadiano



MCP

mm	g	€	Icon	Icon	Model
800 mm	3280 g	73,40	2		MCP-2.5-810

Maço de madeira



LS-MASSE

mm	g	€	Icon	Icon	Model
900 mm	4800 g	57,46	2		LS-MASSE-4FG
900 mm	4640 g	46,54	2		LS-MASSE-4

Maceta



LS-MASSE-TR

		€		
900 mm	4840 g	63,18	2	LS-MASSE-TR-4FG

Cabos de machado suplentes



SH

	€		
800 mm	27,06	1	SH-FCS-810
900 mm	31,07	1	SH-FCS-860
600 mm	21,44	1	SH-FGS-600
700 mm	23,40	12	SH-FGS-700
800 mm	27,87	1	SH-FGS-800
900 mm	20,22	1	SH-FGS-1.8-810
375 mm	19,33	1	SH-HFGPS-400FG
400 mm	17,15	1	SH-HGPS-400
900 mm	20,89	12	SH-MES-F-900
360 mm	14,49	12	SH-HGPS-360
380 mm	15,54	1	SH-HGPS-380
380 mm	15,54	1	SH-HUS-380
500 mm	20,39	1	SH-HUS-500
650 mm	23,05	1	SH-HUS-650
900 mm	26,82	12	SH-MES-900
915 mm	40,15	12	SH-MES-900FG
800 mm	27,87	12	SH-SUS-800
800 mm	27,87	1	SH-MCS-800
905 mm	33,63	1	SH-FCP-860

Machado tipo Europeu



LS/MES

		€		
900 mm	3390 g	49,31	2	LS-MERLIN-2.5
900 mm	3330 g	63,65	2	LS-MERLIN-2.5FG
900 mm	3580 g	53,78	2	MES-3.0-900

Machado Universal



MES

		€		
900 mm	4250 g	59,98	2	MES-3.5-900
900 mm	4310 g	77,08	2	MES-3.5-900FG

Picareta



PAGES-2.0-900FG

		€		
900 mm	3000 g	74,97	1	PAGES-2.0-900FG

Cabeça de substituição para picareta



PAGES

		€		
450 mm	2000 g	31,19	1	PAGES-2.0

Cabo de substituição para picareta



SH-PAGES

		€		
900 mm	690 g	20,57	1	SH-PAGES-900
920 mm	1030 g	47,59	1	SH-PAGES-900FG

CUNHAS

Calços biscainhos



LS-COIN

		€		
260 mm	295 g	31,49	2	LS-COIN 26 CM
190 mm	170 g	29,31	4	LS-COIN 19 CM

Calços de rachar



WT

		€		
220 mm	2000 g	57,94	4	W-T-2.0

Cunhas em aço



WS

		€		
220 mm	1500 g	20,13	4	W-S-1.5
250 mm	2000 g	25,65	4	W-S-2.0
260 mm	2500 g	31,83	4	W-S-2.5





BAHCO



Formões e punções



FORMÕES

Formão com haste octogonal e revestimento de plástico



3656

L	W	€	PK	PK
129 mm	12 mm	9,59	50	3656-125
155 mm	16 mm	13,54	50	3656-150
178 mm	19.5 mm	9,59	1	3656-175

Formões



3640

L	W	€	PK	PK
150 mm	18 mm	16,44	25	3640-150-C
200 mm	22 mm	18,94	25	3640-200-C
250 mm	28 mm	22,48	20	3640-250-C
300 mm	26 mm	28,80	25	3640-300-C

Formão



3745

L	Ø	€	PK	PK
150 mm	6 mm	13,64	50	3745-150
175 mm	7 mm	17,43	25	3745-175
200 mm	8 mm	18,49	20	3745-200
250 mm	9 mm	26,05	10	3745-250

Talhadeira chata



3740

L	€	PK	PK
100 mm	9,17	50	3740-100
125 mm	11,05	50	3740-125
150 mm	12,63	50	3740-150
175 mm	13,37	25	3740-175
200 mm	14,50	25	3740-200
250 mm	15,26	10	3740-250
300 mm	16,32	10	3740-300

Cinzel de pedreiro com haste octogonal e acabamento de cobre envernizado



3756

L	W	€	PK	PK
125 mm	10 mm	6,85	50	3756-125
150 mm	12 mm	8,50	50	3756-150

Formão com haste octogonal e acabamento de cobre envernizado



3749

L	Ø	€	PK	PK
125 mm	10 mm	6,85	50	3749-125

Escopro chato



SB-3740

L	€	PK	PK
125 mm	11,52	87	SB-3740-125
150 mm	13,11	25	SB-3740-150
175 mm	14,67	25	SB-3740-175
200 mm	15,27	25	SB-3740-200
250 mm	16,11	25	SB-3740-250
300 mm	16,91	25	SB-3740-300

Formão com haste octogonal plana e revestimento de plástico



3649

L	Ø	€	PK	PK
128 mm	12 mm	9,59	50	3649-125

Talhadeira de rachar



3750

L	W	€	PK	PK
240 mm	26 mm	18,07	25	3750

Talhadeira de pedreiro



3736M

L	€		
200 mm	15,78	30	3736M-200
250 mm	20,74	25	3736M-250
300 mm	27,49	10	3736M-300
400 mm	36,25	10	3736M-400

Formão



8740

L	€		
200 mm	9,96	5	874002000
250 mm	10,91	5	874002500
300 mm	12,31	5	874003000
350 mm	13,64	5	874003500
400 mm	17,15	5	874004000
500 mm	20,45	5	874005000

Conjunto de talhadeiras, 6 pcs



3736S/6

g	€		
840 g	60,37	5	3736S/6

3735-4-120, 3735-5-150

3733-3

3749-125

3756-125, 3756-150

Formão afiado



3739-250 / -400

L	Ø	€		
250 mm	16 mm	20,84	25	3739-250
300 mm	18 mm	27,60	10	3739-300
400 mm	18 mm	36,45	10	3739-400

FORMÕES COM RESGUARDO

Escopro com protecção



3750H

L	€		
240 mm	26,32	25	3750H

Escopro com protecção



3736MH

L	€		
250 mm	28,58	10	3736MH-250
300 mm	35,13	10	3736MH-300
400 mm	43,96	5	3736MH-400

Ponteiro com protecção



3739H

L	Ø	€		
250 mm	16 mm	28,74	15	3739H-250
300 mm	18 mm	35,32	10	3739H-300
400 mm	18 mm	44,18	10	3739H-400

FORMÕES, RETIFICÁVEIS

Formões



8741

L	€		
200 mm	15,96	6	874102000
250 mm	16,80	5	874102500
300 mm	17,95	5	874103000
350 mm	19,20	4	874103500
400 mm	21,97	5	874104000

Ponteiro octogonal



8746

L	Ø	€		
200 mm	14 mm	8,34	5	874602000
250 mm	14 mm	9,26	5	874602500
300 mm	16 mm	10,41	5	874603000
350 mm	16 mm	11,84	5	874603500
400 mm	18 mm	14,17	5	874604000



Cinzel de electricista



8760

↔ L	€	📦	🐟
200 mm	8,98	10	876002000
250 mm	9,37	5	876002500

Cinzel de pedreiro



8770

↔ L	€	📦	🐟
240 mm	16,37	25	877002400

ACESSÓRIOS PARA CINZELS FRIOS

Cabos para cinzéis



8749

∅	€	📦	🐟
16x16 mm	5,31	1	874916X16
18x18 mm	5,31	1	874918X18
23x13 mm	5,31	1	874923X13
26x7 mm	5,31	1	874926X7

PUNÇÕES

Punções com proteção de mãos



3643

∅	↔ L	€	📦	🐟
3 mm	100 mm	17,89	50	3643-100
4 mm	120 mm	20,14	50	3643-120
5 mm	120 mm	25,75	50	3643-150

Punções



3735

∅	↔ L	€	📦	🐟
4 mm	120 mm	5,32	50	3735-4-120
5 mm	120 mm	6,56	50	3735-5-120
5 mm	150 mm	8,73	50	3735-5-150

Punção longo em blister



3735N

∅	↔ L	€	📦	🐟
2 mm	100 mm	5,54	10	3735N-2-100
4 mm	120 mm	6,16	10	3735N-4-120
5 mm	120 mm	6,96	10	3735N-5-120
6 mm	150 mm	7,57	10	3735N-6-150
8 mm	150 mm	7,57	10	3735N-8-150
2 mm	100 mm	6,33	1	SB-3735N-2-100
4 mm	120 mm	6,93	60	SB-3735N-4-120
5 mm	120 mm	7,74	1	SB-3735N-5-120
6 mm	150 mm	8,36	1	SB-3735N-6-150
8 mm	150 mm	8,36	1	SB-3735N-8-150

SB: Embalagem em blister

Conjunto punções longo. 2-4-6-8mm



3735NS/4

g	€	📦	🐟
340 g	27,62	25	3735NS/4

2-4-6-8mm

3735N-6-150, 3735N-8-150, 3735N-2-100, 3735N-4-120

Punção (riscador)



1157

∅	↔ L	€	📦	🐟
2 mm	130 mm	13,82	60	1157

Punções com proteção de mãos



3644

∅	↔ L	€	📦	🐟
2 mm	120 mm	15,00	50	3644-120
3 mm	125 mm	17,70	50	3644-125
4 mm	130 mm	21,40	50	3644-130
4 mm	150 mm	23,01	50	3644-150
5 mm	165 mm	23,72	50	3644-165
6 mm	180 mm	31,70	50	3644-180
8 mm	200 mm	35,93	50	3644-200

Punção de precisão



3659

Ø	L	€	Box	Fish
0.9 mm	70 mm	12,13	5	3659-0.9
1.4 mm	81 mm	12,35	5	3659-1.4
1.8 mm	84 mm	12,70	5	3659-1.8
2.4 mm	92 mm	13,65	5	3659-2.4
2.8 mm	95 mm	14,39	5	3659-2.8
3.4 mm	97 mm	14,69	5	3659-3.4
3.9 mm	100 mm	13,54	5	3659-3.9
5.9 mm	100 mm	14,96	5	3659-6.0

Punção com protecção



3658A

Ø	L	€	Box	Fish
2 mm	150 mm	18,17	125	3658A-2
3 mm	150 mm	18,36	125	3658A-3
4 mm	150 mm	18,36	125	3658A-4
5 mm	150 mm	18,43	125	3658A-5
6 mm	150 mm	18,43	125	3658A-6
8 mm	150 mm	18,43	50	3658A-8

Ø	L	€	Box	Fish
8 mm	150 mm	7,57	10	3734N-8-150
9 mm	150 mm	7,57	10	3734N-9-150
10 mm	150 mm	7,57	10	3734N-10-150
2 mm	150 mm	6,92	1	SB-3734N-2-150
3 mm	150 mm	6,92	1	SB-3734N-3-150
4 mm	150 mm	7,12	60	SB-3734N-4-150
5 mm	150 mm	7,12	1	SB-3734N-5-150
6 mm	150 mm	8,36	60	SB-3734N-6-150
7 mm	150 mm	8,36	1	SB-3734N-7-150
8 mm	150 mm	8,36	1	SB-3734N-8-150
10 mm	150 mm	8,36	1	SB-3734N-10-150

Punções



3733

Ø	L	€	Box	Fish
2 mm	120 mm	5,05	50	3733-2
3 mm	120 mm	5,05	50	3733-3
4 mm	120 mm	4,95	50	3733-4
5 mm	120 mm	4,95	50	3733-5
6 mm	120 mm	4,95	50	3733-6

Punção de arrombar



3734

Ø	L	€	Box	Fish
2 mm	150 mm	8,54	50	3734-2
3 mm	150 mm	8,54	50	3734-3
4 mm	150 mm	8,54	50	3734-4
5 mm	150 mm	8,54	50	3734-5
6 mm	150 mm	8,54	50	3734-6
8 mm	150 mm	8,73	50	3734-8

Conjunto de punções



3646/6

g	€	Box	Fish
730 g	142,82	25	3646/6

3646-115, 3646-125, 3646-150, 3646-165, 3646-180, 3646-200

Punção com protecção



3646

Ø	L	€	Box	Fish
2 mm	115 mm	17,89	250	3646-115
3 mm	125 mm	17,89	250	3646-125
4 mm	150 mm	17,97	125	3646-150
5 mm	165 mm	18,14	125	3646-165
6 mm	180 mm	20,75	50	3646-180
8 mm	200 mm	24,92	50	3646-200

Punção de arrombar em blister



3734N

Ø	L	€	Box	Fish
2 mm	150 mm	6,14	10	3734N-2-150
3 mm	150 mm	6,14	10	3734N-3-150
4 mm	150 mm	6,34	10	3734N-4-150
5 mm	150 mm	6,34	10	3734N-5-150
6 mm	150 mm	7,57	10	3734N-6-150
7 mm	150 mm	7,57	10	3734N-7-150

Conjunto misto



3654R

g	€	Box	Fish
870 g	158,47	1	3654R

2 x 3656, 1 x 3649, 2 x 3644, 1 x 3643



Conjunto de punções



3659/8

g	€		
270 g	113,78	1	3659/8

3659-0.9, 3659-1.4, 3659-1.8, 3659-2.4, 3659-2.8, 3659-3.4, 3659-3.9, 3659-6.0

Conjunto de punções



3658A/6

g	€		
560 g	135,80	30	3658A/6

3658A-2, 3658A-3, 3658A-4, 3658A-5, 3658A-6, 3658A-8

Conjunto de punções de arrombar. 9peças 2-10mm



3734NS/9

g	€		
750 g	62,16	10	3734NS/9

9peças 2-10mm

3734N-10-150, 3734N-9-150, 3734N-8-150, 3734N-7-150, 3734N-6-150, 3734N-5-150, 3734N-4-150, 3734N-3-150, 3734N-2-150

Conjunto de punções



3734S/6

g	€		
720 g	67,22	5	3734S/6

3734-2, 3734-3, 3734-4, 3734-5, 3734-6, 3734-8

Conjunto de punções



3659/8T

g	€		
170 g	108,85	1	3659/8T

3659-0.9, 3659-2.8, 3659-2.4, 3659-1.8, 3659-6.0, 3659-3.9, 3659-3.4, 3659-1.4

Arranca-pregos



3732

		€		
2 mm	125 mm	5,94	60	SB-3732-2-125
2.5 mm	125 mm	5,94	60	SB-3732-2.5-125
3.2 mm	125 mm	5,94	60	SB-3732-3.2-125
4 mm	125 mm	5,94	1	SB-3732-4-125

Conjunto misto



3656/10

g	€		
1260 g	262,02	1	3656/10

3 x 3656, 1 x 3644, 1 x 3649, 1 x 3643 en 3 x 3646

Conjunto de punções cónicas: 5peças



3733S/5

g	€		
410 g	26,81	25	3733S/5



3733-4, 3733-2, 3733-6
3733-8, 3733-10

Abre Furos



B400

	€		
2 mm	11,33	1	B400.002
3 mm	11,33	1	B400.003
4 mm	11,33	1	B400.004
5 mm	11,33	1	B400.005
6 mm	11,33	1	B400.006
7 mm	11,33	1	B400.007

Ø	€		
8 mm	11,33	1	B400.008
9 mm	11,33	1	B400.009
10 mm	11,33	1	B400.010
11 mm	14,26	1	B400.011
12 mm	14,26	1	B400.012
13 mm	14,26	1	B400.013
14 mm	14,26	1	B400.014
15 mm	14,26	1	B400.015
16 mm	14,26	1	B400.016
17 mm	14,26	1	B400.017
18 mm	14,26	1	B400.018
19 mm	14,26	1	B400.019
20 mm	14,26	1	B400.020
21 mm	18,90	1	B400.021
22 mm	18,90	1	B400.022
23 mm	18,90	1	B400.023
24 mm	18,90	1	B400.024
25 mm	18,90	1	B400.025
26 mm	18,90	1	B400.026
27 mm	18,90	1	B400.027
28 mm	18,90	1	B400.028
29 mm	18,90	1	B400.029
30 mm	18,90	1	B400.030
31 mm	24,41	1	B400.031
32 mm	24,41	1	B400.032
33 mm	24,41	1	B400.033
34 mm	24,41	1	B400.034
35 mm	24,41	1	B400.035
36 mm	24,41	1	B400.036
37 mm	24,41	1	B400.037
38 mm	24,41	1	B400.038
39 mm	24,41	1	B400.039
40 mm	24,41	1	B400.040
41 mm	28,71	1	B400.041
42 mm	28,71	1	B400.042
43 mm	28,71	1	B400.043
44 mm	28,71	1	B400.044
45 mm	28,71	1	B400.045
46 mm	28,71	1	B400.046
47 mm	28,71	1	B400.047
48 mm	28,71	1	B400.048
49 mm	28,71	1	B400.049
50 mm	28,71	1	B400.050

Abre furos com cabo de 2 a 30 mm



WPH3-30

L	g	€		
185 mm	500 g	44,71	1	WPH 3-30

Abre furos com cabo de 2 a 50 mm



WPH2-50

L	g	€		
180 mm	761 g	136,99	1	WPH 2-50

Jogo abre furos, 11 peças



400.003.020

Ø	€		
3-20 mm	87,06	1	400.003.020

Abre furos com cabo de 2 a 20 mm



WPH3-20

L	g	€		
95 mm	290 g	33,29	1	WPH 3-20

Jogo Abre Furos 16 peças



400.003.030

Ø	€		
3-30 mm	214,41	1	400.003.030

Conjunto de abre furos de 2 a 50 mm



400.002.050

Ø	€		
2-50 mm	494,20	1	400.002.050

Alicate de furar



2635

L	€		
245 mm	60,64	1	2635



Jogo abre furos rotativo



4630

	€		
220 mm	23,60	1	4630

Punções de parafuso



6900

	€		
16 mm	60,64	1	690000160
20 mm	76,02	1	690000200
22 mm	76,02	1	690000220
25 mm	86,33	1	690000250
30 mm	93,45	1	690000300
32 mm	93,45	1	690000320
35 mm	119,67	1	690000350
40 mm	128,29	1	690000400
50 mm	157,43	1	690000500
63 mm	364,89	1	690000630

Conjunto de 7 peças de punções de parafuso



6907

	€		
4080 g	986,68	1	69079019P

690000160, 690000250, 690000200, 690000320,
690000500, 690000400, 690000630

690900120, 690900080, 690900100, 690900200,
690900140

Parafusos sobresselentes para punções de parafuso



6909

	€		
16 mm	12,66	4	690900080
20-25 mm	18,69	4	690900100
30-35 mm	18,69	2	690900120
40-50 mm	27,88	2	690900140
63 mm	55,09	1	690900200

PUNÇÕES COM PUNHO DE 2 PEÇAS

Punção de centro com pega de dois componentes e proteção



SB3755BM

		€		
4 mm	165 mm	10,29	1	SB3755BM-4
6 mm	185 mm	11,45	5	SB3755BM-6

SB = Em embalagem individual

Punção de pino paralelo cilíndrico com pega de dois componentes



SB3734BM

		€		
10 mm	180 mm	14,52	5	SB3734BM-10
3 mm	155 mm	12,68	5	SB3734BM-3
4 mm	165 mm	13,03	5	SB3734BM-4
5 mm	165 mm	13,43	5	SB3734BM-5
6 mm	185 mm	13,84	5	SB3734BM-6
8 mm	185 mm	14,10	5	SB3734BM-8

SB = Em embalagem individual

Conjunto de punções paralelos Bi material



3734BMS/7

	€		
900 g	97,41	1	3734BMS/7

3734BM-2, 3734BM-3, 3734BM-4, 3734BM-5, 3734BM-6, 3734BM-8, 3734BM-10

FORMÕES COM PUNHOS DE 2 PEÇAS

Cinzel Mason com punho de 2 componentes



SB3654BM

	€		
155 mm	13,96	5	SB3654BM-15
185 mm	14,83	5	SB3654BM-20

SB = Em embalagem individual

Conjunto de cinzeis para pedreiro mistos



3654BMS/7

	€		
920 g	99,95	1	3654BMS/7

3734BM-2, 3734BM-4, 3734BM-5, 3734BM-6, 3654BM-15, 3654BM-20, 3755BM-6



Pés de cabra



BARRAS DE DEMOLIÇÃO

Alavancas ajustáveis



APB260

L	g	€	Icon 1	Icon 2	Code
260 mm	410 g	62,12	10		APB260

Alavancas ajustáveis



APB360

L	g	€	Icon 1	Icon 2	Code
360 mm	543 g	62,77	10		APB360

ALAVANCA PÉ DE GALO -
EXTREMIDADE DE PRECISÃO DE 10"



CFP250

L	€	Icon 1	Icon 2	Code
250 mm	23,78	6		CFP250

Pé-de-cabra premium



WBP

Ø	L	€	Icon 1	Icon 2	Code
14 mm	346 mm	37,53	20		WBP300
16 mm	487 mm	41,41	12		WBP500
17 mm	625 mm	54,36	12		WBP625
17 mm	704 mm	60,82	10		WBP710
20 mm	890 mm	89,30	6		WBP900

Pé-de-cabra básico



WBB

L	Ø	€	Icon 1	Icon 2	Code
391 mm	14 mm	19,41	10		WBB400
500 mm	16 mm	20,71	10		WBB500
595 mm	18 mm	22,00	10		WBB600
680 mm	18 mm	23,94	6		WBB700
810 mm	18 mm	27,18	6		WBB800
1000 mm	20 mm	41,55	4		WBB1000
1200 mm	20 mm	48,08	4		WBB1200
1500 mm	22 mm	64,08	4		WBB1500

Pé-de-cabra plano



WBF380

L	Ø	€	Icon 1	Icon 2	Code
374 mm	35 mm	20,71	12		WBF380

Mini pé-de-cabra plano



WBMF190

Ø	L	€	Icon 1	Icon 2	Code
18 mm	188 mm	10,29	24		WBMF190

Minibarras de demolição planas com
extremidade dobrada e plana - 15 peças/
visor



WBMF190IP

g	€	Icon 1	Icon 2	Code
39 g	10,62	15		WBMF190IP

WBMF190x 15

Conjunto de pés de cabra - plano, mini e
premium com extremidade de 346 mm



WBP-3P-3FMF

g	€	Icon 1	Icon 2	Code
1600 g	67,17	1		WBP-3P-3FMF

WBP300

WBF380

WBMF190

Conjunto de pés de cabra - plano, mini e premium com extremidade de 621 mm



WBP-3P-6FMF

	€		
3000 g	77,00	1	WBP-3P-6FMF

WBP625	
WBF380	
WBMF190	

Conjunto de pés de cabra premium



WBP-3P-963

	€		
4740 g	164,68	1	WBP-3P-963

WBP900, WBP625, WBP300	
------------------------	--

Conjunto de pés de cabra premium e planos



WBP-3P-96F

	€		
6000 g	148,09	1	WBP-3P-96F

WBP900, WBP625	
WBF380	





BAHCO



Ferramentas para plantar e podar



FERRAMENTAS DE JARDIM PEQUENAS

Enxada Pequena



P262

	€		
315 mm	16,32	10	P262

Enxada de Bordo uma ponta



P278

	€		
455 mm	21,16	5	P278

Pá Pequena



P263

	€		
370 mm	18,36	10	P263

Enxada Bordo



P272

	€		
450 mm	20,87	5	P272

Enxada de duas pontas



P267

	€		
320 mm	16,91	10	P267

Cultivador de Bordo



P264

	€		
315 mm	16,45	10	P264

Enxada de uma ponta



P268

	€		
320 mm	16,91	10	P268

Enxada de Bordo duas pontas



P277

	€		
455 mm	21,29	5	P277

Cultivador de Bordo



P274

	€		
470 mm	20,28	5	P274

Anchinho de Bordo



P276



450 mm

€

20,81



5



P276

Forquilha Pequena



P270



305 mm

€

15,77



10



P270

Anchinho Pequeno



P266



335 mm

€

16,25



10



P266

Plantador de bolbos



P241



340 g

€

12,68



5



P241

Enxada Pontas



P269



315 mm

€

13,28



10



P269



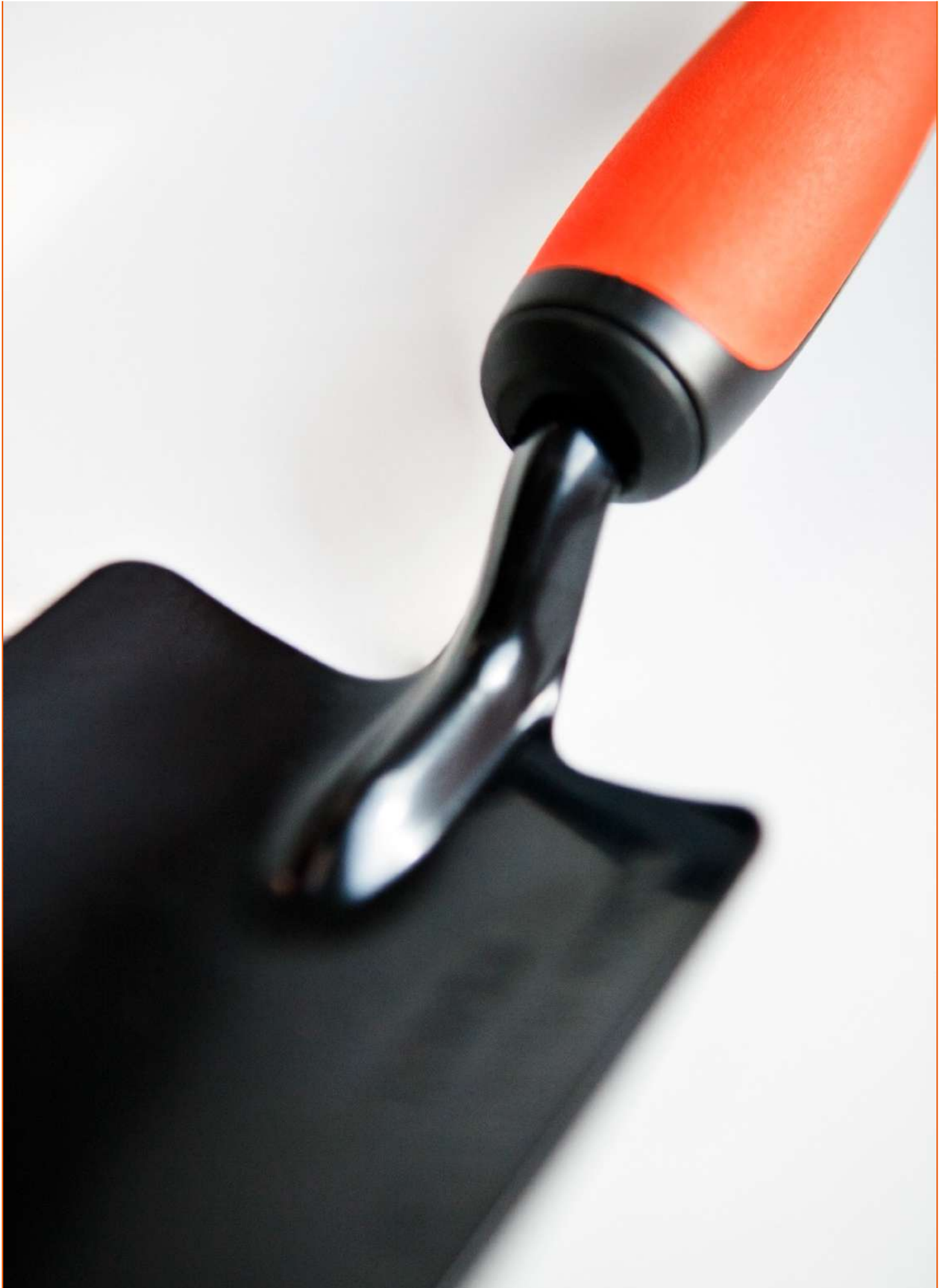

BAHCO



Ferramentas de poda



TESOURAS DE PODAR

Tesouras de poda Ergonomica punho fixo

ergo



PX

	€		
15 mm	56,50	2	PX-S1
20 mm	56,50	2	PX-S2
15 mm	56,50	2	PX-M1
20 mm	56,50	2	PX-M2
20 mm	56,50	2	PX-M2-L
30 mm	56,50	2	PX-M3
20 mm	56,50	2	PX-L2
30 mm	56,50	2	PX-L3

Tesouras de poda Ergonomica punho rotativo

ergo



PXR

	€		
20 mm	81,81	2	PXR-S2-L
15 mm	81,81	2	PXR-S1
20 mm	81,81	2	PXR-S2
15 mm	81,81	2	PXR-M1
20 mm	81,81	2	PXR-M2
20 mm	81,81	2	PXR-M2-L
30 mm	81,81	2	PXR-M3
20 mm	81,81	2	PXR-L2

Acessórios para tesouras de uma mão ergonômicos para PX-PXR



R801P-R804P

	€		
1	38,08	1	R801P
2	38,37	1	R802P
3	38,46	1	R803P
2	33,30	1	R804P

Lâmina de substituição para as tesouras de poda ERGO™ PX e PXR.



R211P/R300P/R500P/R600P

	€		
Px/ Pxr N° 2, P1-20, P2-20	20,06	1	R211P
Px/ Pxr N° 2, P1-20, P2-20	18,67	80	R211P-BULK80
Px/ Pxr N° 1	19,70	1	R300P
Px/ Pxr N° 3	19,78	40	R500P
Px-M2-L & Pxr-M2-L	19,61	1	R600P

Contra lâmina de substituição para as tesouras de poda ERGO™ PX e PXR.



R303P-R603P

	€		
Px-S1, Px-M1, Px-L1, Pxr-M1, Pxr-L1	21,03	1	R303P
Px-S2, Px-M2, Px-L2, Pxr-M2, Pxr-L2	21,25	1	R403P
Px-S3, Px-M3, Px-L3, Pxr-M3, Pxr-L3	19,28	1	R503P
Px-M2-L, Pxr-M2-L	18,77	1	R603P

Par de punhos de substituição para as tesouras de poda ERGO™ PX e PXR com mola. Fornecido com mola.



ergo



R811P-RT825P

	€		
Px-S	26,00	1	R811P
Px-M	24,59	1	R812P
Px-L	24,60	1	R813P
Px-M2-L	25,66	1	R815P
PxR-S	49,92	1	RT821P
PxR-M	47,89	1	RT822P
PxR-L	55,10	6	RT823P
PxR-M2-L	65,33	1	RT824P
PxR-S2-L	49,94	6	RT825P

Fornecido com mola

Perno central de substituição para as tesouras de poda ERGO™ PX e PXR.



R900P

	g	€	
PX & PXR	20 g	8,00	1 R900P

Sistema de bloqueio do perno central para as tesouras de poda ERGO™ PX e PXR.



R901P

	g	€	
PX & PXR	10 g	7,17	30 R901P

Conjunto de quatro parafusos de substituição para os punhos das tesouras de poda ERGO™ PX e PXR.



R902P

Icon	g	€	Icon	Icon
PX & PXR	20 g	6,45	24	R902P

Conjunto de 2 molas de substituição para as tesouras de poda ERGO™ PX e PXR.. R905P: bassa resistenza



R905P-R907P

Icon	g	€	Icon	Icon
PX & PXR, P64	10 g	5,87	1	R905P
PX & PXR, P64	164 g	2,32	50	R905P-BULK50
PX & PXR	10 g	5,87	1	R906P
PX & PXR	220 g	2,46	50	R906P-BULK50
PX & PXR	10 g	6,10	1	R907P

R905P: bassa resistenza

Tesoura de poda



P1

Icon	L	€	Icon	Icon
20 mm	200 mm	42,36	5	P1-20
30 mm	230 mm	47,66	5	P1-23

2 batentes de substituição para as tesouras de poda ERGO™ PX e PXR.. O lote contém 50 tampões



R903P/R1269P

Icon	g	€	Icon	Icon
PX & PXR, P1 & P2, P64	10 g	5,26	1	R903P
PX & PXR, P1 & P2, P64	486 g	1,37	50	R1269P-BULK50

O lote contém 50 tampões

Tesoura Poda



P3

Icon	€	Icon	Icon
20 mm	60,85	2	P3-20-F
25 mm	63,24	2	P3-23-F

Tesoura Poda



P108

Icon	L	€	Icon	Icon
20 mm	200 mm	31,82	2	P108-20-F
25 mm	230 mm	36,37	2	P108-23-F

Fecho de substituição para as tesouras de poda ERGO™ PX e PXR.



R904P

Icon	g	€	Icon	Icon
Px & PXR	10 g	7,36	1	R904P

Tesoura Poda



P110

Icon	€	Icon	Icon
20 mm	30,68	2	P110-20-F
25 mm	34,78	2	P110-23-F

Tesoura Poda



P5

Icon	L	€	Icon	Icon
25 mm	230 mm	71,15	2	P5-23-F



Tesoura de poda tipo bigorna



P138

Blade Size	Length (L)	Price (€)	Quantity	Product Code
20 mm	220 mm	29,87	6	P138-22-BULK6
20 mm	220 mm	42,97	6	P138-22-F

Tesoura Poda



P121

Blade Size	Length (L)	Price (€)	Quantity	Product Code
15 mm	180 mm	23,30	6	P121-18-F
20 mm	200 mm	24,43	6	P121-20-F
25 mm	230 mm	25,57	6	P121-23-F

Bigorna de alumínio com rebite



R221P/R222P

Product Code	Price (€)	Quantity	Product Code
P138-22	7,47	1	R221P
P138-22	5,67	50	R221P-BULK50

Tesoura leveira para colher rosas



P64

Blade Size	Length (L)	Price (€)	Quantity	Product Code
12 mm	210 mm	39,68	12	P64-20-BULK12

Tesoura Poda



P126

Blade Size	Length (L)	Price (€)	Quantity	Product Code
15 mm	190 mm	17,50	6	P126-19-F
20 mm	220 mm	22,50	6	P126-22-F

Lâminas de substituição para P1 e P2.



R201P/R171P

Product Code	Price (€)	Quantity	Product Code
P1-22, P2-22	20,98	1	R201P
P1-22, P2-22	12,45	80	R201P-BULK80

Tesoura de poda para donos de casa, mão direita e esquerda



PG-01-F/PG-03-L

Blade Size	Price (€)	Quantity	Product Code
12-20 mm	31,68	6	PG-01-F
12-20 mm	32,68	2	PG-03-L

Tesoura de poda



PG-12-F

Blade Size	Length (L)	Price (€)	Quantity	Product Code
20 mm	210 mm	15,06	10	PG-12-F
20 mm	210 mm	13,97	15	PG-12-BULK15

Lâminas de substituição com pino para tesouras de poda e tesouras de podar no ar.



R112PG-R124PG/R224P

Product Code	Price (€)	Quantity	Product Code
P3-20, P5-20	16,95	1	R112PG
P108-20, P110-20	17,14	1	R114PG
P3-23, P5-23	18,00	30	R122PG
P108-23, P110-23, P34-27A	18,29	30	R124PG
P138-22	20,41	1	R223P
P138-22	17,00	80	R223P-BULK80

Contra lâminas de substituição para tesouras de poda.



R202P/R271P

€	Icon	Icon
21,55	1	R202P

P1-22, P2-22

Conjunto completo de parafuso e porca central para tesouras de poda.



R239P/R141P/R142P/R157H

€	Icon	Icon
7,71	24	R142P
15,61	1	R148V
8,50	1	R239P

P34-27A, P3-20, P3-23, P5-20, P5-23, P108-20, P108-23, P110-20, P110-23
P121-23
P1-20, P1-22, P2-20, P2-22, P6-20, P7-20

Contra lâmina e pino para tesouras de poda e para tesouras de podar no ar.. Para tesouras de poda de mão e de topo



R113PG/R123PG

€	Icon	Icon
18,29	30	R113PG
18,11	30	R123PG

Para tesouras de poda de mão e de topo

Fecho de substituição para tesouras de poda.



R341P/R474P

€	Icon	Icon
5,05	12	R341P
4,88	1	R474P

P3-20, P3-23
P5-20, P5-23, P108-20, P108-23, P110-20, P110-23

Molas de substituição para tesouras de poda.

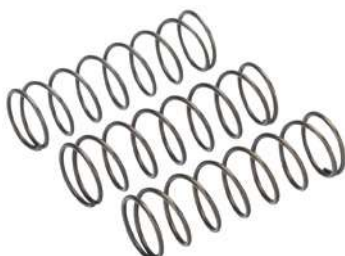

R438P/R463P

€	Icon	Icon
6,67	1	R434P
1,93	50	R434P-BULK50
7,38	1	R463P
6,31	1	R438P
1,94	50	R438P-BULK50

P121-20
P121-20
P121-23
P138-22
P138-22

Mola e batente para tesouras de poda



R1069P

€	Icon	Icon
5,30	12	R1069P

P1-20, P2-20, P6-20, P7-20

Mola, batente de borracha e batente de metal leveiro para tesouras de poda.



R1068

€	Icon	Icon
6,30	1	R1068

P3-20, P3-23, P5-20, P5-23, P108-20, P108-23, P110-20, P110-23

Peças de substituição para a nova P5-20 e P5-23



R1080P

€	Icon	Icon
6,22	1	R1080P

P5-20, P5-23

Conjunto de acessórios, contendo : parafusos, porcas e fecho para tesoura de podar



R1601

€	Icon	Icon
8,30	1	R1601

P1-20, P1-22, P2-20, P6-20, P7-20



Sistema de fecho com parafuso e anilha



R478P/R480P

	€		
P108	9,00	1	R478P
P5	7,28	1	R480P

FERRAMENTAS PARA A APANHA DE FRUTOS

Tesouras para vindima, limpeza e trabalhos florais



P123

	€		
10 mm	11,45	30	P123-19-BULK30

Tesouras para vindima, limpeza e trabalhos florais



P127

	€		
6 mm	11,26	30	P127-19-BULK30

Tesouras para vindima, limpeza e trabalhos florais



P128

	€		
6 mm	14,68	6	P128-19
6 mm	11,56	30	P128-19-BULK30

Tesouras para vindima, limpeza e trabalhos florais



P129

	€		
6 mm	12,55	30	P129-19-BULK30

Molas e amortecedores. P123/P127/P128/P129



R1071/R1075

	g	€	
P123, P127, P128, P129	20 g	10,64	14 R1071
P123, P127, P128, P129	130 g	1,07	50 R1075-BULK50

P123/P127/P128/P129

TESOURÕES

Tesourão poda Super Leve



P114-SL

	L	€	
30 mm	400 mm	76,27	2 P114-SL-40
30 mm	500 mm	77,85	2 P114-SL-50
30 mm	600 mm	84,78	2 P114-SL-60

Tesourão Poda



P16

	L	€	
30 mm	400 mm	76,09	2 P16-40
30 mm	500 mm	91,90	2 P16-50-F
30 mm	600 mm	94,97	2 P16-60-F

Tesourão de poda



P16-40W

	L	€	
30 mm	400 mm	75,91	2 P16-40W

Tesourão Super Leve. Profissional



P116-SL

✂️	↔️ L	€	📦	🐟
35 mm	400 mm	87,96	2	P116-SL-40
35 mm	500 mm	92,11	2	P116-SL-50
35 mm	600 mm	94,98	2	P116-SL-60
35 mm	700 mm	97,90	2	P116-SL-70

Profissional

Tesourão Super Leve Pomar. Profissional



P160-SL

✂️	↔️ L	€	📦	🐟
45 mm	600 mm	102,45	2	P160-SL-60
45 mm	750 mm	108,63	1	P160-SL-75
45 mm	900 mm	116,25	1	P160-SL-90

Profissional

Tesourão de poda



P19

✂️	↔️ L	€	📦	🐟
50 mm	800 mm	167,73	1	P19-80-F

Tesourão Poda com Alavanca. Profissional



P280-SL

✂️	↔️ L	€	📦	🐟
55 mm	600 mm	67,90	2	P280-SL-60
55 mm	800 mm	73,87	2	P280-SL-80

Profissional

Tesourão de poda do tipo bigorna com ação de alavanca



P173-SL

✂️	↔️ L	€	📦	🐟
45 mm	850 mm	106,04	1	P173-SL-85

Tesourão de poda para a poda de árvores e arbustos



P130-P140

✂️	↔️ L	€	📦	🐟
40 mm	450 mm	36,08	6	P130-F
40 mm	660 mm	45,77	6	P140-F

Tesouras Poda de duas mãos



PG-18

✂️	↔️ L	€	📦	🐟
40 mm	450 mm	39,77	2	PG-18-45-F
40 mm	610 mm	43,19	2	PG-18-60-F

Tesoura Poda de duas mãos. com cabos extensíveis



PG-19

✂️	↔️ L	€	📦	🐟
40 mm	700 - 900 mm	58,73	2	PG-19-F

com cabos extensíveis

Lâmina extra para tesourão de poda



R114V/R373A



🔪	€	📦	🐟
P160-SL	19,88	28	R160A-BULK28
P280-SL-80	24,46	25	R185V
P14	32,96	25	R114V
P14	22,84	28	R114V-BULK28
P280	23,17	1	R181P
P-SL2, P116-SL	33,05	1	R16V
P-SL2, P116-SL	22,92	14	R16V-BULK14
P-SL, P114-SL	32,87	8	R115V
P-SL, P114-SL	26,73	14	R115V-BULK14
P16	29,73	1	R116V
P16	25,55	36	R116V-BULK36
P19-80	51,35	1	R119V
P160	25,30	1	R160A
P173-SL-85	32,76	25	R373A



Contra lâmina de substituição para tesourões de poda.



R214V/R26V/R260A/...

	€		
P14	27,93	1	R214V
P14	15,03	28	R214V-BULK28
P116-SL	27,06	8	R216SL
P-SL-40/45/60	28,58	1	R215V
P114-SL	25,80	1	R214SL
P160	24,93	16	R260A
P16*	27,80	40	R716VCB
P180-70	24,21	1	R680V
P19-80	31,72	1	R619V

Batente de borracha de substituição para tesourões de poda e corta sebes.



R430V-R516V

	€		
P-SL, P-SL2, P114, P116, P52-SL, P54-SL	7,65	22	R440V

Batente com parafusos de substituição para tesourões de poda.





R372H

	€		
P172-65 /-85, P172-SL	19,66	1	R372H

Conjunto completo de substituição



R312V-R318V/R143PV/R144PV/R146

	€		
P280-SL	10,62	12	R335V
P16	7,04	1	R143PV
P16*	7,67	1	R143PVCB
P160	7,10	24	R144PV
P14, P174, P176-75	7,12	24	R146VS
P14, P174, P176-75	4,61	50	R146VS-BULK50
P114-SL, P116-SL	9,51	22	R166V
P172-65 /-85	15,02	1	R312V
P-SL-40 /-45 /-60	12,67	1	R315V
P280-(SL)	6,67	22	R328V
P180-70, P19-80, P172	13,58	1	R318V

Conjunto completo (4 pcs) com parafusos e porcas para cabo de tesourões de poda.



R415V-R775V

	€		
P280-SL	10,16	1	R775V
P173-SL-85	18,50	1	R776V
P-SL, P-SL2, P114, P116	9,92	1	R415V
P19-80	10,11	1	R519V
P14, P16	9,38	1	R615V
P160	8,78	24	R660V
P172-SL	6,51	14	R772V
P280-SL-80	6,12	1	R773V

Parafuso hexagonal para ajustar a folha ao batente



R272H

	€		
P173-SL-85	16,71	30	R472H
P172-65/-85, P172-SL-85	9,98	1	R272H

VARAS TELESCÓPICAS E TESOURAS DE PODA NO AR

Varas telescópicas de alumínio





ATP-200

	€		
2000-3520 mm	96,59	1	ATP-200-350
2070-5040 mm	112,51	1	ATP-200-500

Extensão Podar Ar 25 mm



AP-FP-

	€		
2000 - 5000 mm	79,55	1	AP-5M
2000 - 3500 mm	60,23	1	AP-3M
1800 - 3200 mm	98,95	1	FP-3M

Vara telescópica curta e leve em alumínio



ATP-110-210

	€		
1100 - 2100 mm	75,91	1	ATP-110-210

Seção base da vara em alumínio



ASP-1850G

	€		
1870 mm	51,21	1	ASP-1850G



Adaptador para tesoura de podar no ar



ASP-ATP

		€		
160 mm	100 g	27,71	6	ASP-ATP

Tesoura de podar no ar. Sistema de desmultiplicação tripla



P34-37

	€		
40 mm	68,18	2	P34-37



Vara telescópica em alumínio



ASP-1850

	€		
1870 mm	42,17	1	ASP-1850



Adaptador para secção e varas telescópicas



RAUNI

		€		
ATP-110-210	82 g	17,95	6	RAUNI

Tesoura de podar no ar. Sistema de desmultiplicação duplo



P34-27A

	€		
30 mm	36,37	2	P34-27A-F



Adaptador para serrotes com vara telescópica



ASP-AS

	€		
135 mm	18,21	6	ASP-AS

Gancho c/ adaptador p/varas ASP e vara ATP-110-210



ASP-AS-HOOK

	€		
325 g	39,76	4	ASP-AS-HOOK



Tesoura de podar no ar com vara telescópica



ATP-230-410

	€			
32 mm	2370 - 4110 mm	107,96	2	ATP-230-410



Tesouras de podar no ar e extensões



AP-234

		€		
30 mm	2200 mm	92,79	2	AP-234-F

Kit de lâmina sobresselente para ATP-230-410 Podador telescópico

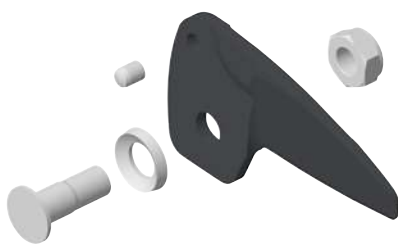

R230P

		€		
ATP-230-410	62 g	23,98	10	R230P

Para-choques de borracha sobresselente e cabo interior para a podador telescópico



RBCP230

		€		
ATP-230-410	66 g	10,58	12	RBCP230

Conjunto de tesoura de podar no ar



ASP3740-P

	€		
40 mm	239,67	1	ASP3740-P3437

ASP-1850G

ASP-1850

P34-37

ASP-ATP

4750-PSTB-1

Mola sobresselente para ATP-230-410 Podador telescópico



R4230

		€		
ATP-230-410	7 g	7,15	10	R4230

Came sobresselente para varas telescópicas ATP



RCAM

		€		
ATP-200-350 ; ATP-200-500 ; ATP-110-210	29 g	4,34	20	RCAM30
ATP-200-500 ; ATP-110-210	37 g	4,34	20	RCAM36

Lâminas de substituição para tesouras de podar no ar P34-37



R137E

	€		
P34-37	20,72	30	R137E

Para-choques de borracha sobresselente para vara telescópica curta



RBCP

		€		
ATP-110-210	30 g	10,95	10	RBCP

Corda de sobresselente para cabeça de corte



RD1M

		€		
ATP-230-410	5 g	13,17	15	RD1M

Parafuso e porca de substituição para tesouras de podar no ar.



R142P/R337E

	€		
P34-37	10,38	1	R337E

Alavanca sobresselente para cabeça de corte para ATP-230-410 Podador telescópico



RPL230G

		€		
ATP-230-410	72 g	25,22	8	RPL230G

Serrote poda, corte médio, para sistema ASP e ATP



ASP-AS-C_M

		€		
360 mm	6.2	64,74	5	ASP-AS-C36-JT-M

Corda sobresselente para cabeça de corte para ATP-230-410 Podador telescópico



RD7M

		€		
ATP-230-410	19 g	24,58	20	RD7M

Mola de substituição para tesouras de podar no ar.



R427AE/R427E/R437E

	€		
P134, P34-27A	9,33	18	R427AE
P34-37	10,38	18	R437E

Serrote poda, corte grosso, para sistema ASP e ATP



ASP-AS-C_C

		€		
390 mm	5.4	71,09	5	ASP-AS-C39-JT-C
450 mm	5.4	73,63	2	ASP-AS-C45-JT-C

Contra lâmina de substituição para tesouras de poda e tesouras de podar no ar.. Para tesouras de poda de mão e de topo



R133PG

	€		
P34-27A	12,83	1	R133PG

Serrote poda, corte fino, para sistema ASP e ATP



ASP-AS-C_F

		€		
330 mm	7	62,08	5	ASP-AS-C33-JT-F

Serrote de poda para extensões



339-/340-

		€		
360 mm	6	17,63	4	339-6T
360 mm	6	18,81	4	340-6T

Para tesouras de poda de mão e de topo



Serrete de poda para extensão de Ø 25 mm



383-/384-

			€		
360 mm	6		19,98	4	383-6T
360 mm	6		18,81	4	384-6T
360 mm	5		18,81	4	384-5T

Serrete de poda para extensão de Ø 25 mm



385-/386-

			€		
360 mm	6		19,98	4	385-6T
360 mm	6		21,15	4	386-6T

Conjunto de serrote com vara telescópica



ASP3740-C36JTM

		€		
1950 mm	2819 g	202,80	1	ASP3740-C36JTM

ASP-1850G				
ASP-1850				
ASP-AS-C36-JT-M				
4750-PSTB-1				

Conj. serrote c/vara telescópica e lâmina de 390 mm



ASP3740-C39JTC

		€		
1950 mm	2838 g	246,36	1	ASP3740-C39JTC

ASP-1850G				
ASP-1850				
ASP-AS-C39-JT-C				
4750-PSTB-1				

Conj. serrote c/vara telescópica e lâmina de 450 mm



ASP3740-C45JTC

		€		
1950 mm	2863 g	247,18	1	ASP3740-C45JTC

ASP-1850G				
ASP-1850				
ASP-AS-C45-JT-C				
4750-PSTB-1				

TESOURAS DE SEBES

Corta sebes-cabos compridos



P51

		€		
570 mm	25 cm	51,71	2	P51-F

Tesouras Corta Sebes Leve. Profissional



P51-SL

		€		
570 mm	25 cm	51,71	2	P51-SL

Professional

Tesoura Corta Sebes Longa. Profissional



P51H-SL

		€		
730 mm	25 cm	54,55	2	P51H-SL

Professional

Corta sebes com cabo de madeira



P57-25

		€		
540 mm	23 cm	39,77	4	P57-25-F

Corta sebes leve, curto



P54-SL

		€			
550 mm	22.5 cm	106,82	2	P54-SL-25	

Corta sebes



PG-56

		€			
540 mm	23 cm	40,91	2	PG-56-F	

Batentes para corta sebes



R440V-R516V

	€			
P14, P16, P180-70, P19-80, P160-60, P51	5,29	22	R515VS	
P160, P160-SL, P280-SL	4,45	22	R516V	
P53-SL, P54H-SL, P52-SL-20	5,94	22	R444V	

Tesoura Corta Sebes Longa. Profissional



P54H-SL

		€			
650 mm	22.5 cm	106,81	2	P54H-SL-25	

Profissional

Corta Sebes Extensíveis



PG-57-F

		€			
800-1050 mm	20 cm	43,19	2	PG-57-F	

Perno central para corta sebes



R146VC/R147V

	€			
P51, P51H, P52, P53, P54, P52-SL-20	8,22	22	R146VC	
P55, P57	7,11	24	R147V	

Tesoura para sebes leve de precisão extra com pega de alumínio



ergo



P52-SL-20

		€			
590 mm	18 cm	88,60	2	P52-SL-20	

Corta sebes universal



P59

		€			
580 mm	21 cm	33,17	6	P59-25-F	

TESOURAS PARA RELVA

Tesoura de relva



GS-76

		€			
355 mm	435 g	20,98	8	GS-76	



Tesoura de relva com vários ângulos



GS-180

		€		
375 mm	317 g	28,62	6	GS-180-F

FACAS PARA PODA

Canivete de enxertia



P11

		€		
180 mm	70 g	40,53	6	P11

Canivete de poda



K-GP-1

	€		
90 g	34,46	10	K-GP-1

Tesoura de relva



P74

		€		
1100 mm	2000 g	61,63	1	P74

Canivete de poda



P20

		€		
190 mm	100 g	48,11	6	P20

TESOURAS

Tesoura tamanho pequeno



FS-5

€		
16,31	10	FS-5

Tesoura de relva



P75

		€		
1000 mm	1900 g	60,53	1	P75

Canivete multi-usos



K-AP-1

	€		
90 g	31,44	10	K-AP-1

Tesoura tamanho médio



FS-8

€		
22,20	10	FS-8

Tesoura tamanho grande



FS-7.5

€ 27,39 10 FS-7.5

SERROTE DE ARCO

Serrote de arco ERGO™ com folha para madeira verde/seca. 23: ferskt virke/51:tørt virke



ergo



10

			€		
530 mm	21 in	5	15,49	10-21-51	
607 mm	24 in	5	16,64	10-24-23	
607 mm	24 in	5	16,63	10-24-51	
759 mm	30 in	5	18,81	10-30-23	
759 mm	30 in	5	20,24	10-30-51	

23: ferskt virke/51:tørt virke

Serrote de arco com folha



ergo



332

			€		
530 mm	21 in	5	18,34	332-21-51	

Serrote de arco. -23: raker toothed blade



SE -15-16

			€		
530 mm	21 in	5	8,53	SE-16-21	
530 mm	21 in	5	7,37	SE-16-21-23	
607 mm	24 in	5	8,38	SE-15-24	
759 mm	30 in	5	8,90	SE-15-30	
759 mm	30 in	5	8,98	SE-15-30-23	
810 mm	32 in	5	9,82	SE-15-32	
912 mm	36 in	5	10,45	SE-15-36	
912 mm	36 in	5	10,40	SE-15-36-23	

-23: raker toothed blade

Serrote de arco com folha



331-21

			€		
530 mm	21 in	5	15,49	331-21-51-KP	

Serrote de arco convencional com folha rotativa



3-24-51

			€		
607 mm	24 in	5	18,45	3-24-51	

Serrote de arco convencional com folha rotativa



2-21-51

			€		
530 mm	21 in	5	16,35	2-21-51	

Serrote de arco com folha rotativa



333

			€		
350 mm	14 in	5	29,45	333	



Serrote de arco



14-24

Diagram	Diagram	€	Icons	Code
607 mm	24 in	21,28	5	14-24-3810

Lâmina para serrote de arco - madeira verde



23

Diagram	Diagram	€	Icons	Code
378 mm	13.33 in	2,73	10	23-15
530 mm	20.75 in	4,83	10	23-21
607 mm	24 in	5,16	10	23-24
759 mm	30 in	5,78	10	23-30
810 mm	28.57 in	6,00	10	23-32
912 mm	36 in	6,38	10	23-36

Serrote de poda tipo canivete Dente XT



PG-72

Diagram	Diagram	€	Icons	Code
190 mm	7	17,80	4	PG-72

Serrote de arco - madeira e metais



9-12

Diagram	Diagram	€	Icons	Code
320 mm	12 in	18,52	5	9-12-51/3806-KP

Lâmina Serrote Arco - Madeira Verde



333-5

Diagram	Diagram	€	Icons	Code
350 mm	13-3/4 in	7,29	10	333-5

Serrote de poda - tipo canivete



396-LAP

Diagram	g	€	Icons	Code
190 mm	200 g	38,44	10	396-LAP
190 mm	44 g	15,88	100	396-BLADE
190 mm	44 g	14,52	1	396-BLADE-1P

Lâmina para serrote de arco - madeira seca



51

Diagram	Diagram	€	Icons	Code
320 mm	12-1/2 in	3,58	10	51-12
530 mm	20.75 in	4,83	10	51-21
607 mm	24 in	5,16	10	51-24
759 mm	30 in	5,78	10	51-30
810 mm	28.57 in	6,00	10	51-32
912 mm	36 in	6,23	10	51-36

SERROTES DE PODA

Serrote de poda



349

Diagram	Diagram	€	Icons	Code
300 mm	7	18,67	4	349

Serrote de poda tipo canivete - dente JS



396-JS

Diagram	Diagram	€	Icons	Code
190 mm	5	23,50	4	396-JS

Serrete de poda tipo canivete - dente japonês JT



396-JT



		€		
190 mm	7	23,50	4	396-JT

Serrete de poda com bolsa - dente JS



51-JS



		€		
240 mm	5	51,03	4	5124-JS-H
280 mm	5	57,25	4	5128-JS-H

Lâminas de substituição para serrete de poda 51-JS



5724-JS/5728-JS

		€		
240 mm	5	34,24	1	5724-JS
280 mm	5	39,31	1	5728-JS

Serrete de poda tipo canivete - dente XT



396-HP



		€		
190 mm	7	19,98	4	396-HP

Serrete de poda - dente japonês JT



41-JT



		€		
240 mm	7	23,50	4	4124-JT-H
280 mm	7	28,21	4	4128-JT-H

Lâminas de substituição. Para serrete de poda com dente japonês 41-JT



4724-JT/4728-JT

		€		
240 mm	7	17,63	1	4724-JT
280 mm	7	18,21	1	4728-JT

Para serrete de poda com dente japonês 41-JT

Serrete de poda cabo madeira



4211-4212-



		€		
280 mm	6	17,63	4	4211-11-6T
360 mm	6	19,98	4	4211-14-6T
280 mm	6	17,63	4	4212-11-6T
360 mm	6	19,98	4	4212-14-6T

Conjunto de faca e serra dobrável



LAP-KNIFE



	g	€		
329 g		41,50	10	LAP-KNIFE

396-LAP
2444-LAP

Lâmina sobresselente para serra 396-JS



396-JS-BLADE

		€		
190 mm	5	21,15	300	396-JS-BLADE



Lâmina sobresselente para serra 396-JT



396-JT-BLADE

		€		
190 mm	7	21,15	300	396-JT-BLADE

Lâmina sobresselente para serra 396-HP



396-HP-BLADE

		€		
190 mm	7	12,92	300	396-HP-BLADE

Lâmina de substituição para serrote de poda. 4211, 4212, 339 e 340 e tesouras P34-37



4400-/4420-

		€		
280 mm	6	11,45	10	4400-11
360 mm	6	12,92	10	4400-14
280 mm	6	11,45	10	4420-11
360 mm	6	12,92	10	4420-14
280 mm	6	9,99	10	4400-11-BULK
360 mm	6	11,16	10	4400-14-BULK
280 mm	6	9,99	10	4420-11-BULK
360 mm	6	11,16	10	4420-14-BULK

4211, 4212, 339 e 340 e tesouras P34-37

PEÇAS SOBRESSELENTES E ACESSÓRIOS

Lâmina supl. curva p/serrote c/vara telesc., crt fino



AS-F-BLADE

		€		
330 mm	7	32,91	15	AS-C33-JT-F

Lâmina supl. curva p/serrote c/vara telesc., crt médio



AS-M-BLADE

		€		
360 mm	6.2	35,26	15	AS-C36-JT-M

Lâmina supl. curva p/serrote c/vara telesc., crt grosso



AS-C-C-BLADE

		€		
390 mm	5.4	35,26	15	AS-C39-JT-C
450 mm	5.4	41,13	15	AS-C45-JT-C

ACESSÓRIOS E MANUTENÇÃO

Pedra de afiar sintética, grão 180 e 500



LS-COMBINESS

	€		
100 mm	12,94	1	LS-COMBINESS

Pedra de afiar sintética, grão 400



LS-CORINDON

	€		
100 mm	15,43	1	LS-PIERRE CORINDON

Afiador multi-usos



SHARP-X

	€		
100 mm	23,25	10	SHARP-X
100 mm	697,29	1	SHARP-X-DISP

Pedra de afiar sintética, grão 180



LS-PIERRE-FAUX



230 mm

€

16,39



1 LS-PIERRE-FAUX

Pedra para afiar sintética tipo "Carbor", grão 220. Tipo "Carbor", grão 220



LS-6160-23



230 mm

€

8,94



1 LS-6160-23

Tipo "Carbor", grão 220

Lubrificante - 50 ml



LUB-2015



60 g

€

19,96



6 LUB-2015





BAHCO



Ferramentas pneumáticas para exteriores



TESOURAS DE PODAR

Tesoura pneumática



9210



30 mm 249,92 1 9210

Lâmina para tesoura pneumática 9210



9210-1



9210 82 g 54,23 1 9210-1

Cabeça cortante para tesoura pneumática



9210-10



9210 212 g 101,79 1 9210-10

Conjunto de O-Rings para Tesoura Pneumática



9210-20



9210 28 g 13,99 1 9210-20

Casquilhos de latão para tesoura pneumática 9210



9210-1720100



9210 55.3 g 11,14 1 9210-1720100

Redentor para pistón para tesoura pneumática 9210



9210-1230235



9210 6.7 g 7,85 1 9210-1230235

Pistón para tesoura pneumática 9210



9210-1690148



9210 22 g 19,28 1 9210-1690148

Amortecedores para tesoura pneumática 9210



9210-1730107



9210 176 g 13,41 10 9210-1730107

Molas de substituição para tesoura pneumática 9210



9210-1640142



9210 26.6 g 8,45 1 9210-1640142

Vareta de acoplamento para tesoura pneumática 9210



9210-1700118

		€		
9210	41 g	40,84	1	9210-1700118

Parafusos autorroscantes para tesoura pneumática 9210



9210-1060238

		€		
9210	10 g	0,47	20	9210-1060238

Parafusos TCCE. 9210



9210-1060177

		€		
9210	7 g	0,90	1	9210-1060177

9210

Passadores para tesoura pneumática 9210



9210-1770106

		€		
9210	1000 g	5,62	10	9210-1770106

Tampa frontal



9210-1830137

		€		
9210	9.5 g	8,95	1	9210-1830137

protector de mão



9210-1320281

		€		
9210	35 g	9,03	10	9210-1320281

Junta de protecção para o pé



9210-1230219

		€		
9210	8.6 g	6,78	20	9210-1230219

Corpo da tesoura



9210-1710266

		€		
9210	193 g	66,75	1	9210-1710266





BAHCO



Lindström

CORTADORES DE PRECISÃO

CORTADORES DIAGONAIS

Alicate de corte diagonal. Cabeça oval



ergo®



RX 8130-RX 8162

		€			
0.00-0.04 / 0.2-1.0	Micro-Bevel®	77,30	10	RX 8130	
0.00-0.04 / 0.1-1.0	Flush	82,80	10	RX 8131	
0.00-0.03 / 0.1-0.8	Ultra-Flush®	95,60	10	RX 8132	
0.00-0.05 / 0.2-1.25	Micro-Bevel®	68,20	10	RX 8140	
0.00-0.05 / 0.1-1.25	Flush	74,78	10	RX 8141	
0.00-0.04 / 0.1-1.0	Ultra-Flush®	79,29	10	RX 8142	
0.01-0.06 / 0.3-1.6	Micro-Bevel®	80,23	10	RX 8150	
0.00-0.06 / 0.2-1.6	Flush	87,12	10	RX 8151	
0.00-0.05 / 0.2-1.25	Ultra-Flush®	86,74	10	RX 8152	
0.02-0.08 / 0.4-2.0	Micro-Bevel®	76,25	10	RX 8160	
0.01-0.08 / 0.3-2.0	Flush	92,48	10	RX 8161	
0.01-0.06 / 0.3-1.6	Ultra-Flush®	101,46	10	RX 8162	

Cabeça oval

Alicate de corte diagonal. Cabeça oval



8130-8162

		€			
0.01-0.04 / 0.2-1.0	Micro-Bevel®	49,23	10	8130	
0.00-0.04 / 0.1-1.0	Flush	26,21	10	8131	
0.00-0.03 / 0.1-0.8	Ultra-Flush®	65,11	10	8132	
0.01-0.05 / 0.2-1.25	Micro-Bevel®	51,44	10	8140	
0.00-0.05 / 0.1-1.25	Flush	50,35	10	8141	
0.00-0.04 / 0.1-1.0	Ultra-Flush®	57,57	10	8142	
0.01-0.06 / 0.3-1.6	Micro-Bevel®	64,12	10	8150	
0.01-0.06 / 0.2-1.6	Flush	54,72	10	8151	
0.00-0.05 / 0.1-1.25	Ultra-Flush®	70,17	10	8152	
0.02-0.08 / 0.4-2.0	Micro-Bevel®	61,61	10	8160	
0.01-0.08 / 0.3-2.0	Flush	65,15	10	8161	
0.01-0.08 / 0.3-1.6	Ultra-Flush®	75,68	10	8162	
0.00-0.04 / 0.1-1.0	Flush	71,50	10	8131 CO	
0.01-0.05 / 0.2-1.25	Micro-Bevel®	72,45	10	8140 CO	
0.00-0.05 / 0.1-1.25	Flush	52,69	10	8141 CO	
0.00-0.04 / 0.1-1.0	Ultra-Flush®	77,68	10	8142 CO	
0.01-0.06 / 0.3-1.6	Micro-Bevel®	74,53	10	8150 CO	
0.01-0.06 / 0.2-1.6	Flush	52,31	10	8151 CO	
0.02-0.08 / 0.4-2.0	Micro-Bevel®	77,30	10	8160 CO	
0.01-0.08 / 0.3-2.0	Flush	83,74	10	8161 CO	

Cabeça oval

Cortadores diagonais de precisão longa com cabeça oval e cabo seguro ESD



HS 8130-HS 8162

		€			
0.2-1.25 mm	Micro-Bevel®	73,48	1	HS 8130	
0.1-1.25 mm	Flush	76,33	1	HS 8131	
0.1-0.8 mm	Ultra-Flush®	84,92	1	HS 8132	
0.2-1.25 mm	Micro-Bevel®	69,59	10	HS 8140	
0.1-1.25 mm	Flush	72,51	10	HS 8141	
0.1-1.0 mm	Ultra-Flush®	80,15	10	HS 8142	
0.3-1.6 mm	Micro-Bevel®	73,94	1	HS 8150	
0.2-1.6 mm	Flush	72,10	10	HS8151	
0.1-1.25 mm	Ultra-Flush®	83,46	10	HS8152	
0.4-2.0 mm	Micro-Bevel®	76,33	10	HS 8160	
0.3-2.0 mm	Flush	84,44	10	HS 8161	
0.3-2.0 mm	Ultra-Flush®	95,89	10	HS 8162	

Cortadores diagonais de precisão ERGO™ com cabeça afunilada



ergo®



RX 8133-RX 8165

		€			
0.008-0.04 / 0.2-1.0	Micro-Bevel®	66,95	10	RX8133	
0.004-0.03 / 0.1-0.8	Flush	66,95	10	RX8134	
0.004-0.02 / 0.1-0.5	Ultra-Flush®	66,95	10	RX8135	
0.01-0.05 / 0.2-1.25	Micro-Bevel®	82,98	10	RX 8143	
0.00-0.05 / 0.1-1.25	Flush	81,27	10	RX 8144	
0.00-0.04 / 0.1-1.0	Ultra-Flush®	81,23	10	RX 8145	
0.01-0.06 / 0.3-1.6	Micro-Bevel®	33,55	10	RX 8153	
0.01-0.06 / 0.2-1.6	Flush	33,55	10	RX 8154	
0.01-0.05 / 0.2-1.25	Ultra-Flush®	131,14	10	RX8155	
0.02-0.08 / 0.4-2.0	Micro-Bevel®	57,59	10	RX8163	
0.01-0.08 / 0.3-2.0	Flush	113,38	10	RX 8164	
0.01-0.06 / 0.3-1.6	Ultra-Flush®	116,12	10	RX 8165	

Cortadores diagonais de precisão com cabeça afunilada



8133-8165

		€			
0.008-0.04 / 0.2-1.0	Micro-Bevel®	49,81	10	8133	
0.004-0.03 / 0.1-0.8	Flush	49,81	10	8134	
0.004-0.02 / 0.1-0.5	Ultra-Flush®	49,81	10	8135	
0.01-0.05 / 0.2-1.25	Micro-Bevel®	52,17	10	8143	
0.01-0.05 / 0.2-1.25	Flush	49,23	10	8144	
0.00-0.04 / 0.1-1.0	Ultra-Flush®	71,75	10	8145	
0.01-0.06 / 0.3-1.6	Micro-Bevel®	27,76	10	8153	
0.01-0.06 / 0.2-1.6	Flush	68,58	10	8154	
0.01-0.05 / 0.2-1.25	Ultra-Flush®	83,57	10	8155	
0.02-0.08 / 0.4-2.0	Micro-Bevel®	53,34	10	8163	
0.01-0.08 / 0.3-2.0	Flush	85,62	10	8164	
0.01-0.06 / 0.3-1.6	Ultra-Flush®	100,61	10	8165	
0.01-0.05 / 0.2-1.25	Flush	75,58	10	8144 CO	
0.01-0.06 / 0.2-1.6	Flush	73,96	10	8154 CO	
0.02-0.08 / 0.4-2.0	Micro-Bevel®	70,77	10	8163 CO	
0.01-0.06 / 0.3-1.6	Ultra-Flush®	115,10	10	8165 CO	

Alicate de corte diagonal. Cabeça cônica



7190-7191

		€			
0.00-0.04 / 0.2-1.0	Micro-Bevel®	61,47	10	7190	
0.00-0.04 / 0.1-1.0	Flush	59,47	10	7191	
0.00-0.04 / 0.2-1.0	Micro-Bevel®	67,82	10	7190 CO	
0.00-0.04 / 0.1-1.0	Flush	72,90	10	7191 CO	

Cabeça cônica

Cortadores diagonais de precisão longa com cabeça afunilada e cabo seguro ESD



HS 8133-HS 8165

		€		
0.2-1.0 mm	Micro-Bevel®	63,48	1	HS8133
0.1-0.8 mm	Flush	63,48	1	HS8134
0.1-0.5 mm	Ultra-Flush®	63,48	1	HS8135
0.2-1.25 mm	Micro-Bevel®	75,87	10	HS 8143
0.2-1.25 mm	Flush	77,78	10	HS 8144
0.1-1.0 mm	Ultra-Flush®	81,11	10	HS 8145
0.3-1.6 mm	Micro-Bevel®	89,41	10	HS8153
0.2-1.6 mm	Flush	77,25	10	HS8154
0.2-1.25 mm	Ultra-Flush®	77,25	1	HS8155
0.3-2.0 mm	Micro-Bevel®	81,11	10	HS 8163
0.3-2.0 mm	Flush	54,08	10	HS 8164
0.3-1.6 mm	Ultra-Flush®	101,34	10	HS8165

Cortadores diagonais longos com cabeça afunilada e cabo seguro ESD



HS 7190-HS 7191

		€		
0.2-1.0 mm	Micro-Bevel®	60,11	1	HS7190
0.1-1.0 mm	Flush	60,11	1	HS7191

Cortadores diagonais de precisão ERGO™ com cabeça afunilada e suave



RX 8136-RX 8168

		€		
0.004-0.03 / 0.1-0.8	Micro-Bevel®	66,95	10	RX8136
0.004-0.03 / 0.1-0.8	Flush	77,50	10	RX 8137
0.004-0.02 / 0.1-0.5	Ultra-Flush®	77,50	10	RX8138
0.01-0.04 / 0.2-1.0	Micro-Bevel®	68,31	10	RX 8146
0.00-0.04 / 0.1-1.0	Flush	83,57	10	RX 8147

		€		
0.00-0.03 / 0.1-0.8	Ultra-Flush®	93,25	10	RX 8148
0.01-0.05 / 0.3-1.25	Micro-Bevel®	61,11	10	RX 8156
0.01-0.05 / 0.2-1.25	Flush	74,80	10	RX 8157
0.01-0.04 / 0.2-1.0	Ultra-Flush®	169,45	10	RX 8158
0.02-0.06 / 0.4-1.5	Micro-Bevel®	57,59	10	RX8166
0.01-0.06 / 0.3-1.5	Flush	128,14	10	RX 8167
0.01-0.05 / 0.3-1.25	Ultra-Flush®	209,74	10	RX 8168

Cortadores diagonais de precisão com cabeça afunilada e cabo seguro ESD



8136-8168

		€		
0.004-0.03 / 0.1-0.8	Micro-Bevel®	49,81	10	8136
0.004-0.03 / 0.1-0.8	Flush	49,81	10	8137
0.004-0.02 / 0.1-0.5	Ultra-Flush®	49,81	10	8138
0.01-0.04 / 0.2-1.0	Micro-Bevel®	47,27	10	8146
0.01-0.04 / 0.1-1.0	Flush	66,11	10	8147
0.00-0.03 / 0.1-0.8	Ultra-Flush®	71,10	10	8148
0.01-0.05 / 0.3-1.25	Micro-Bevel®	70,35	10	8156
0.01-0.05 / 0.2-1.25	Flush	72,61	10	8157
0.01-0.04 / 0.2-1.0	Ultra-Flush®	80,45	10	8158
0.02-0.06 / 0.4-1.5	Micro-Bevel®	149,97	10	8166L
0.01-0.06 / 0.3-1.5	Flush	173,60	10	8167L
0.01-0.05 / 0.3-1.25	Ultra-Flush®	173,60	10	8168L
0.00-0.03 / 0.1-0.8	Ultra-Flush®	86,32	10	8148 CO

Cortadores diagonais de precisão longa com cabeça afunilada e aliviada e punho seguro ESD



HS 8136-HS 8168

		€		
0.1-0.8 mm	Micro-Bevel®	63,48	1	HS8136
0.1-0.8 mm	Flush	63,48	1	HS8137
0.1-0.5 mm	Ultra-Flush®	63,48	1	HS8138
0.2-1.0 mm	Micro-Bevel®	77,50	10	HS8146
0.1-1.0 mm	Flush	77,50	10	HS8147

		€		
0.1-0.8 mm	Ultra-Flush®	84,44	10	HS 8148
0.3-1.25 mm	Micro-Bevel®	82,40	1	HS8156
0.2-1.25 mm	Flush	82,40	1	HS8157
0.2-1.0 mm	Ultra-Flush®	82,40	1	HS8158
0.4-1.5 mm	Micro-Bevel®	92,70	1	HS8166
0.3-1.5 mm	Flush	92,70	1	HS8167
0.3-1.25 mm	Ultra-Flush®	92,70	1	HS8168

CORTADORES DIAGONAIS, CABEÇA ÚNICA

Cortadores diagonais de precisão ERGO™ com cabeça afunilada e suave



RX8137MX-RX8138MX

		€		
0.1-0.8 mm	Flush	77,50	10	RX8137MX
0.1-0.8 mm	Ultra-Flush®	59,63	10	RX8138MX

OBLIQUO - CORTADORES FINAIS

Alicate de corte oblíquo



7290-7291

		€		
0.01-0.03 / 0.35-0.8	Micro-Bevel®	68,21	10	7290
0.01-0.03 / 0.35-0.8	Flush	71,83	10	7291

Cortadores de extremidades oblíquas de precisão longa de 11°, 0,35 mm-1,25 mm



HS 7290-HS 7291

		€		
0.01-0.03 / 0.35-0.8	Micro-Bevel®	60,11	1	HS7290
0.01-0.03 / 0.35-0.8	Flush	69,59	1	HS7291

Alicate de corte frontal. Série suprema



7292

		€		
0.01-0.03 / 0.35	Flush	45,06	10	7292

Série suprema

Cortadores de extremidades oblíquas de precisão longa com cabeça em miniatura



HS 7292

		€		
0.01-0.03 / 0.35-0.8	Flush	73,58	10	HS7292

Alicate de corte oblíquo



7293

		€		
0.01-0.03 / 0.35-0.8	Flush	81,83	10	7293

Cortadores de extremidades oblíquas de precisão longa de 11°, 0,35 mm-1 mm



HS 7293

		€		
0.01-0.04 / 0.35-1.0	Flush	60,11	1	HS7293

ÂNGULO

Alicate de corte oblíquo 20°. Cabeça curta



RX 8211

		€		
0.01-0.05 / 0.2-1.2	Flush	136,03	10	RX 8211

Cabeça curta

Alicate de corte oblíquo 20°. Cabeça curta



8211

		€		
0.01-0.05 / 0.2-1.2	Flush	80,57	10	8211

Cabeça curta

Cortadores oblíquos de cabeça curta de precisão longa de 20°, 0,2 mm-1,2 mm



HS 8211

		€		
0.01-0.05 / 0.2-1.2	Flush	137,11	10	HS8211

Alicate de corte oblíquo 45°. Cabeça longa



RX 8247

		€		
0.01-0.04 / 0.2-1.0	Flush	84,26	10	RX 8247

Cabeça longa

Alicate de corte oblíquo 45°. Cabeça longa



8247

		€		
0.01-0.04 / 0.2-1.0	Flush	84,26	10	8247
0.01-0.04 / 0.2-1.0	Flush	124,81	10	8247 CO

Cabeça longa

Cortadores oblíquos com cabeça cônica 45° de precisão longa 0,2 mm-1 mm



HS 8247

		€		
0.01-0.04 / 0.2-1.0	Flush	123,56	1	HS 8247

Alicate de corte oblíquo 45°. Cabeça longa, em relevo



ergo®



RX 8248

		€		
0.01-0.03 / 0.2-0.8	Flush	149,17	10	RX 8248

Cabeça longa, em relevo

Alicate de corte oblíquo 45°. Ângulo reverso



7285

		€		
0.2-1.0 mm	Flush	82,28	10	7285

Ângulo reverso

Cortadores oblíquos de cabeça cônica e aliviada de 45° de precisão longa 0,2 mm-0,8 mm



HS 8248

		€		
0.01-0.03 / 0.2-0.8	Flush	128,81	10	HS 8248

Alicate de corte oblíquo. Ângulo reverso



7280

		€		
0.01-0.03 / 0.2-0.8	Flush	74,93	10	7280

Ângulo reverso

Cortadores oblíquos 45° de precisão longa 0,2 mm-1 mm



HS 7285

		€		
0.01-0.04 / 0.2-1.0	Flush	60,11	1	HS7285

Alicate de corte oblíquo 45°. Cabeça longa e em relevo



8248

		€		
0.01-0.03 / 0.2-0.8	Flush	97,85	10	8248
0.00-0.03 / 0.2-0.8	Flush	33,12	10	8249
0.01-0.03 / 0.2-0.8	Flush	133,10	10	8248 CO

Cabeça longa e em relevo

Cortadores oblíquos de precisão longa de 0,2 mm-08 mm



HS 7280

		€		
0.01-0.03 / 0.2-0.8	Flush	60,11	1	HS7280

CORTADORES DE PLÁSTICO

Alicate de corte lateral - fosfatado. ESD, plástico



ergo®



P6160

		€		
1.5 mm	Flush	75,00	10	P6160

ESD, plástico

CORTADOR DE PONTA

Alicate de corte diagonal. Corte de pontas



ergo®



RX 8149

		€		
0.01-0.02 / 0.1-0.6	Flush	171,21	10	RX 8149

Corte de pontas

Alicate de corte diagonal. Cabeça de ponta



8149

		€		
0.00-0.02 / 0.1-0.6	Flush	132,53	10	8149

Cabeça de ponta

Cortadores de pontas diagonais de precisão longa com cabo seguro ESD



HS 8149

		€		
0.01-0.02 / 0.1-0.6	Flush	66,95	1	HS8149

CORTADORES OBLÍQUOS, CABEÇA ÚNICA

Alicate de corte oblíquo 45°. Cabeça longa e em relevo



8248Q

		€		
0.00-0.03 / 0.2-0.8	Ultra-Flush®	86,40	10	8248Q

Cabeça longa e em relevo

Alicate de corte frontal. Série suprema



7292G

		€		
0.01-0.03 / 0.35	Flush	125,54	10	7292G

Série suprema

MICRO TIP CUTTERS

Alicate de corte micro



ergo®



RX 8233

		€		
0.004-0.024 / 0.1-0.6	Flush	198,15	10	RX8233A

Alicate de corte micro



ergo®



RX 8234

		€		
0.002-0.018 / 0.05-0.4	Flush	185,76	10	RX8234A

Alicate de corte micro



ergo®



RX 8237

		€		
0.004-0.02 / 0.1-0.5	Flush	185,75	10	RX8237A

TESOURAS MULTIUSO

Alicate multifunções



HS6000

		€		
Kevlar	Flush	75,87	10	HS6000
Kevlar	Flush	57,30	10	HS6001

ACESSÓRIOS E PEÇAS DE REPOSIÇÃO

Captador de chumbo



813/814/816

	€		
8130-8132, Rx 8130-8132	6,00	1	813
8140-8148, Rx 8140-8148	4,52	1	814
8130-8132, 8140-8148	9,70	1	816

Mola de retorno - Série RX



RX 01

g	€		
5g	6,29	1	RX 01

Molas de retorno para as séries 80, Supreme e HS



8130-50/8160

g	€		
1g	3,52	1	8130-50/SUPR SPRING
1g	3,96	1	8160/SPRING

CORTADORES DE PRECISÃO PARA MATERIAIS DÚROS

CORTADORES DE CARBONETO

Cortadores diagonais de carboneto de precisão com cabeça cônica para materiais duros



7154 TC

	€		
0.1-0.9 mm	226,53	10	7154TC

CORTADORES DIAGONAIS ESPECÍFICOS DO DESEMPENHO

Cortadores diagonais específicos para desempenho de precisão ERGO™ com cabeça oval



ergo



RX 8140PS-RX 8161PS

	€		
0.01-0.04 / 0.1-1.0 Micro-Bevel®	116,21	10	RX8140PS
0.01-0.04 / 0.1-1.0 Flush	39,10	10	RX8141PS
0.01-0.04 / 0.1-1.0 Micro-Bevel®	73,90	10	RX 8142PS
0.01-0.04 / 0.1-1.0 Micro-Bevel®	92,13	10	RX8150PS
0.01-0.06 / 0.3-1.6 Flush	52,26	10	RX 8161PS

CORTADORES DIAGONAIS EXTRA ENDURECIDOS

Cortadores diagonais extra endurecidos de precisão ERGO™ com cabeça oval



ergo



RX 8140M2-8160M2

	€		
0.01-0.05 / 0.4-2.0 Micro-Bevel®	116,21	10	RX8140M2
0.01-0.06 / 0.4-2.0 Micro-Bevel®	48,32	10	RX8150M2
0.02-0.08 / 0.4-2.0 Micro-Bevel®	183,94	10	RX8160M2

Cortadores diagonais específicos de desempenho de precisão com cabeça oval e cabo seguro ESD para materiais duros



8140PS-8161PS

	€		
0.01-0.04 / 0.1-1.0 Micro-Bevel®	36,70	10	8140PS
0.01-0.04 / 0.1-1.0 Flush	84,11	10	8141PS
0.00-0.05 / 0.1-1.25 Micro-Bevel®	43,39	10	8150PS
0.01-0.06 / 0.3-1.6 Micro-Bevel®	53,93	10	8160PS
0.01-0.06 / 0.3-1.6 Flush	52,90	10	8161PS

Cortadores diagonais extra endurecidos de precisão com cabeça oval e cabo seguro ESD para materiais duros



8140M2-8160M2

	€		
0.01-0.05 / 0.4-2.0 Micro-Bevel®	45,40	10	8140M2
0.01-0.06 / 0.4-2.0 Micro-Bevel®	56,07	10	8150M2
0.02-0.08 / 0.4-2.0 Micro-Bevel®	74,40	10	8160 M2

Cortadores diagonais de precisão ERGO™ com cabeça afunilada e cabo seguro em ESD para materiais duros



ergo



RX8143PS-RX 8147PS

	€		
0.01-0.04 / 0.1-1.0 Flush	70,13	10	RX8143PS
0.004-0.03 / 0.1-0.8 Flush	93,60	10	RX 8147PS

CORTADORES DIAGONAIS ESPECÍFICOS DE DESEMPENHO, CABEÇA ÚNICA

Cortadores diagonais específicos para desempenho de precisão ERGO™ com cabeça oval



ergo



RX8140PSF-RX8160BPS

0.01-0.04 / 0.1-1.0 Micro-Bevel® € 66,66 10 RX8160BPS

Cortadores diagonais específicos de desempenho de precisão com cabeça oval



8154PSP

0.00-0.05 in Micro-Bevel® € 55,68 10 8154PSP

ALICATE DE FIXAÇÃO DE PRECISÃO

NARIZ ACHATADO

Alicate ponta chata



7490

		€		
20 mm	S	52,08	10	7490
20 mm	S	62,78	10	7490 CO

Alicate de ponta chata



ergo



RX 7490

		€		
20 mm	S	68,31	10	RX 7490

Alicates de pontas planas e longas com pega sintética de dois componentes



HS 7490

	€		
S	101,13	10	HS7490

NARIZ REDONDO

Alicate de ponta redonda



ergo



RX 7590

		€		
20 mm	S	68,62	10	RX 7590

Alicate de ponta redonda



7590-7591

		€		
20 mm	S	52,25	10	7590
20 mm	S	68,41	10	7590 CO
38.5 mm	M	26,99	1	7591

Alicates de pontas redondas e longas com cabo sintético



HS 7590

	€		
S	69,65	1	HS 7590

NARIZ DE CADEIA

Alicate de pontas semi-redondas dobradas



ergo



RX 7892

IT	Icon	€	Box	Icon
29 mm	M	80,54	10	RX 7892

Alicates de pontas longas com pega sintética de dois componentes



HS 7890-HS 7891

Icon	€	Box	Icon
M	68,70	1	HS 7890
M	69,17	10	HS 7891

NARIZ DOBRADO

Alicate de pontas semi-redondas e dobradas



7892

IT	Icon	€	Box	Icon
20 mm	M	65,32	10	7892
20 mm	M	57,10	10	7892 CO

Alicates pontas semi-redondas. RX 7890 com maxilas lisas e RX 7891 com maxilas serrilhadas



ergo



RX 7890-RX 7891

IT	Icon	€	Box	Icon
32 mm	S	72,15	10	RX 7890
32 mm	S	67,19	10	RX 7891

RX 7890 com maxilas lisas e RX 7891 com maxilas serrilhadas

ALICATE DE MALHA METÁLICA

ERGO™ Alicate de precisão para correntes com cabo sintético



ergo



RX 7390

IT	Icon	€	Box	Icon
11 mm	S	63,09	10	RX 7390

Alicates de pontas dobradas de 60° longo com cabo sintético



HS 7892

Icon	€	Box	Icon
M	72,99	1	HS 7892

Alicate pontas semi-redondas. 7890 com maxilas lisas e 7891 com maxilas serrilhadas



7890-7891

IT	Icon	€	Box	Icon
32.5 mm	M	55,62	10	7890
32.5 mm	M	54,77	10	7891
32.5 mm	M	68,41	10	7890 CO
32.5 mm	M	62,48	10	7891 CO

7890 com maxilas lisas e 7891 com maxilas serrilhadas

Alicate de precisão de cota de malha de ponta plana oblíqua ERGO™ com cabo sintético



ergo



RX 7392

IT	Icon	€	Box	Icon
12 mm	S	63,09	10	RX 7392

NARIZ SNIPE

Alicate de pontas semi-redondas curtas



ergo



RX 7893

IT	Icon	€	Box	Icon
20 mm	S	74,27	10	RX 7893

Alicates de pontas semi-redondas curtas



7893

		€		
20 mm	S	53,55	10	7893

Alicates de pontas curtas e compridas com cabo sintético



HS 7893

	€		
S	103,04	1	HS 7893

NARIZ DE SNIPE, CABEÇA ÚNICA

Alicates de pontas semi-redondas curtas



7893K

		€		
20 mm	S	53,65	10	7893K

NARIZ DE AGULHA

Alicates de precisão para agulhas ERGO™ com mandíbulas lisas



ergo®



RX 7894

	€		
L	66,73	10	RX 7894

Alicates de pontas de agulha longas com cabo sintético



HS 7894

	€		
L	89,02	1	HS7894

Alicates de precisão com ponta de agulha e mandíbulas lisas e cabo seguro ESD



7894

	€		
L	26,06	10	7894

ALICATES PRECISÃO

ALICATES CABEÇA CÔNICA

Fresa de micro-corte com cabeça cônica



6151

		€		
Micro Edge	0.2-1.6/0.01-0.06	22,99	10	6151

Fresa de corte de bordo com cabeça cônica



6152

		€		
Flush Edge	0.2-1.6/0.01-0.06	23,90	10	6152

Fresa de lâmina de aço inoxidável com cabeça cônica



6152SS

		€		
Flush Edge	0.2-1.6/0.01-0.06	27,90	10	6152SS

CABEÇA PONTIAGUDA

Fresa de ponta com cabeça pontiaguda



6159



		€		
Flush Edge	0.2-1.0/0.01-0.039	27,90	10	6159

ALICATE DE CABEÇA OBLÍQUA

Fresa de corte com cabeça oblíqua



6258



		€		
Flush Edge	0.2-1.0/0.01-0.039	27,90	10	6258

CHAVES DE FENDA DE PRECISÃO

SEGURANÇA ESD

Chaves de fendas de precisão com segurança ESD 1,5-3,0 mm



800ESD

		€		
1.5 mm	50 mm	3,89	10	800-1.5-50ESD
2.0 mm	50 mm	5,92	10	800-2-50ESD
2.5 mm	50 mm	3,38	10	800-2.5-50ESD
3.0 mm	50 mm	3,21	10	800-3-50ESD

Chaves de fendas Phillips de precisão com segurança ESD PH00-PH1



801ESD

		€		
PH00	50 mm	4,79	10	801-00-50ESD
PH0	50 mm	4,11	10	801-0-50ESD
PH1	75 mm	4,50	10	801-1-75ESD

Chaves de fendas de precisão TORX® ESD Safe T6-T20



803ESD

		€		
T6	50 mm	5,62	10	803-6-50ESD
T7	50 mm	5,86	10	803-7-50ESD
T8	50 mm	5,93	10	803-8-50ESD
T9	50 mm	7,58	10	803-9-50ESD
T10	50 mm	7,58	10	803-10-50ESD
T15	75 mm	7,67	10	803-15-75ESD
T20	75 mm	7,73	10	803-20-75ESD

Conjunto de chaves de fendas de precisão Pentalobe com segurança ESD TS1-TS5



805ESD

		€		
TS1	50 mm	8,35	10	805-TS1-50ESD
TS4	50 mm	6,33	10	805-TS4-50ESD
TS5	50 mm	8,90	10	805-TS5-50ESD

Conjunto de chaves de fendas/Phillips de precisão com segurança ESD 1,5-3,0 mm/ PH00-PH1 - 7 peças



801-7ESD

	€		
7	39,86	1	801-7ESD

800-1.5-50ESD, 800-2-50ESD, 800-2.5-50ESD, 800-3-50ESD

801-00-50ESD, 801-0-50ESD, 801-1-75ESD

Conjunto de chaves de fendas de precisão TORX® ESD Safe T6-T20 - 7 unidades



803-7ESD

	€		
7	41,10	1	803-7ESD

803-6-50ESD, 803-7-50ESD, 803-8-50ESD, 803-9-50ESD, 803-10-50ESD, 803-15-75ESD, 803-20-75ESD

▶ DESCASCADORES DE FIOS

CORTADORES DIAGONAIS

Alicate de corte diagonal. Cabeça oval



8150SK

		€		
0.01-0.06 / 0.3-1.6	Micro-Bevel®	71,02	10	8150 SK

Cabeça oval

Alicate de corte diagonal. Cabeça oval



8150J-8160J

		€		
0.02 / 0.5	Micro-Bevel®	106,66	10	8150 J
Max0.02 / Max	Micro-Bevel®	125,97	10	8160 J

Cabeça oval

▶ ALICATES DE CORTE PARA TRABALHOS PESADOS

CORTADOR DIAGONAL

Alicate de corte lateral - fosfatado. Arame de piano e Arame de cobre



TRX 8180

		€		
4.5 mm	2.5 mm	56,51	5	TRX 8180

Arame de piano e Arame de cobre

▶ FERRAMENTAS DE TORQUE

CHAVES DE FENDA DE TORQUE

Chave de parafusos dinamoétrica ajustável com escala em janela e segurança contra descargas eletrostáticas



MA500-1A - MA500-3A

		€		
16-80 cNM	1/4 in	273,26	1	MA500-1A
40-200 cNM	1/4 in	279,60	1	MA500-2A
90-450 cNM	1/4 in	285,74	1	MA500-3A

Chave de parafusos dinamoétrica com pré-regulação, escala em janela e segurança contra descargas eletrostáticas



PS501

		€		
4-22 cNM	1/4 in	197,83	1	PS501-1
7-70 cNM	1/4 in	220,37	1	PS501-2
15-170 cNM	1/4 in	227,89	1	PS501-3
45-450 cNM	1/4 in	234,15	1	PS501-4

PINÇAS

CONJUNTOS DE PINÇA

Conjunto de pinças



9855

8 x 200 x 110 mm € 100,74 1 9855

9855W	
TL SS-SA-SL	
TL AA-SA-SL	
TL 2A-SA-SL	
TL 7A-SA-SL	
TL 4-SA-SL	

Conjunto de pinças. 5peças



9857

10 x 200 x 110 mm € 78,72 1 9857

TL 00-SA-SL	
TL 1-SA-SL	
TL 5-SA-SL	
TL 7-SA-SL	
TL 3C-SA-SL	
9855W	

Conjunto de pinças. Ponta fina



9858

8 x 200 x 65 mm € 29,25 1 9858

Ponta fina

9858W	
TL AA-SA-SL	
TL SS-SA-SL	

Conjunto de pinças. Ponta dura



9859

8 x 200 x 65 mm € 67,60 1 9859

Ponta dura

9858W	
TL 00B-SA	
TL 2A-SA-SL	

Conjunto de 5 pinças de alta precisão com ponta estilo 00-SA, 2ASA, 3C-SA, 5-SA, 7-SA



9860

12 x 105 x 185 mm € 154,72 1 9860

Conjunto de 5 pinças económicas Pontas estilo 00-SA, 2A-SA, 3C-SA, 5-SA, 7-SA



9861

10 x 70 x 165 mm € 68,89 1 9861

Conjunto de 4 pontas de pinças económicas estilo 2A-SA, 3C-SA, 7A-SA, AA-SA



9862

10 x 70 x 165 mm € 54,46 1 9862

Conjunto de 5 pontas de pinças SMD e económicas SM103-SA, SM108-SA, 3-SA, 5-SA, 7A-SA



9863

10 x 70 x 165 mm € 92,23 1 9863

PINÇAS DE CORTE

Pinça de corte em aço-carbono Estilo 15A com lâminas angulares



TL 15A

		€		
15A	120 mm	53,54	1	TL 15A

Pinças de corte em aço-carbono, modelo 15AGW, com lâminas predominantemente angulares



TL 15AGW

		€		
15AGW	115 mm	53,46	1	TL 15AGW

Pinça de corte em aço inoxidável, modelo 15AGWHM, com pastilhas de carboneto de tungstênio e lâminas predominantemente angulares



TL 15AGWHM-SA

		€		
15AGHM	115 mm	90,48	1	TL 15AGWHM-SA

PINÇA DE ALTA PRECISÃO

Pinça de alta precisão. Arestas planas, pontas duras, dentes serrilhados



TL 00B-SA

		€		
00B	120 mm	42,47	1	TL 00B-SA

Arestas planas, pontas duras, dentes serrilhados

Pinça de alta precisão. Arestas planas, pontas duras, pontas e dentes serrilhados



TL 00D-SA

		€		
00D	120 mm	42,47	1	TL 00D-SA

Arestas planas, pontas duras, pontas e dentes serrilhados

Pinça de alta precisão. Aresta plana e pontas duras



TL 00-SA

		€		
00	120 mm	38,26	1	TL 00-SA

Aresta plana e pontas duras

Pinça de aço inoxidável de alta precisão estilo 000 com pontas finas



TL 000-SA

		€		
000	120 mm	30,99	1	TL 000-SA

Pinça de alta precisão. Aresta plana e pontas duras



TL 0C9-SA

		€		
0C9	90 mm	36,70	1	TL 0C9-SA

Aresta plana e pontas duras

Pinça de alta precisão. Pontas duras de precisão



TL 1-SA

		€		
1	120 mm	36,70	1	TL 1-SA

Pontas duras de precisão

Pinça de alta precisão. Pontas duras e redondas



TL 2A-SA

		€		
2A	120 mm	37,50	1	TL 2A-SA

Pontas duras e redondas

Pinça de alta precisão. Dentes muito afiados



TL 3C-SA

		€		
3C	110 mm	36,70	1	TL 3C-SA

Dentes muito afiados

Pinça de alta precisão. Pontas muito afiadas



TL 3-SA

		€		
3	120 mm	36,70	1	TL 3-SA

Pontas muito afiadas

Pinça de alta precisão. Pontas extra finas e dobradas



TL 51S-SA

		€		
51S	115 mm	41,21	1	TL 51S-SA

Pontas extra finas e dobradas

Pinça de alta precisão. Pontas extra finas e pontiagudas



TL 5-SA

		€		
5	110 mm	44,49	1	TL 5-SA

Pontas extra finas e pontiagudas

Pinça de alta precisão. Pontas longas, esguias e finas



TL SS-SA

		€		
SS	140 mm	36,70	1	TL SS-SA

Pontas longas, esguias e finas

Pinça de alta precisão. Pontas duras, finas e curvas



TL 7A-SA

		€		
7A	118 mm	47,77	1	TL 7A-SA

Pontas duras, finas e curvas

Pinça de alta precisão. Pontas finas em curva



TL 7-SA

		€		
7	118 mm	47,77	1	TL 7-SA

Pontas finas em curva

Pinça de alta precisão. Pontas extra finas e dobradas



TL 5B-SA

		€		
5B	110 mm	47,77	1	TL 5B-SA

Pontas extra finas e dobradas

Pinça de alta precisão. Pontas longas, finas e curvas



TL 65A-SA

		€		
65A	140 mm	42,85	1	TL 65A-SA

Pontas longas, finas e curvas

Pinças de alta precisão em aço inoxidável, modelo 34A, com cabos serrilhados e pontas lisas, finas, quadradas e planas



TL 34A-SA

		€		
34A	120 mm	40,53	1	TL 34A-SA

Pinça de aço inoxidável de alta precisão Estilo 6 com pontas angulares e muito finas



TL 6-SA

		€		
6	117 mm	40,53	1	TL 6-SA

PINÇAS DE PLÁSTICO COM PONTA SUBSTITUIVEL - FIBRA DE CARBONO

Pinça de plástico de fibra de carbono com ponta substituível e segura para ESD Estilo 242CFR com pontas finas



TL 242CFR-SA

		€		
242CFR	130 mm	26,85	1	TL 242CFR-SA

Pinça com pontas substituíveis de fibra carbono. Aresta plana e pontas grossas



TL 249CFR-SA

		€		
249CFR	130 mm	50,18	1	TL 249CFR-SA

Aresta plana e pontas grossas

Pinça com pontas substituíveis de fibra carbono. Pontas extra finas



TL 259CFR-SA

		€		
259CFR	130 mm	50,18	1	TL 259 CFR-SA

Pontas extra finas

Pinça de plástico PEEK de carbono com ponta substituível, segura contra ESD, estilo 259CPR com pontas finas, pontiagudas e fortes



TL 259CPR-SA

		€		
259CPR	130 mm	28,11	1	TL 259CPR-SA

Pinça de plástico PEEK de carbono com ponta substituível, segura contra ESD, estilo 259CPR com pontas finas, pontiagudas e fortes



TL 259CPR-SA

		€		
259CPR	130 mm	28,11	1	TL 259CPR-SA

Pinça com pontas substituíveis de fibra carbono. Aresta plana e pontas grossas



TL 00CFR-SA

		€		
00CFR	130 mm	50,18	1	TL 00CFR-SA

Aresta plana e pontas grossas

Pinça substituível de plástico PVDF com ponta segura contra ESD, modelo 259SVR, com pontas finas, pontiagudas e fortes



TL 259SVR-SA

		€		
259SVR	130 mm	42,18	1	TL 259SVR-SA

Pinça com pontas substituíveis de fibra carbono. Pontas redondas achatadas



TL 2ACFR-SA

		€		
2ACFR	130 mm	50,18	1	TL 2ACFR-SA

Pontas redondas achatadas

Pinça de plástico de fibra de carbono com ponta substituível e segurança ESD Estilo 5CF com pontas muito finas e afiadas



TL 5CF-SA

		€		
5CF	130 mm	25,72	1	TL 5CF-SA

Pinça com pontas substituíveis de fibra carbono. Pontas extra finas



TL 5CFR-SA

		€		
5CFR	130 mm	50,18	1	TL 5CFR-SA

Pontas extra finas

Pinça de plástico PEEK com ponta substituível, segura contra ESD, estilo 5CPR, com pontas muito finas e afiadas



TL 5CPR-SA

		€		
5CPR	130 mm	28,11	1	TL 5CPR-SA

Pinça substituível de plástico PVDF com protecção ESD, modelo 5SV, com pontas muito finas e afiadas



TL 5SVR-SA

		€		
5SVR	130 mm	28,11	1	TL 5SVR-SA

Pinça de plástico PEEK com ponta substituível para segurança ESD Estilo 7CPR com pontas curvas e muito finas



TL 7CPR-SA

		€		
7CPR	130 mm	28,11	1	TL 7CPR-SA

Pinças de plástico PVDF com ponta substituível e segurança ESD Estilo 7SVR com pontas muito finas e curvas



TL 7SVR-SA

		€		
7SVR	130 mm	28,11	1	TL 7SVR-SA

Pinça com pontas substituíveis de fibra carbono. Pontas finas em curva



TL 7CFR-SA

		€		
7CFR	130 mm	50,18	1	TL 7CFR-SA

Pontas finas em curva

PINÇAS TÁCTEIS ERGONÓMICAS COM SEGURANÇA ESD

Pinça de alta precisão



TL 00-SA-ET

		€		
00-SA	123 mm	45,11	1	TL 00-SA-ET

Pinça ergonómica com segurança ESD em aço inoxidável, modelo 2A, com pontas redondas, planas e muito finas



TL 2A-SA-ET

		€		
2A-SA	123 mm	34,26	1	TL 2A-SA-ET

Pinças - toque suave



TL 3-SA-ET

		€		
3	123 mm	45,11	1	TL 3-SA-ET

Pinça ergonómica de aço inoxidável segura para ESD, modelo 3C, com pontas pontiagudas e finas



TL 3C-SA-ET

		€		
3C-SA	112 mm	34,63	1	TL 3C-SA-ET

Pinça ergonómica com segurança ESD em aço inoxidável Estilo 5 com pontas afiadas e finas



TL 5-SA-ET

		€		
5-SA	112 mm	38,14	1	TL 5-SA-ET

Pinça ergonómica com segurança ESD em aço inoxidável, modelo AA, com pontas afiadas e finas



TL AA-SA-ET

		€		
AA-SA	130 mm	27,99	1	TL AA-SA-ET

Pinças ergonómicas ESD de aço inoxidável, modelo SM116, com pontas ranhuradas para o posicionamento de dispositivos cilíndricos verticais



TL SM116-SA-ET

		€		
SM116	115 mm	40,53	1	TL SM116-SA-ET

Pinça ergonómica de aço inoxidável com segurança ESD Estilo 7A com pontas curvas e finas



TL 7A-SA-ET

		€		
7A	122 mm	40,03	1	TL 7A-SA-ET

Pinças ergonómicas seguras contra ESD em aço inoxidável Estilo 7 com pontas curvas e muito finas



TL 7-SA-ET

		€		
7-SA	122 mm	40,03	1	TL 7-SA-ET

PINÇAS ECONÓMICAS

Pinças - Uso industrial
Aço inoxidável, anti-magnético, anti-ácido.



TL 00-SA-SL

		€		
00	120 mm	19,11	5	TL 00-SA-SL

Aço inoxidável, anti-magnético, anti-ácido

Pinças - Uso industrial
Aço inoxidável, anti-magnético, anti-ácido.



TL 1-SA-SL

		€		
1	120 mm	18,36	5	TL 1-SA-SL

Aço inoxidável, anti-magnético, anti-ácido

Pinças - Uso industrial
Aço inoxidável, anti-magnético, anti-ácido.



TL 2A-SA-SL

		€		
2A	118 mm	18,76	5	TL 2A-SA-SL

Aço inoxidável, anti-magnético, anti-ácido

Pinças - Uso industrial
Aço inoxidável, anti-magnético, anti-ácido.



TL 2-SA-SL

		€		
2	120 mm	18,76	5	TL 2-SA-SL

Aço inoxidável, anti-magnético, anti-ácido

Pinças - Uso industrial
Aço inoxidável, anti-magnético, anti-ácido.



TL 3C-SA-SL

		€		
3C	110 mm	18,36	5	TL 3C-SA-SL

Aço inoxidável, anti-magnético, anti-ácido

Pinças - Uso industrial
Aço inoxidável, anti-magnético, anti-ácido.



TL 3-SA-SL

		€		
3	125 mm	18,36	5	TL 3-SA-SL

Aço inoxidável, anti-magnético, anti-ácido

Pinças - Uso industrial
Aço inoxidável, anti-magnético, anti-ácido.



TL 4-SA-SL

		€		
4	110 mm	20,40	5	TL 4-SA-SL

Aço inoxidável, anti-magnético, anti-ácido

Pinças - Uso industrial
Aço inoxidável, anti-magnético, anti-ácido.



TL 5A-SA-SL

		€		
5A	110 mm	22,26	5	TL 5A-SA-SL

Aço inoxidável, anti-magnético, anti-ácido

Pinças - Uso industrial
Aço inoxidável, anti-magnético, anti-ácido.



TL 5-SA-SL

		€		
5	110 mm	22,26	5	TL 5-SA-SL

Aço inoxidável, anti-magnético, anti-ácido

Pinça - uso industrial. Aço inoxidável, antimagnético, antiácido



TL AC-SA-SL

		€		
AC	110 mm	18,40	5	TL AC-SA-SL

Pinças - Uso industrial
Aço inoxidável, anti-magnético, anti-ácido.



TL SS-SA-SL

		€		
SS	140 mm	18,36	5	TL SS-SA-SL

Aço inoxidável, anti-magnético, anti-ácido

Pinças - Uso industrial
Aço inoxidável, anti-magnético, anti-ácido.



TL AA-SA-SL

		€		
AA	128 mm	11,21	5	TL AA-SA-SL

Aço inoxidável, anti-magnético, anti-ácido

Pinças - Uso industrial
Aço inoxidável, anti-magnético, anti-ácido.



TL MM-SA-SL

		€			
MM	125 mm	11,21	5	TL MM-SA-SL	

Aço inoxidável, anti-magnético, anti-ácido

Pinças - Uso industrial
Aço inoxidável, anti-magnético, anti-ácido.



TL 7A-SA-SL

		€			
7A	120 mm	24,07	5	TL 7A-SA-SL	

Aço inoxidável, anti-magnético, anti-ácido

Pinças - Uso industrial
Aço inoxidável, anti-magnético, anti-ácido.



TL 7-SA-SL

		€			
7	120 mm	23,87	5	TL 7-SA-SL	

Aço inoxidável, anti-magnético, anti-ácido

PINÇAS SMD

Pinça SMD



TL SM104-SA

		€			
SM104	120 mm	40,25	1	TL SM 104-SA	

Pinça SMD



TL SM105-SA

		€			
SM105	120 mm	40,25	1	TL SM 105-SA	

Pinças SMD de aço inoxidável estilo SMD 106 com pontas finas para posicionar pacotes SOT horizontais



TL SM106-SA

		€			
SM106	120 mm	23,71	1	TL SM106-SA	

Pinça SMD



TL SM108-SA

		€			
SM108	120 mm	40,25	1	TL SM 108-SA	

Pinça SMD



TL SM109-SA

		€			
SM109	120 mm	40,25	1	TL SM 109-SA	

Pinça SMD



TL SM110-SA

		€			
SM110	120 mm	40,25	1	TL SM 110-SA	

Pinça SMD



TL SM111-SA

		€			
SM111	115 mm	40,25	1	TL SM 111-SA	

Pinças SMD de aço inoxidável estilo SMD 116 com pontas ranhuradas para posicionar dispositivos cilíndricos verticais



TL SM116-SA

		€			
SM116	115 mm	23,71	1	TL SM116-SA	

Pinça SMD



TL SM107-SA

		€			
SM107	120 mm	40,25	1	TL SM 107-SA	

Pinça SMD



TL SM103-SA

		€		
SM103	115 mm	40,25	1	TL SM 103-SA

COMPONENTES PINÇAS DE POSICIONAMENTO

Pinça p/componentes. Pontas em ângulo de 90° para peças de Ø2.0mm com dentes serrilhados



TL 578-SA

		€		
578	120 mm	32,84	1	TL 578-SA

Pontas em ângulo de 90° para peças de Ø2.0mm com dentes serrilhados

Pinça Multi-uso, extra forte. Pontas duras e finas com pino de alinhamento, dentes e pontas serrilhados



TL 648-SA

		€		
648	155 mm	33,53	1	TL 648-SA

Pontas duras e finas com pino de alinhamento, dentes e pontas serrilhados

Pinça SMD



TL SM115-SA

		€		
SM115	115 mm	40,25	1	TL SM 115-SA

Pinça p/componentes. Pontas em ângulo de 90° para peças de Ø1.0mm com dentes serrilhados



TL 582-SA

		€		
582	115 mm	32,84	1	TL 582-SA

Pontas em ângulo de 90° para peças de Ø1.0mm com dentes serrilhados

Pinça Multi-uso. Pontas duras e dobradas, dentes e pontas serrilhados



TL 124-SA

		€		
124	150 mm	31,57	1	TL 124-SA

Pontas duras e dobradas, dentes e pontas serrilhados

Pinça SMD



TL SM117-SA

		€		
SM117	120 mm	40,25	1	TL SM 117-SA

PINÇA GERAL DE PROPÓSITO

Pinça Multi-uso, extra forte. Pontas duras e cegas, dentes e pontas serrilhados



TL 475-SA

		€		
475	136 mm	37,41	1	TL 475-SA

Pontas duras e cegas, dentes e pontas serrilhados

Pinça Multi-uso, extra forte. Pontas duras, finas e dobradas com pino de alinhamento, pontas serrilhadas e dobradas



TL 649-SA

		€		
649	154 mm	33,44	1	TL 649-SA

Pontas duras, finas e dobradas com pino de alinhamento, pontas serrilhadas e dobradas

ACESSÓRIOS E PEÇAS SOBRESSALENTES

Conjunto de 2 pontas de fibra de carbono e 3 parafusos com pontas rectas, grossas e fortes TL 00CFR-SA



TL 00ACF

		€		
00CFR	40 mm	7,90	1	TL 00ACF

Pontas de pinças de substituição Extra Finas



TL 2AACF

		€		
2A	40 mm	15,16	1	TL 2AACF

Conjunto de 2 pontas de fibra de carbono e 3 parafusos com pontas rectas e finas para TL 242CFR-SA



TL 242ACF

		€		
242CFR	40 mm	7,90	1	TL 242ACF

Pontas de pinças de substituição planas e grossas



TL 249ACF

		€		
249CFR	40 mm	15,16	1	TL 249 ACF

Conjunto de 2 pontas de carbono PEEK e 3 parafusos com pontas rectas, finas, pontiagudas e fortes para TL 259CPR-SA



TL 259ACP

		€		
259CPR	40 mm	106,79	1	TL 259ACP

Conjunto de 2 pontas PVDF e 3 parafusos com pontas rectas, finas, pontiagudas e fortes para TL 259SVR-SA



TL 259ASV

		€		
259ASV	40 mm	13,03	1	TL 259ASV

Pontas de pinças de substituição Extra Finas



TL 259ACF

		€		
259CFR	40 mm	15,16	1	TL 259 ACF

Conjunto de 2 pontas PVDF e 3 parafusos com pontas rectas, muito finas e afiadas para TL 5SVR-SA-TL 5XSVR-SA



TL 5ASV

		€		
5SVR	40 mm	106,79	1	TL 5ASV

Pontas de pinças de substituição



TL 5ACF

		€		
5CF	40 mm	15,16	1	TL 5ACF

Pontas de pinças de substituição finas e curvas



TL 7ACF

		€		
7CFR	40 mm	15,16	1	TL 7ACF

Conjunto de 2 pontas de carbono PEEK e 3 parafusos com pontas rectas, muito finas e afiadas para TL 5CPR-SA-TL 5XCPR-SA



TL 5ACP

		€		
5CPR	40 mm	106,79	1	TL 5ACP

Conjunto de 2 pontas PVDF e 3 parafusos com pontas curvas e muito finas para TL 7SVR-SA



TL 7ASV

		€		
7SVR	40 mm	106,79	1	TL 7ASV

Conjunto de 2 pontas de carbono PEEK e 3 parafusos com pontas curvas e muito finas para TL 7CPR-SA



TL 7ACP

		€		
7CPR	40 mm	106,79	1	TL 7ACP



1-100-04-1-0	7311518019006	10	5,50	22
1-100-04-1-2	7311518244125	5	6,91	22
1-100-04-2-0	7311518019013	10	4,93	22
1-100-04-2-2	7311518244132	5	7,05	22
1-100-04-3-0	7311518019020	10	5,13	22
1-100-06-1-0	7311518019037	10	5,13	22
1-100-06-1-2	7311518000233	5	8,73	22
1-100-06-2-0	7311518019044	10	5,48	22
1-100-06-2-2	7311518003593	5	8,81	22
1-100-06-3-0	7311518019051	10	5,68	22
1-100-06-3-2	7311518293581	5	8,80	22
1-100-08-1-0	7311518019068	10	6,64	22
1-100-08-1-2	7311518000264	5	9,55	22
1-100-08-2-0	7311518019075	10	7,05	22
1-100-08-2-2	7311518003609	5	10,01	22
1-100-08-3-0	7311518019082	10	7,16	22
1-100-08-3-2	7311518295585	5	11,13	22
1-100-10-1-0	7311518019099	10	8,67	22
1-100-10-1-2	7311518000295	5	12,33	22
1-100-10-2-0	7311518019105	10	9,07	22
1-100-10-2-2	7311518003616	5	12,72	22
1-100-10-3-0	7311518019112	10	9,21	22
1-100-10-3-2	7311518295592	5	12,07	22
1-100-12-1-0	7311518019129	5	11,84	22
1-100-12-1-2	7311518028053	5	15,21	22
1-100-12-2-0	7311518019136	5	12,11	22
1-100-12-2-2	7311518244118	5	15,48	22
1-100-12-3-0	7311518019143	5	12,25	22
1-100-12-3-2	7311518295608	5	14,23	22
1-100-14-1-0	7311518019150	5	16,93	22
1-100-14-2-0	7311518019167	5	17,73	22
1-102-06-2-0	7311518019198	10	7,72	22
1-102-06-3-0	7311518019204	10	8,13	22
1-102-08-1-0	7311518019211	10	9,21	22
1-102-08-2-0	7311518019228	10	9,55	22
1-102-08-3-0	7311518019235	10	9,67	22
1-104-10-2-0	7311518019242	10	14,89	22
1-104-10-3-0	7311518019259	10	15,42	22
1-104-12-2-0	7311518019266	5	19,91	22
1-104-12-3-0	7311518019273	5	21,39	22
1-104-14-3-0	7311518019297	5	28,96	22
1-106-08-1-0	7311518019303	10	10,90	22
1-106-08-1-2	7311518000301	5	14,31	22
1-106-10-1-0	7311518019310	10	15,17	22
1-106-10-1-2	7311518000325	5	18,32	22
1-106-12-1-0	7311518019327	5	19,37	22
1-106-12-1-2	7311518295615	5	22,11	22
1-110-04-1-0	7311518019334	10	4,69	22
1-110-04-2-0	7311518019341	10	4,93	22
1-110-04-3-0	7311518044046	10	5,13	22
1-110-06-1-0	7311518019358	10	5,13	22
1-110-06-1-2	7311518295622	5	8,73	23
1-110-06-2-0	7311518019365	10	5,48	22
1-110-06-2-2	7311518003623	5	8,81	23
1-110-06-3-0	7311518019372	10	5,68	22
1-110-06-3-2	7311518295639	5	8,71	23
1-110-08-1-0	7311518019389	10	6,64	22
1-110-08-1-2	7311518000332	5	9,55	23
1-110-08-2-0	7311518019396	10	7,05	22
1-110-08-2-2	7311518003630	5	10,01	23
1-110-08-3-0	7311518019402	10	7,16	22
1-110-08-3-2	7311518295646	5	10,09	23
1-110-10-1-0	7311518019419	10	8,67	22
1-110-10-1-2	7311518000349	5	12,33	23
1-110-10-2-0	7311518019426	10	9,07	22
1-110-10-2-2	7311518003647	5	12,72	23
1-110-10-3-0	7311518019433	10	9,21	22
1-110-10-3-2	7311518295653	5	11,57	23
1-110-12-1-0	7311518019440	5	11,84	22
1-110-12-1-2	7311518295660	5	14,05	23
1-110-12-2-0	7311518019457	5	12,11	22
1-110-12-2-2	7311518295677	5	16,38	23
1-110-12-3-0	7311518019464	5	12,25	22
1-110-12-3-2	7311518295684	5	14,42	23
1-110-14-1-0	7311518019488	5	16,93	22
1-111-04-1-0	7311518044053	10	5,13	23
1-111-04-2-0	7311518019518	10	5,41	23
1-111-04-3-0	7311518019525	10	5,60	23
1-111-06-1-0	7311518019549	10	5,60	23
1-111-06-2-0	7311518019556	10	6,42	23
1-111-06-2-2	7311518000363	5	9,90	23
1-111-06-3-0	7311518019563	10	6,64	23
1-111-08-1-0	7311518019570	10	7,84	23
1-111-08-2-0	7311518019587	10	8,88	23
1-115-11-3-1	7311518003791	10	10,45	23
1-143-04-1-0	7311518105983	10	4,25	23
1-143-06-1-0	7311518019631	10	4,62	23
1-143-06-1-2	7311518022341	5	8,53	23
1-143-08-1-0	7311518019662	10	5,96	23
1-143-08-1-2	7311518028077	5	9,82	23
1-143-10-1-0	7311518019693	10	7,84	23
1-143-10-1-2	7311518022358	5	11,71	23
1-143-12-1-0	7311518019723	5	10,70	23
1-143-12-1-2	7311518295691	5	14,75	23
1-160-04-1-0	7311518019785	10	5,58	25
1-160-04-1-2	7311518244057	5	7,88	25



1-160-04-2-0	7311518019792	10	5,83	25
1-160-04-2-2	7311518244095	5	8,24	25
1-160-04-3-0	7311518019808	10	5,96	25
1-160-06-1-0	7311518019815	10	5,38	25
1-160-06-1-2	7311518000370	5	8,67	25
1-160-06-2-0	7311518019822	10	5,79	25
1-160-06-2-2	7311518003685	5	8,73	25
1-160-06-3-0	7311518019839	10	6,01	25
1-160-06-3-2	7311518295707	5	9,13	25
1-160-08-1-0	7311518019846	10	6,45	25
1-160-08-1-2	7311518000394	5	9,76	25
1-160-08-2-0	7311518019853	10	6,76	25
1-160-08-2-2	7311518003692	5	10,17	25
1-160-08-3-0	7311518019860	10	6,91	25
1-160-08-3-2	7311518295714	5	11,67	25
1-160-10-1-0	7311518019877	10	9,14	25
1-160-10-1-2	7311518000400	5	12,06	25
1-160-10-2-0	7311518019884	10	9,60	25
1-160-10-2-2	7311518295721	5	12,87	25
1-160-10-3-0	7311518019891	10	9,76	25
1-160-10-3-2	7311518295738	5	14,21	25
1-160-12-1-0	7311518019907	5	13,13	25
1-160-12-1-2	7311518295745	5	17,37	25
1-160-12-2-0	7311518019914	5	13,67	25
1-160-12-2-2	7311518295752	5	17,02	25
1-160-12-3-0	7314150292059	5	16,10	25
1-160-12-3-2	7311518298005	5	17,17	25
1-170-04-1-0	7311518044060	10	5,40	24
1-170-04-2-0	7311518019945	10	5,43	24
1-170-04-2-2	7311518244088	5	8,73	24
1-170-04-3-0	7311518019952	10	5,79	24
1-170-06-1-0	7311518019969	10	6,07	24
1-170-06-1-2	7311518244071	5	8,97	24
1-170-06-2-0	7311518019976	10	6,46	24
1-170-06-2-2	7311518003715	5	9,44	24
1-170-06-3-0	7311518019983	10	6,64	24
1-170-06-3-2	7311518295769	5	10,72	24
1-170-08-1-0	7311518019990	10	8,00	24
1-170-08-1-2	7311518000417	5	11,30	24
1-170-08-2-0	7311518020002	10	8,47	24
1-170-08-2-2	7311518003722	5	11,71	24
1-170-08-3-0	7311518020019	10	8,67	24
1-170-08-3-2	7311518295783	5	13,92	24
1-170-10-1-0	7311518020026	10	11,30	24
1-170-10-1-2	7311518028107	5	14,57	24
1-170-10-2-0	7311518020033	10	11,78	24
1-170-10-2-2	7311518244064	5	14,60	24
1-170-10-3-0	7311518020040	10	12,06	24
1-170-10-3-2	7311518295806	5	17,76	24
1-170-12-1-0	7311518020057	5	14,60	24
1-170-12-2-0	7311518020064	5	15,83	24
1-210-04-1-0	7311518020071	10	8,06	24
1-210-04-1-2	7311518243944	5	10,01	24
1-210-04-2-0	7311518020088	10	8,13	24
1-210-04-2-2	7311518244040	5	10,01	24
1-210-04-3-0	7311518020095	10	8,24	24
1-210-06-1-0	7311518020101	10	8,24	24
1-210-06-1-2	7311518000424	5	10,44	24
1-210-06-2-0	7311518020118	10	8,47	24
1-210-06-2-2	7311518003654	5	10,63	24
1-210-06-3-0	7311518020125	10	8,60	24
1-210-06-3-2	7311518293574	5	11,30	24
1-210-08-1-0	7311518020132	10	10,17	24
1-210-08-1-2	7311518000455	5	11,98	24
1-210-08-2-0	7311518020149	10	10,36	24
1-210-08-2-2	7311518000479	5	12,87	24
1-210-08-3-0	7311518020156	10	10,56	24
1-210-08-3-2	7311518295837	5	11,67	24
1-210-10-1-0	7311518020163	10	12,38	24
1-210-10-1-2	7311518000493	5	16,13	24
1-210-10-2-0	7311518020170	10	12,78	24
1-210-10-2-2	7311518003661	5	16,93	24
1-210-10-3-0	7311518020187	10	13,06	24
1-210-10-3-2	7311518295844	5	14,21	24
1-210-12-1-0	7311518020194	5	18,42	24
1-210-12-1-2	7311518028121	5	21,71	24
1-210-12-2-0	7311518020200	5	18,82	24
1-210-12-2-2	7311518244149	5	21,95	24
1-210-12-3-0	7311518020217	5	19,08	24
1-210-12-3-2	7311518295851	5	23,50	24
1-210-14-1-0	7311518020224	5	25,44	24
1-230-04-1-0	7311518020248	10	4,82	24
1-230-04-1-2	7311518244163	5	6,65	24
1-230-04-2-0	7311518020255	10	5,08	24
1-230-04-2-2	7311518244156	5	6,96	24
1-230-04-3-0	7311518020262	10	5,21	24
1-230-06-1-0	7311518020279	10	5,41	24
1-230-06-1-2	7311518000509	5	7,88	24
1-230-06-2-0	7311518020286	10	5,68	24
1-230-06-2-2	7311518000523	5	8,05	24
1-230-06-3-0	7311518020293	10	5,79	24
1-230-06-3-2	7311518293567	5	7,73	24
1-230-08-1-0	7311518020309	10	6,42	24
1-230-08-1-2	7311518000547	5	8,88	24
1-230-08-2-0	7311518020316	10	6,82	24
1-230-08-2-2	7311518000554	5	9,21	24





1-230-08-3-0	7311518020323	10	7,12	24
1-230-08-3-2	7311518295882	5	8,92	24
1-230-10-1-0	7311518020330	10	7,84	24
1-230-10-1-2	7311518000578	5	11,25	24
1-230-10-2-0	7311518020347	10	8,73	24
1-230-10-2-2	7311518003678	5	11,78	24
1-230-10-3-0	7311518020354	10	9,35	24
1-230-10-3-2	7311518295899	5	11,52	24
1-230-12-1-0	7311518020361	5	10,90	24
1-230-12-1-2	7311518295912	5	13,90	24
1-230-12-2-0	7311518020378	5	11,52	24
1-230-12-2-2	7311518295929	5	13,90	24
1-230-12-3-0	7311518020385	5	11,71	24
1-230-12-3-2	7311518295905	5	13,36	24
1-320-08-2-0	7311518191276	10	17,73	23
1-320-08-2-2	7311518270865	5	21,45	23
1-320-10-2-0	7311518020477	10	19,63	23
1-320-10-2-2	7311518270872	5	23,41	23
1-320-12-2-0	7311518020484	5	21,64	23
1-473-06-2-2	7311518201098	5	28,47	25
1-473-08-2-2	7311518201104	5	32,87	25
1-473-10-2-2	7311518201111	5	38,72	25
1-476-04-3-2	7311518010928	1	49,10	25
1-477-08-2-2	7311518037994	5	58,08	25
1-477-10-2-2	7311518201074	5	69,77	26
1-478-08-1-2	7311518141127	5	52,63	26
1-478-10-1-2	7311518241995	5	62,64	26
1-479-08-1-2	7311518176747	5	61,85	26
1-479-08-2-2	7311518180607	5	62,90	26
10-21-51	7311518229344	5	15,49	633
10-24-23	7311518229368	5	16,64	633
10-24-51	7311518229351	5	16,63	633
10-30-23	7311518229382	5	18,81	633
10-30-51	7311518229375	5	20,24	633
1016	7314150218189	10	4,69	218
1019	8412814010199	10	4,63	218
1031-10	7314150025442	5	26,68	571
1031-12	7314150025459	5	27,37	571
1031-14	7314150025466	5	27,91	571
1031-16	7314150025473	5	28,45	571
1031-18	7314150025480	5	29,12	571
1031-20	7314150025497	5	29,81	571
1031-22	7314150025503	5	30,46	571
1031-25	7314150025510	5	31,28	571
1031-28	7314150025527	5	32,23	571
1031-30	7314150025534	5	32,88	571
1031-32	7314150025541	5	33,57	571
1031-4	7314150025411	5	24,80	571
1031-40	7314150025558	5	35,99	571
1031-6	7314150025428	5	25,35	571
1031-8	7314150025435	5	25,88	571
1067	8412814010670	10	3,49	218
1084	7311518277291	5	87,04	270
10RM-10	7314153014351	1	19,79	45
10RM-13	7314153014368	1	22,45	45
10RM-14	7314150221677	1	22,82	45
10RM-17	7314153014375	1	26,54	45
10RM-19	7314153014382	1	29,10	45
10RM-8	7314153014344	1	17,59	45
10RM/SH6	7314150222971	1	143,69	46
10RZ-1/2	7314150358786	1	23,46	45
10RZ-11/16	7314150358816	1	29,12	45
10RZ-3/4	7314150358823	1	31,50	45
10RZ-3/8	7314150358762	1	20,93	45
10RZ-5/16	7314150358748	1	19,24	45
10RZ-5/8	7314150358809	1	27,70	45
10RZ-7/16	7314150358779	1	21,84	45
10RZ-9/16	7314150358793	1	24,67	45
111A	7314150476183	5	167,22	653
111M-10	7314151828653	10	7,26	40
111M-100	7314150401499	1	715,85	40
111M-11	7314151828660	10	7,89	40
111M-12	7314151828677	10	8,33	40
111M-13	7314151828684	10	8,77	40
111M-14	7314151828691	10	9,13	40
111M-15	7314151828707	10	9,46	40
111M-16	7314151828714	10	10,00	40
111M-17	7314151828721	10	10,69	40
111M-18	7314151828738	10	11,27	40
111M-19	7314151828745	10	12,88	40
111M-20	7314151828752	10	13,03	40
111M-21	7314151828769	10	14,89	40
111M-22	7314151828776	5	15,02	40
111M-23	7314151828783	5	15,90	40
111M-24	7314151828790	5	16,63	40
111M-25	7314151828806	5	18,04	40
111M-26	7314151828813	5	21,41	40
111M-27	7314151828820	5	23,55	40
111M-28	7314151828837	5	25,16	40
111M-29	7314151828844	5	25,79	40
111M-30	7314151828851	5	28,69	40
111M-32	7314151828868	5	30,92	40
111M-33	7314150222223	5	33,26	40
111M-34	7314151828875	5	35,79	40
111M-36	7314150135516	1	50,58	40
111M-38	7314150222230	1	59,82	40



111M-41	7314150135523	1	64,22	40
111M-46	7314150135530	1	84,69	40
111M-5.5	7314151828608	10	6,39	40
111M-50	7314150135547	1	95,92	40
111M-55	7314150135554	1	167,26	40
111M-6	7314151828615	10	5,81	40
111M-60	7314150135561	1	221,89	40
111M-65	7314150135578	1	295,49	40
111M-7	7314151828622	10	5,87	40
111M-70	7314150135585	1	351,24	40
111M-75	7314150135592	1	442,67	40
111M-8	7314151828639	10	6,04	40
111M-80	7314150135608	1	510,69	40
111M-85	7314150352999	1	687,01	40
111M-9	7314151828646	10	7,21	40
111M-90	7314150401475	1	695,25	40
111M-95	7314150401482	1	697,31	40
111M/11T	7314151828899	1	107,88	42
111M/14T	7314151828905	1	199,01	42
111M/17T	7314151828912	1	172,23	42
111M/17TL	7314150197859	1	221,71	42
111M/24T	7314150197866	1	364,21	42
111M/26T	7314151828929	1	380,62	42
111M/S10	7314150212965	1	94,61	42
111M/SH12	7314153013347	1	120,02	41
111M/SH5	7314150325252	1	45,64	41
111M/SH8	7314150197873	1	84,26	41
111Z-1	7314151829063	3	18,90	41
111Z-1.1/16	7314151829070	5	24,51	41
111Z-1.1/2	7314150135752	1	55,17	41
111Z-1.1/4	7314151829094	5	32,05	41
111Z-1.1/8	7314151829087	5	26,19	41
111Z-1.11/16	7314150135615	1	86,12	41
111Z-1.13/16	7314150135639	1	85,94	41
111Z-1.3/4	7314150135622	1	92,40	41
111Z-1.3/8	7314150135738	1	52,51	41
111Z-1.5/16	7314151829100	5	37,30	41
111Z-1.5/8	7314150135769	1	66,68	41
111Z-1.7/16	7314150135745	1	52,51	41
111Z-1.7/8	7314150135646	1	98,28	41
111Z-1/2	7314151828981	5	9,18	41
111Z-1/4	7314151828943	5	6,07	41
111Z-11/16	7314151829018	5	11,10	41
111Z-13/16	7314151829032	5	15,45	41
111Z-15/16	7314151829056	3	17,50	41
111Z-2	7314150135653	1	99,62	41
111Z-2.1/2	7314150135721	1	300,18	41
111Z-2.1/4	7314150135691	1	175,25	41
111Z-2.1/8	7314150135677	1	175,25	41
111Z-2.3/4	7314150135783	1	319,29	41
111Z-2.3/8	7314150135707	1	242,21	41
111Z-2.5/8	7314150135776	1	300,18	41
111Z-2.7/8	7314150135790	1	387,53	41
111Z-3	7314150135806	1	387,53	41
111Z-3/4	7314151829025	5	13,29	41
111Z-3/8	7314151828967	5	7,62	41
111Z-5/16	7314151828950	5	6,27	41
111Z-5/8	7314151829001	5	10,49	41
111Z-7/16	7314151828974	5	8,30	41
111Z-7/8	7314151829049	5	15,71	41
111Z-9/16	7314151828998	5	9,67	41
111Z/11T	7314151829124	1	153,78	43
111Z/8T	7314151829117	1	95,86	42
1150-1/2H/P	7314150129263	1	59,27	545
1150D	7311518276614	1	72,09	545
1154	7314150249831	1	141,47	326
1154-DG	7314150249800	1	77,10	326
1154-MB	7314150249817	1	57,17	326
1157	7311518277031	60	13,82	606
1162N-1/2	7314151847241	1	23,36	538
1177-SCRIBE	7314150120550	5	6,53	543
1178-SCRIBE	7314150120567	5	7,31	543
1179-FLX	7311518276997	25	2,71	543
1179-SCRIBE	7314150120574	5	21,44	543
1179-TIPS	7314150120581	1	7,43	543
11M-10	7314151829155	5	12,00	43
11M-11	7314151829162	5	12,00	43
11M-12	7314151829179	5	13,73	43
11M-13	7314151829186	5	13,73	43
11M-14	7314151829193	5	16,57	43
11M-15	7314151829209	5	16,57	43
11M-16	7314151829216	5	18,18	43
11M-17	7314151829223	5	18,76	43
11M-18	7314151829230	5	18,89	43
11M-19	7314151829247	5	23,75	43
11M-21	7314151829254	5	23,75	43
11M-22	7314151829261	5	17,81	43
11M-24	7314151829278	5	30,42	43
11M-27	7314151829285	1	39,45	43
11M-30	7314151829292	1	47,73	43
11M-32	7314151829308	1	47,73	43
11M-36	7314151829315	1	61,36	43
11M-38	7314151829322	1	65,02	43
11M-8	7314151829131	5	11,42	43
11M-9	7314151829148	5	11,42	43
11Z-1	7314150355303	5	37,41	43

			€	
11Z-1/2	7314150355235	5	12,15	43
11Z-11/16	7314150355266	5	15,05	43
11Z-13/16	7314150355280	5	17,66	43
11Z-3/4	7314150355273	5	16,85	43
11Z-3/8	7314150355211	5	11,41	43
11Z-5/8	7314150355259	5	15,05	43
11Z-7/16	7314150355228	5	11,80	43
11Z-9/16	7314150355242	5	12,58	43
121A	7314150476206	5	167,22	653
1300Z-1-1.1/8	7314153000989	1	69,67	52
1300Z-1/2-9/16	7314151039998	1	29,18	52
1300Z-1/4-5/16	7314153000965	1	26,56	52
1300Z-15/16-1	7314153005656	1	53,43	52
1300Z-19/32-11/16	7314151040000	1	33,64	52
1300Z-25/32-13/16	7314153000972	1	49,52	52
1300Z-3/8-7/16	7314151039981	1	26,56	52
1300Z-5/8-3/4	7314151040017	1	35,83	52
1300Z-7/8-15/16	7314153005649	1	41,01	52
1320RM-10-11	7314153014511	1	33,39	47
1320RM-12-13	7314153014528	1	35,61	47
1320RM-14-15	7314153014535	1	39,41	47
1320RM-16-17	7314153014542	1	43,26	47
1320RM-17-19	7314150359196	1	44,58	47
1320RM-18-19	7314153014559	1	46,55	47
1320RM-22-24	7314150221646	1	49,05	47
1320RM-6-7	7314153014498	1	31,05	47
1320RM-8-9	7314153014504	1	31,48	47
1320RM/SH8	7314150222988	1	317,35	47
1320RZ-1/2-9/16	7314153014580	1	45,27	47
1320RZ-1/4-5/16	7314153014566	1	31,05	47
1320RZ-3/4-13/16	7314150359264	1	40,60	47
1320RZ-3/4-7/8	7314150359271	1	40,60	47
1320RZ-3/8-7/16	7314153014573	1	39,57	47
1320RZ-5/16-11/32	7314153015235	60	33,69	47
1320RZ-5/8-11/16	7314150359257	1	26,11	47
1320RZ-7/8-15/16	7314150359288	1	53,73	47
1320SRM-14-19	7314150190355	1	41,94	47
1320SRM/S29	7314150188673	1	130,09	47
1321RZ-1/2-9/16	7314150359349	1	28,59	47
1321RZ-3/4-7/8	7314150359363	1	46,80	47
1321RZ-3/8-7/16	7314150359332	1	25,37	47
1321RZ-5/8-11/16	7314150359356	1	33,10	47
133SGM-100	7314151828523	1	552,66	55
133SGM-105	7314151828530	1	617,31	55
133SGM-110	7314151828547	1	673,88	55
133SGM-115	7314151828554	1	788,62	55
133SGM-120	7314151828561	1	801,55	55
133SGM-27	7314151828363	1	28,92	55
133SGM-30	7314151828370	1	33,95	55
133SGM-32	7314151828387	1	36,01	55
133SGM-36	7314151828394	1	46,40	55
133SGM-41	7314151828400	1	56,88	55
133SGM-46	7314151828417	1	76,60	55
133SGM-50	7314151828424	1	87,27	55
133SGM-55	7314151828431	1	101,79	55
133SGM-60	7314151828448	1	113,12	55
133SGM-65	7314151828455	1	141,75	55
133SGM-70	7314151828462	1	182,61	55
133SGM-75	7314151828479	1	195,53	55
133SGM-80	7314151828486	1	255,35	55
133SGM-85	7314151828493	1	268,27	55
133SGM-90	7314151828509	1	342,57	55
133SGM-95	7314151828516	1	360,37	55
14-24-3810	7311518002879	5	21,28	634
140	7314150008797	1	54,84	266
141	7314150008827	1	61,68	266
1410	7314150106332	1	77,09	266
1410D	7314150452842	1	85,88	266
1418-4	7314150510863	1	11,63	370
1418-5	7314150510870	1	13,77	370
1418-6	7314150510887	1	15,47	370
1418-7.5	7314150510894	1	17,61	370
1418-8.5	7314150510900	1	20,50	370
1418S	7314151040604	1	173,79	369
1419-M12	7314150257423	1	36,06	369
1419-M16	7314150358045	1	45,78	369
1419-M5	7314150257409	1	28,56	369
1419-M8	7314150257416	1	31,96	369
1419-MD	7311518277352	1	11,98	342
1419/4	7314150125036	1	129,93	369
142	7314150008841	1	82,96	266
1420	7314150103744	1	103,72	266
1420-1.4	7314151696337	1	3,37	369
1420D	7314150452859	1	115,50	266
1421-2.1	7314151696412	1	3,98	369
1422-3.1	7314151696689	1	5,55	369
1423-4.8	7314151696764	1	6,82	369
1424-6.2	7314151696849	1	8,17	369
143	7314150008872	1	135,48	266
1430FT120	7314150342006	1	127,48	384
1435/5	7314151040734	1	28,31	369
1435/8	7314151040741	1	89,45	369
144	7314150008902	1	225,71	266
1446	7314150128631	15	7,15	584
1446-CS	7314150508266	15	7,50	584
1446-FLOAT	7314150438464	15	12,32	584

			€	
1446-FLOAT-B	7314150524310	12	6,49	585
1446-OV	7314150313679	15	11,84	585
1450D-ISO	7314151040970	1	91,34	372
1450D-WVV	7314151040987	1	91,34	372
1450D/2	7314151040963	1	174,57	372
1460M/1	7314151041090	1	2.544,27	371
1460M/2	7314151041106	1	4.340,42	371
1460Z/2	7314151041120	1	6.453,23	372
1467-250	7314150124268	1	61,59	263
1467-320-850	7314150178636	1	258,79	263
1467-520	7314150124275	1	199,94	263
1467-LJ	7314150209033	1	19,17	264
1467-SJ	7314150208982	1	15,56	264
1468-10M10	7314150243457	1	19,65	349
1468-10M4	7314150243419	1	19,65	349
1468-10M5	7314150243426	1	19,65	349
1468-10M6	7314150243433	1	19,65	349
1468-10M8	7314150243440	1	19,65	349
1468-6M3	7314150243372	1	5,02	349
1468-6M4	7314150243389	1	5,02	349
1468-6M5	7314150243396	1	5,02	349
1468-6M6	7314150243402	1	5,02	349
1468-M10	7314150243228	6	256,78	348
1468-M6	7314150243211	1	102,22	348
147	7314150008933	1	434,96	266
147-1	7314150367047	1	40,09	117
147-1.1/4	7314150367061	1	42,60	117
147-1.1/8	7314150367054	1	40,09	117
147-1/2	7314150366965	1	35,08	117
147-11/16	7314150366996	1	35,08	117
147-13/16	7314150366644	1	31,33	117
147-13/16	7314150367016	1	40,09	117
147-14	7314150366651	1	31,33	117
147-15	7314150366668	1	31,33	117
147-15/16	7314150367030	1	40,09	117
147-16	7314150366675	1	31,33	117
147-17	7314150366682	1	31,33	117
147-18	7314150366699	1	31,33	117
147-19	7314150366705	1	31,33	117
147-21	7314150366712	1	37,58	117
147-22	7314150366729	1	37,58	117
147-24	7314150366736	1	37,58	117
147-25	7314150366743	1	42,60	117
147-27	7314150366750	1	42,60	117
147-3/4	7314150367009	1	35,08	117
147-30	7314150366767	1	42,60	117
147-32	7314150366774	1	42,60	117
147-33	7314150366781	1	46,37	117
147-34	7314150366798	1	46,37	117
147-35	7314150366804	1	46,37	117
147-36	7314150366811	1	46,37	117
147-37	7314150366828	1	48,87	117
147-38	7314150366835	1	48,87	117
147-39	7314150366842	1	48,87	117
147-41	7314150366859	1	48,87	117
147-45	7314150366866	1	172,91	117
147-46	7314150366873	1	172,91	117
147-5/8	7314150366989	1	35,08	117
147-50	7314150366880	1	179,17	117
147-55	7314150366897	1	192,95	117
147-60	7314150366903	1	206,73	117
147-65	7314150537860	1	211,15	117
147-68	7314150366910	1	233,04	117
147-7/16	7314150366958	1	35,08	117
147-7/8	7314150367023	1	40,09	117
147-70	7314150366927	1	233,04	117
147-75	7314150366934	1	273,13	117
147-9/16	7314150366972	1	35,08	117
147-90	7314150366941	1	345,81	117
1470K-AC1	7314150226498	1	102,72	382
1470K-AC2	7314150226504	1	121,98	382
1470K-AC3	7314150226511	1	44,94	382
1470K-AC4	7314150226528	1	51,36	382
1470K-AC7	7314150271320	1	129,58	383
1470K-AC8	7314150328581	1	103,83	383
1470K-AC8GR	7314150328598	1	103,83	383
1470K-ACSIDE	7314150226535	1	83,46	383
1470K-ACTD	7314150297269	1	197,45	382
1470K-ACTSS	7314150297283	1	385,18	382
1470K-ACTW	7314150297276	1	239,17	382
1470K7LH	7314150360444	1	781,13	381
1470K7LHBLUE	7314150407491	1	781,13	381
1470K7LHGREY	7314150407767	1	781,13	381
1470K7LHRED	7314150407507	1	781,13	381
1470KC2	7314150226696	1	181,63	383
1470KC3A	7314150506354	1	198,04	383
1470KC5	7314150226665	1	605,37	383
1470KC5PC	7314150226672	1	605,37	383
1470KCTRAY	7314150226702	1	45,15	383
1470KXL-ACTD	7314150297290	1	252,99	382
1470KXL-ACTSS	7314150297313	1	462,21	382
1470KXL-ACTW	7314150297306	1	377,63	382
1470KXLC-TRAY	7314150285549	1	67,89	383
1471KXLL2BKTTSS	7314150365432	1	2.732,67	380
1472K-ACTD	7314150399345	1	247,88	380
1472K-ACTSS	7314150399338	1	330,50	380



1472K-ACTW



1472K-ACTW	7314150393152	1	305,72	380
1472K5	7314150349463	1	898,16	377
1472K5BLACK	7314150349500	1	898,16	377
1472K5BLUE	7314150349616	1	898,16	377
1472K5GREY	7314150403813	1	898,16	377
1472K5RED	7314150349562	1	898,16	377
1472K5WHITE	7314150403707	1	898,16	377
1472K6	7314150349470	1	935,84	377
1472K6BLACK	7314150349531	1	935,84	377
1472K6BLUE	7314150349623	1	935,84	377
1472K6GREY	7314150403820	1	935,84	377
1472K6RED	7314150349579	1	935,84	377
1472K6WHITE	7314150399888	1	935,84	377
1472K7	7314150349487	1	972,99	377
1472K7BLACK	7314150349548	1	972,99	377
1472K7BLUE	7314150349630	1	972,99	377
1472K7GREY	7314150403837	1	972,99	377
1472K7RED	7314150349586	1	972,99	377
1472K7WHITE	7314150403714	1	972,99	377
1472K8	7314150349494	1	1.010,16	376
1472K8BLACK	7314150349555	1	1.010,16	376
1472K8BLUE	7314150349647	1	1.010,16	376
1472K8GREY	7314150404018	1	1.010,16	376
1472K8RED	7314150349593	1	1.010,16	376
1472K8WHITE	7314150403721	1	1.010,16	376
1475K-ACSIDE	7314150419968	1	63,02	383
1475K6	7314150349654	1	1.019,99	381
1475K6BLACK	7314150349685	1	1.019,99	381
1475K6BLUE	7314150349760	1	1.019,99	381
1475K6RED	7314150349715	1	1.019,99	381
1475K7	7314150349661	1	1.055,04	381
1475K7BLACK	7314150349692	1	1.055,04	381
1475K7BLUE	7314150349814	1	1.055,04	381
1475K7RED	7314150349746	1	1.055,04	381
1475K8	7314150349678	1	1.096,50	381
1475K8BLACK	7314150349708	1	1.096,50	381
1475K8BLUE	7314150349821	1	1.096,50	381
1475K8RED	7314150349753	1	1.096,50	381
1475KXL-AC20BK	7314150353903	1	473,84	382
1475KXL12	7314150350223	1	1.652,81	380
1475KXL12BLACK	7314150350230	1	1.652,81	380
1475KXL12RED	7314150402731	1	1.652,81	380
1475KXL6	7314150349968	1	1.500,89	381
1475KXL6BLACK	7314150349999	1	1.500,89	381
1475KXL6BLUE	7314150350162	1	1.500,89	381
1475KXL6C	7314150350193	1	1.610,18	381
1475KXL6CBK-FF5	7314150437467	1	3.676,50	376
1475KXL6CBK-FF6	7314150437474	1	2.926,87	375
1475KXL6CBLACK	7314150350209	1	1.610,18	381
1475KXL6RED	7314150350124	1	1.500,89	381
1475KXL7	7314150349975	1	1.555,53	380
1475KXL7BLACK	7314150350070	1	1.555,53	380
1475KXL7BLUE	7314150350179	1	1.555,53	380
1475KXL7RED	7314150350148	1	1.555,53	380
1475KXL8	7314150349982	1	1.599,25	380
1475KXL8BLACK	7314150350094	1	1.599,25	380
1475KXL8BLUE	7314150350186	1	1.599,25	380
1475KXL8RED	7314150350155	1	1.599,25	380
1475KXXL-ACTSS	7314150459896	1	392,53	381
1475KXXL-ACTW	7314150465330	1	710,80	382
1475KXXL8CWTSS	7314150400157	1	4.662,48	380
1476KXXL7BK	7314150439935	1	2.864,43	380
1477K-AC10	731415035163	1	92,90	379
1477K-AC12	7314150369195	1	177,05	377
1477K-AC13	7314150369218	1	118,04	377
1477K-AC14	7314150369225	1	53,12	378
1477K-AC15	7314150369249	1	141,64	378
1477K-AC16	7314150369256	1	236,07	378
1477K-AC17	7314150369270	1	47,21	378
1477K-AC18	7314150369287	1	54,30	378
1477K-AC19	7314150369676	1	47,21	378
1477K-AC20	7314150369683	1	42,49	378
1477K-AC21	7314150370412	1	88,53	378
1477K-AC22	7314150369706	1	65,21	378
1477K-AC24	7314150370429	1	324,60	379
1477K-AC25	7314150370436	1	413,14	379
1477K-AC26	7314150414864	1	81,35	379
1477K-AC30	7314150469949	1	123,74	379
1477K-ACTD	7314150370474	1	201,20	379
1477K-ACTP	7314150383764	1	102,70	379
1477K-ACTSS	7314150370450	1	283,29	379
1477K-ACTW	7314150370467	1	247,88	379
1477K6	7314150350391	1	1.326,02	376
1477K6BLACK	7314150351091	1	1.326,02	376
1477K6GREY	7314150351138	1	1.326,02	376
1477K6RED	7314150403653	1	1.326,02	376
1477K6WHITE	7314150358137	1	1.326,02	376
1477K7	7314150350407	1	1.391,59	376
1477K7BLACK	7314150351107	1	1.391,59	376
1477K7GREY	7314150351145	1	1.391,59	376
1477K7RED	7314150403660	1	1.391,59	376
1477K7WHITE	7314150358144	1	1.391,59	376
1477K8	7314150350414	1	1.424,39	376
1477K8BLACK	7314150351114	1	1.424,39	376
1477K8GREY	7314150351183	1	1.424,39	376
1477K8RED	7314150403677	1	1.424,39	376



1477K8WHITE	7314150358151	1	1.424,39	376
1477K9	7314150350940	1	1.468,09	376
1477K9BLACK	7314150351121	1	1.468,09	376
1477K9GREY	7314150351190	1	1.468,09	376
1477K9RED	7314150403684	1	1.468,09	376
1477K9WHITE	7314150403691	1	1.468,09	376
148-1	7314150367801	1	42,60	118
148-1/2	7314150367726	1	35,08	118
148-11/16	7314150367757	1	35,08	118
148-13	7314150367559	1	32,57	118
148-13/16	7314150367771	1	42,60	118
148-14	7314150367566	1	32,57	118
148-15	7314150367573	1	32,57	118
148-15/16	7314150367795	1	42,60	118
148-16	7314150367580	1	32,57	118
148-17	7314150367597	1	32,57	118
148-18	7314150367603	1	32,57	118
148-19	7314150367610	1	32,57	118
148-21	7314150367627	1	37,58	118
148-22	7314150367634	1	37,58	118
148-24	7314150367641	1	37,58	118
148-27	7314150367658	1	37,58	118
148-28	7314150367665	1	42,60	118
148-3/4	7314150367764	1	35,08	118
148-30	7314150367672	1	42,60	118
148-32	7314150367689	1	42,60	118
148-34	7314150367696	1	46,37	118
148-36	7314150367702	1	46,37	118
148-41	7314150367719	1	46,37	118
148-5/8	7314150367740	1	35,08	118
148-7/8	7314150367788	1	42,60	118
148-9/16	7314150367733	1	35,08	118
1482K4	7314150415779	1	572,89	377
1482K4BKW	7314150426126	1	716,11	377
1482K4BLACK	7314150415786	1	572,89	377
1482K4BLUE	7314150415793	1	572,89	377
1482K4GREY	7314150415809	1	572,89	377
1482K4RED	7314150415816	1	572,89	377
1482K4W	7314150425174	1	716,11	377
1482K4WHITE	7314150415823	1	572,89	377
1482K5W	7314150431274	1	802,04	377
1483CART	7314150273256	1	209,80	458
1483K2RB	7314150230013	1	330,61	458
1483K3RB	7314150230037	1	401,93	458
1483KHD3RB	7314150230099	1	544,54	458
1483KHD3RB-FF1	7314150233564	1	2.765,44	456
1483KHD3RB-FF2	7314150233571	1	2.695,75	456
1483KHD3RB-FF3	7314150233588	1	2.639,30	457
1483KHD3RB-FF4	7314150233595	1	2.194,40	457
1483KHD3RB-FF5	7314150233601	1	2.637,69	457
1483KHD3RB-FF7	7314150336050	1	2.005,10	457
1483KHD4RB	7314150230105	1	641,78	458
1484THD3RB	7314150265435	1	483,90	458
1485K4	7314150349838	1	631,50	381
1485K4BLACK	7314150349920	1	631,50	381
1485K4BLUE	7314150349944	1	631,50	381
1485K4RED	7314150349937	1	631,50	381
1485KXL4	7314150350247	1	820,36	381
1485KXL4BLACK	7314150350346	1	820,36	381
1485KXL4BLUE	7314150350360	1	820,36	381
1485KXL4RED	7314150350353	1	820,36	381
1487K4	7314150351206	1	1.003,31	376
1487K4BKW	7314150426133	1	1.003,31	376
1487K4BLACK	7314150351213	1	1.003,31	376
1487K4GREY	7314150351237	1	1.003,31	376
1487K4W	7314150425181	1	1.025,47	376
1495CD-AC1	7314150296965	1	80,27	453
1495CD60	7314150296927	1	508,35	450
1495CD60TS1	7314150325627	1	1.961,83	448
1495CD60W	7314150303656	1	1.056,83	451
1495CS-AC1	7314150296910	1	120,40	453
1495CS15	7314150296934	1	688,95	450
1495CS15BL	7314150326860	1	688,95	450
1495CS15TS1	7314150325610	1	2.111,19	448
1495CS18	7314150296941	1	769,21	450
1495CS18BL	7314150326891	1	769,21	450
1495CS18BLHK	7314150407620	1	838,11	450
1495CS18HK	7314150407613	1	838,11	450
1495CS18TS1	7314150325603	1	2.227,89	448
1495FWB097TD	7314150296675	1	529,53	456
1495FWB120TD	7314150296682	1	590,85	456
1495FWB120TS	7314150296668	1	406,90	456
1495K6CBKWB15TS	7314150368990	1	1.525,04	455
1495K6CBKWB15TW	7314150369034	1	1.765,84	455
1495K6CBKWB18TS	7314150369591	1	1.591,93	454
1495K6CBKWB18TW	7314150369638	1	1.899,62	455
1495K6CBLWB15TS	7314150369119	1	1.525,04	455
1495K6CBLWB15TW	7314150369232	1	1.765,84	455
1495K6CBLWB18TS	7314150369744	1	1.591,93	454
1495K6CBLWB18TW	7314150369782	1	1.899,62	455
1495K6CRDWB15TS	7314150368600	1	1.525,04	455
1495K6CRDWB15TW	7314150368655	1	1.765,84	455
1495K6CRDWB18TS	7314150369478	1	1.591,93	454
1495K6CRDWB18TW	7314150369515	1	1.899,62	455
1495K6CWB15TS	7314150368440	1	1.525,04	455
1495K6CWB15TW	7314150368501	1	1.765,84	455

		€			
1495K6CWB18TS	7314150369355	1	1.591,93	454	
1495K6CWB18TW	7314150369393	1	1.899,62	455	
1495K7CBKWB15TS	7314150369003	1	1.618,69	455	
1495K7CBKWB15TW	7314150369041	1	1.859,48	455	
1495K7CBKWB18TS	7314150369607	1	1.685,58	454	
1495K7CBKWB18TW	7314150369645	1	1.993,26	455	
1495K7CBLWB15TS	7314150369164	1	1.618,69	455	
1495K7CBLWB15TW	7314150369263	1	1.859,48	455	
1495K7CBLWB18TS	7314150369751	1	1.685,58	454	
1495K7CBLWB18TW	7314150369799	1	1.993,26	455	
1495K7CRDWB15TS	7314150368624	1	1.618,69	455	
1495K7CRDWB15TW	7314150368662	1	1.859,48	455	
1495K7CRDWB18TS	7314150369485	1	1.685,58	454	
1495K7CRDWB18TW	7314150369522	1	1.993,26	455	
1495K7CWB15TS	7314150368464	1	1.618,69	455	
1495K7CWB15TW	7314150368518	1	1.859,48	455	
1495K7CWB18TS	7314150369362	1	1.685,57	454	
1495K7CWB18TW	7314150369409	1	1.993,26	455	
1495K8CBKWB15TS	7314150369010	1	1.665,51	455	
1495K8CBKWB15TW	7314150369058	1	1.906,30	455	
1495K8CBKWB18TS	7314150369614	1	1.732,40	454	
1495K8CBKWB18TW	7314150369652	1	2.040,08	455	
1495K8CBLWB15TS	7314150369188	1	1.665,51	455	
1495K8CBLWB15TW	7314150369294	1	1.906,30	455	
1495K8CBLWB18TS	7314150369768	1	1.732,40	454	
1495K8CBLWB18TW	7314150369805	1	2.040,08	455	
1495K8CRDWB15TS	7314150368631	1	1.665,51	455	
1495K8CRDWB15TW	7314150368693	1	1.906,30	455	
1495K8CRDWB18TS	7314150369492	1	1.732,40	454	
1495K8CRDWB18TW	7314150369539	1	2.040,08	455	
1495K8CWB15TS	7314150368471	1	1.665,51	455	
1495K8CWB15TW	7314150368525	1	1.665,51	455	
1495K8CWB18TS	7314150370061	1	1.732,40	454	
1495K8CWB18TW	7314150369416	1	2.040,08	455	
1495KWB15TS	7314150338115	1	929,74	455	
1495KWB15TW	7314150296613	1	1.130,40	455	
1495KWB18TS	7314150338122	1	782,58	455	
1495KWB18TW	7314150296620	1	1.331,07	455	
1495TP-AC1	7314150297030	1	86,95	453	
1495TP-AC10	7314150297207	1	15,39	453	
1495TP-AC11	7314150297214	1	6,43	453	
1495TP-AC12	7314150297221	1	8,30	453	
1495TP-AC13	7314150297238	1	9,70	453	
1495TP-AC2	7314150297122	1	12,04	453	
1495TP-AC3	7314150297139	1	16,38	454	
1495TP-AC4	7314150297146	1	15,05	454	
1495TP-AC5	7314150297153	1	7,35	454	
1495TP-AC6	7314150297160	1	7,63	454	
1495TP-AC7	7314150297177	1	6,03	454	
1495TP-AC8	7314150297184	1	6,95	454	
1495TP-AC9	7314150297191	1	16,72	454	
1495TP-ACHL20	7314150297047	1	9,09	454	
1495TP-ACHL40	7314150297054	1	9,09	454	
1495TP-ACHL65	7314150297061	1	9,90	454	
1495TP-ACHL90	7314150297078	1	10,57	454	
1495TP-ACHU20	7314150297085	1	9,37	454	
1495TP-ACHU40	7314150297092	1	9,70	454	
1495TP-ACHU65	7314150297108	1	10,57	454	
1495TP-ACHU90	7314150297115	1	10,83	454	
1495TP-AUTO-M1	7314150438266	1	1.174,42	451	
1495TP-AUTO-M2	7314150438273	1	2.062,39	451	
1495TP-AUTO-M3	7314150438280	1	1.145,77	451	
1495TP-AUTO-M4	7314150438297	1	1.455,13	452	
1495TP-AUTO-M5	7314150438303	1	893,70	452	
1495TP-AUTO-M6	7314150438310	1	1.203,06	452	
1495TP06	7314150296989	1	113,71	452	
1495TP06GR	7314150326914	1	113,71	452	
1495TP09	7314150438624	1	116,78	452	
1495TP09-RAIL	7314150465705	1	37,13	453	
1495TP12	7314150296996	1	167,22	452	
1495TP12GR	7314150326921	1	167,22	452	
1495TP15	7314150297009	1	200,66	452	
1495TP18	7314150297016	1	234,11	452	
1495TP18GR	7314150326945	1	234,11	452	
1495WB-AC1	7314150296576	1	127,09	456	
1495WB15-AC1	7314150296590	1	140,46	456	
1495WB15TS	7314150296514	1	702,33	456	
1495WB15TSBL	7314150326990	1	648,16	456	
1495WB15TSBT	7314150407651	1	663,06	455	
1495WB15TSRED	7314150327003	1	702,33	456	
1495WB15TW	7314150296538	1	1.130,41	456	
1495WB15TWGR	7314150327140	1	1.130,41	456	
1495WB18-AC1	7314150296606	1	167,22	456	
1495WB18TS	7314150296545	1	782,58	456	
1495WB18TSBK	7314150327010	1	782,58	456	
1495WB18TSBL	7314150327027	1	782,58	456	
1495WB18TSBLBT	7314150407644	1	941,72	455	
1495WB18TSBT	7314150407637	1	941,72	455	
1495WB18TSRED	7314150327034	1	782,58	456	
1495WB18TW	7314150296569	1	1.290,93	456	
1495WB18TWGR	7314150327164	1	1.290,93	456	
1496MB2	7314150273478	1	130,20	462	
1496MB3	7314150273485	1	155,02	462	
1496MB4	7314150273492	1	186,02	462	
1496MB5	7314150273508	1	302,36	462	
1497MBF350	7314150321391	1	57,90	461	

		€			
1497MBF550	7314150321407	1	69,78	461	
1497MBF750	7314150321414	1	78,50	461	
1497MBW	7314150330164	1	573,39	461	
14A-32	7314150368228	1	102,74	119	
14A-9	7314150368211	1	75,18	119	
14F-1/2	7314150366200	1	42,60	116	
14F-3/4	7314150366217	1	71,42	116	
14P-1/2	7314150366064	1	100,24	116	
14Q-1/2	7314150366026	1	110,26	116	
14R-1/2	7314150365920	1	70,17	115	
14R-3/4	7314150365937	1	112,76	115	
14T-1/2	7314150366125	1	90,21	116	
14T-3/4	7314150366132	1	162,88	116	
14W	7314150357031	1	42,60	119	
1519 D	7314150032747	3	121,97	237	
1519-9	7314150026074	1	60,79	237	
1520 D	7311518278922	5	43,84	233	
1520 G	7311518266516	5	38,87	233	
1520 G IP	7314150437740	5	38,77	233	
1535	7314150214808	1	9,16	545	
1537	7314150214822	1	14,37	545	
1544	7311518276560	1	17,03	545	
1546	7314150214792	1	10,09	545	
1547	7311518276577	20	13,88	545	
158-N	7311518277239	12	37,14	242	
158-NB	7311518277246	12	38,64	244	
1610	7314150404186	1	78,70	266	
1610-NUT	7314150409594	1	12,49	266	
1620	7314150404193	1	107,06	266	
1620-NUT	7314150409754	1	14,61	266	
166-6-16-2.5-12	7311518027979	12	4,26	26	
166-6-16-2.5-2	7311518209698	5	8,74	26	
167-1	7314150419067	1	113,71	120	
167-1.1/16	7314150419074	1	113,71	120	
167-1.1/4	7314150419104	1	113,71	120	
167-1.1/8	7314150419081	1	113,71	120	
167-1.3/16	7314150419098	1	113,71	120	
167-1/2	7314150418930	1	57,73	120	
167-10	7314150418657	1	52,51	120	
167-11	7314150418664	1	52,51	120	
167-11/16	7314150419364	1	56,19	120	
167-12	7314150418671	1	54,26	120	
167-13	7314150418688	1	54,26	120	
167-13/16	7314150419036	1	75,28	120	
167-14	7314150418695	1	54,26	120	
167-15	7314150418701	1	54,26	120	
167-15/16	7314150419050	1	94,08	120	
167-16	7314150418718	1	55,63	120	
167-17	7314150418725	1	55,63	120	
167-18	7314150418732	1	59,93	120	
167-19	7314150418749	1	65,12	120	
167-20	7314150418763	1	65,36	120	
167-21	7314150418770	1	70,75	120	
167-22	7314150418787	1	88,47	120	
167-23	7314150418794	1	88,47	120	
167-24	7314150418800	1	88,47	120	
167-25	7314150418817	1	106,91	120	
167-26	7314150418824	1	106,91	120	
167-27	7314150418831	1	106,91	120	
167-28	7314150418848	1	106,91	120	
167-3/4	7314150419029	1	65,98	120	
167-30	7314150418909	1	55,86	120	
167-30	7314150418855	1	106,91	120	
167-32	7314150418862	1	106,91	120	
167-36	7314150418886	1	132,55	120	
167-5/16	7314150418893	1	55,86	120	
167-5/8	7314150419012	1	59,15	120	
167-7	7314150418619	1	52,51	120	
167-7/16	7314150418916	1	57,73	120	
167-7/8	7314150419043	1	94,08	120	
167-8	7314150418626	1	52,51	120	
167-8-21-3.2-12	7311518021986	12	7,43	26	
167-9	7314150418640	1	52,51	120	
167-9/16	7314150419005	1	57,73	120	
168-1	7314150419562	1	119,42	121	
168-1.1/16	7314150419579	1	119,42	121	
168-1.3/16	7314150419586	1	140,10	121	
168-1/2	7314150419487	1	60,55	121	
168-10	7314150419272	1	55,11	120	
168-11	7314150419289	1	55,11	120	
168-11/16	7314150419517	1	56,19	121	
168-12	7314150419296	1	56,95	120	
168-13	7314150419302	1	56,95	121	
168-13/16	7314150419531	1	73,02	121	
168-14	7314150419319	1	56,95	121	
168-15	7314150419326	1	56,95	121	
168-15/16	7314150419555	1	98,77	121	
168-16	7314150419333	1	58,40	121	
168-17	7314150419340	1	58,40	121	
168-18	7314150419357	1	62,86	121	
168-19	7314150419371	1	65,12	121	



168-26	7314150419432	1	112,30	121
168-27	7314150419449	1	112,30	121
168-3/4	7314150419524	1	73,02	121
168-3/8	7314150419463	1	58,64	121
168-5/16	7314150419456	1	58,64	121
168-5/8	7314150419500	1	62,11	121
168-6-3.2-1P	7311518152338	12	1,75	26
168-6-3.2-3P	7311518152413	12	5,04	27
168-6-3.5-1P	7311518152345	12	1,75	26
168-6-3.5-3P	7311518152420	12	5,04	27
168-7	7314150419241	1	55,11	120
168-7/16	7314150419470	1	58,64	121
168-7/8	7314150419548	1	98,77	121
168-8	7314150419258	1	55,11	120
168-8-4.0-1P	7311518152352	12	1,75	26
168-8-4.0-3P	7311518152437	12	5,04	27
168-8-4.0-6	7311518217419	6	1,71	27
168-8-4.5-1P	7311518152369	12	1,75	26
168-8-4.5-3P	7311518152444	12	5,04	27
168-8-4.5-6	7311518217426	6	1,71	27
168-8-4.8-1P	7311518152376	12	1,75	26
168-8-4.8-3P	7311518152451	12	5,04	27
168-8-4.8-6	7311518217433	6	1,71	27
168-8-5.2-1P	7311518152383	12	1,75	26
168-8-5.2-3P	7311518152468	12	5,04	27
168-8-5.2-6	7311518217440	6	1,72	27
168-8-5.5-1P	7311518152390	12	1,75	26
168-8-5.5-3P	7311518152475	12	5,04	27
168-8-5.5-6	7311518217457	6	1,71	27
168-8-6.3-1P	7311518152406	12	2,01	26
168-8-6.3-3P	7311518152482	12	5,04	27
168-9	7314150419265	1	55,11	120
168-9/16	7314150419494	1	60,55	121
168-COMBI-4.0	7311518209667	10	15,02	27
168-COMBI-4.0-6922	7311518209612	10	29,11	27
168-COMBI-4.5	7314150272860	10	15,02	27
168-COMBI-4.8	7311518209674	10	15,02	27
168-COMBI-4.8-6920	7311518209643	10	29,90	27
168-COMBI-5.5	7311518209681	10	15,02	27
168-COMBI-5.5-6924	7311518209650	10	29,90	27
169-10	7314150419630	1	57,89	121
169-11	7314150419647	1	57,89	121
169-12	7314150419654	1	59,88	121
169-13	7314150419661	1	59,88	121
169-14	7314150419678	1	59,88	121
169-15	7314150419715	1	59,88	121
169-16	7314150419722	1	61,25	121
169-17	7314150419739	1	61,25	121
169-18	7314150419746	1	66,06	121
169-19	7314150419753	1	68,40	121
169-20	7314150419760	1	72,00	121
169-21	7314150419777	1	77,99	121
169-22	7314150419784	1	97,56	121
169-23	7314150419791	1	97,56	121
169-24	7314150419807	1	97,56	121
169-27	7314150419814	1	117,82	121
169-7	7314150419609	1	57,89	121
169-8	7314150419616	1	57,89	121
169-9	7314150419623	1	57,89	121
16F-1/2	7314150418565	1	79,54	119
16F-1/4	7314150418541	1	79,54	119
16F-3/8	7314150418558	1	79,54	119
16R-1/2	7314150418602	1	101,01	119
16R-1/4	7314150418589	1	101,01	119
16R-3/8	7314150418596	1	101,01	119
1931M-10	7314151049256	5	11,33	49
1931M-11	7314151049263	5	12,17	49
1931M-12	7314151049270	5	12,17	49
1931M-13	7314151049287	5	12,17	49
1931M-14	7314151049294	5	12,99	49
1931M-17	7314151049324	5	17,19	49
1931M-4	7314151049171	5	9,65	49
1931M-4.5	7314151049188	5	9,65	49
1931M-5	7314151049195	5	9,65	49
1931M-5.5	7314151049201	5	9,65	49
1931M-6	7314151049218	5	9,65	49
1931M-7	7314151049225	5	9,65	49
1931M-8	7314151049232	5	10,06	49
1931M-9	7314151049249	5	10,90	49
1931M/10T	7314151049409	1	108,60	50
1931Z-1/2	7314151049775	5	12,99	49
1931Z-1/4	7314151049713	5	10,06	49
1931Z-1/8	7314150371563	5	15,52	49
1931Z-11/32	7314151049744	5	11,75	49
1931Z-11/32-3/8	7314150371624	5	18,45	49
1931Z-13/64	7314151049683	5	10,06	49
1931Z-15/64-1/4	7314150371570	5	17,35	49
1931Z-3/16	7314151049676	5	10,06	49
1931Z-3/8	7314151049751	5	12,17	49
1931Z-5/16	7314151049737	5	11,33	49
1931Z-5/32	7314151049669	5	10,06	49
1931Z-5/8	7314151049799	5	15,92	49
1931Z-7/16	7314151049768	5	12,99	49
1931Z-7/32	7314151049690	5	10,06	49
1931Z-9/16	7314151049782	5	13,85	49
1931Z-9/32	7314151049720	5	10,48	49



1931Z-9/32-5/16	7314150371600	5	16,37	49
1931Z/12T	7314150107674	1	140,40	50
1933M/6T	7314151821654	1	58,57	50
1936M-10-11	7314151051402	25	8,16	58
1936M-10-13	7314151344146	25	8,91	58
1936M-12-13	7314151051419	25	8,91	58
1936M-13-17	7314151830144	20	10,37	58
1936M-14-15	7314151051426	20	9,41	58
1936M-14-17	7314151051129	15	10,21	58
1936M-16-17	7314151051433	15	10,21	58
1936M-17-19	7314151051136	10	12,18	58
1936M-18-19	7314151051440	10	12,18	58
1936M-19-22	7314151051150	8	13,42	58
1936M-20-22	7314151830151	8	13,55	58
1936M-21-23	7314151830168	8	15,52	58
1936M-22-24	7314151830175	5	16,41	58
1936M-24-26	7314151830182	5	17,26	58
1936M-24-27	7314151051181	5	17,26	58
1936M-25-28	7314151830199	5	19,02	58
1936M-30-32	7314151051501	1	22,35	58
1936M-30-34	7314151838577	4	34,37	58
1936M-36-41	7314151830205	4	34,63	58
1936M-46-50	7314151830212	2	68,96	58
1936M-6-7	7314151051389	50	6,01	58
1936M-8-10	7314151830137	30	8,16	58
1936M-8-9	7314151051396	5	6,96	58
1936M/12	7314151830250	1	185,35	58
1936M/7	7314151830243	1	105,29	58
1943M-11-13	7314151052829	1	27,99	53
1943M-13-15	7314151804732	1	29,82	53
1943M-13-17	7314151804749	1	31,48	53
1943M-14-17	7314151052843	1	32,09	53
1943M-15-17	7314151052850	1	32,41	53
1943M-19-22	7314151052867	1	34,34	53
1943Z-11/16-13/16	7314150355174	1	35,92	53
1943Z-5/16-3/8	7314150355136	1	30,52	53
1943Z-5/8-3/4	7314150355167	1	32,00	53
1943Z-7/16-1/2	7314150355143	1	30,52	53
1943Z-9/16-5/8	7314150355150	1	32,00	53
1945W12	7314150352289	6	56,41	316
1945W14	7314150352265	8	36,88	316
1945W38	7314150352272	6	44,47	316
1949M-10-11	7314151055394	1	23,21	54
1949M-10-12	7314151055400	1	24,09	54
1949M-12-13	7314151055417	1	24,81	54
1949M-12-14	7314151055424	1	26,03	54
1949M-14-15	7314151304546	1	26,03	54
1949M-14-17	7314151055448	1	26,03	54
1949M-17-19	7314151055455	1	35,57	54
1949M-19-22	7314151055462	1	35,57	54
1949M-22-24	7314151304553	1	40,71	54
1949M-24-27	7314151055479	1	51,46	54
1949M-30-32	7314151304577	1	63,70	54
1949M-8-9	7314151304539	1	23,21	54
1949Z-1-1.1/8	7314151055547	1	56,66	54
1949Z-1/2-9/16	7314151055509	1	28,08	54
1949Z-3/4-7/8	7314151055530	1	33,95	54
1949Z-3/8-7/16	7314151055486	1	25,01	54
1949Z-5/8-3/4	7314151055523	1	31,46	54
1950MZ-3/8	7314150130207	1	77,02	55
1952M-10	7314151057213	10	10,20	43
1952M-11	7314151057220	10	10,94	43
1952M-12	7314151057237	10	11,56	43
1952M-13	7314151057244	10	12,53	43
1952M-14	7314151057251	10	12,64	43
1952M-15	7314151057268	10	14,96	43
1952M-16	7314151057275	10	16,18	43
1952M-17	7314151057282	10	16,72	43
1952M-18	7314151057299	10	18,71	43
1952M-19	7314151057305	10	19,61	43
1952M-20	7314151057312	10	20,77	43
1952M-21	7314151057329	10	21,58	43
1952M-22	7314151057336	5	24,20	43
1952M-23	7314151057343	5	26,14	43
1952M-24	7314151057350	5	27,32	43
1952M-25	7314151057367	5	29,16	43
1952M-26	7314151057374	5	29,44	43
1952M-27	7314151057381	5	31,39	43
1952M-28	7314151057398	1	35,79	43
1952M-29	7314151325763	1	38,20	43
1952M-30	7314151057404	1	40,11	43
1952M-32	7314151057411	1	41,94	43
1952M-34	7314151838553	1	54,36	43
1952M-36	7314151057428	1	71,26	43
1952M-41	7314151057435	1	88,59	43
1952M-46	7314151840105	1	142,53	43
1952M-50	7314151840112	1	181,18	43
1952M-55	7314151840129	1	231,37	43
1952M-6	7314151057176	10	9,18	43
1952M-60	7314151840136	1	352,35	43
1952M-65	7314150135226	1	450,30	43
1952M-7	7314151057183	10	9,18	43
1952M-70	7314150135301	1	486,21	43
1952M-75	7314150135325	1	550,97	43
1952M-8	7314151057190	10	9,07	43
1952M-80	7314150135509	1	660,59	43

			€	
1952M-9	7314151057206	10	10,20	43
1952M/10	7314151057688	1	128,45	44
1952M/14T	7314151057695	1	286,77	44
1952M/17T	7314151057473	1	258,69	44
1952M/26T	7314151057701	1	557,38	44
1952M/7T	7314151806637	1	109,13	44
1952M/SH12	7314153013330	1	176,72	44
1952M/SH6	7314153013286	1	79,43	44
1952Z-1	7314151057602	1	30,20	43
1952Z-1.1/16	7314151057619	1	33,20	43
1952Z-1.1/2	7314151057756	1	94,54	43
1952Z-1.1/4	7314151057633	1	45,02	43
1952Z-1.1/8	7314151057626	1	39,20	43
1952Z-1.3/8	7314151057732	1	88,28	43
1952Z-1.5/16	7314151057718	1	48,61	43
1952Z-1.5/8	7314151057763	1	113,32	43
1952Z-1.7/16	7314151057749	1	93,60	43
1952Z-1/2	7314151057527	5	19,46	43
1952Z-1/4	7314151057480	5	9,68	43
1952Z-11/16	7314151057558	5	19,42	43
1952Z-11/32	7314150111046	5	10,45	43
1952Z-13/16	7314151057572	5	22,71	43
1952Z-15/16	7314151057596	5	29,03	43
1952Z-3/4	7314151057565	5	21,23	43
1952Z-3/8	7314151057503	5	10,98	43
1952Z-5/16	7314151057497	5	9,83	43
1952Z-5/8	7314151057541	5	16,48	43
1952Z-7/16	7314151057510	5	11,92	43
1952Z-7/8	7314151057589	5	27,25	43
1952Z-9/16	7314151057534	5	14,51	43
1952Z/11T	7314151057725	1	179,90	45
1976TORX-T10	7314150123438	5	7,71	228
1976TORX-T15	7314150123452	5	7,93	228
1976TORX-T20	7314150123469	5	8,02	228
1976TORX-T25	7314150123476	5	8,13	228
1976TORX-T27	7314150123490	5	9,01	228
1976TORX-T30	7314150123506	5	9,45	228
1976TORX-T40	7314150123513	5	10,09	228
1976TORX-T6	7314150122240	5	7,62	228
1976TORX-T7	7314150123384	5	7,62	228
1976TORX-T8	7314150123391	5	7,62	228
1976TORX-T9	7314150123414	5	7,39	228
1976TORX/5T	7314150126927	1	41,22	228
1986TORX-T10	7314150123537	5	8,74	228
1986TORX-T15	7314150123544	5	8,96	228
1986TORX-T20	7314150123551	5	9,08	228
1986TORX-T25	7314150123568	5	9,24	228
1986TORX-T27	7314150123575	5	9,31	228
1986TORX-T30	7314150123582	5	9,69	228
1986TORX-T40	7314150123599	5	10,34	228
1986TORX-T9	7314150122233	5	8,44	228
1986TORX/7T	7314150123735	1	68,80	228
1995LM-1.5	7314150122172	10	0,70	224
1995LM-10	7314150123254	10	4,86	224
1995LM-12	7314150123261	10	7,29	224
1995LM-14	7314150123278	10	9,00	224
1995LM-2	7314150122189	10	0,51	224
1995LM-2.5	7314150123162	10	0,61	224
1995LM-3	7314150123179	10	0,80	224
1995LM-4	7314150123186	10	0,92	224
1995LM-5	7314150123209	10	1,35	224
1995LM-6	7314150123216	10	2,02	224
1995LM-7	7314150123223	10	2,66	224
1995LM-8	7314150123230	10	3,46	224
1995LM-9	7314150123247	10	4,32	224
1995M-0.9	7314150216291	10	0,80	223
1995M-1.5	7314150122158	10	0,50	223
1995M-10	7314150122912	10	2,37	223
1995M-12	7314150122943	10	3,83	223
1995M-14	7314150122967	10	5,40	223
1995M-17	7314150122974	10	8,66	223
1995M-19	7314150122981	10	13,05	223
1995M-2	7314150122745	10	0,55	223
1995M-2.5	7314150122752	10	0,57	223
1995M-22	7314150122998	10	19,45	223
1995M-3	7314150122769	10	0,76	223
1995M-4	7314150122776	10	0,86	223
1995M-5	7314150122790	10	0,82	223
1995M-6	7314150122813	10	1,03	223
1995M-7	7314150122837	10	1,47	223
1995M-8	7314150122851	10	1,84	223
1995M-9	7314150122875	10	2,12	223
1995M/10T	7314150123643	1	16,71	223
1995M/11T	7314150123650	1	20,55	223
1995M/15T	7314150123667	1	70,42	223
1995M/6T	7314150123629	1	5,59	223
1995M/8T	7314150123636	1	10,34	223
1995TORX-T10	7314150123308	5	5,07	226
1995TORX-T15	7314150123322	5	5,17	226
1995TORX-T20	7314150123339	5	5,38	226
1995TORX-T25	7314150123346	5	5,40	226
1995TORX-T27	7314150123353	5	5,52	226
1995TORX-T30	7314150123360	5	5,61	226
1995TORX-T40	7314150123377	5	5,88	226
1995TORX-T45	7314150123407	5	6,13	226
1995TORX-T50	7314150123421	5	6,96	226

			€	
1995TORX-T55	7314150216963	5	9,89	226
1995TORX-T6	7314150122196	5	6,26	226
1995TORX-T60	7314150216970	5	12,00	226
1995TORX-T7	7314150123285	5	6,26	226
1995TORX-T8	7314150123292	5	6,26	226
1995TORX-T9	7314150122219	5	5,93	226
1995TORX/11T	7314150123742	1	67,32	226
1995TORX/13T	7314150123759	1	80,83	227
1995TORX/4T	7314150123674	1	24,64	226
1995TORX/7T	7314150123711	1	40,18	226
1995Z-1/16	7314150122165	10	0,54	223
1995Z-1/2	7314150123117	10	5,42	223
1995Z-1/4	7314150123070	10	1,19	223
1995Z-1/8	7314150123025	10	0,60	223
1995Z-3/16	7314150123056	10	0,84	223
1995Z-3/32	7314150123018	10	0,47	223
1995Z-3/4	7314150123155	10	16,52	223
1995Z-3/8	7314150123094	10	2,89	223
1995Z-5/16	7314150123087	10	2,00	223
1995Z-5/32	7314150123049	10	0,74	223
1995Z-5/64	7314150123001	10	0,44	223
1995Z-5/8	7314150123131	10	9,79	223
1995Z-7/16	7314150123100	10	4,43	223
1995Z-7/32	7314150123063	10	0,97	223
1995Z/10T	7314150215980	1	13,79	224
1995Z/12T	7314150215997	1	22,45	224
1996M-1.5	7314150122202	10	1,62	225
1996M-10	7314150122721	10	9,39	225
1996M-12	7314150122738	5	10,04	225
1996M-2	7314150122653	10	1,80	225
1996M-2.5	7314150122660	10	1,63	225
1996M-3	7314150122677	10	1,68	225
1996M-4	7314150122684	10	2,00	225
1996M-5	7314150122691	10	3,27	225
1996M-6	7314150122707	10	3,72	225
1996M-8	7314150122714	10	5,24	225
1996TORX-T10	7314150122783	5	8,88	227
1996TORX-T15	7314150122806	5	9,17	227
1996TORX-T20	7314150122820	5	9,31	227
1996TORX-T25	7314150122844	5	9,46	227
1996TORX-T27	7314150122868	5	9,52	227
1996TORX-T30	7314150122882	5	9,97	227
1996TORX-T40	7314150122899	5	10,63	227
1996TORX-T45	7314150122905	5	11,14	227
1996TORX-T50	7314150122929	5	12,62	227
1996TORX-T9	7314150122226	5	7,70	227
1996TORX/5T	7314150123698	1	46,89	227
1998M-1.5	7314150185719	10	0,60	222
1998M-10	7314150185801	10	2,94	222
1998M-12	7314150185818	5	4,32	222
1998M-14	7314150185825	1	5,84	222
1998M-17	7314150185832	1	9,24	222
1998M-19	7314150185849	1	13,86	222
1998M-2	7314150185726	10	0,62	222
1998M-2.5	7314150185733	10	0,66	222
1998M-22	7314150185856	1	20,55	222
1998M-3	7314150185740	10	0,86	222
1998M-4	7314150185757	10	0,77	222
1998M-5	7314150185764	10	1,07	222
1998M-6	7314150185863	10	1,31	222
1998M-7	7314150185771	10	1,84	222
1998M-8	7314150185788	10	2,11	222
1998M-9	7314150185795	5	2,82	222
1998M/10T	7314150186228	1	17,89	222
1998M/11T	7314150186235	1	23,18	222
1998M/15T	7314150186242	1	75,84	222
1998M/6T	7314150186204	1	7,29	222
1998M/8R	7314150186266	1	12,72	222
1998M/8T	7314150186211	1	11,72	222
1999M/7H	7314151801076	1	32,77	222
1999MV-10	7314150121496	3	19,97	502
1999MV-12	7314150121502	3	22,45	502
1999MV-3	7314150121427	5	15,40	502
1999MV-4	7314150121434	5	15,95	502
1999MV-5	7314150121441	5	15,79	502
1999MV-6	7314150121458	5	16,10	502
1999MV-7	7314150121465	5	16,86	502
1999MV-8	7314150121472	5	17,81	502
1999MV-9	7314150121489	5	18,42	502
1RM-10	7314153000576	1	25,75	45
1RM-11	7314153000583	1	27,33	45
1RM-12	7314153000590	1	29,35	45
1RM-13	7314153000606	1	30,40	45
1RM-14	7314153000613	1	31,72	45
1RM-15	7314153000620	1	32,61	45
1RM-16	7314153000637	1	35,55	45
1RM-17	7314153000644	1	35,86	45
1RM-18	7314153000651	1	38,80	45
1RM-19	7314153000668	1	39,13	45
1RM-21	7314150214495	1	41,79	45
1RM-22	73141530005915	1	42,15	45
1RM-24	73141530005922	1	45,54	45
1RM-27	7314153014177	1	53,16	45
1RM-30	7314153014184	1	64,30	45
1RM-32	7314153014191	1	69,96	45
1RM-6	7314153014146	1	22,55	45



1RM-7



1RM-7	7314153014153	1	22,55	45
1RM-8	7314153000552	1	23,82	45
1RM-9	7314153000569	1	24,12	45
1RM/S5	7314150225514	10	155,22	46
1RM/SH12	7314150219780	10	387,58	46
1RM/SH6	7314150219773	1	183,46	46
1RM/SH8	7314150223015	1	262,55	46
1RMA-10-1/4-BIT	7314153014634	1	7,63	48
1RMA-10-1/4-SQ	7314153014603	1	9,72	48
1RMA-13-10-BIT	7314150223008	1	12,03	48
1RMA-13-3/8-SQ	7314153014610	1	10,22	48
1RMA-13-5/16-BIT	7314153014641	1	8,37	48
1RMA-19-1/2-SQ	7314153014627	1	11,05	48
1RMA-19-1/4-SQ	7314150190638	1	10,81	48
1RMA/S4	7314153014658	1	38,30	48
1RMA/S8	7314153014665	1	139,75	46
1RZ-1/2	7314153014245	1	33,28	45
1RZ-1/4	7314150153725	1	25,90	45
1RZ-11/16	7314153014269	1	40,71	45
1RZ-11/32	7314150358915	1	22,55	45
1RZ-15/16	7314150358939	1	58,50	45
1RZ-3/4	7314153014276	1	44,22	45
1RZ-3/8	7314153014214	1	27,08	45
1RZ-5/16	7314153014207	1	26,17	45
1RZ-5/8	7314153014252	1	38,27	45
1RZ-7/16	7314153014221	1	29,88	45
1RZ-7/8	7314150358922	1	48,63	45
1RZ-9/16	7314153014238	1	34,58	45
1RZ/SH8	7314150223022	1	282,95	46
1Z-1	7314150375189	10	16,83	41
1Z-1/2	7314150375103	10	6,30	41
1Z-11/16	7314150375134	10	7,81	41
1Z-11/32	7314150375073	10	5,33	41
1Z-13/16	7314150375158	10	10,43	41
1Z-15/16	7314150375172	5	16,59	41
1Z-3/16	7314150375028	20	7,46	41
1Z-3/4	7314150375141	10	9,01	41
1Z-3/8	7314150375080	10	5,33	41
1Z-5/16	7314150375066	10	4,64	41
1Z-5/8	7314150375127	10	7,54	41
1Z-7/16	7314150375097	10	5,70	41
1Z-7/32	7314150375035	20	7,46	41
1Z-7/8	7314150375165	10	10,43	41
1Z-9/16	7314150375110	10	6,67	41
1Z-9/32	7314150375059	20	7,18	41
2-21-51	7315962500011	5	16,35	633
2-300-14-0-0	7311518044138	10	7,73	31
2-300-14-2-0	7311518044145	10	7,73	31
2-300-14-4-0	7311518108786	10	8,15	31
2-300-14-D-1P	7311518189105	10	53,89	34
2-300-16-0-0	7311518020491	10	8,39	31
2-300-16-1-0	7311518020507	10	8,39	31
2-300-16-2-0	7311518020514	10	8,39	31
2-300-16-4-0	7311518020521	10	8,90	31
2-300-16-D-1P	7311518189129	10	72,31	34
2-300-18-0-0	7311518190545	10	9,76	31
2-300-18-2-0	7311518190552	10	9,76	31
2-301-14-0-0	7311518190569	10	8,90	31
2-301-14-2-0	7311518108748	10	8,90	31
2-301-14-D-1P	7311518189136	1	53,89	34
2-301-16-0-0	7311518108755	10	9,76	31
2-301-16-1-0	7311518020538	10	9,76	31
2-301-16-2-0	7311518020545	10	9,76	31
2-302-14-0-0	7311518044152	10	8,90	32
2-302-14-2-0	7311518044169	10	8,90	32
2-302-14-4-0	7311518108793	10	9,28	32
2-302-14-D-1P	7311518189150	10	59,30	34
2-302-16-0-0	7311518108762	10	9,76	32
2-302-16-1-0	7311518020552	10	9,76	32
2-302-16-2-0	7311518020569	10	9,76	32
2-302-16-4-0	7311518108809	10	10,14	32
2-302-16-D-1P	7311518189167	10	79,30	34
2-302-18-0-0	7311518190613	10	11,18	32
2-302-18-2-0	7311518190620	10	11,18	32
2-303-14-2-0	7311518044176	10	8,90	32
2-303-14-D-1P	7311518189174	10	53,89	34
2-303-16-0-0	7311518108779	10	9,76	32
2-303-16-1-0	7311518020576	10	9,76	32
2-303-16-2-0	7311518020583	10	9,76	32
2-303-16-4-0	7311518108830	10	10,14	32
2-303-16-D-1P	7311518189198	1	72,31	34
2-303-18-0-0	7311518190644	10	11,18	32
2-303-18-2-0	7311518190668	10	11,18	32
2-304-14-0-0	7311518044183	10	10,14	32
2-304-14-2-0	7311518044190	10	10,14	32
2-304-14-4-0	7311518108878	10	10,93	32
2-304-14-D-1P	7311518189204	10	59,30	34
2-304-16-0-0	7311518020590	10	11,18	32
2-304-16-1-0	7311518020606	10	11,18	32
2-304-16-2-0	7311518020613	10	11,18	32
2-304-16-4-0	7311518020620	10	11,81	32
2-304-16-D-1P	7311518189211	10	79,30	34
2-304-18-0-0	7311518190712	10	12,92	32
2-304-18-2-0	7311518190736	10	12,92	32
2-305-16-1-0	7311518020637	10	11,18	32
2-305-16-2-0	7311518108908	10	11,18	32



2-306-14-D-1P	7311518189228	1	59,30	35
2-306-16-1-0	7311518020644	10	11,18	32
2-306-16-2-0	7311518108854	10	11,18	32
2-307-14-0-0	7311518044206	10	7,73	32
2-307-14-2-0	7311518044213	10	7,73	32
2-307-14-4-0	7311518108885	10	8,15	32
2-307-14-D-1P	7311518189235	10	53,89	35
2-307-16-0-0	7311518020651	10	8,39	32
2-307-16-1-0	7311518020668	10	8,39	32
2-307-16-2-0	7311518020675	10	8,39	32
2-307-16-4-0	7311518020682	10	8,90	32
2-307-16-D-1P	7311518189242	10	72,31	35
2-307-18-0-0	7311518190965	10	9,76	32
2-307-18-2-0	7311518190972	10	9,76	32
2-308-14-2-0	7311518044220	10	10,14	32
2-308-14-D-1P	7311518189259	1	59,30	35
2-308-16-0-0	7311518108861	10	11,18	32
2-308-16-1-0	7311518020699	10	11,18	32
2-308-16-2-0	7311518020705	10	11,18	32
2-309-16-2-0	7311518108946	10	9,76	32
2-309-16-4-0	7311518191054	10	10,14	32
2-313-16-0-0	7311518191177	10	11,18	32
2-470-14-0-0	7311518191191	10	47,92	33
2-470-14-2-0	7311518109080	10	46,75	33
2-470-14-4-0	7311518191207	10	51,03	33
2-470-16-1-0	7311518010942	10	49,21	33
2-470-16-2-0	7311518109097	10	50,75	33
2-471-16-1-0	7311518010959	5	83,52	33
2-472-14-0-0	7311518191214	5	91,20	34
2-472-14-2-0	7311518109103	5	91,20	34
2-472-16-0-0	7311518191238	5	98,42	34
2-472-16-1-0	7311518010966	5	98,42	34
2-472-16-2-0	7311518108922	5	98,42	34
2010	7314151584610	1	3.208,08	442
202A	7314150476220	5	167,22	652
204030150	8413345400855	12	15,58	550
204030160	8413345400862	12	16,62	550
204030180	8413345400879	12	17,51	550
204050130	8413345097970	6	26,52	550
204530140	8413345097918	12	18,58	551
204550130	8413345097956	6	28,58	551
2045A3000	8413345097932	12	20,25	551
2047-0-8-4	7314151060459	5	6,37	229
2047-1-5-5	7314151060473	5	7,77	229
2047-1-2-8	7314151060480	5	9,95	229
2047-1-6-10	7314151060497	1	13,66	229
2047-2-12	7314151060503	1	19,91	229
2047PR-1-2	7314151060558	5	8,00	229
2047PR-3-4	7314151060565	5	13,22	229
2047PZ-1-2	7314150216390	5	8,19	229
204B	7314150476244	5	167,22	653
2058-BR	7314151849290	1	10,24	84
2058/S26	7314151849276	1	37,76	168
2058/S26-2	7314151849283	1	37,77	168
2058/S26AF	7314150516308	1	24,22	168
208	7311518017545	5	16,53	556
209027040	8413345400947	12	16,20	550
209227060	8413345400961	12	15,73	551
209228100	8413345099233	12	16,62	551
209250100	8413345099585	6	28,16	551
210	7315965100379	10	31,80	556
2100PD-150	7314150205691	5	31,36	234
2101D-125	7314150106387	5	20,07	232
2101D-125IP	7314150106431	5	18,48	232
2101D-140	7314150106394	5	20,07	232
2101D-140IP	7314150106325	5	18,48	232
2101D-160	7314150106400	5	20,41	232
2101D-160IP	7314150106318	5	18,80	232
2101D-180	7314150106417	5	22,20	232
2101D-180IP	7314150106448	5	20,60	232
2101G-125	7314150106462	5	24,00	232
2101G-125IP	7314150106516	5	22,42	232
2101G-125IPD	7314150335039	5	22,42	232
2101G-140	7314150106479	5	24,42	232
2101G-140IP	7314150106288	5	22,83	232
2101G-140IPD	7314150335053	5	22,83	232
2101G-160	7314150106486	5	24,92	232
2101G-160IP	7314150106295	5	23,37	232
2101G-160IPD	7314150335060	5	23,37	232
2101G-180	7314150106493	5	26,66	232
2101G-180IP	7314150106523	5	25,04	232
2101G-180IPD	7314150335077	5	25,04	232
2101GC-125IP	7314150106547	5	22,78	232
2101GC-140IP	7314150106554	5	22,90	232
2101GC-160IP	7314150106561	5	23,85	232
2101GC-180IP	7314150106578	5	25,99	232
2101PG-160	7314150113972	5	53,99	232
2101S-140	7314150106592	3	26,11	498
2101S-160	7314150106608	3	28,14	498
2101S-180	7314150106615	3	31,47	498
2101S-200	7314150106622	3	38,80	499
211035180	8413345000147	5	8,02	551
211042210	8413345000154	5	10,49	551
212027180	8413345000178	5	6,20	551
212033250	8413345129435	8	6,72	551
212202500	8413345110266	10	20,97	552



212302900	8413345110280	10	15,60	552
212502150	8413345110303	10	12,58	552
212602150	8413345110327	10	14,75	552
212602800	8413345129404	1	19,33	552
212704350	8413345122184	6	41,66	551
212A	7314150420827	10	193,56	653
213026140	8413345000185	5	5,14	551
2145020D0	8413345097994	1	13,02	551
2145020L0	8413345098045	1	13,02	551
2145025C0	8413345098083	1	13,59	552
2145025D0	8413345098007	1	13,16	551
2145025L0	8413345098052	1	13,16	551
2145030D0	8413345098014	1	13,33	551
2145030L0	8413345098069	1	13,33	551
2145035D0	8413345098021	1	13,59	551
2145035L0	8413345098076	1	13,59	551
2145039C0	8413345098090	1	13,93	552
2145PD-150	7314150114009	5	50,54	236
215-150	7311518017576	1	7,02	558
215000030	8413345131971	12	4,52	549
215000040	8413345131988	12	4,69	549
215000050	8413345131995	12	4,87	549
215000060	8412243557944	12	5,00	549
215000070	8413345132008	12	5,39	549
215000080	8413345132015	12	5,70	549
215000090	8413345132022	12	6,14	549
215000100	8413345132039	12	6,89	549
215000120	8413345132046	12	8,45	549
215500300	7314150220120	12	7,42	549
215500400	8413345122627	12	8,07	549
215500500	8413345122641	12	8,28	549
215500600	8413345122665	12	8,44	549
215500700	8413345122689	12	8,64	549
215500800	8413345122702	12	9,04	549
215500900	8413345137478	12	9,23	549
215501000	8413345122726	12	9,63	549
216-150-R	7311518017583	1	7,02	558
216-300-R	7311518017798	1	10,34	558
216000300	8413345403658	12	3,84	549
216000400	8413345403665	12	3,95	549
216000500	8413345403672	12	4,15	549
216000600	8413345403689	12	4,26	549
216000700	8413345403696	12	4,59	549
216000800	8413345403702	12	4,82	549
216000900	8413345403719	12	5,09	549
216001000	8413345403726	12	5,84	549
216001200	8413345403740	12	6,84	549
216100040	8413345132053	12	8,35	549
216100060	8413345132091	12	9,79	549
216100080	8413345132060	12	11,00	549
216100100	8413345132077	12	11,64	549
216100120	8413345132084	12	12,58	549
216500300	8413345407274	12	7,32	549
216500500	8413345407281	12	7,75	549
216500750	8413345407298	12	9,79	549
216501000	8413345407304	12	11,00	549
2171G-140	7314150116232	5	18,87	234
2171G-160	7314150116133	5	19,47	234
2171G-180	7314150116140	5	21,49	234
2171V-160	7314150126798	2	41,49	499
2171V-180	7314150126804	2	44,49	499
2171V-200	7314150466009	2	48,05	499
218	7311518017521	10	4,14	557
218-BULK	7311518140946	150	2,88	557
219	7311518140953	120	5,40	557
219001000	8413345029865	5	6,58	549
219001200	8413345029872	5	7,28	549
219001400	8413345029889	5	8,14	549
219001600	8413345029896	5	8,86	549
219002000	8413345029902	5	11,63	549
2190PD-150	7314150114016	5	53,43	237
219201000	8413345029667	5	10,66	549
219201200	8413345029674	5	11,67	549
219201400	8413345029681	5	14,32	549
219201600	8413345029698	5	15,88	549
219202000	8413345029704	5	19,94	549
219302500	8413345129466	10	18,70	549
219303000	8413345129473	10	20,07	549
219303500	8413345129480	10	21,41	549
21HDD-140	7314150231256	5	22,93	233
21HDD-140IP	7314150231263	5	21,34	233
21HDD-160	7314150231270	5	23,53	233
21HDD-160IP	7314150231287	5	21,97	233
21HDD-180	7314150231294	5	25,73	233
21HDD-180IP	7314150231300	5	24,13	233
21HDD-200	7314150231317	5	28,17	233
21HDD-200IP	7314150231324	5	26,57	233
21HDG-140	7314150231331	5	26,99	232
21HDG-140A	7314150237654	5	28,63	233
21HDG-140IP	7314150231348	5	25,40	232
21HDG-160	7314150231355	5	27,70	232
21HDG-160A	7314150237661	5	29,76	233
21HDG-160IP	7314150231362	5	26,11	232
21HDG-180	7314150231379	5	30,36	232
21HDG-180A	7314150237678	5	32,61	233
21HDG-180IP	7314150231386	5	28,77	232



21HDG-200	7314150231409	5	32,29	232
21HDG-200A	7314150238439	5	34,77	233
21HDG-200IP	7314150231416	5	30,71	232
21HDG-140IP	7314150231423	5	26,58	233
21HDG-160IP	7314150231430	5	27,66	233
21HDG-180IP	7314150231447	5	30,04	233
21HDG-200IP	7314150231454	5	31,59	233
221 D	7314150037070	5	14,72	248
221201200	8413345029711	5	5,50	550
221202000	8413345029728	5	6,71	550
221203000	8413345029735	5	9,80	550
221301200	8413345029742	5	5,50	550
221302000	8413345029759	5	6,53	550
221303000	8413345029766	5	9,80	550
222 D	7314150037087	5	15,22	248
22209004B	8413345401333	1	19,27	348
2223 D-150	7314150033591	5	29,12	252
2223 G-150	7314150113651	5	28,61	251
2223 S-150	7314150032983	3	33,03	500
2223V-160	7314150134113	2	52,01	501
223 D	7314150037094	5	16,22	248
2233 D-160	7314150114023	5	33,36	238
2233 D-200	7314150114030	5	40,98	238
2233 D-240	7314150114047	5	46,23	238
2233D-160IP	7314150114054	5	32,68	238
2233D-200IP	7314150114061	5	40,29	238
2233D-240IP	7314150114078	5	45,55	238
2235-160	7314150179695	1	50,46	238
224 D	7314150037100	5	18,29	248
225 D	7314150037117	5	27,98	248
225-PLUS	7311518029708	5	31,08	556
2250V-170	7314150128730	2	109,12	499
2250V-230	7314150128747	2	127,15	499
227-22	7314150419845	1	201,54	120
227-24	7314150419852	1	207,53	120
227-27	7314150419869	1	213,62	120
227-30	7314150419876	1	222,35	120
227-32	7314150419883	1	226,60	120
227-34	7314150419890	1	250,13	120
227-36	7314150419906	1	256,50	120
227-41	7314150419913	1	278,00	120
227-46	7314150419920	1	333,50	120
228	7311518014995	80	11,49	557
228-15-5P	7311518031442	10	4,14	558
228-22	7314150420070	1	224,50	121
228-24	7314150420087	1	224,50	121
228-27	7314150420094	1	224,50	121
228-30	7314150420100	1	233,43	121
228-32	7314150420117	1	238,02	121
228-32-100P	7311518150990	1	28,68	558
228-32-10P	7311518010867	10	4,90	558
228-32-5P	7311518031459	10	4,14	558
228-34	7314150420124	1	255,96	121
228-36	7314150420131	1	269,40	121
228-41	7314150420148	1	291,83	121
228-46	7314150420155	1	350,20	121
228-BULK	7311518009069	5	10,46	557
228-SD	7311518277048	24	23,68	153
228-SET-SD	7314150217946	1	130,27	154
229-SD	7311518277055	24	32,46	154
22F-3/4	7314150419821	1	250,98	119
22R-3/4	7314150419838	1	256,52	119
23-15	7311518274665	10	2,73	634
23-21	7311518012274	10	4,83	634
23-24	7311518003852	10	5,16	634
23-30	7311518003869	10	5,78	634
23-32	7311518003876	10	6,00	634
23-36	7311518003883	10	6,38	634
230-SD	7311518280956	25	72,93	154
2303B0000	8413345091404	6	18,26	550
2303D0000	8413345091428	6	19,25	550
2304C0000	8413345091565	6	22,80	550
2308A0000	8413345091602	6	18,67	550
2308B0000	8413345091626	6	19,37	550
232-SD	7314150214839	1	124,05	154
233-300	7311518044015	5	18,87	565
233-300-A	7311518044039	5	25,86	565
233-400	7311518044022	5	27,51	565
2339 D	7314150032792	3	20,18	236
2339 DIP	7314150103508	5	19,51	236
2339-220	7314150442461	5	16,09	237
2339-220IP	7314150101061	5	15,50	237
2339-250IP	7314150101078	5	17,43	237
2339-280IP	7314150101948	5	19,83	237
2339-300IP	7314150123865	6	26,50	237
2339D-300	7314150411245	5	24,44	236
2339D-300IP	7314150411238	6	23,85	236
234-A1	7311518013653	1	20,52	565
234-A2	7311518013660	1	21,67	565
234-SD	7314150214846	25	138,79	154
234-W1	7311518013608	10	8,72	565
234-W2	7311518013615	10	10,86	565
234-W3	7311518013622	10	14,04	565
238	7311518011314	60	11,71	557
239	7311518010874	150	5,81	557
2420 G-125	7314150102525	5	26,36	244



2420G-125IP



2420G-125IP	7314150447091	5	21,34	244
2421 D-140IP	7314150101979	5	22,81	245
2421 D-160IP	7314150101986	5	25,14	245
2421 D-180IP	7314150101993	5	29,99	245
2421 G-140	7314150102532	5	27,86	244
2421 G-140IP	7314150102006	5	27,16	244
2421 G-160	7314150102549	5	30,62	244
2421 G-160 IP	7314150100576	5	29,90	244
2421 G-180	7314150102556	5	36,78	244
2421 G-180 IP	7314150100583	5	36,08	244
2421GC-140IP	7314150447107	5	22,78	244
2421GC-160IP	7314150447114	5	25,04	244
2421GC-180IP	7314150233229	5	25,39	244
2421S-140	7314150447121	3	32,60	500
2421S-160	7314150447138	3	32,60	500
2421S-180	7314150447145	3	43,32	500
2421V-160	7314150126774	2	38,70	500
2427 D-160	7314150032846	5	27,01	243
2427 D-200	7314150169030	5	29,20	243
2427 G-160	7314150100408	5	29,47	243
2427 G-160 IP	7314150100743	5	28,77	243
2427 G-200	7314150100415	5	33,70	243
2427 G-200 IP	7314150100750	5	33,03	243
2427 GC-160IP	7314150102051	5	24,56	243
2427 GC-200IP	7314150102075	5	28,14	243
2427 S-200	7314150033027	3	33,98	500
2427S-160	7314150447008	3	33,72	500
2427V-200	7314150126903	2	52,01	500
2430 D-140	7314150032853	5	23,96	241
2430 D-140 IP	7314150100774	5	23,30	241
2430 D-160	7314150032860	5	25,85	241
2430 D-160 IP	7314150100781	5	25,13	241
2430 D-200	7314150032884	5	28,02	241
2430 D-200 IP	7314150100804	5	27,33	241
2430 G-140	7314150102563	5	27,09	241
2430 G-140 IP	7314150102143	5	26,41	241
2430 G-160	7314150024070	5	28,61	241
2430 G-160 IP	7314150100811	5	27,91	241
2430 G-200	7314150100422	5	32,82	241
2430 G-200 IP	7314150100835	5	32,13	241
2430 GC-140 IP	7314150102150	5	22,58	241
2430 GC-160 IP	7314150102167	5	23,61	241
2430 GC-200 IP	7314150102174	5	27,18	241
2430 S-160	7314150206742	3	27,76	500
2430 S-200	7314150033010	3	30,43	500
2430S-140	7314150446995	3	27,11	500
2430V-160	7314150126880	2	46,13	500
2430V-200	7314150126897	2	46,45	500
2431G-125	7314150447015	5	25,58	241
2431G-125IP	7314150447053	5	25,10	241
2431G-140	7314150447022	5	26,11	241
2431G-140IP	7314150447060	5	25,55	241
2431G-160	7314150447039	5	26,58	241
2431G-160IP	7314150447077	5	25,99	241
2431G-180	7314150447046	5	27,55	241
2431G-180IP	7314150447084	5	26,82	241
244-20-U7/8-HP	7311518012519	10	24,44	563
244-22-U7/8-HP	7311518012526	10	25,42	563
2446	7314150128648	15	11,09	583
2446-BL	7314150508242	15	9,37	583
2446-EL	7314150270736	12	9,38	584
2446-EL-HELP	7314150394500	12	10,25	584
2446-ELL	7314150370153	12	9,38	584
2446-ELR	7314150370146	12	9,38	584
2446-LAP	7314150508228	15	8,34	583
2446-LINO	7314150270750	12	8,72	583
2446-OV	7314150313662	15	11,09	584
2446-SAFE	7314150453078	15	9,13	583
2448	7314150136049	12	29,91	572
2449	7314150194056	12	27,49	572
244P-20-U7-HP	7311518235499	4	27,49	565
244P-22-U7-HP	7311518235482	10	28,55	565
2460	7314151063467	1	52,85	251
2461 C19	7314151063498	1	73,95	249
2461 C40	7314151063504	1	85,06	249
2461 C8	7314151063481	1	71,36	249
2463 D19	7314151063511	1	75,85	249
2463 D40	7314151063528	1	87,19	249
2463 D8	7314151588878	1	62,29	249
2464 A10	7314151063535	1	77,10	250
2464 A19	7314151063542	1	83,87	250
2464 A3	7314151406516	1	77,10	250
2464 A40	7314151063559	1	92,02	250
2465D-200	7314150120826	1	58,81	251
2466 B10	7314151063573	1	78,60	250
2466 B19	7314151063580	1	85,90	250
2466 B3	7314151406868	1	78,60	250
2466 B40	7314151063597	1	96,73	250
247-24	7314150367078	1	191,71	117
247-27	7314150367085	1	191,71	117
247-30	7314150367092	1	194,22	117
247-32	7314150367108	1	194,22	117
247-34	7314150367115	1	194,22	117
247-36	7314150367122	1	199,22	117
247-41	7314150367139	1	199,22	117
247-46	7314150367146	1	202,97	117



247-50	7314150367153	1	207,98	117
247-55	7314150367160	1	214,26	117
247-60	7314150367177	1	218,01	117
2470 G-160	7314150116188	5	18,30	242
2470 G-200	7314150116195	5	20,33	242
2471 G-160	7314150116225	5	16,75	245
2477 G-200	7314150116201	5	22,66	244
2477G-160	7314150134977	5	17,88	244
248-24	7314150367818	1	195,46	118
248-27	7314150367825	1	195,46	118
248-30	7314150367832	1	200,47	118
248-32	7314150367849	1	200,47	118
248-34	7314150367856	1	200,47	118
248-36	7314150367863	1	204,23	118
248-41	7314150367870	1	214,26	118
248-46	7314150367887	1	209,25	118
248-50	7314150367894	1	209,25	118
248-55	7314150367900	1	255,59	118
248-60	7314150367917	1	255,59	118
2484-20	7314150233250	1	9,86	370
2484-30	7314150233267	1	12,68	370
2484-45	7314150233274	1	19,71	370
2484-60	7314150233281	1	23,94	370
2484/S4	7311518276553	10	49,30	370
2484T-20	7314150455102	1	13,20	370
2484T-30	7314150455119	1	18,86	370
2484T-45	7314150455126	1	25,76	370
2484T-60	7314150455133	1	30,45	370
2484T/S4	7314150455096	1	79,47	370
2485	7314150242382	1	9,31	348
2487	7311518276058	12	17,36	536
2488	7311518276072	12	19,19	550
2489	7311518276065	12	23,59	550
24A-14	7314150368235	1	111,51	119
24A-27	7314150368242	1	176,67	119
24F-1	7314150366231	1	269,38	116
24F-3/4	7314150366224	1	230,54	116
24R-1	7314150365951	1	300,70	115
24R-3/4	7314150365944	1	181,68	115
24T-1	7314150366156	1	363,36	116
24T-3/4	7314150366149	1	275,64	116
24W	7314150368266	1	68,92	119
2500-16-XT-HP	7311518160159	4	44,19	563
2500-19-XT-HP	7311518160722	4	45,55	563
2500-22-XT-HP	7311518140922	4	46,88	563
2500-24-XT-HP	7311518181338	4	48,72	563
250400010	7314150314430	1	40,88	552
250400020	7314150393008	1	72,11	552
250400030	7314150393015	1	135,47	552
250501800	8413345128964	50	65,87	552
250502450	8413345128957	1	73,38	553
2509	7314151064280	50	77,31	371
2520	7314150023752	1	175,48	238
2521 G-140	7314150100293	5	27,65	246
2521 G-160 IP	7314150100620	5	28,59	246
2521D-140IP	7314150447176	5	19,98	246
2521D-160IP	7314150447183	5	23,54	246
2521G-140IP	7314150447169	5	28,02	246
2521G-160	7314150447152	5	30,47	246
2521S-140	7314150447190	3	32,34	500
2521S-160	7314150447206	3	34,03	500
2521V-160	7314150126781	2	39,32	500
2530	7314150326761	1	6,65	371
2530-40	7314151317294	5	46,82	536
2535F0	7314150402236	1	17,87	371
2535F1	7314151064495	1	39,39	371
2535F2	7314150233854	1	35,69	371
2535F3	7314150180233	1	64,65	371
2535L	7314150125357	12	27,29	371
255-17/34	7314150272372	2	56,84	561
255-34	7314150272365	2	64,84	561
2555	7311518276041	1	8,19	308
256-26	7311518000080	4	69,39	561
2600-16-XT11-HP	7311518239527	4	56,58	562
2600-19-XT-HP	7311518160760	4	58,75	563
2600-22-XT-HP	7311518160777	4	60,55	563
2620-80	7311518200947	1	283,66	238
2628 D-160	7314150123193	5	20,81	240
2628 D-180	7314150042661	5	23,80	240
2628 D-200	7314150123315	5	25,04	240
2628 G-160	7314150042999	5	24,76	239
2628 G-160IP	7314150055357	5	24,06	239
2628 G-180	7314150042678	5	27,17	239
2628 G-180IP	7314150044030	5	26,50	239
2628 G-200	7314150103539	5	28,98	239
2628 GC-160IP	7314150101863	5	19,20	239
2628 GC-180IP	7314150101870	5	20,74	239
2628 GC-200IP	7314150101887	5	22,81	239
2628 S-160	7314150206735	3	29,81	499
2628 S-180	7314150044054	3	33,03	499
2628 S-200	7314150043002	3	36,12	499
2628G-200IP	7314150101085	5	28,30	239
2629G-160	7314150446933	5	24,76	240
2629G-160IP	7314150446964	5	24,06	240
2629G-180	7314150446940	5	27,09	240
2629G-180IP	7314150446971	5	26,50	240

			€	
2629G-200	7314150446957	5	28,98	240
2629G-200IP	7314150446988	5	28,30	240
2630DC-160IP	7314150446896	5	17,89	240
2630DC-180IP	7314150446902	5	19,08	240
2630DC-200IP	7314150446919	5	21,93	240
2630GC-160IP	7314150180165	5	19,79	240
2630GC-180IP	7314150180172	5	19,94	240
2630GC-200IP	7314150180189	5	22,81	240
2630SC-180	7314150446926	3	25,27	499
2632	7314151065706	1	23,03	370
2633/S4	7311518276942	12	25,87	535
2633HD/S6	7314150205783	1	132,85	315
2633HD1	7314150230464	1	43,12	315
2633HD2	7314150230471	1	19,07	315
2633HD3	7314150230488	1	16,54	315
2633HD4	7314150230495	1	12,77	315
2633HD5	7314150230501	1	12,04	315
2633HD6	7314150230518	1	6,95	315
2633L/S4	7311518276959	12	26,36	535
2635	7311518276348	1	60,64	609
2640D-160	7314150123766	10	19,22	240
2640D-180	7314150123773	5	21,78	240
2640D-200	7314150123797	5	24,47	240
2646	7314151304638	1	81,78	235
2646 A	7314151304645	1	93,07	235
2646 AK	7314151396619	1	89,31	235
2646 K	7314151495862	1	92,61	235
2646 M	7314151487928	1	90,63	235
2646 MF	7314151573683	1	70,59	245
2646 MS	7314151573768	1	78,26	246
2646 R	7314151304706	1	76,82	235
2646 RA	7314151834838	1	90,77	235
2646 RK	7314151496678	1	116,15	235
2648	7314151304713	1	77,28	235
2648 A	7314151304720	1	110,33	235
2649	7314150058013	1	87,60	235
2650	7314151065829	1	72,70	248
2650 B	7314151065843	1	6,47	248
2656	7314151304737	1	84,98	237
2656 R	7314151473976	1	81,35	244
2656 S	7314150058044	1	65,15	242
2666	7314150058006	1	81,78	235
2666 FK	7314151066079	1	96,00	235
2674 NB	7314151066321	1	82,39	234
2674 NVDE	7314151498535	1	86,16	499
2676 B	7314151066390	1	85,24	235
2678 B	7314151066468	1	95,22	235
2678 G-160	7314150116157	5	16,08	241
2678 G-180	7314150116164	5	17,10	241
2678 G-200	7314150116171	5	18,48	241
2678V-160	7314150126835	2	41,78	499
2678V-180	7314150126842	2	45,55	499
2678V-200	7314150126859	2	48,99	499
268	7311518017538	5	13,18	557
2681	7311518276706	12	40,48	263
2681-1	7314150116980	1	3,46	264
2688D-250	7314150123520	3	41,56	240
2690	7314150411108	10	58,30	263
26S-1216	7314151830236	8	26,48	59
26S-16	7314150345588	5	7,55	59
26S-610	7314151830229	10	11,34	59
2700-22-XT7-HP	7311518191672	4	61,71	565
2700-24-XT7-HP	7311518191665	4	62,60	565
2704A	7314151066963	1	35,54	579
2705R	7314151821470	1	30,73	579
2720	7314150179701	1	243,06	238
2720-SH	7314150179718	1	185,86	238
2744	7314151809096	6	21,88	579
277-30	7314150367184	1	214,26	117
277-32	7314150367191	1	214,26	117
277-34	7314150367207	1	214,26	117
277-36	7314150367214	1	219,26	117
277-41	7314150367221	1	240,56	117
277-46	7314150367238	1	245,57	117
277-50	7314150367245	1	251,85	117
277-55	7314150367252	1	259,35	117
277-60	7314150367269	1	264,37	117
278-30	7314150367924	1	243,06	118
278-32	7314150367931	1	243,06	118
278-34	7314150367948	1	243,06	118
278-36	7314150367955	1	246,82	118
278-41	7314150367962	1	259,35	118
278-46	7314150367979	1	253,09	118
278-50	7314150367986	1	253,09	118
278-55	7314150367993	1	255,59	118
278-60	7314150368006	1	255,59	118
2784-2.5	7314150215607	1	35,78	214
2784-3.5	7314150215614	1	35,78	214
2784-4.5	7314150215621	1	35,78	214
2787 F	7314151474270	1	120,36	236
2787 G	7314150058020	1	131,42	236
27A-24	7314150368259	1	209,25	119
27F-1	7314150366248	1	319,51	116
27M-10-11	7314150180523	10	14,24	58
27M-12-13	7314150180547	10	16,82	58
27M-13-17	7314150180790	10	22,41	58

			€	
27M-14-15	7314150180554	10	18,80	58
27M-16-17	7314150180561	10	21,81	58
27M-16-18	7314150180806	10	23,19	58
27M-18-19	7314150180578	10	26,05	58
27M-20-22	7314150180585	10	29,72	58
27M-21-23	7314150180592	5	33,05	58
27M-21-24	7314150180813	5	34,52	58
27M-24-26	7314150180608	5	35,30	58
27M-24-27	7314150180820	5	35,92	58
27M-25-28	7314150180622	5	40,60	58
27M-27-29	7314150180639	5	46,37	58
27M-30-32	7314150180646	5	51,96	58
27M-6-7	7314150180509	10	13,27	58
27M-8-9	7314150180516	10	13,41	58
27M/10	7314150180677	1	222,42	59
27M/12	7314150180684	1	315,00	59
27M/12T	7314150180783	1	321,27	58
27M/6	7314150180653	1	98,35	58
27M/8	7314150180660	1	154,09	59
27M/8T	7314150180776	1	158,28	58
27R-1	7314150365968	1	344,56	115
27T-1	7314150366163	1	400,94	116
28-29/S4	7314150179688	1	107,34	251
2800 N	7314151318338	1	69,98	239
2800-140	7314150121632	3	19,69	249
2800-150	7314150034567	3	19,69	249
2800-180	7314150034581	3	22,48	249
2800-225	7314150034604	3	28,30	249
2800-300	7314150122622	1	38,80	249
2801 N	7314151318352	1	86,23	239
2804	7314151692698	1	436,26	238
2805-280	7314151826123	1	510,21	238
2820EF1	7314150122042	12	9,58	585
2820EF2	7314150122059	8	12,32	586
2820EF3	7314150122066	1	15,95	586
2820EF4	7314150122073	1	19,93	586
2820EK	7314150122035	6	7,68	585
2820EK-01	7314150270743	12	6,02	585
2820VBC	7314150121915	1	227,32	499
2820VDE	7314151605476	10	24,33	503
2820VFP	7314150121922	1	122,19	503
2820VG05	7314150121953	1	68,52	503
2820VG10	7314150121960	1	82,41	503
2820VGCOT	7314150121977	1	4,89	503
2820VHELP	7314150121908	1	59,99	503
2820VM	7314150121946	1	227,90	503
2820VP	7314150121885	2	30,08	502
2820VPC	7314150121892	2	32,63	503
2820VTEE	7314150121939	1	32,29	503
2855	7314151825805	1	154,37	264
2855 D	7314151822569	1	195,42	264
2856-10	7314150437214	1	314,51	264
2856-8	7314150437207	1	314,51	264
2890-125	7314150122639	3	17,07	249
2890-140	7314150034550	3	20,00	249
2890-180	7314150034574	3	23,20	249
2890-210	7314150034598	3	29,20	249
2890-300	7314150122646	1	43,62	249
28M-10	7314151834678	5	13,21	56
28M-11	7314151834685	5	13,80	56
28M-12	7314151834692	5	14,63	56
28M-13	7314151834708	5	15,71	56
28M-14	7314151834715	5	18,00	56
28M-15	7314151834722	5	19,07	56
28M-16	7314151834739	5	20,11	56
28M-17	7314151834746	5	20,93	56
28M-18	7314151834753	3	25,25	56
28M-19	7314151834760	3	26,65	56
28M-20	7314150122561	3	28,56	56
28M-21	7314151834777	3	31,05	56
28M-22	7314151834784	3	36,06	56
28M-23	7314150122578	3	37,55	56
28M-24	7314151834791	3	39,80	56
28M-25	7314150122585	3	45,42	56
28M-26	7314150122592	3	49,33	56
28M-27	7314151834807	3	53,87	56
28M-28	7314150122608	1	62,03	56
28M-29	7314150122615	1	70,73	56
28M-30	7314151834814	1	80,27	56
28M-32	7314151834821	1	95,67	56
28M-6	7314151834630	5	14,75	56
28M-7	7314151834647	5	15,36	56
28M-8	7314151834654	5	12,64	56
28M-9	7314151834661	5	12,52	56
28M/11	7314151838126	1	200,05	57
28M/12	7314151838133	1	209,34	57
28M/15	7314151838140	1	316,26	57
28M/8	7314151838119	1	145,69	57
28MV-10	7314150121298	2	36,85	501
28MV-11	7314150121304	2	37,32	501
28MV-12	7314150121311	2	37,65	501
28MV-13	7314150121328	2	37,97	501
28MV-14	7314150121335	2	42,54	501
28MV-15	7314150121342	2	43,03	501
28MV-16	7314150121359	2	44,18	501
28MV-17	7314150121366	2	44,81	501



28MV-18



28MV-18	7314150121373	2	46,07	501
28MV-19	7314150121380	2	46,07	501
28MV-20	7314150121397	2	45,92	501
28MV-21	7314150121403	2	46,24	501
28MV-22	7314150121410	2	48,45	501
28MV-8	7314150121274	2	36,51	501
28MV-9	7314150121281	2	36,51	501
29-B	7311518277703	1	32,32	328
2900-140	7314150121045	3	21,00	250
2900-150	7314150034499	3	21,00	250
2900-180	7314150034512	3	22,92	250
2900-215	7314150034536	3	28,30	250
2900-300	7314150121076	1	44,22	250
2928-1	7314150056583	1	15,38	250
2928-160	7314150056514	1	57,14	250
2928-2	7314150056590	1	15,38	250
2928-200	7314150056521	1	80,66	250
2928-250	7314150056538	1	115,36	250
2928-3	7314150056606	1	15,38	250
2928-4	7314150056613	1	15,38	250
2949-190IP	7314150123926	1	62,31	262
2949-200IP	7314150123940	1	66,10	262
2949-240IP	7314150123957	1	69,28	262
2949-250IP	7314150123971	1	86,07	262
2949-L075	7314150440559	1	5,72	263
2949-L120	7314150440566	1	5,96	263
2949-L200	7314150440573	1	7,33	263
2950-250	7314150124039	1	33,98	261
2951-140	7314150124084	1	18,13	259
2951-180	7314150102204	1	24,78	259
2951-250	7314150102211	1	28,54	259
2951-300	7314150102228	1	48,04	259
2951-S05	7314150447299	1	3,62	262
2951-S07	7314150447305	1	3,62	262
2951-S10	7314150447312	1	3,62	262
2951-S12	7314150447329	1	3,62	262
2952-165	7314150103836	1	21,58	260
2952-235	7314150103843	1	30,82	260
2953-140	7314150124046	1	16,93	259
2953-200	7314150124053	1	22,51	259
2953-250	7314150124060	1	25,69	259
2953-300	7314150124077	1	44,40	259
2955-250	7314150102235	1	32,47	260
2956-290	7314150413690	1	44,71	261
2957-250	7314150102259	1	27,03	260
2958-140	7314150124107	1	17,97	259
2958-200	7314150124114	1	24,78	259
2958-250	7314150102242	1	28,54	259
296	7311518034146	1	151,32	567
2960-280	7314150412808	1	54,25	261
2962-8-150	7314150412815	1	56,87	261
2962-8-230	7314150413706	1	73,09	261
2962-8-300	7314150413713	1	79,28	261
2963-280	7314150102280	1	37,91	261
2963-450	7314150124138	1	62,22	261
2963-630	7314150124145	1	74,83	261
2964-160	7314150124183	1	31,26	261
2964-280	7314150102297	1	41,22	261
2964-450	7314150124190	1	69,61	261
2964-600	7314150124206	1	81,53	261
2965-200	7314150124152	1	32,62	262
2965-280	7314150102266	1	43,20	262
2966-280	7314150102273	1	44,24	262
2967-180	7314150102396	1	39,27	260
2968-190	7314150124091	1	24,78	259
2968-235	7314150103850	1	28,54	259
2970G-200	7314150134946	5	17,24	241
2971G-250	7314150117154	5	15,53	248
2979 D-180	7314150034246	5	41,08	246
2990-125	7314150121250	3	21,51	250
2990-140	7314150034482	3	21,51	250
2990-180	7314150034505	3	24,17	250
2990-200	7314150034529	3	29,20	250
2990-300	7314150121267	1	43,05	250
2997-250	7314150124237	1	67,97	262
2997-300	7314150124244	5	74,89	262
2998-250	7314150124213	1	91,97	260
2998-SHN	7314150447275	1	53,65	260
2999-250	7314150124169	1	48,62	260
2999-SHN	7314150447282	1	14,31	260
29M-10	7314150122318	5	13,21	57
29M-11	7314150122325	5	13,71	57
29M-12	7314150122332	5	14,85	57
29M-13	7314150122349	5	15,40	57
29M-14	7314150122356	5	18,00	57
29M-15	7314150122363	5	19,07	57
29M-16	7314150122370	5	20,11	57
29M-17	7314150122387	5	20,29	57
29M-18	7314150122394	3	25,25	57
29M-19	7314150122400	3	26,65	57
29M-20	7314150122417	3	28,56	57
29M-21	7314150122424	3	31,05	57
29M-22	7314150122431	3	36,06	57
29M-23	7314150122448	3	37,55	57
29M-24	7314150122455	3	39,80	57
29M-25	7314150122462	3	45,42	57



29M-26	7314150122479	3	49,33	57
29M-27	7314150122486	3	53,87	57
29M-28	7314150122493	1	62,03	57
29M-29	7314150122509	1	70,73	57
29M-30	7314150122516	1	80,27	57
29M-32	7314150122523	1	95,67	57
29M-6	7314150122271	5	14,75	57
29M-7	7314150122288	5	15,36	57
29M-8	7314150122295	5	13,22	57
29M-9	7314150122301	5	13,13	57
29M/10	7314150122547	1	178,12	57
29M/14	7314150122554	1	309,50	57
29M/8	7314150122530	1	158,79	57
2M-10-11	7314151001223	5	12,03	52
2M-10-13	7314151001513	5	15,25	52
2M-12-13	7314151001230	5	12,93	52
2M-13-17	7314151343972	5	14,11	52
2M-14-15	7314151001247	5	13,71	52
2M-16-17	7314151001254	5	16,38	52
2M-16-18	7314151001575	5	19,57	52
2M-17-19	7314151000844	5	19,09	52
2M-18-19	7314151001261	5	19,09	52
2M-19-22	7314151000868	5	22,57	52
2M-20-22	7314151001278	5	23,42	52
2M-21-23	7314151001285	5	25,00	52
2M-22-24	7314151001612	5	27,27	52
2M-24-26	7314151001292	5	30,90	52
2M-24-27	7314151000899	5	31,38	52
2M-25-28	7314151001308	5	36,04	52
2M-27-29	7314150205332	5	37,07	52
2M-27-30	7314151001636	5	44,08	52
2M-27-32	7314151001322	5	44,08	52
2M-30-32	7314151000929	5	43,95	52
2M-32-36	7314151001667	1	64,57	52
2M-36-41	7314151001681	1	76,69	52
2M-41-46	7314151001704	1	101,37	52
2M-46-50	7314151001711	1	125,12	52
2M-6-7	7314151001209	5	10,38	52
2M-8-10	7314151001506	5	13,18	52
2M-8-9	7314151001216	5	11,37	52
2M/10T	7314150212996	1	180,51	52
2M/12T	7314151001414	1	259,43	53
2M/8T	7314151001391	1	122,05	52
2M/S8	7314151827335	1	117,86	52
2MV-10	7314150121113	5	30,73	501
2MV-11	7314150121120	5	31,01	501
2MV-12	7314150121137	5	31,01	501
2MV-13	7314150121144	5	33,26	501
2MV-14	7314150121151	5	34,19	501
2MV-15	7314150121168	5	35,46	501
2MV-16	7314150121175	5	35,95	501
2MV-17	7314150121182	3	37,05	501
2MV-18	7314150121199	3	37,71	501
2MV-19	7314150121205	3	38,97	501
2MV-21	7314150121212	3	41,01	501
2MV-22	7314150121229	3	41,32	501
2MV-23	7314150121236	3	44,02	501
2MV-24	7314150121243	3	45,44	501
2MV-6	7314150121069	5	28,70	501
2MV-7	7314150121083	5	28,70	501
2MV-8	7314150121090	5	30,22	501
2MV-9	7314150121106	5	30,82	501
2Z-1-1.1/8	7314151001827	1	36,83	52
2Z-1.1/16-1.1/4	7314151001834	1	40,75	52
2Z-1/2-9/16	7314151001445	1	13,15	52
2Z-1/4-5/16	7314151001421	1	11,85	52
2Z-13/16-7/8	7314151001797	1	22,57	52
2Z-15/16-1	7314151001810	1	31,08	52
2Z-3/4-7/8	7314151001773	1	22,57	52
2Z-3/8-7/16	7314151001438	1	13,25	52
2Z-5/16-3/8	7314151001728	1	11,58	52
2Z-5/8-11/16	7314151001452	1	16,81	52
2Z-9/16-5/8	7314151001735	1	14,11	52
2Z/7T	7314150217373	1	108,23	53
3-24-51	7315962500028	5	18,45	633
3-330-12-1-0	7311518020712	5	26,59	31
3-330-12-2-0	7311518020729	5	28,39	31
3-330-14-1-0	7311518020736	5	28,57	31
3-330-14-2-0	7311518020743	5	32,80	31
3-331-14-1-0	7311518020750	5	29,11	31
300-14-F15/16-HP	7311518005955	4	20,02	561
301	7311518001384	50	18,81	567
301-16	7314150456048	12	27,36	269
301-22	7311518293673	12	26,12	269
302	7311518013349	30	18,37	566
302-15-95	7314150486632	100	6,36	269
302-35	7311518293680	6	41,52	269
302-511W-12P	7311518207786	1	4,56	567
302-51W-12P	7311518013356	1	3,14	567
302-53W-12P	7311518013363	1	3,14	567
302-55W-12P	7311518013370	1	3,14	567
302-57W-12P	7311518013387	1	3,71	567
302-59W-12P	7311518207779	1	4,21	567
302-6X4P	7311518017590	1	10,01	567
302-71M-12P	7311518013394	1	5,22	567
302-73M-12P	7311518013400	1	5,23	567

			€	
302-75M-12P	7311518013417	1	6,29	567
302-76-95	7314150188345	1	6,12	269
302-76N	7314150456307	6	94,54	269
302-77M-12P	7311518207793	1	6,80	567
302-81S-12P	7311518013677	1	4,44	567
302-83S-12P	7311518013684	1	4,44	567
302-85S-12P	7311518207809	1	5,02	567
302-95-SET	7314150456321	1	24,87	269
303-5P	7311518031435	10	5,05	567
304	7311518265533	10	7,89	556
3045/1VDE	7314151783815	1	443,51	504
3045V-1	7314150128785	1	303,63	504
3045V-2	7314150128792	1	759,63	504
3046-OP	7311518276980	12	40,04	361
3046-REF	7311518276966	1	133,31	309
3049-2	7314151848118	1	538,96	464
306	7311518265540	10	15,14	556
306-10	7314150120246	1	31,36	268
306-12	7314150120253	1	33,14	268
306-15	7311518297107	12	34,89	268
306-15-95	7311518297329	1	12,06	269
306-22	7311518297114	12	38,37	268
306601500	8413345098700	5	22,08	588
306602000	8413345098717	5	23,74	588
306603000	8413345217033	5	26,71	588
306604000	8413345217095	5	29,38	588
306703000	8413345217194	5	28,78	588
306704000	8413345098755	5	31,16	588
306705000	8413345098762	5	33,97	588
306706000	8413345098779	5	36,20	588
306708000	8413345098786	5	41,53	588
306710000	8413345098793	5	47,19	588
306712000	8413345123334	2	53,11	588
306715000	8413345123341	2	60,82	588
306803000	8413345098809	5	51,48	588
306804000	8413345098816	5	54,90	588
306805000	8413345098823	2	58,04	588
306806000	8413345098830	2	60,74	588
306808000	8413345098847	2	66,59	588
306810000	8413345098854	2	71,71	588
306812000	8413345098861	2	76,09	588
306815000	8413345098878	1	82,73	588
306820000	8413345098885	1	90,85	588
306903000	8413345123402	2	82,77	588
306904000	8413345123419	2	85,88	588
306905000	8413345123426	2	88,99	588
306906000	8413345123433	2	91,98	588
306908000	8413345123457	2	98,06	588
306910000	8413345123471	2	103,99	588
307401B	7314150254958	1	34,16	268
307411B	7314150254965	1	51,07	268
307421B	7314150254972	1	82,35	268
307431B	7314150254989	1	136,83	268
307441	7314150235933	1	186,59	268
307451	7314150235940	1	273,66	268
308504000	8413345035156	1	19,08	544
308505000	8413345035194	1	20,94	544
308506000	8413345035163	1	24,19	544
308508000	8413345035170	1	29,43	544
308510000	8413345035187	1	33,04	544
3090-20-XT11-HP	7311518181369	4	55,49	563
31	7314150004942	5	37,25	40
31 IP	7314150004959	50	35,87	40
31-T	7314150483709	5	35,87	40
31-T IP	7314150483723	50	35,87	40
3100TB	7314150125364	1	61,13	466
310M-24	7314151829612	1	56,13	56
310M-27	7314151829629	1	56,13	56
310M-30	7314151829636	1	56,13	56
310M-32	7314151829643	1	59,59	56
310M-36	7314151829650	1	68,16	56
310M-38	7314151829667	1	82,01	56
310M-41	7314151829674	1	83,76	56
310M-46	7314151829681	1	93,39	56
310M-50	7314151829698	1	112,45	56
310M-55	7314151829704	1	125,86	56
310M-60	7314151829711	1	154,83	56
310M-65	7314151829728	1	175,07	56
310M-70	7314151829735	1	190,84	56
310M-75	7314151829742	1	208,17	56
310M-80	7314151829759	1	228,69	56
310M-85	7314151829766	1	246,05	56
310M-90	7314151829773	1	488,93	56
310M-95	7314151829780	1	529,93	56
311-32	7314150120215	6	21,63	270
3115	7314150055326	1	357,63	364
3149-OR	7311518292249	1	45,14	461
3149-ORFF1	7314150292479	1	561,43	460
3149-ORTS1	7314150292066	1	372,38	461
3150-12-XT9-HP	7311518181406	4	35,66	560
315M-27	7314150133291	1	75,44	56
315M-30	7314150133307	1	76,87	56
315M-32	7314150133314	1	75,44	56
315M-36	7314150133321	1	104,43	56
315M-41	7314150133345	1	107,36	56
315M-46	7314150133352	1	139,28	56

			€	
315M-50	7314150133369	1	156,67	56
315M-55	7314150133376	1	179,89	56
315M-60	7314150133383	1	232,10	56
315M-65	7314150133390	1	264,01	56
315M-70	7314150133406	1	307,54	56
315M-75	7314150133413	1	319,16	56
315M-80	7314150133420	1	368,46	56
315Z-1.1/16	7314150133437	1	69,63	56
315Z-1.1/2	7314150133450	1	94,21	56
315Z-1.1/4	7314150133468	1	75,44	56
315Z-1.1/8	7314150133444	1	69,63	56
315Z-1.1.11/16	7314150133529	1	113,17	56
315Z-1.1.13/16	7314150133543	1	124,75	56
315Z-1.1.15/16	7314150133567	1	136,34	56
315Z-1.3/16	7314150133451	1	72,54	56
315Z-1.3/4	7314150133536	1	121,86	56
315Z-1.3/8	7314150133482	1	98,63	56
315Z-1.5/16	7314150133475	1	78,34	56
315Z-1.5/8	7314150133512	1	110,26	56
315Z-1.7/16	7314150133499	1	92,59	56
315Z-1.7/8	7314150133550	1	133,46	56
315Z-2	7314150133574	1	136,34	56
315Z-2.1/16	7314150133581	1	139,28	56
315Z-2.1/2	7314150133642	1	205,99	56
315Z-2.1/4	7314150133611	1	159,57	56
315Z-2.1/8	7314150133598	1	140,63	56
315Z-2.15/16	7314150133697	1	258,21	56
315Z-2.3/16	7314150133604	1	152,36	56
315Z-2.3/4	7314150133673	1	214,71	56
315Z-2.3/8	7314150133635	1	168,29	56
315Z-2.5/16	7314150133628	1	162,47	56
315Z-2.5/8	7314150133666	1	214,71	56
315Z-2.7/8	7314150133680	1	255,32	56
315Z-2.9/16	7314150133659	1	211,80	56
315Z-3	7314150133703	1	264,01	56
315Z-3.1/8	7314150133840	1	269,82	56
316-1	7311518296216	12	13,38	271
316-2	7311518296223	12	20,05	271
316-2-95	7311518296278	1	10,56	271
317	7311518240936	10	19,50	556
317-40	7311518296230	12	13,48	271
318-38	7311518296247	1	84,17	271
318-54	7311518296254	1	134,86	271
3180-14-XT11-HP	7311518181390	4	50,20	562
319	7311518240943	5	26,91	556
320	7311518265557	10	22,40	556
321	7311518001841	5	35,64	556
321-18-SB	7311518129125	10	18,99	558
321-24-SB	7311518129132	10	19,30	558
321-7-SB	7311518129149	10	17,81	558
322500300	8413345012829	1	44,04	535
322500500	8413345012836	1	46,67	535
322500800	8413345012843	1	49,64	535
322510300	8413345015899	1	8,61	535
322510400	8413345137386	1	8,61	535
322510500	8413345015905	1	8,61	535
322510600	8413345137393	1	8,61	535
322510700	8413345137409	1	8,61	535
322510800	8413345015912	1	8,61	535
3240-14-XT11-HP	7311518243005	4	42,34	562
325	7311518214852	5	48,23	556
325001000	8413345000505	1	83,42	535
3250010SH	8413345137492	1	4,68	535
326000200	8413345000529	1	51,25	535
326000300	8413345012881	1	55,58	535
326010200	8413345016100	1	7,49	535
326020200	8413345016117	1	7,55	535
326030200	8413345016124	1	7,55	535
327020500	7314150330584	1	105,91	535
327020500-SH1	7314150361021	1	8,02	535
327020500-SH2	7314150361038	1	8,02	535
327020500-SH3	7314150361045	1	8,02	535
327020500-SH4	7314150361052	1	8,02	535
3280M	7314151071318	1	16,96	50
329000330	8413345000741	1	4,52	535
329000500	8413345000758	1	5,58	535
331-15-23	7311518274658	5	14,48	633
331-21-51-KP	7311518003814	5	15,49	633
332-21-51	7311518229337	5	18,34	633
333	7311518005832	5	29,45	633
333-5	7311518005849	10	7,29	634
339-6T	7311518128371	4	17,63	629
33H	7314150266791	5	66,38	40
340-6T	7311518002008	4	18,81	629
341	7314150113729	1	52,86	266
341 A	7314150216260	6	44,09	252
3416 A SH	7314150410941	1	16,68	252
3416 B	7314150411160	10	152,71	252
3416 B SH	7314150411191	10	59,49	252
3417 A	7314150216277	12	29,15	253
3418 A	7314150216284	1	35,19	252
3419 B	7314151812416	1	119,31	254
3419 B SH	7314150504381	1	36,18	254
341A	7314150476268	5	167,22	653
342	7314150113736	1	59,48	266
343	7314150113743	1	80,00	266





344	7314150113750	1	119,73	266
349	7311518018924	4	18,67	634
3517 A	7314150410910	1	34,89	253
3518 A	7314150216376	1	24,33	253
3518 A SH	7314150216383	1	5,70	253
3518 B	7314150410927	1	44,35	253
3520 A	7314150410934	1	33,74	252
3520 A SH	7314150410958	1	5,67	252
3520 B	7314150411177	10	103,61	252
3520 B SH	7314150411207	10	29,69	252
3524	7314151073336	1	34,88	536
3524L-K	7314151339807	1	16,75	536
3525HB	7314151073350	5	27,03	536
36	7314150223381	5	45,63	593
361-10	7311518295202	1	33,17	267
361-12	7311518295219	1	38,69	267
361-14	7311518295226	1	41,48	267
361-18	7311518295233	1	58,04	267
361-24	7311518295240	1	96,46	267
361-36	7311518295257	1	185,69	267
361-8	7311518295196	1	29,83	267
3619 A	7314150411184	10	52,34	253
3619 A SH	7314150411214	10	14,19	253
3625AR-35	7314150214723	34	34,29	596
3625AR-50	7314150214730	18	56,64	596
3625AR-60	7314150214747	12	73,69	596
3625ARL-35	7314150214754	6	1,40	596
3625ARL-50	7314150214761	6	5,54	596
3625ARL-60	7314150214778	6	9,27	596
3625ARLH-35	7314150218677	80	4,60	597
3625ARLH-50	7314150218684	50	4,86	597
3625ARLH-60	7314150218691	16	5,12	597
3625N-22	7314151073602	6	44,91	597
3625N-32	7314151073640	6	48,51	597
3625N-40	7314151073688	6	81,63	597
3625N-50	7314151073701	6	98,91	597
3625NL-22	7314151073831	20	12,59	598
3625NL-32	7314151073855	20	21,46	598
3625NL-40	7314151073879	20	37,29	598
3625NL-50	7314151073886	20	62,26	598
3625PU-105	7314150170098	4	250,37	597
3625PU-30	7311518276119	12	30,65	597
3625PU-50	7311518276126	6	50,59	597
3625PU-60	7311518276133	6	76,31	597
3625RM-55	7314150120758	50	10,91	598
3625RM-65	7314150120765	40	11,78	598
3625RM-75	7314153019820	30	14,12	598
3625RM-90	7314150120390	20	17,15	598
3625S-28	7314150183906	50	23,50	598
3625S-35	7314150183913	30	31,34	598
3625S-44	7314150183920	18	44,37	598
3625W-22	7314150120406	120	11,01	598
3625W-28	7314150120413	1	15,74	598
3625W-35	7314150120420	1	19,83	598
3625W-44	7314150120437	1	28,94	598
3625W-55	7314150120444	12	55,66	598
3625WL-22	7314150120451	10	4,19	598
3625WL-28	7314150120468	10	4,65	598
3625WL-35	7314150120475	10	5,66	598
3625WL-44	7314150120482	10	6,19	598
3625WL-55	7314150120499	6	8,19	598
3625WLH-22	7314150219025	50	3,39	598
3625WLH-28	7314150218981	50	3,57	598
3625WLH-35	7314150218998	80	3,83	598
3625WLH-44	7314150219001	50	4,48	598
3625WLH-55	7314150219018	16	4,74	598
3625Y-22	7314151074074	6	42,22	597
3625Y-32	7314151074098	6	60,56	597
3625Y-40	7314151074111	6	83,69	597
3625Y-50	7314151074128	6	117,95	597
3625YL-22	7314151074159	20	17,04	597
3625YL-32	7314151074173	20	29,59	597
3625YL-40	7314151074197	20	52,67	597
3625YL-50	7314151074203	20	87,32	597
363-32	7311518295578	1	47,03	268
3640-150-C	7314150180691	25	16,44	604
3640-200-C	7314150180714	25	18,94	604
3640-250-C	7314150180721	20	22,48	604
3640-300-C	7314150180738	25	28,80	604
3643-100	7314151074654	50	17,89	606
3643-120	7314151074678	50	20,14	606
3643-150	7314151074685	50	25,75	606
3644-120	7314151074708	50	15,00	606
3644-125	7314151074722	50	17,70	606
3644-130	7314151074746	50	21,40	606
3644-150	7314151074760	50	23,01	606
3644-165	7314151074777	50	23,72	606
3644-180	7314151074791	50	31,70	606
3644-200	7314151074807	50	35,93	606
3646-115	7314151074937	250	17,89	607
3646-125	7314151074944	250	17,89	607
3646-150	7314151074951	125	17,97	607
3646-165	7314151074968	125	18,14	607
3646-180	7314151074975	50	20,75	607
3646-200	7314151074982	50	24,92	607
3646/6	7314151074999	25	142,82	607



3649-125	7314150472413	50	9,59	604
3654BMS/7	7314150220816	1	99,95	610
3654R	7314151075132	1	158,47	607
3656-125	7314150472352	50	9,59	604
3656-150	7314150472376	50	13,54	604
3656-175	7314150472390	1	9,59	604
3656/10	7314151075279	1	262,02	608
3658A-2	7314151075293	125	18,17	607
3658A-3	7314151075309	125	18,36	607
3658A-4	7314151075316	125	18,36	607
3658A-5	7314151075323	125	18,43	607
3658A-6	7314151075330	125	18,43	607
3658A-8	7314151075347	50	18,43	607
3658A/6	7314151075354	30	135,80	608
3659-0.9	7314151075507	5	12,13	607
3659-1.4	7314151075514	5	12,35	607
3659-1.8	7314151597351	5	12,70	607
3659-2.4	7314151075538	5	13,65	607
3659-2.8	7314151597436	5	14,39	607
3659-3.4	7314151075552	5	14,69	607
3659-3.9	7314151075569	5	13,54	607
3659-6.0	7314151075576	5	14,96	607
3659/8	7314151075583	1	113,78	608
3659/8T	7314151472573	1	108,85	608
3680	7314151075835	1	64,33	370
3681-11	7314150132980	1	31,92	371
3681-16	7314150132997	1	38,32	371
3681-20	7314150133000	1	47,89	371
3683	7314151075866	1	53,27	370
3684-16	7314150133017	1	24,53	370
3684-18	7314150133024	1	33,71	370
3684-24	7314150133031	1	43,75	370
3684-30	7314150133048	1	73,52	370
369-BLADE	7311518016531	20	19,55	561
370-4	7311518296193	1	47,03	268
3717 A	7314150489916	1	27,56	253
3718 A	7314150489930	12	51,18	254
3719 A	7314150489954	12	39,37	254
372-1.1/2	7314150133239	1	113,33	267
372-12	7314150133284	1	1.069,31	267
372-2.1/2	7314150133246	1	209,68	267
372-4	7314150133253	1	267,31	267
372-6	7314150133260	1	459,27	267
372-8	7314150133277	1	621,59	267
3733-2	7314151834371	50	5,05	607
3733-3	7314151834388	50	5,05	607
3733-4	7314151834395	50	4,95	607
3733-5	7314151834401	50	4,95	607
3733-6	7314151834418	50	4,95	607
3733S/5	7314150220809	25	26,81	608
3734-2	7314151834296	50	8,54	607
3734-3	7314151834319	50	8,54	607
3734-4	7314151834326	50	8,54	607
3734-5	7314151834333	50	8,54	607
3734-6	7314151834340	50	8,54	607
3734-8	7314151834357	50	8,73	607
3734BMS/7	7314150220755	1	97,41	610
3734N-10-150	7314150218110	10	7,57	607
3734N-2-150	7314150218042	10	6,14	607
3734N-3-150	7314150218059	10	6,14	607
3734N-4-150	7314150218066	10	6,34	607
3734N-5-150	7314150218073	10	6,34	607
3734N-6-150	7314150218080	10	7,57	607
3734N-7-150	7314150218097	10	7,57	607
3734N-8-150	7314150218103	10	7,57	607
3734N-9-150	7314150218127	10	7,57	607
3734NS/9	7314150218134	10	62,16	608
3734S/6	7314151834470	5	67,22	608
3735-4-120	7314151834265	50	5,32	606
3735-5-120	7314151834272	50	6,56	606
3735-5-150	7314151834289	50	8,73	606
3735N-2-100	7314150217953	10	5,54	606
3735N-4-120	7314150217960	10	6,16	606
3735N-5-120	7314150217977	10	6,96	606
3735N-6-150	7314150217984	10	7,57	606
3735N-8-150	7314150217991	10	7,57	606
3735NS/4	7314150218004	25	27,62	606
3736M-200	7314150220878	30	15,78	605
3736M-250	7314151834142	25	20,74	605
3736M-300	7314151834159	10	27,49	605
3736M-400	7314151834166	10	36,25	605
3736MH-250	7314151834173	10	28,58	605
3736MH-300	7314151834180	10	35,13	605
3736MH-400	7314151834197	5	43,96	605
3736S/6	7314151834463	5	60,37	605
3739-250	7314151834203	25	20,84	605
3739-300	7314151834210	10	27,60	605
3739-400	7314151834227	10	36,45	605
3739H-250	7314151834234	15	28,74	605
3739H-300	7314151834241	10	35,32	605
3739H-400	7314151834258	10	44,18	605
3740-100	7314151834005	50	9,17	604
3740-125	7314151834012	50	11,05	604
3740-150	7314151834029	50	12,63	604
3740-175	7314151834036	25	13,37	604
3740-200	7314151834043	25	14,50	604



3740-250	7314151834050	10	15,26	604
3740-300	7314151834067	10	16,32	604
3745-150	7314151834081	50	13,64	604
3745-175	7314151834098	25	17,43	604
3745-200	7314151834104	20	18,49	604
3745-250	7314151834111	10	26,05	604
3749-125	7314150457915	50	6,85	604
375-8	7311518296209	1	47,03	268
3750	7314151834128	25	18,07	604
3750H	7314151834135	25	26,32	605
3756-125	7314150457892	50	6,85	604
3756-150	7314150457908	50	8,50	604
38-12	7314151831264	5	20,20	331
38-16	7314151831271	5	25,59	331
38-20	7314151831288	2	32,32	331
38-24	7314151831295	1	40,39	331
38-8	7314151831257	5	16,15	331
380-10	7314150133178	1	45,14	267
380-14	7314150133185	1	60,00	267
380-18	7314150133192	1	85,71	267
380-24	7314150133208	1	142,80	267
380-36	7314150133215	1	276,19	267
380-48	7314150133222	1	406,67	267
3802-300-25-1.25-10	7311518111229	10	11,89	19
3802-300-25-1.25-14	7311518111236	10	11,94	19
3802-300-25-1.25-6	7311518143299	10	11,89	19
3802-300-32-1.60-10	7311518111274	10	17,40	19
3802-300-32-1.60-6	7311518111298	10	17,15	19
3802-350-25-1.25-10	7311518111335	10	13,97	19
3802-350-25-1.25-14	7311518111342	10	13,97	19
3802-350-25-1.25-6	7311518111359	10	13,97	19
3802-350-32-1.60-10	7311518111397	10	18,42	19
3802-350-32-1.60-14	7311518111403	10	18,42	19
3802-350-32-1.60-4	7311518111410	10	18,42	19
3802-350-32-1.60-6	7311518111427	10	18,42	19
3802-350-32-1.60-8	7311518140908	10	18,42	19
3802-400-25-1.25-10	7311518111496	10	17,81	19
3802-400-25-1.25-14	7311518111502	10	17,81	19
3802-400-25-1.25-6	7311518111519	10	17,81	19
3802-400-32-1.60-10	7311518111557	10	23,25	19
3802-400-32-1.60-14	7311518111564	10	23,25	19
3802-400-32-1.60-4	7311518111571	10	23,25	19
3802-400-32-1.60-6	7311518111588	10	23,25	19
3802-400-32-1.60-8	7311518111595	10	23,25	19
3802-400-38-2.00-10	7311518111649	10	31,05	19
3802-400-38-2.00-4	7311518111656	10	31,05	19
3802-400-38-2.00-6	7311518111663	10	31,05	19
3802-425-32-1.60-10	7311518111694	10	28,08	19
3802-425-32-1.60-6	7311518111700	10	27,59	19
3802-450-32-1.60-10	7311518111731	10	29,06	19
3802-450-32-1.60-14	7311518111748	10	29,06	19
3802-450-32-1.60-4	7311518111755	10	29,06	19
3802-450-32-1.60-6	7311518111762	10	29,06	19
3802-450-38-2.00-10	7311518111816	10	38,98	19
3802-450-38-2.00-10-KA	7311518111823	10	38,98	19
3802-450-38-2.00-4	7311518111830	10	38,98	19
3802-450-38-2.00-4-KA	7311518111847	10	38,98	19
3802-450-38-2.00-6	7311518111854	10	38,98	19
3802-450-38-2.00-6-KA	7311518111861	10	38,98	19
3802-450-38-2.00-8	7311518111878	10	38,98	19
3802-450-38-2.00-8-KA	7311518111885	10	38,98	19
3802-475-38-2.00-8	7311518113117	10	41,71	19
3802-500-38-2.00-10	7311518111953	10	45,78	19
3802-500-38-2.00-4	7311518111960	10	45,78	19
3802-500-38-2.00-6	7311518111977	10	45,78	19
3802-500-38-2.00-8	7311518113070	10	45,78	19
3802-500-45-2.25-10	7311518111984	10	64,49	19
3802-500-50-2.50-4	7311518112028	10	69,05	19
3802-500-50-2.50-4-KA	7311518112035	10	69,05	19
3802-500-50-2.50-6	7311518112042	10	69,05	19
3802-500-50-2.50-6-KA	7311518112059	10	69,05	19
3802-525-38-2.00-10	7311518112073	10	48,09	19
3802-525-38-2.00-6	7311518112097	10	47,63	19
3802-525-38-2.00-8	7311518112103	10	42,64	19
3802-550-38-2.00-6	7311518112158	10	44,81	19
3802-550-50-2.50-10	7311518112196	10	77,84	19
3802-550-50-2.50-4	7311518112202	10	75,93	19
3802-550-50-2.50-4-KA	7311518112219	10	76,31	19
3802-550-50-2.50-6	7311518112226	10	76,31	19
3802-550-50-2.50-8	7311518112240	5	77,84	19
3802-550-50-2.50-8-KA	7311518113315	10	76,31	19
3802-575-50-2.50-3-KA	7311518112301	10	79,78	19
3802-575-50-2.50-4	7311518112318	10	79,78	19
3802-575-50-2.50-4-KA	7311518112325	10	79,78	19
3802-575-50-2.50-6	7311518112332	10	79,78	19
3802-575-50-2.50-6-KA	7311518112349	10	79,78	19
3802-600-50-2.50-4	7311518112417	10	84,98	19
3802-600-50-2.50-6	7311518112431	10	84,98	19
3802-600-50-2.50-8	7311518112455	10	84,98	19
3802-650-50-2.50-4	7311518112509	5	94,50	19
3802-650-50-2.50-4-KA	7311518112523	5	94,50	19
3802-650-50-2.50-6	7311518112530	5	94,50	19
3802-650-50-2.50-6-KA	7311518112554	5	86,26	19
3802-700-50-2.50-2-KA	7311518112578	5	102,87	19
3802-700-50-2.50-3	7311518112585	5	90,79	19
3802-700-50-2.50-4	7311518112608	5	103,30	19



3802-700-50-2.50-4-KA	7311518112615	5	103,30	19
3802-700-50-2.50-6	7311518112622	5	103,30	19
3802-700-50-2.50-6-KA	7311518112639	5	103,30	19
3802-750-50-2.50-4	7311518112660	5	120,49	19
3802-750-50-2.50-6	7311518112677	5	110,04	19
3806-600-32	7311518018092	10	26,16	557
3809-300-25-1.25-10	7311518113711	10	10,71	18
3809-300-25-1.25-14	7311518113728	10	10,77	18
3809-300-32-1.60-10	7311518113735	10	15,44	18
3809-300-32-1.60-6	7311518113742	10	15,32	18
3809-350-25-1.25-10	7311518113759	10	12,50	18
3809-350-25-1.25-14	7311518113766	10	12,50	18
3809-350-25-1.25-6	7311518113773	10	12,50	18
3809-350-32-1.60-10	7311518113780	10	16,48	18
3809-350-32-1.60-14	7311518113797	10	16,48	18
3809-350-32-1.60-4	7311518113803	10	16,48	18
3809-350-32-1.60-6	7311518113810	10	16,48	18
3809-350-32-1.60-8	7311518113827	10	16,48	18
3809-350-32-2.00-10	7311518113834	10	22,08	18
3809-350-32-2.00-4	7311518113841	10	22,08	18
3809-350-32-2.00-6	7311518113858	10	22,08	18
3809-350-38-2.00-10	7311518113865	10	27,66	18
3809-350-38-2.00-6	7311518113889	10	27,66	18
3809-400-25-1.25-10	7311518178666	10	15,91	18
3809-400-32-1.60-10	7311518113896	10	20,94	18
3809-400-32-1.60-14	7311518113902	10	20,94	18
3809-400-32-1.60-4	7311518113919	10	20,94	18
3809-400-32-1.60-6	7311518113933	10	20,94	18
3809-400-32-1.60-8	7311518113940	10	20,94	18
3809-400-32-2.00-10	7311518113957	10	24,56	18
3809-400-32-2.00-4	7311518113964	10	24,56	18
3809-400-32-2.00-6	7311518113971	10	24,56	18
3809-400-32-2.00-6-KA	7311518158248	10	24,59	19
3809-400-32-2.00-8	7311518114152	10	25,05	18
3809-400-38-2.00-10	7311518113988	10	28,00	18
3809-400-38-2.00-4	7311518113995	10	28,00	18
3809-400-38-2.00-6	7311518114008	10	28,00	18
3809-425-32-1.60-10	7311518114015	10	28,00	18
3809-425-32-1.60-6	7311518197759	10	24,73	18
3809-450-32-1.60-10	7311518114022	10	26,16	18
3809-450-32-1.60-14	7311518114039	10	26,16	18
3809-450-32-1.60-4	7311518114046	10	26,16	18
3809-450-32-1.60-6	7311518114053	10	26,16	18
3809-450-32-2.00-10	7311518114060	10	30,83	18
3809-450-32-2.00-4	7311518114077	10	30,83	18
3809-450-32-2.00-6	7311518114084	10	30,83	18
3809-450-38-2.00-10	7311518114091	10	35,06	18
3809-450-38-2.00-10-KA	7311518114107	10	35,06	19
3809-450-38-2.00-4	7311518114114	10	35,06	18
3809-450-38-2.00-4-KA	7311518114121	10	35,06	19
3809-450-38-2.00-6	7311518114138	10	35,06	18
3809-450-38-2.00-6-KA	7311518114145	10	35,06	18
3809-450-38-2.00-8	7311518114176	10	35,06	18
3809-450-45-2.25-4	7311518114206	10	43,92	18
3809-450-45-2.25-6	7311518114213	10	43,92	18
3809-475-45-2.25-6	7311518114237	10	50,75	18
3809-500-38-2.00-10	7311518114244	10	40,96	18
3809-500-38-2.00-4	7311518114251	10	40,96	18
3809-500-38-2.00-6	7311518114268	10	40,96	18
3809-500-45-2.25-4	7311518114275	10	52,47	18
3809-500-45-2.25-6	7311518114299	10	52,47	18
3809-500-45-2.25-6-KA	7311518114305	10	52,47	19
3809-500-50-2.50-4	7311518114312	10	62,01	18
3809-500-50-2.50-4-KA	7311518114329	10	62,01	19
3809-500-50-2.50-6	7311518114336	10	62,01	18
3809-500-50-2.50-6-KA	7311518114343	10	62,01	19
3809-500-50-2.50-8	7311518114350	10	62,93	18
3809-525-38-2.00-10	7311518114367	10	42,81	18
3809-525-38-2.00-6	7311518114374	10	42,81	18
3809-525-45-2.25-4	7311518114381	10	54,85	18
3809-525-45-2.25-6	7311518114398	10	54,85	18
3809-550-45-2.25-4	7311518114411	10	57,69	18
3809-550-45-2.25-6	7311518114428	10	57,69	18
3809-550-50-2.50-4	7311518114435	10	68,75	18
3809-550-50-2.50-4-KA	7311518114442	10	68,75	19
3809-550-50-2.50-6	7311518114459	10	68,75	18
3809-550-50-2.50-6-KA	7311518114466	10	68,75	19
3809-575-45-2.25-4	7311518114473	10	62,84	18
3809-575-50-2.50-10-KA	7311518114497	10	71,69	18
3809-575-50-2.50-3	7311518114602	10	71,69	

3809-650-50-2.50-6



3809-650-50-2.50-6	7311518114671	5	84,90	18
3809-650-50-2.50-6-KA	7311518114688	5	84,90	19
3809-700-50-2.50-3-KA	7311518114695	5	92,76	19
3809-700-50-2.50-4	7311518114701	5	92,76	18
3809-700-50-2.50-4-KA	7311518114718	5	92,76	19
3809-700-50-2.50-6	7311518114725	5	92,76	18
3809-700-50-2.50-6-KA	7311518114732	5	92,76	19
3809-750-50-2.50-4	7311518114749	5	108,25	18
3809-750-50-2.50-6	7311518234409	5	108,25	18
3815-200-2,0-32-1-03BW	7311518160258	1	82,95	17
3815-200-2,0-32-1-04BW	7311518160241	1	103,69	17
3815-225-2,0-32-1-03BW	7311518160319	1	125,59	17
3815-225-2,0-32-1-04BW	7311518158347	1	125,59	17
3815-225-2,0-32-1-05BW	7311518160302	1	125,59	17
3815-225-2,0-32-1-06C	7311518160296	1	125,59	17
3815-250-2,0-32-1-03BW	7311518160586	1	137,78	17
3815-250-2,0-32-1-04BW	7311518160579	1	137,78	17
3815-250-2,0-32-1-05BW	7311518158354	1	137,78	17
3815-250-2,0-32-1-06C	7311518160562	1	137,78	17
3815-250-2,0-40-2-03BW	7311518160340	1	137,78	18
3815-250-2,0-40-2-04BW	7311518174446	1	137,78	18
3815-250-2,0-40-2-05BW	7311518160333	1	137,78	18
3815-275-2,5-32-1-04BW	7311518160593	1	190,83	17
3815-275-2,5-32-1-05BW	7311518158361	1	190,83	17
3815-275-2,5-32-1-06C	7311518174590	1	190,83	17
3815-275-2,5-32-1-08C	7311518174583	1	190,83	17
3815-275-2,5-40-2-03BW	7311518176433	1	190,83	18
3815-275-2,5-40-2-04BW	7311518160623	1	190,83	18
3815-275-2,5-40-2-05BW	7311518158378	1	190,83	18
3815-275-2,5-40-2-06C	7311518160616	1	190,83	18
3815-275-2,5-40-2-08C	7311518160609	1	190,83	18
3815-300-2,5-32-1-04BW	7311518160630	1	235,28	17
3815-300-2,5-32-1-05BW	7311518158385	1	235,28	17
3815-300-2,5-32-1-05C	7311518174699	1	235,28	17
3815-300-2,5-32-1-06C	7311518174705	1	235,28	17
3815-300-2,5-32-1-08C	7311518174712	1	235,28	17
3815-315-2,5-32-1-04BW	7311518160210	1	283,90	17
3815-315-2,5-32-1-05BW	7311518160203	1	283,90	17
3815-315-2,5-32-1-06C	7311518160197	1	283,90	17
3815-315-2,5-32-1-08C	7311518160401	1	283,90	17
3815-315-2,5-40-2-04BW	7311518160456	1	283,90	18
3815-315-2,5-40-2-05BW	7311518160449	1	283,90	18
3815-315-3,0-40-2-06C	7311518174842	1	302,96	17
3815-350-2,5-32-1-04BW	7311518197605	1	397,76	18
3815-350-2,5-32-1-06C	7311518197612	1	397,76	17
3815-370-3,0-50-4-08C	7311518174989	1	397,76	18
3815-370-3,0-50-4-10C	7311518174996	1	397,76	18
3815-400-3,5-50-4-10C	7311518160494	1	522,87	18
3816-300	7311518015749	50	12,83	558
3818-300-PROG-100	7311518288105	100	2,30	557
3818-300-PROG-5P	7314150265589	10	14,44	557
383-6T	7311518128876	4	19,98	630
3830-102-C	7311518225612	1	34,74	124
3830-102-VIP	7311518042035	4	34,74	124
3830-105-C	7311518225629	1	36,63	124
3830-105-VIP	7311518042042	4	36,63	124
3830-108-C	7311518228521	1	42,82	124
3830-108-VIP	7311518042059	4	42,82	124
3830-111-C	7311518228538	1	49,89	124
3830-111-VIP	7311518042066	4	49,89	124
3830-114-C	7311518225636	1	55,58	124
3830-114-VIP	7311518042073	4	55,58	124
3830-121-C	7311518225643	1	61,89	124
3830-121-VIP	7311518042080	1	61,89	124
3830-127-C	7311518225650	1	67,57	124
3830-127-VIP	7311518042097	1	67,57	124
3830-133-C	7311518228545	1	72,62	124
3830-133-VIP	7311518042103	1	72,62	124
3830-14-C	7311518228347	1	11,87	124
3830-14-VIP	7311518041618	6	11,87	124
3830-140-C	7311518228552	1	77,67	124
3830-140-VIP	7311518042110	1	77,67	124
3830-146-C	7311518228569	1	80,83	124
3830-146-VIP	7311518042127	1	80,83	124
3830-152-C	7311518225667	1	88,41	124
3830-152-VIP	7311518042134	1	88,41	124
3830-16-C	7311518225353	1	11,87	124
3830-16-VIP	7311518041625	6	11,87	124
3830-168	7311518040659	1	114,84	124
3830-17-C	7311518228354	1	11,87	124
3830-17-VIP	7311518041632	6	11,87	124
3830-177-HIGH	7311518101329	1	158,10	124
3830-19-4P	7314150428557	1	17,52	124
3830-19-C	7311518225360	1	11,87	124
3830-19-VIP	7311518041649	6	11,87	124
3830-20-4P	7314150428601	1	18,67	124
3830-20-C	7311518225377	1	11,87	124
3830-20-VIP	7311518041656	6	11,87	124
3830-21-C	7311518228361	1	11,87	124
3830-21-VIP	7311518041663	6	11,87	124
3830-210	7311518040666	1	172,27	124
3830-22-4P	7314150428649	1	30,97	124
3830-22-C	7311518225384	1	11,87	124
3830-22-VIP	7311518041670	6	11,87	124
3830-24-C	7311518228378	1	11,87	124
3830-24-VIP	7311518041687	6	11,87	124



3830-25-4P	7314150428663	1	34,13	124
3830-25-C	7311518225391	1	11,99	124
3830-25-VIP	7311518041694	6	11,99	124
3830-27-4P	7314150428670	1	32,45	124
3830-27-C	7311518225407	1	12,63	124
3830-27-VIP	7311518041700	6	12,63	124
3830-29-4P	7314150428922	1	32,72	124
3830-29-C	7311518225414	1	12,63	124
3830-29-VIP	7311518041717	6	12,63	124
3830-30-4P	7314150433483	1	33,00	124
3830-30-C	7311518225421	1	12,63	124
3830-30-VIP	7311518041724	6	12,63	124
3830-32-4P	7314150428687	1	35,04	124
3830-32-C	7311518225438	1	12,63	124
3830-32-VIP	7311518041731	6	12,63	124
3830-33-C	7311518228385	1	12,63	124
3830-33-VIP	7311518041748	6	12,63	124
3830-35-4P	7314150428700	1	35,82	124
3830-35-C	7311518225445	1	14,28	124
3830-35-VIP	7311518041755	6	14,28	124
3830-37-C	7311518228392	1	14,28	124
3830-37-VIP	7311518041762	6	14,28	124
3830-38-C	7311518225452	1	14,28	124
3830-38-VIP	7311518041779	6	14,28	124
3830-40-C	7311518228408	1	14,28	124
3830-40-VIP	7311518041786	6	14,28	124
3830-41-C	7311518225469	1	14,28	124
3830-41-VIP	7311518041793	6	14,28	124
3830-43-C	7311518228415	1	14,28	124
3830-43-VIP	7311518041809	6	14,28	124
3830-44-C	7311518225476	1	16,30	124
3830-44-VIP	7311518041816	6	16,30	124
3830-46-C	7311518228422	1	16,30	124
3830-46-VIP	7311518041823	6	16,30	124
3830-48-C	7311518225483	1	16,30	124
3830-48-VIP	7311518041830	6	16,30	124
3830-50-C	7311518260873	1	16,30	124
3830-50-VIP	7311518260866	6	16,30	124
3830-51-C	7311518225490	1	16,30	124
3830-51-VIP	7311518041847	6	16,30	124
3830-52-C	7311518228439	1	19,70	124
3830-52-VIP	7311518041854	4	19,70	124
3830-54-C	7311518225506	1	19,70	124
3830-54-VIP	7311518041861	4	19,70	124
3830-55-C	7311518270919	1	19,70	124
3830-55-VIP	7311518270902	4	19,70	124
3830-56-C	7311518228446	1	19,70	124
3830-56-VIP	7311518152703	4	19,70	124
3830-57-C	7311518225513	1	19,70	124
3830-57-VIP	7311518041878	4	19,70	124
3830-59-C	7311518228453	1	19,70	124
3830-59-VIP	7311518041885	4	19,70	124
3830-60-C	7311518225520	1	19,70	124
3830-60-VIP	7311518041892	4	19,70	124
3830-62-VIP	73115182234645	4	21,45	124
3830-64-C	7311518225537	1	21,73	124
3830-64-VIP	7311518041908	4	21,73	124
3830-65-C	7311518228460	1	21,73	124
3830-65-VIP	7311518041915	4	21,73	124
3830-67-C	7311518225544	1	21,73	124
3830-67-VIP	7311518041922	4	21,73	124
3830-68-C	7311518228477	1	21,73	124
3830-68-VIP	7311518196530	4	21,73	124
3830-70-C	7311518225551	1	21,73	124
3830-70-VIP	7311518041939	4	21,73	124
3830-73-C	7311518228484	1	21,73	124
3830-73-VIP	7311518041946	4	21,73	124
3830-76-C	7311518225568	1	24,63	124
3830-76-VIP	7311518041953	4	24,63	124
3830-79-C	7311518228491	1	24,63	124
3830-79-VIP	7311518041960	4	24,63	124
3830-83-C	7311518225575	1	24,63	124
3830-83-VIP	7311518041977	4	24,63	124
3830-86-C	7311518228507	1	24,63	124
3830-86-VIP	7311518041984	4	24,63	124
3830-89-C	7311518225582	1	24,63	124
3830-89-VIP	7311518041991	4	24,63	124
3830-92-C	7311518225599	1	28,54	124
3830-92-VIP	7311518042004	4	28,54	124
3830-95-C	7311518225605	1	30,94	124
3830-95-VIP	7311518042011	4	30,94	124
3830-98-C	7311518228514	1	32,34	124
3830-98-VIP	7311518042028	4	32,34	124
3832-102	7311518558567	4	61,07	131
3832-102-C	7314150474394	1	71,54	132
3832-105	7311518558581	4	65,43	131
3832-108	7311518558604	4	76,72	131
3832-111	7311518558611	4	88,73	131
3832-114	7311518558628	4	98,54	131
3832-114-C	7314150474424	1	115,41	132
3832-121	7311518558642	1	109,46	131
3832-127	7311518558666	1	120,37	131
3832-127-C	7314150474431	1	127,79	132
3832-133	7311518558673	1	130,55	131
3832-14	7311518557744			



3832-146	7311518558697	1	148,71	131
3832-152	7311518558703	1	161,80	131
3832-16	7311518557768	6	20,00	131
3832-16-C	7314150474448	1	20,00	132
3832-17	7311518557782	6	20,00	131
3832-19	7311518557805	6	20,00	131
3832-19-C	7314150474455	1	20,00	132
3832-20	7311518557812	6	20,00	131
3832-20-C	7314150474462	1	20,00	132
3832-21	7311518557829	6	20,00	131
3832-22	7311518557843	6	20,00	131
3832-22-C	7314150474479	1	20,00	132
3832-24	7311518557867	6	20,00	131
3832-24-C	7314150479054	1	20,00	132
3832-25	7311518557881	6	21,09	131
3832-25-C	7314150474486	1	21,10	132
3832-27	7311518557904	6	22,54	131
3832-29	7311518557928	6	22,54	131
3832-29-C	7314150474493	1	22,54	132
3832-30	7311518557942	6	22,54	131
3832-30-C	7314150479061	1	22,54	132
3832-32	7311518557966	6	22,54	131
3832-32-C	7314150474509	1	22,54	132
3832-33	7311518557980	6	22,54	131
3832-35	7311518558000	6	25,08	131
3832-35-C	7314150474516	1	25,08	132
3832-37	7311518558024	6	25,08	131
3832-38	7311518558048	6	25,08	131
3832-38-C	7314150474523	1	25,08	132
3832-40	7311518558062	6	25,08	131
3832-41	7311518558086	6	25,08	131
3832-41-C	7314150474530	1	25,08	132
3832-43	7311518558109	6	25,08	131
3832-44	7311518558123	6	29,09	131
3832-44-C	7314150474547	1	29,09	132
3832-46	7311518558147	6	29,09	131
3832-46-C	7314150479078	1	29,09	132
3832-48	7311518558161	6	29,09	131
3832-48-C	7314150474554	1	29,09	132
3832-51	7311518558185	6	29,09	131
3832-51-C	7314150474561	1	29,09	132
3832-52	7311518558208	4	35,28	131
3832-54	7311518558222	4	35,28	131
3832-54-C	7314150474578	1	35,28	132
3832-56	7311518558239	4	35,28	131
3832-57	7311518558246	4	35,28	131
3832-57-C	7314150474585	1	35,28	132
3832-59	7311518558260	4	35,28	131
3832-60	7311518558284	4	35,28	131
3832-60-C	7314150474615	1	35,28	132
3832-64	7311518558307	4	38,90	131
3832-64-C	7314150474622	1	38,91	132
3832-65	7311518558321	4	38,90	131
3832-67	7311518558345	4	38,90	131
3832-68	7311518558352	4	38,90	131
3832-70	7311518558369	4	38,90	131
3832-73	7311518558383	4	38,90	131
3832-73-C	7314150474639	1	38,91	132
3832-76	7311518558406	4	43,28	131
3832-76-C	7314150474646	1	43,28	132
3832-79	7311518558420	4	43,28	131
3832-83	7311518558444	4	43,28	131
3832-83-C	7314150474653	1	43,28	132
3832-86	7311518558468	4	43,28	131
3832-86-C	7314150474660	1	43,28	132
3832-89	7311518558482	4	43,28	131
3832-92	7311518558505	4	50,17	131
3832-92-C	7314150474677	1	50,17	132
3832-95	7311518558529	4	54,91	131
3832-98	7311518558543	4	58,18	131
3832-SET-164-ES	7314150487349	1	383,37	132
3832-SET-84-ES	7314150498932	1	231,75	132
3833-102-C	7314150263899	1	32,10	129
3833-105-C	7314150263905	1	32,40	129
3833-108-C	7314150263912	1	32,54	129
3833-109-C	7314150263929	1	35,44	129
3833-111-C	7314150263936	1	32,78	129
3833-114-C	7314150263943	1	35,52	129
3833-121-C	7314150263950	1	35,96	129
3833-127-C	7314150263967	1	37,91	129
3833-133-C	7314150401581	1	38,82	129
3833-140-C	7314150263974	1	39,44	129
3833-152-C	7314150263981	1	42,41	129
3833-159-C	7314150263998	1	48,61	129
3833-168	7314150413546	1	54,35	129
3833-177	7314150413539	1	58,23	129
3833-19-C	7314150263561	1	13,22	129
3833-20-C	7314150263578	1	13,06	129
3833-210	7314150413522	1	67,54	129
3833-22-C	7314150263585	1	13,19	129
3833-225	7314150413515	1	70,98	129
3833-25-C	7314150263592	1	13,61	129
3833-27-C	7314150263608	1	14,20	129
3833-29-C	7314150263615	1	15,01	129
3833-30-C	7314150263622	1	14,83	129
3833-32-C	7314150263639	1	15,12	129



3833-35-C	7314150263646	1	16,97	129
3833-38-C	7314150263653	1	16,97	129
3833-40-C	7314150263660	1	17,27	129
3833-41-C	7314150263677	1	17,27	129
3833-44-C	7314150263684	1	20,31	129
3833-48-C	7314150263691	1	20,31	129
3833-51-C	7314150263707	1	20,81	129
3833-54-C	7314150263714	1	22,54	129
3833-56-C	7314150314676	1	23,48	129
3833-57-C	7314150263721	1	23,48	129
3833-60-C	7314150263738	1	23,48	129
3833-62-C	7314150314683	1	23,48	129
3833-64-C	7314150263745	1	23,61	129
3833-65-C	7314150263752	1	23,61	129
3833-67-C	7314150263769	1	23,61	129
3833-68-C	7314150263776	1	23,86	129
3833-70-C	7314150263783	1	24,05	129
3833-71-C	7314150314690	1	24,05	129
3833-73-C	7314150263790	1	24,05	129
3833-74-C	7314150314706	1	24,05	129
3833-76-C	7314150263806	1	24,94	129
3833-77-C	7314150263813	1	27,38	129
3833-78-C	7314150314713	1	27,38	129
3833-79-C	7314150263820	1	27,38	129
3833-83-C	7314150263837	1	27,91	129
3833-86-C	7314150263844	1	28,11	129
3833-89-C	7314150263851	1	28,24	129
3833-92-C	7314150263868	1	29,05	129
3833-95-C	7314150263875	1	29,88	129
3833-98-C	7314150263882	1	30,39	129
3833-PROMO-42	7314150464951	1	136,04	129
3833-SET-101	7314150315383	1	311,52	129
3833-SET-201	7314150315406	1	353,86	129
3833-SET-202	7314150315420	1	348,92	129
3833-SET-203	7314150315444	1	348,92	130
3833-SET-204	7314150315468	1	314,44	130
3833-SET-205	7314150330874	1	263,46	130
3833-SET-207	7314150330898	1	353,28	130
3833-SET-208	7314150330904	1	360,52	130
3833-SET-301	7314150315376	1	334,19	130
3833-SET-302	7314150315390	1	218,39	131
3833-SET-303	7314150315413	1	280,43	131
3833-SET-304	7314150315437	1	347,22	131
3834-ADP	7311518454425	1	6,42	134
3834-ARBR-11152	7311518015596	1	24,73	133
3834-ARBR-11152-C	7311518225698	1	25,98	133
3834-ARBR-11152QC	7311518167967	1	21,09	133
3834-ARBR-11152QC-C	7311518225711	1	22,16	133
3834-ARBR-1130	7311518015572	4	13,63	133
3834-ARBR-1130-C	7311518228583	1	14,31	133
3834-ARBR-16152	7311518015602	1	24,73	133
3834-ARBR-16152QC	7311518453152	1	23,11	133
3834-ARBR-630	7311518015558	1	11,81	133
3834-ARBR-630-C	7311518228576	1	12,39	133
3834-ARBR-730	7311518167974	1	9,44	133
3834-ARBR-730-C	7311518225674	1	9,93	133
3834-ARBR-9100	7311518015589	1	24,73	133
3834-ARBR-9100-C	7311518228590	1	25,98	133
3834-ARBR-9100EL	7314150265077	1	42,59	132
3834-ARBR-9100ESM	7314150390458	1	43,25	132
3834-ARBR-9100QC	7311518249830	1	21,09	133
3834-ARBR-9100QC-C	7311518225704	1	22,38	133
3834-ARBR-930	7311518015565	1	11,81	133
3834-ARBR-930-C	7311518225681	1	12,39	133
3834-ARBR-930EL	7314150265053	1	41,86	132
3834-ARBR-930ESM	7314150390465	1	41,26	132
3834-ARBR-SD152QC	7311518203825	1	26,19	133
3834-ARBR-SD30	7311518203818	1	14,54	133
3834-CP-20/25	7314150312092	1	62,88	124
3834-DRL	7311518234638	1	5,65	133
3834-DRL-CT	7311518953201	1	16,38	133
3834-DRL-EL	7314150265114	1	9,40	132
3834-DRL-ES	7314150265091	1	9,01	133
3834-DRL-HSS-ES	7314150339396	1	15,88	133
3834-DRL-L	7314150265138	1	9,14	133
3834-ES	7311518454418	1	2,14	133
3834-EXT-1	7311518040673	1	20,80	133
3834-EXT-2	7311518168070	1	20,80	133
3834-M6X29-SET	7314150383450	1	2,67	134
3834-M8X10-SET	7314150383429	1	1,88	134
3834-M8X5-SET	7314150383443	1	1,67	134
3834-M8X6-SET	7314150383436	1	1,77	134
3834-PROMO-122	7314150432059	1	110,00	125
3834-PROMO-122-76	7314150459193	1	120,08	125
3834-PROMO-82	7314150432042	1	91,19	125
3834-SET-103	7314150134908	1	144,11	128
3834-SET-152	7314150255658	1	256,76	128
3834-SET-42	7311518241988	1	149,90	125
3834-SET-53	7314150127153	1	218,37	125
3834-SET-61	7311518266431	1	183,16	126
3834-SET-62	7311518228040	1	122,46	126
3834-SET-62-16/50	7311518258887	1	117,04	126
3834-SET-65-16/51	7311518159900	1	136,54	126
3834-SET-65-22/64	7311518159917	1	151,95	126
3834-SET-72	7311518044992	1	163,24	126
3834-SET-72-35/83	7314150444229	1	125,18	125



3834-SET-73



3834-SET-73	7311518254339	1	202,95	127
3834-SET-73-22/68	7314150134809	1	151,43	127
3834-SET-77	7314150235919	1	200,30	127
3834-SET-84-ES	7314150470587	1	122,61	127
3834-SET-86	7311518224295	1	268,80	127
3834-SET-87	7311518181772	1	187,87	127
3834-SET-92	7311518044985	1	187,88	128
3834-SET-93	7314150414741	1	163,11	128
3834-SET-94	7311518166458	1	174,23	128
3834-SET-95	7311518159894	1	184,21	128
3834-UPSIZO	7314150344567	1	4,43	133
3835-SET-64	7314150423309	1	252,92	132
3835-SET-711	7314150465835	1	265,55	132
384-5T	7311518159795	4	18,81	630
384-6T	7311518002039	4	18,81	630
3845-18-10P	7311518101602	1	40,61	135
3845-24-10P	7311518101619	1	40,61	135
3845-32-10P	7311518101626	1	40,61	135
385-6T	7311518002053	4	19,98	630
3851-10-0.6-10/14	7311518182717	1	8,98	12
3851-10-0.6-H-4	7311518282776	1	8,98	12
3851-10-0.6-H-6	7311518282806	1	8,98	12
3851-10-0.6-HA-4	7314150139309	1	8,98	12
3851-10-0.9-10/14	7311518182823	1	8,98	12
3851-10-0.9-H-4	7311518282851	1	8,98	12
3851-10-0.9-H-6	7311518282868	1	8,98	12
3851-10-0.9-R-14	7314150312399	1	8,98	12
3851-13-0.5-10/14	7311518282813	1	8,98	12
3851-13-0.5-14/18	7311518282790	1	8,98	12
3851-13-0.5-H-4	7311518292072	1	8,98	12
3851-13-0.5-R-10	7311518331306	1	8,98	12
3851-13-0.5-R-14	7311518331320	1	8,98	12
3851-13-0.5-R-18	7311518331344	1	8,98	12
3851-13-0.5-R-24	7311518282820	1	8,98	12
3851-13-0.6-10/14	7311518183271	1	8,98	12
3851-13-0.6-5/8	7311518183233	1	8,98	12
3851-13-0.6-6/10	7311518183240	1	8,98	12
3851-13-0.6-8/12	7311518185572	1	8,98	12
3851-13-0.6-H-3	7311518282769	1	8,98	12
3851-13-0.6-H-4	7311518282745	1	8,98	12
3851-13-0.6-H-6	7311518282738	1	8,98	12
3851-13-0.6-HA-4	7311518282752	1	8,98	12
3851-13-0.6-HA-6	7311518282561	1	8,98	12
3851-13-0.6-R-10	7311518183110	1	8,98	12
3851-13-0.6-R-14	7311518183158	1	8,98	12
3851-13-0.6-R-18	7311518183196	1	8,98	12
3851-13-0.9-10/14	7311518183868	1	8,98	12
3851-13-0.9-6/10	7311518183585	1	8,98	12
3851-13-0.9-H-3	7311518282936	1	8,98	12
3851-13-0.9-H-4	7311518282943	1	8,98	12
3851-13-0.9-H-6	7311518286125	1	8,98	12
3851-13-0.9-HA-4	7311518281052	1	8,98	12
3851-13-0.9-R-14	7311518182359	1	8,98	12
3851-13-0.9-R-6	7311518183301	1	8,98	12
3851-20-0.9-10/14	7311518282585	1	9,15	12
3851-20-0.9-4/6	7311518183905	1	9,15	12
3851-20-0.9-5/8	7311518183929	1	9,15	12
3851-20-0.9-6/10	7311518183936	1	9,15	12
3851-20-0.9-8/12	7311518282578	1	9,15	12
3851-20-0.9-H-3	7314150398515	1	9,15	12
3851-20-0.9-H-4	7314150398294	1	9,15	12
3851-20-0.9-HA-3	7311518282646	1	9,15	12
3851-20-0.9-HA-4	7311518282653	1	9,15	12
3851-20-0.9-R-18	7311518332587	1	9,15	12
3851-27-0.9-10/14	7311518165475	1	9,30	13
3851-27-0.9-2/3	7311518126377	1	9,30	13
3851-27-0.9-3/4	7311518126384	1	9,30	13
3851-27-0.9-4/6	7311518126391	1	9,30	13
3851-27-0.9-5/8	7311518126407	1	9,30	13
3851-27-0.9-6/10	7311518126414	1	9,30	13
3851-27-0.9-8/12	7311518160692	1	9,30	13
3851-27-0.9-HA-3	7311518282684	1	9,30	12
3851-27-0.9-HA-4	7314150398317	1	9,30	12
3851-27-0.9-P-3	7311518157135	1	9,30	12
3851-27-0.9-P-4	7311518157661	1	9,30	12
3851-27-0.9-R-6	7311518126353	1	9,30	12
3851-34-1.1-2/3	7311518126476	1	13,67	13
3851-34-1.1-3/4	7311518126483	1	13,67	13
3851-34-1.1-4/6	7311518126490	1	13,67	13
3851-34-1.1-5/8	7311518126506	1	13,67	13
3851-34-1.1-6/10	7311518165505	1	13,67	13
3851-34-1.1-P-2	7311518157715	1	13,67	12
3851-34-1.1-P-3	7311518157753	1	13,67	12
3851-41-1.3-1.4/2	7311518211837	1	17,71	13
3851-41-1.3-2/3	7311518126568	1	17,71	13
3851-41-1.3-3/4	7311518126575	1	17,71	13
3851-41-1.3-4/6	7311518126582	1	17,71	13
3851-41-1.3-5/8	7311518262488	1	17,71	13
3851-54-1.3-1.4/2	7314150459360	1	20,23	13
3851-54-1.3-2/3	7311518163716	1	20,25	13
3851-54-1.3-3/4	7311518163723	1	22,73	13
3851-54-1.3-4/6	7311518168025	1	20,25	13
3851-54-1.6-1.4/2	7311518211431	1	20,25	13
3851-54-1.6-1/1.4	7311518188542	1	20,25	13
3851-54-1.6-2/3	7311518126636	1	20,25	13
3851-54-1.6-3/4	7311518126643	1	20,25	13



3851-54-1.6-4/6	7314150398539	1	20,25	13
3851-54-1.6-P-1.25	7311518158026	1	20,25	13
3851-6-0.6-10/14	7311518180652	1	8,66	12
3851-6-0.6-H-6	7311518282707	1	8,66	12
3851-6-0.9-10/14	7311518180768	1	8,66	12
3851-6-0.9-H-6	7311518282714	1	8,66	12
3851-67-1.6-7/1	7311518200909	1	35,08	13
3851-67-1.6-1.4/2	7314150273317	1	35,08	13
3851-67-1.6-1/1.4	7311518178840	1	35,08	13
3851-67-1.6-2/3	7311518335243	1	35,08	13
3851-67-1.6-3/4	7311518328597	1	35,08	13
3851-67-1.6-4/6	7311518194963	1	35,08	13
3851-80-1.6-7/1	7311518255367	1	52,69	13
3851-80-1.6-1.4/2	7311518255350	1	52,69	13
3851-80-1.6-1/1.4	7311518197377	1	52,69	13
3852-27-0.9-INS-3	7311518358204	1	13,39	17
3852-34-1.1-INS-3	7311518359188	1	14,42	17
3853-20-0.9-5/7-VS	7311518331689	1	10,04	14
3853-20-0.9-8/11-VS	7311518331702	1	10,04	14
3853-27-0.9-3/4	7311518285395	1	10,43	14
3853-27-0.9-4/6	7311518183998	1	10,43	14
3853-27-0.9-5/7-VS	7311518331115	1	10,43	14
3853-27-0.9-5/8	7311518202118	1	10,43	14
3853-27-0.9-8/11-VS	7311518331122	1	10,43	14
3853-34-1.1-2/3	7311518282875	1	12,91	14
3853-34-1.1-3/4	7311518184094	1	12,91	14
3853-34-1.1-4/6	7311518184087	1	12,91	14
3853-34-1.1-5/7-VS	7311518331726	1	12,91	14
3853-34-1.1-5/8	7311518202149	1	12,91	14
3853-34-1.1-8/11-VS	7311518331719	1	12,91	14
3853-41-1.3-2/3	7311518282882	1	20,00	14
3853-41-1.3-2/3-W	7314150370115	1	20,00	14
3853-41-1.3-2/3-WS	7314150415113	1	51,85	14
3853-41-1.3-3/4	7311518185770	1	20,00	14
3853-41-1.3-3/4-W	7311518338053	1	20,00	14
3853-41-1.3-3/4-WS	7314150415120	1	48,87	14
3853-41-1.3-4/6	7311518184100	1	20,00	14
3853-41-1.3-5/7-VS	7311518331733	1	20,00	14
3853-41-1.3-5/8	7311518202286	1	20,00	14
3853-54-1.3-3/4	7311518184124	1	24,56	14
3853-54-1.3-3/4-W	7314150352876	1	24,56	14
3853-54-1.3-5/8	7311518197568	1	24,56	14
3853-54-1.6-2/3	7311518282899	1	24,56	14
3853-54-1.6-2/3-W	7311518338077	1	24,56	14
3853-54-1.6-2/3-WS	7314150415151	1	57,14	14
3853-54-1.6-3/4	7311518216757	1	24,56	14
3853-54-1.6-3/4-W	7311518338091	1	24,56	14
3853-54-1.6-3/4-WS	7314150415168	1	53,47	14
3853-54-1.6-4/6	7311518222055	1	24,56	14
3853-67-1.6-2/3	7311518282905	1	34,90	14
3853-67-1.6-2/3-W	7311518338114	1	34,90	14
3853-67-1.6-2/3-WS	7314150415175	1	63,70	14
3853-67-1.6-3/4	7311518282912	1	34,90	14
3853-67-1.6-3/4-W	7311518338138	1	34,90	14
3853-67-1.6-3/4-WS	7314150415182	1	62,01	14
3853-67-1.6-5/8-W	7311518338152	1	34,90	14
3854-27-0.9-PHX-2/3	7314150440603	1	10,45	13
3854-27-0.9-PHX-3/4	7314150440610	1	10,45	13
3854-27-0.9-PHX-4/6	7314150440627	1	10,45	13
3854-27-0.9-PQ-3/4	7314150137480	1	14,57	13
3854-27-0.9-PQ-4/6	7314150197828	1	14,57	13
3854-34-1.1-PHX-1.4/2	7314150440634	1	14,63	13
3854-34-1.1-PHX-2/3	7314150440641	1	14,63	13
3854-34-1.1-PHX-3/4	7314150440658	1	14,63	13
3854-34-1.1-PHX-4/6	7314150440665	1	14,63	13
3854-34-1.1-PQ-2/3	7311518287276	1	16,59	13
3854-34-1.1-PQ-3/4	7314150135813	1	16,59	13
3854-34-1.1-PQ-4/6	7314150197835	1	16,59	13
3854-41-1.3-PHX-1.4/2	7314150440672	1	18,95	13
3854-41-1.3-PHX-2/3	7314150440689	1	18,95	13
3854-41-1.3-PHX-3/4	7314150440696	1	18,95	13
3854-41-1.3-PHX-4/6	7314150440702	1	18,95	13
3854-41-1.3-PQ-1.4/2	7314150129355	1	19,75	13
3854-41-1.3-PQ-2/3	7311518280604	1	19,75	13
3854-41-1.3-PQ-3/4	7311518282950	1	19,75	13
3854-41-1.3-PQ-4/6	7314150197842	1	19,75	13
3854-54-1.3-PHX-1.4/2	7314150440719	1	26,39	13
3854-54-1.3-PHX-2/3	7314150440730	1	26,39	13
3854-54-1.3-PHX-3/4	7314150440740	1	26,39	13
3854-54-1.6-PHX-7/1	7314150440757	1	29,89	13
3854-54-1.6-PHX-1.4/2	7314150440771	1	29,89	13
3854-54-1.6-PHX-1/1.4	7314150440764	1	29,89	13
3854-54-1.6-PHX-2/3	7314150440788	1	29,89	13
3854-54-1.6-PHX-3/4	7314150440795	1	29,89	13
3854-54-1.6-PQ-9/1.2	7314150133857	1	30,14	13
3854-54-1.6-PQ-1.4/2	7314150127092	1	30,14	13
3854-54-1.6-PQ-2/3	7311518265137	1	30,14	13
3854-54-1.6-PQ-3/4	7311518282929	1	30,14	13
3854-54-1.6-PQ-4/6				

			€	
3854-80-1.6-PHX-7/1	7314150440849	1	56,38	13
3854-80-1.6-PHX-1.4/2	7314150440863	1	56,38	13
3854-80-1.6-PHX-1/1.4	7314150440856	1	56,38	13
3854-80-1.6-PQ-9/1.2	7314150133895	1	57,86	13
3854-80-1.6-PQ-1.4/2	7314150215966	1	56,38	13
3857-13-0.6-EZ-L	7311518264789	1	9,81	12
3857-13-0.6-EZ-M	7311518264772	1	9,81	12
3857-13-0.6-EZ-M-3P1140	7314150321100	1	27,79	143
3857-13-0.6-EZ-M-3P690	7314150325641	1	27,79	143
3857-13-0.6-EZ-M-3P730	7314150325658	1	27,79	143
3857-13-0.6-EZ-M-3P835	7314150325665	1	27,79	143
3857-13-0.6-EZ-M-3P900	7314150321094	1	27,79	143
3857-13-0.6-EZ-S	7311518264765	1	9,81	12
3857-13-0.6-EZ-S-3P1140	7314150345731	1	27,79	143
3857-13-0.6-EZ-S-3P690	7314150345694	1	27,79	143
3857-13-0.6-EZ-S-3P730	7314150345700	1	27,79	143
3857-13-0.6-EZ-S-3P835	7314150345717	1	27,79	143
3857-13-0.6-EZ-S-3P900	7314150345724	1	27,79	143
3857-20-0.9-EZ-L	7311518264819	1	10,91	12
3857-20-0.9-EZ-M	7311518264802	1	10,91	12
3857-20-0.9-EZ-S	7311518264796	1	10,91	12
3857-27-0.9-EZ-L	7311518264840	1	12,43	12
3857-27-0.9-EZ-M	7311518264833	1	12,43	12
3857-27-0.9-EZ-S	7311518264826	1	12,43	12
3857-34-1.1-EZ-L	7311518264871	1	15,26	12
3857-34-1.1-EZ-M	7311518264864	1	15,26	12
3857-34-1.1-EZ-S	7311518264857	1	15,26	12
3858-34-1.1-PHX-1.4/2	7314150441198	1	15,50	14
3858-34-1.1-PHX-2/3	7314150441204	1	15,50	14
3858-34-1.1-PHX-3/4	7314150441211	1	15,50	14
3858-41-1.3-PHX-1.4/2	7314150441013	1	20,75	14
3858-41-1.3-PHX-2/3	7314150441020	1	20,75	14
3858-41-1.3-PHX-3/4	7314150441037	1	20,75	14
3858-41-1.3-PQ-1.4/2	7314150395583	1	25,63	14
3858-41-1.3-PQ-2/3	7314150395590	1	25,63	14
3858-41-1.3-PQ-3/4	7314150395606	1	25,63	14
3858-54-1.3-PHX-1.4/2	7314150441068	1	26,85	14
3858-54-1.3-PHX-2/3	7314150441044	1	26,85	14
3858-54-1.3-PHX-3/4	7314150441051	1	26,85	14
3858-54-1.6-PHX-7/1	7314150441075	1	26,85	14
3858-54-1.6-PHX-1.4/2	7314150441099	1	26,85	14
3858-54-1.6-PHX-1/1.4	7314150441082	1	26,85	14
3858-54-1.6-PHX-2/3	7314150441105	1	26,85	14
3858-54-1.6-PHX-3/4	7314150441112	1	26,85	14
3858-54-1.6-PQ-9/1.2	7314150395613	1	39,06	14
3858-54-1.6-PQ-1.4/2	7314150395620	1	39,06	14
3858-54-1.6-PQ-2/3	7314150395637	1	39,06	14
3858-67-1.6-PHX-7/1	7314150441129	1	36,62	14
3858-67-1.6-PHX-1.4/2	7314150441143	1	36,62	14
3858-67-1.6-PHX-1/1.4	7314150441136	1	36,62	14
3858-67-1.6-PHX-2/3	7314150441150	1	36,62	14
3858-67-1.6-PQ-9/1.2	7314150395644	1	51,26	14
3858-67-1.6-PQ-1.4/2	7314150395651	1	51,26	14
3858-80-1.6-PHX-7/1	7314150441167	1	43,21	14
3858-80-1.6-PHX-1.4/2	7314150441181	1	43,21	14
3858-80-1.6-PHX-1/1.4	7314150441174	1	43,21	14
3858-80-1.6-PQ-9/1.2	7314150395668	1	73,24	14
3859-27-0.9-EZX-3/4	7314150517558	1	32,14	15
3859-27-0.9-EZX-4/6	7314150517565	1	42,02	15
3859-34-1.1-EZX-2/3	7314150517572	1	31,72	15
3859-34-1.1-EZX-3/4	7314150517589	1	40,38	15
3859-34-1.1-EZX-4/6	7314150517596	1	43,67	15
3859-41-1.3-EZX-1.4/2	7314150517602	1	30,39	15
3859-41-1.3-EZX-2/3	7314150517619	1	34,30	15
3859-41-1.3-EZX-3/4	7314150517626	1	44,19	15
3859-41-1.3-EZX-4/6	7314150517633	1	46,25	15
3859-54-1.6-EZX-1.4/2	7314150517640	1	43,16	15
3859-54-1.6-EZX-1/1.25	7314150517657	1	39,24	15
3859-54-1.6-EZX-2/3	7314150517664	1	44,70	15
3859-54-1.6-EZX-3/4	7314150517671	1	48,00	15
3859-54-1.6-EZX-4/6	7314150517688	1	56,75	15
3859-67-1.6-EZX-7/1	7314150517695	1	39,45	15
3859-67-1.6-EZX-1.4/2	7314150517701	1	46,66	15
3859-67-1.6-EZX-1/1.25	7314150517718	1	42,75	15
3859-67-1.6-EZX-2/3	7314150517725	1	57,17	15
3859-80-1.6-EZX-7/1	7314150517732	1	41,51	15
3859-80-1.6-EZX-1.4/2	7314150517749	1	49,23	15
3859-80-1.6-EZX-1/1.25	7314150517756	1	77,25	15
386-6T	7311518152017	4	21,15	630
3860-100-1.1-TMC-1.4/2	7314150336968	1	116,93	16
3860-27-0.9-TCD-3	7314150413010	1	96,46	16
3860-27-0.9-TCD-3/4	7314150413027	1	91,44	16
3860-27-0.9-TCD-3/4	7314150263493	1	89,46	16
3860-34-1.1-TCD-2/3	7314150413034	1	70,73	16
3860-34-1.1-TCD-3/4	7314150413041	1	100,96	16
3860-34-1.1-TCD-3/4-W	7314150413058	1	100,96	16
3860-34-1.1-TCD-3/4	7311518330880	1	70,76	16
3860-34-1.1-TCD-3/4	7311518330897	1	100,95	16
3860-41-1.3-TCD-1.4/2	7314150413065	1	63,92	16
3860-41-1.3-TCD-1.9/2.1	7314150413072	1	68,50	16
3860-41-1.3-TCD-2/3	7314150413089	1	71,35	16
3860-41-1.3-TCD-3/4	7314150413096	1	106,61	16
3860-41-1.3-TCD-3/4	7311518330903	1	69,66	16
3860-41-1.3-TCD-3/4	7311518330910	1	106,61	16
3860-41-1.3-TMC-1.4/2	7314150129379	1	97,11	16
3860-41-1.3-TMC-2/3	7311518330224	1	113,62	16

			€	
3860-54-1.3-TMC-1.4/2	7314150288748	1	114,97	16
3860-54-1.3-TMC-2/3	7311518335267	1	133,05	16
3860-54-1.6-TCD-1.4/2	7314150413119	1	81,39	16
3860-54-1.6-TCD-1.9/2.1	7314150413133	1	66,41	16
3860-54-1.6-TCD-2/3	7314150413140	1	97,71	16
3860-54-1.6-TCD-3/4	7314150413157	1	135,68	16
3860-54-1.6-TMC-7/1	7314150263431	1	90,00	16
3860-54-1.6-TMC-1.4/2	7314150137978	1	106,82	16
3860-54-1.6-TMC-1.4/2S	7314150395316	1	118,67	17
3860-54-1.6-TMC-1/1.25	7314150154340	1	114,11	16
3860-54-1.6-TMC-1/1.25S	7314150395309	1	115,28	17
3860-54-1.6-TMC-2/3	7314150189366	1	146,66	16
3860-54-1.6-TMC-2/3S	7314150395323	1	129,97	17
3860-67-1.6-TCD-1.4/2	7314150413164	1	87,03	16
3860-67-1.6-TCD-1/1.25	7314150413171	1	61,43	16
3860-67-1.6-TMC-1.4/2	7314150137985	1	121,39	16
3860-67-1.6-TMC-1.4/2S	7314150395347	1	129,97	17
3860-67-1.6-TMC-1/1.25	7314150154364	1	126,24	16
3860-67-1.6-TMC-1/1.25S	7314150395330	1	124,32	17
3860-67-1.6-TMC-2/3	7314150189359	1	149,72	16
3860-80-1.1-TMC-1.4/2	7314150382767	1	113,27	16
3860-80-1.6-TCD-5/0.8	7314150413188	1	93,86	16
3860-80-1.6-TMC-7/1	7314150154371	1	135,96	16
3860-80-1.6-TMC-1.4/2	7314150182992	1	149,31	16
3860-80-1.6-TMC-1/1.25	7314150182336	1	142,62	16
3860-80-1.6-TMC-2/3	7314150215959	1	151,11	16
3861-20-0.6-H-4	7311518331351	1	2,88	17
3861-27-0.9-H-1.33	7311518329716	1	3,83	17
3861-34-0.9-H-1.15	7311518258894	1	8,72	17
3861-34-1.1-H-1.15	7311518258900	1	8,72	17
3861-41-1.1-H-1.15	7314150129294	1	11,57	17
3861-54-1.1-H-1.15	7314150129270	1	13,08	17
3862-33-0.9-H-1.15	7314150320325	1	14,12	17
3862-33-1.1-H-1.15	7311518331269	1	14,12	17
3862-40-1.1-H-1.15	7311518331283	1	15,09	17
3868-27-0.9-TSS-3/4	7314150447633	1	87,49	15
3868-27-0.9-TSX-3/4	7311518329693	1	87,49	15
3868-34-1.1-TSS-2/3	7311518329266	1	71,21	15
3868-34-1.1-TSS-3/4	7314150447640	1	8,81	15
3868-34-1.1-TSX-2	7311518203016	1	57,33	15
3868-34-1.1-TSX-2/3	7311518255343	1	69,82	15
3868-34-1.1-TSX-3/4	7311518232375	1	86,09	15
3868-41-1.3-TSS-1.4/2	7311518243142	1	77,62	15
3868-41-1.3-TSS-2/3	7311518270643	1	76,80	15
3868-41-1.3-TSX-1.4/2	7311518214210	1	70,50	15
3868-41-1.3-TSX-1.6	7311518203092	1	61,27	15
3868-41-1.3-TSX-2	7311518203085	1	60,20	15
3868-41-1.3-TSX-2/3	7311518232382	1	74,87	15
3868-41-1.3-TSX-3/4	7311518232399	1	92,13	15
3868-54-1.3-TSX-1.4/2	7311518214876	1	91,48	15
3868-54-1.3-TSX-2/3	7314150416394	1	93,01	15
3868-54-1.6-TSS-1.4/2	7311518243166	1	111,95	15
3868-54-1.6-TSS-1/1.25	7311518243173	1	113,99	15
3868-54-1.6-TSS-2/3	7311518280383	1	118,10	15
3868-54-1.6-TSX-1.4/2	7311518214869	1	101,86	15
3868-54-1.6-TSX-1.6	7311518203108	1	88,57	15
3868-54-1.6-TSX-1/1.25	7311518213114	1	93,16	15
3868-54-1.6-TSX-2/3	7311518232405	1	93,28	15
3868-54-1.6-TSX-3/4	7311518270360	1	93,28	15
3868-67-1.6-TSS-7/1	7311518274115	1	122,43	15
3868-67-1.6-TSS-1.4/2	7311518243197	1	130,30	15
3868-67-1.6-TSS-1/1.25	7311518243180	1	130,30	15
3868-67-1.6-TSS-2/3	7311518328825	1	130,30	15
3868-67-1.6-TSX-7/1	7311518212865	1	122,43	15
3868-67-1.6-TSX-1.4/2	7311518265496	1	130,30	15
3868-67-1.6-TSX-1/1.25	7311518213084	1	127,43	15
3868-67-1.6-TSX-2/3	7314150203536	1	130,30	15
3868-80-1.1-TSX-3/4	7311518330200	1	205,05	15
3868-80-1.6-TSS-7/1	7314150216253	1	130,30	15
3868-80-1.6-TSS-1.4/2	7314150203529	1	156,23	15
3868-80-1.6-TSS-2/3	7314150398553	1	180,64	15
3868-80-1.6-TSX-7/1	7311518212872	1	130,30	15
3868-80-1.6-TSX-1.4/2	7314150342167	1	129,40	15
3868-80-1.6-TSX-1/1.25	7314150277278	1	139,15	15
3868-80-1.6-TSX-2/3	7314150203543	1	180,64	15
3869-13-0.9-TS-3	7311518200589	1	53,99	15
3869-20-0.9-TS-3	7311518177300	1	55,83	15
3869-20-0.9-TS-4	7311518197742	1	81,45	15
3869-27-0.9-TS-3	7311518177348	1	55,83	15
3869-27-0.9-TS-4	7311518182595	1	81,45	15
3869-34-1.1-TS-2	7314150330508	1	35	

3875-GLOVE



Table with 5 columns: Product Name, Code, Quantity, Price, and Unit. Lists various glove models like 3875-GLOVE, 3875-HB10, etc.



Table with 5 columns: Product Name, Code, Quantity, Price, and Unit. Lists various glove models like 3911-180-T42-M, 3911-180TT41-M, etc.

BAHCO



3940-150-24-ST-5P	7314150364381	5	17,70	134
3940-150-4/6-SC-10P	7314150361847	1	33,73	135
3940-150-4/6-SC-2P	7314150361823	10	9,27	135
3940-150-4/6-SC-5P	7314150361830	5	17,70	135
3940-150-5/8-DSL-10P	7314150361991	1	35,30	135
3940-150-5/8-DSL-2P	7314150361977	5	10,73	135
3940-150-5/8-DSL-5P	7314150361984	5	18,54	135
3940-150-5/8-SL-100P	7314150361724	1	319,99	135
3940-150-5/8-SL-10P	7314150361717	1	33,73	135
3940-150-5/8-SL-2P	7314150361687	10	9,27	135
3940-150-5/8-SL-5P	7314150361700	5	17,70	135
3940-150-6-ST-10P	7314150361786	1	33,73	135
3940-150-6-ST-2P	7314150361762	10	9,27	135
3940-150-6-ST-5P	7314150361779	5	17,70	135
3940-150-8/12-ST-100P	7314150362158	1	319,99	134
3940-150-8/12-ST-10P	7314150362141	1	33,73	134
3940-150-8/12-ST-2P	7314150362127	10	7,08	134
3940-150-8/12-ST-5P	7314150362134	5	17,70	134
3940-228-10-DSL-100P	7314150362035	1	609,48	135
3940-228-10-DSL-10P	7314150362028	1	60,94	135
3940-228-10-DSL-2P	7314150362004	10	13,52	135
3940-228-10-DSL-5P	7314150362011	5	33,78	135
3940-228-10-HST-100P	7314150362417	1	625,49	134
3940-228-10-HST-10P	7314150362400	1	46,04	134
3940-228-10-HST-2P	7314150362387	10	9,18	134
3940-228-10-HST-5P	7314150362394	5	24,98	134
3940-228-10-PRO9-100P	7314150361625	1	414,29	135
3940-228-10-ST-100P	7314150362110	1	412,60	134
3940-228-10-ST-10P	7314150362103	1	43,32	134
3940-228-10-ST-2P	7314150362080	10	12,78	134
3940-228-10-ST-5P	7314150362097	5	22,95	134
3940-228-10/14-PRO9-100P	7314150361526	1	311,77	135
3940-228-10/14-PRO9-10P	7314150361519	1	31,19	135
3940-228-10/14-PR13-100P	7314150361649	1	429,06	135
3940-228-10/14-PR13-10P	7314150451265	1	42,90	135
3940-228-14-HST-10P	7314150362226	1	47,02	134
3940-228-14-HST-2P	7314150362202	10	10,23	134
3940-228-14-HST-5P	7314150362219	5	25,60	134
3940-228-14-ST-100P	7314150364145	1	412,60	134
3940-228-14-ST-10P	7314150364138	1	43,32	134
3940-228-14-ST-2P	7314150364114	5	9,18	134
3940-228-14-ST-5P	7314150364121	5	22,95	134
3940-228-18-HST-10P	7314150362271	1	50,40	134
3940-228-18-HST-2P	7314150362233	10	10,08	134
3940-228-18-HST-5P	7314150362264	5	25,19	134
3940-228-18-ST-100P	7314150364220	1	412,60	134
3940-228-18-ST-10P	7314150364213	1	43,32	134
3940-228-18-ST-2P	7314150364190	10	9,18	134
3940-228-18-ST-5P	7314150364206	5	22,95	134
3940-228-5/8-DSL-10P	7314150361939	1	45,68	135
3940-228-5/8-DSL-2P	7314150361915	10	10,73	135
3940-228-5/8-DSL-5P	7314150361922	5	23,87	135
3940-228-6-SL-10P	7314150361755	1	43,32	135
3940-228-6-SL-2P	7314150361731	10	10,73	135
3940-228-6-SL-5P	7314150361748	5	22,95	135
3940-228-8/12-PR13-100P	7314150361601	1	396,67	135
3940-228-8/12-ST-100P	7314150362073	1	412,60	134
3940-228-8/12-ST-10P	7314150362066	1	43,32	134
3940-228-8/12-ST-2P	7314150362042	5	9,18	134
3940-228-8/12-ST-5P	7314150362059	5	22,95	134
3940-300-10-HST-10P	7314150362448	1	54,04	134
3940-300-10-HST-2P	7314150362424	10	12,13	134
3940-300-10-HST-5P	7314150362431	5	30,35	134
3940-300-14-HST-10P	7314150362301	1	54,04	134
3940-300-14-HST-2P	7314150362288	10	12,18	134
3940-300-14-HST-5P	7314150362295	5	30,43	134
3940-300-14-ST-100P	7314150364268	1	513,43	134
3940-300-14-ST-10P	7314150364251	1	54,01	134
3940-300-14-ST-2P	7314150364237	5	11,31	134
3940-300-14-ST-5P	7314150364244	5	28,29	134
3940-300-18-HST-10P	7314150364008	1	52,96	134
3940-300-18-HST-2P	7314150363988	10	11,97	134
3940-300-18-HST-5P	7314150363995	5	29,96	134
3940-300-18-ST-100P	7314150364305	1	512,41	134
3940-300-18-ST-10P	7314150364299	1	54,01	134
3940-300-18-ST-2P	7314150364275	10	11,31	134
3940-300-18-ST-5P	7314150364282	5	28,29	134
3940-300-5/8-DSL-10P	7314150361960	1	56,69	135
3940-300-5/8-DSL-2P	7314150361946	10	11,91	135
3940-300-5/8-DSL-5P	7314150361953	5	29,73	135
3940-300-6-SL-10P	7314150361816	1	54,01	135
3940-300-6-SL-2P	7314150361793	10	10,73	135
3940-300-6-SL-5P	7314150361809	5	28,29	135
3940-300-8/12-SL-100P	7314150361908	1	502,13	135
3940-300-8/12-SL-10P	7314150361892	1	54,01	135
3940-300-8/12-SL-2P	7314150361878	5	10,73	135
3940-300-8/12-SL-5P	7314150361885	5	28,29	135
3940-HDD-SET-5P	7314150401703	5	33,52	137
3940-METAL-SET-12P	7314150511488	6	52,80	137
3940-METAL-SET-5P	7314150401673	5	22,00	137
3940-MIX-SET-10P	7314150401666	4	45,04	137
3940-MIX-SET-12P	7314150511501	6	54,04	137
3940-MIX-SET-5P	7314150401659	5	25,13	137
3942-150-7-SL-10P	7314150364534	1	35,80	136
3942-150-7-SL-2P	7314150364510	10	19,24	136
3942-150-7-SL-5P	7314150364527	5	19,24	136



3942-228-11-HSL-10P	7314150364831	1	30,84	136
3942-228-11-HSL-2P	7314150364817	10	8,74	136
3942-228-11-HSL-5P	7314150364824	5	18,44	136
3942-228-5-HSL-10P	7314150364657	1	46,05	136
3942-228-5-HSL-2P	7314150364633	10	12,26	136
3942-228-5-HSL-5P	7314150364640	5	25,00	136
3942-228-7-HSL-10P	7314150364749	1	43,32	136
3942-228-7-HSL-2P	7314150364725	10	12,05	136
3942-228-7-HSL-5P	7314150364732	5	23,46	136
3942-228-7-SL-10P	7314150364503	1	43,52	136
3942-228-7-SL-2P	7314150364480	10	9,31	136
3942-228-7-SL-5P	7314150364497	5	23,27	136
3942-300-5-HSL-10P	7314150364688	1	51,73	136
3942-300-5-HSL-2P	7314150364664	10	15,26	136
3942-300-5-HSL-5P	7314150364671	5	29,71	136
3942-300-7-HSL-10P	7314150364770	1	49,61	136
3942-300-7-HSL-2P	7314150364756	10	20,17	136
3942-300-7-HSL-5P	7314150364763	5	26,64	136
3942-300-7-SL-10P	7314150364619	1	48,20	136
3942-300-7-SL-2P	7314150364596	10	14,54	136
3942-300-7-SL-5P	7314150364602	5	27,94	136
3942-WOOD-SET-12P	7314150511525	6	70,40	137
3942-WOOD-SET-5P	7314150401680	5	29,33	137
3943-C30-JT-F	7314150422869	10	19,12	136
3943-C30-JT-M	7314150422876	10	19,12	136
3943-C35-JT-C	7314150422937	10	20,70	136
3943-C35-JT-M	7314150422883	10	21,37	136
3943-R28-UT-C-2P	7314150422951	10	16,87	137
3943-S20-JT-F	7314150422944	10	15,75	136
3944-300-3-MEAT-1P	7314150364862	10	11,43	138
3946-100-DG-ST-2P	7314150478644	10	9,13	135
3946-150-10-HST-1P	7314150478156	10	9,13	135
3946-150-6-DSL-1P	7314150478101	10	9,13	136
3946-150-6-SL-1P	7314150364916	5	24,50	138
3946-150-8-HST-1P	7314150478132	10	22,25	135
3946-150-DG-ST-2P	7314150478668	10	15,97	135
3946-228-10-HST-1P	7314150478255	10	35,38	135
3946-228-3-ST-1P	7314150364886	5	23,87	138
3946-228-6-DSL-1P	7314150478217	10	28,24	136
3946-228-8-HST-1P	7314150478231	10	30,81	135
3946-300-10-HST-1P	7314150478323	10	47,92	135
3946-300-2-CB-1P	7314150478354	10	34,23	138
3946-300-6-DSL-1P	7314150478286	10	31,95	136
3946-300-8-HST-10P	7314150539741	1	370,80	135
3946-300-8-HST-1P	7314150478309	10	39,82	135
3946-457-2-CB-1P	7314150478738	10	45,64	138
396-BLADE	7311518299057	100	15,88	634
396-BLADE-1P	7311518330613	1	14,52	634
396-HP	7311518152284	4	19,98	635
396-HP-BLADE	7311518156404	300	12,92	636
396-INS	7314150422708	10	25,96	561
396-JS	7311518223250	4	23,50	634
396-JS-BLADE	7311518223267	300	21,15	635
396-JT	7311518168056	4	23,50	635
396-JT-BLADE	7311518168063	300	21,15	636
396-LAP	7311518172367	10	38,44	634
4-138-06-1-0	7311518020927	10	7,60	27
4-138-06-1-2	7311518000592	5	10,79	27
4-138-08-1-0	7311518020934	10	9,78	27
4-138-08-1-2	7311518000615	5	13,01	27
4-138-10-1-0	7311518020958	10	12,04	27
4-138-10-1-2	7311518000646	5	15,09	27
4-138-12-1-0	7311518020965	5	16,82	27
4-138-12-1-2	7311518194734	5	19,48	27
4-140-06-1-0	7311518020989	10	7,95	27
4-140-08-1-0	7311518020996	10	9,92	27
4-140-08-1-2	7311518028169	5	13,01	27
4-140-10-1-2	7311518022488	10	12,18	27
4-140-10-1-2	7311518194741	5	15,34	27
4-142-06-1-0	7311518021016	10	7,33	27
4-142-08-1-0	7311518021023	10	8,48	27
4-142-10-1-0	7311518021030	10	11,09	27
4-144-08-2-0	7311518021054	10	10,25	28
4-144-08-2-2	7311518201319	5	13,39	28
4-152-08-2-2	7311518000691	5	16,44	28
4-153-08-1-2	7311518000707	5	16,44	28
4-154-08-2-2	7311518000714	10	31,18	28
4-155-08-2-0	7311518116194	10	12,22	28
4-155-10-2-0	7311518116200	5	16,18	28
4-183-04-2-0	7311518021108	10	4,40	28
4-183-04-2-2	7311518201401	5	6,19	28
4-183-05-2-0	7311518021122	10	5,09	28
4-183-05-2-2	7311518201418	5	7,59	28
4-183-06-2-0	7311518021139	10	6,06	28
4-183-06-2-2	7311518000769	5	7,78	28
4-183-07-2-0	7311518021146	10		



4-186-07-2-0	7311518021238	10	7,27	28
4-186-08-2-0	7311518021245	10	8,21	28
4-187-04-2-0	7311518021269	10	5,43	29
4-187-05-2-0	7311518021283	10	5,86	29
4-187-05-2-2	7311518201449	5	7,93	29
4-187-06-2-0	7311518021290	10	6,20	29
4-187-06-2-2	7311518022464	5	9,47	29
4-187-07-2-0	7311518021306	10	8,83	29
4-187-45-2-0	7311518021276	10	5,86	29
4-188-05-2-0	7311518021337	10	7,12	29
4-188-05-2-2	7311518201456	5	9,10	29
4-188-06-2-0	7311518021344	10	7,95	29
4-190-06-2-2	7311518000899	5	7,80	29
4-190-07-2-0	7311518021375	10	7,19	29
4-190-07-2-2	7311518000905	5	9,38	29
4-190-08-2-0	7311518021382	10	7,68	29
4-190-08-2-2	7311518000912	5	8,66	29
4-192-06-2-0	7311518021412	10	8,41	29
4-192-06-2-2	7311518201463	5	11,64	29
4-192-07-2-0	7311518021429	10	9,58	29
4-192-08-2-0	7311518021436	10	10,25	29
4-192-08-2-2	7311518201487	5	13,39	29
4-202-85-2-0	7311518021474	10	10,47	30
4-204-85-2-0	7311518021498	10	13,35	30
4-272-05-3-2	7311518201500	5	11,64	30
4-272-06-3-0	7311518021597	10	8,48	30
4-272-06-3-2	7311518001025	5	11,64	30
400.002.050	7314150249848	1	494,20	609
400.003.020	8412814403205	1	87,06	609
400.003.030	8412814403304	1	214,41	609
401-16	7314150400270	12	31,08	268
401-28	7314150384082	12	31,08	268
402-15-95	7314150485604	1	9,45	269
402-35	7314150384099	6	55,83	268
402-76	7314150384105	6	114,20	268
402-95-SET	7314150400997	1	36,79	269
4020L-M-3.2	7314151405038	5	19,59	43
4020L-M-3.5	7314151077709	5	19,59	43
4020L-M-4	7314151077716	5	18,50	43
4020L-M-4.5	7314151077723	5	18,50	43
4020L-M-5	7314151077730	5	18,50	43
4020L-M-5.5	7314151077747	5	18,50	43
4040M-10-11	7314151078287	1	40,76	59
4040M-10-13	7314153000750	1	45,27	59
4040M-12-13	7314151078294	1	42,45	59
4040M-13-17	7314151804565	1	44,25	59
4040M-14-15	7314151078300	1	44,50	59
4040M-16-17	7314151078317	1	48,56	59
4040M-16-18	7314151839635	1	50,02	59
4040M-18-19	7314151078324	1	55,34	59
4040M-20-22	7314151078331	1	65,74	59
4040M-21-23	7314151078348	1	68,49	59
4040M-6-7	7314151831967	1	38,95	59
4040M-8-9	7314151078270	1	39,89	59
4040M/6T	7314150112197	1	267,07	59
4040M/S6	7314150112180	1	283,48	59
4040Z-1/2-9/16	7314151831998	1	43,70	59
4040Z-13/16-7/8	7314150355099	1	57,12	59
4040Z-3/8-7/16	7314151831981	1	39,35	59
4040Z-5/8-11/16	7314151832001	1	46,58	59
4040Z-5/8-3/4	7314153001023	1	49,72	59
405-1000	7314150399758	5	60,82	540
405-1000-M	7314150399765	5	64,59	540
405-400	7314150399673	5	29,76	540
405-400-M	7314150399680	5	33,53	540
405-600	7314150399697	5	35,59	540
405-600-M	7314150399703	5	39,47	540
405-800	7314150399710	10	45,29	540
405-800-M	7314150399741	5	49,06	540
405L-400	7314150400461	10	27,18	540
405L-400-M	7314150400492	5	30,41	540
405L-600	7314150400478	10	33,01	540
405L-600-M	7314150400485	5	36,89	540
406-300	7314150183678	1	35,56	540
406-300-M	7314150183658	5	48,86	540
406-400	7314150183685	5	40,29	540
406-400-M	7314150183838	5	53,72	540
406-500	7314150183692	5	48,61	540
406-500-M	7314150186365	5	58,90	540
406-600	7314150245819	5	47,65	540
406-600-M	7314150245840	5	57,74	540
406-800	7314150245826	5	56,36	540
406P-400	7314150302574	10	10,20	540
406P-600	7314150302581	10	12,91	540
406T-225	7314150315130	10	6,80	541
407-1000	7314150369928	6	17,11	595
407-1400	7314150373703	6	19,13	595
407-700	7314150369911	5	15,41	595
407F-1000	7314150383801	6	19,76	595
407F-1400	7314150383818	6	22,56	595
407F-700	7314150383795	6	17,91	595
40B-115-165	7314153011879	25	60,81	60
40B-115-165-SP	7314153024459	1	4,27	60
40B-150-230	7314153024534	10	61,83	60
40B-19-50	7314153011848	25	24,23	60
40B-19-50-SP	7314153024473	1	3,61	60



40B-32-75	7314153011855	25	35,47	60
40B-32-75-SP	7314153024497	1	3,61	60
40B-50-120	7314153011862	20	44,73	60
40B-50-120-SP	7314153024510	1	4,27	60
4106-115-165	7314153024572	25	39,42	60
4106-150-230	7314153024596	10	88,11	60
4106-19-50	7314153011886	10	27,36	60
4106-32-75	7314153011893	25	39,88	60
4106-50-120	7314153024558	25	40,80	60
411-26	7314150412068	4	45,63	270
411-26-95	7314150412259	50	16,94	270
411-35	7314150412082	4	59,69	270
411-35-95	7314150412266	50	26,56	270
411-42	7314150412112	6	78,27	270
411-42-95	7314150412273	50	31,40	270
411-63	7314150412136	5	115,15	270
411-63-95	7314150412280	30	59,39	270
412-26-MULTI	7314150412174	5	85,57	270
412-26-MULTI-95	7314150412303	150	20,32	270
412-28-PEX	7314150412150	5	58,51	270
412-28-PEX-95	7314150412297	30	20,22	270
4124-JT-H	7311518267803	4	23,50	635
4128-JT-H	7311518267810	4	28,21	635
4130	7314150100019	3	47,87	233
413005000	8413345011860	12	63,78	598
413010000	8413345011877	12	105,08	598
413015000	8413345011884	12	138,00	598
413020000	8413345011891	6	180,83	598
413030000	8413345119986	1	183,55	598
413040000	8413345119993	1	243,68	598
4131	7314150100026	3	47,87	233
414-10	7311518238148	4	15,42	571
414-12	7311518238155	4	16,44	571
414-14	7311518238162	4	16,77	571
414-15	7311518238179	4	16,91	571
414-16	7311518238186	4	17,10	571
414-18	7311518238193	4	17,56	571
414-20	7311518238209	4	17,89	571
414-22	7311518238216	4	18,35	571
414-25	7311518238223	4	18,84	571
414-28	7311518238230	4	19,48	571
414-30	7311518238247	4	19,79	571
414-32	7311518238254	4	20,12	571
414-35	7311518238261	4	20,75	571
414-38	7311518238278	4	21,23	571
414-6	7311518238117	4	15,25	571
414-8	7311518238131	4	15,60	571
414-S3-EUR	7311518249205	1	52,83	571
416-1000	7314150314027	10	26,69	540
416-1200	7314150308798	10	30,26	540
416-1500	7314150314034	10	34,20	540
416-1800	7314150308804	10	39,77	540
416-2000	7314150308811	10	47,38	540
416-400	7314150314003	10	15,97	540
416-600	7314150308781	10	18,73	540
416-800	7314150314010	10	21,60	540
416-SET-1	7314150308828	5	68,26	541
416-SET-2	7314150308835	5	71,12	541
416-SET+BAG	7314150365470	1	101,07	540
41RM-10	7314153014429	1	24,04	45
41RM-11	7314153014436	1	25,27	45
41RM-12	7314153014443	1	27,28	45
41RM-13	7314153014450	1	28,07	45
41RM-14	7314153014467	1	29,43	45
41RM-17	7314153014474	1	33,27	45
41RM-19	7314153014481	1	37,59	45
41RM-21	7314150219742	1	39,20	45
41RM-8	7314153014412	1	22,07	45
41RM/SH8	7314150220656	10	234,58	46
41RZ-1/2	7314150359011	1	23,68	45
41RZ-11/16	7314150359042	1	30,08	45
41RZ-13/16	7314150359066	1	45,30	45
41RZ-3/4	7314150359059	1	31,32	45
41RZ-3/8	7314150358991	1	20,95	45
41RZ-5/16	7314150358984	1	19,80	45
41RZ-5/8	7314150359035	1	28,08	45
41RZ-7/16	7314150359004	1	21,66	45
41RZ-7/8	7314150359073	1	45,30	45
41RZ-9/16	7314150359028	1	25,01	45
420SC-25	7314150169825	10	5,72	589
420SC-50	7314150169832	5	8,53	589
420SH-100-200	7314150359691	10	36,97	588
420SH-120-1000	7314150359790	6	67,07	588
420SH-120-1250	7314150359806	6	76,20	588
420SH-120-1500	7314150359813	6	79,99	588
420SH-120-250	7314150359707	8	43,82	588
420SH-120-300	7314150359745	8	47,56	588
420SH-120-400	7314150359752	6	49,95	588
420SH-120-500	7314150359769	6	53,32	588
420SH-120-600	7314150359776	6	57,64	588
420SH-120-800	7314150359783	6	63,41	588
420SH-140-400	7314150359820	6	63,41	588
420SH-175-400	7314150359837	6	67,62	588
420SH-50-100	7314150359646	10	14,47	588
420SH-50-200	7314150359653	10	16,02	588
420SH-60-120	7314150359660	12	23,74	588



420SH-60-300	7314150359677	12	28,29	588
420SH-80-160	7314150359684	12	31,47	588
4211-11-6T	7311518152000	4	17,63	635
4211-14-6T	7311518128883	4	19,98	635
4212-11-6T	7311518002060	4	17,63	635
4212-14-6T	7311518002077	4	19,98	635
422P-10	7311518248369	4	36,86	572
422P-12	7311518248376	4	36,86	572
422P-16	7311518248383	4	36,86	572
422P-20	7311518248390	4	39,06	572
422P-25	7311518248406	4	46,40	572
422P-6	7311518248352	4	36,41	572
4231	7314150100033	3	65,81	235
4239	7314150100088	3	64,54	235
424P-10	7311518238315	4	19,10	570
424P-12	7311518238322	4	19,55	570
424P-14	7311518238339	4	20,01	570
424P-15	7311518238346	4	20,22	570
424P-16	7311518238353	4	20,46	570
424P-18	7311518238360	4	20,91	570
424P-20	7311518238377	4	21,36	570
424P-22	7311518238384	4	21,80	570
424P-24	7311518238391	4	22,26	570
424P-25	7311518238407	4	22,46	570
424P-26	7311518238414	4	22,71	570
424P-28	7311518238421	4	23,17	570
424P-30	7311518238438	4	23,62	570
424P-32	7311518238445	4	24,06	570
424P-35	7311518238452	4	24,74	570
424P-38	7311518238469	4	25,42	570
424P-4	7311518238285	4	17,75	570
424P-40	7311518238476	4	25,87	570
424P-6	7311518238292	4	18,20	570
424P-8	7311518238308	4	18,65	570
424P-S3-EUR	7311518249199	1	62,95	570
424P-S6-EUR	7311518269968	1	144,69	571
424P-S6-GER	7311518280086	1	134,56	571
424P-S6-LR	7314150423804	1	137,66	570
424P-S6-PP	7314150326662	1	97,98	571
424P-S8-EUR	7311518276393	1	197,31	571
425-081	7311518010669	1	47,95	572
425-082	7311518010676	1	76,39	572
425-083	7311518010683	1	100,87	572
425-10	7311518004613	4	14,54	572
425-12	7311518004620	4	14,89	572
425-14	7311518004637	4	15,23	572
425-15	7311518017767	4	15,41	572
425-16	7311518004644	4	15,58	572
425-18	7311518004651	4	15,94	572
425-20	7311518004668	4	16,27	572
425-22	7311518004675	4	16,60	572
425-24	7311518005993	4	16,97	572
425-25	7311518004682	4	17,13	572
425-26	7311518006006	4	17,30	572
425-28	7311518004699	4	17,64	572
425-30	7311518004705	4	18,01	572
425-32	7311518004712	4	18,32	572
425-35	7311518017774	4	18,86	572
425-38	7311518004729	4	19,40	572
425-4	7311518030810	4	13,51	572
425-40	7311518017781	4	19,69	572
425-6	7311518004590	4	14,01	572
425-8	7311518004606	4	14,21	572
426-1000	7311518004309	1	47,26	539
426-1200	7311518004316	1	55,59	539
426-400	7311518004255	1	31,61	539
426-600	7311518004279	1	35,65	539
426-800	7311518004293	1	39,82	539
426TOR9	7314150125319	10	23,03	541
427-13	7314150403578	4	21,09	592
427-16	7311518025410	4	29,09	592
427-20	7311518025427	4	30,08	592
427-24	7314150402878	4	32,60	592
427-700	7314150338092	6	24,02	592
427-8	7314150402854	4	19,15	592
427S-16	7314150404247	4	22,45	592
427S-20	7314150404261	4	24,76	592
428-16	7311518012380	4	27,36	592
428-700	7314150338108	6	31,10	593
428F-13	7314150436392	4	27,52	592
428F-16	7314150436408	4	30,65	592
428F-20	7314150436422	4	32,62	592
428F-24	7314150436439	4	44,67	592
428F-8	7314150436378	4	24,74	592
428S-16	7314150424030	4	30,65	592
428S-20	7314150424047	4	32,62	592
429-13	7311518012250	4	26,85	592
429-16	7311518012403	4	29,27	592
429-20	7311518012410	4	30,12	592
429-8	7311518040703	4	18,45	592
42RMS/12	7314150384785	1	342,97	46
4307	7314151079444	1	76,55	60
4310	7314151079451	1	103,45	60
434-10	7311518238506	4	23,94	570
434-12	7311518238513	4	24,51	570
434-14	7311518238520	4	25,08	570



434-15	7311518238537	4	25,34	570
434-16	7311518238544	4	25,77	570
434-18	7311518238551	4	26,19	570
434-20	7311518238568	4	26,73	570
434-22	7311518238575	4	27,43	570
434-25	7311518238582	4	28,13	570
434-28	7311518238599	4	29,14	570
434-30	7311518238605	4	29,56	570
434-32	7311518238612	4	30,12	570
434-35	7311518238629	4	30,94	570
434-38	7311518238636	4	31,93	570
434-50	7311518285388	4	36,65	570
434-6	7311518238483	4	22,84	570
434-8	7311518238490	4	23,56	570
434-S3-EUR	7311518249212	1	78,84	570
434-S6-EUR	7311518267544	1	156,01	570
434-S6-LR	7314150423811	1	175,73	570
434-S6-PP	7314150326655	1	158,05	570
434-S8-EUR	7311518295110	1	178,18	570
439000000	8413345129282	1	12,76	473
439000001	7314150268788	1	12,91	473
439000002	7314150309702	1	20,51	473
439000003	7314150309719	1	23,42	473
439000004	7314150427666	1	7,11	473
4400-11	7311518200596	10	11,45	636
4400-11-BULK	7311518200633	10	9,99	636
4400-14	7311518200602	10	12,92	636
4400-14-BULK	7311518200640	10	11,16	636
440102500	8413345098977	10	6,03	595
440103000	8413345098991	10	6,34	595
4411-1.00	7314150372744	1	4,72	151
4411-1.50	7314150372768	1	4,40	151
4411-10.00	7314150372973	1	9,54	151
4411-10.20	7314150372980	1	13,52	151
4411-10.50	7314150470488	1	14,17	151
4411-11.00	7314150372997	1	14,87	151
4411-11.50	7314150470495	1	16,95	151
4411-12.00	7314150373000	1	19,07	151
4411-12.50	7314150470501	1	21,38	151
4411-13.00	7314150373017	1	23,78	151
4411-2.00	7314150372775	1	4,61	151
4411-2.50	7314150372782	1	4,14	151
4411-3.00	7314150372799	1	3,98	151
4411-3.25	7314150372805	1	4,82	151
4411-3.30	7314150372812	1	4,82	151
4411-3.50	7314150372829	1	4,72	151
4411-4.00	7314150372836	1	5,14	151
4411-4.20	7314150372843	1	2,83	151
4411-4.25	7314150372850	1	2,83	151
4411-4.50	7314150372867	1	2,93	151
4411-5.00	7314150372874	1	3,04	151
4411-5.50	7314150372881	1	3,82	151
4411-6.00	7314150372898	1	3,98	151
4411-6.50	7314150372904	1	4,72	151
4411-6.80	7314150372911	1	4,51	151
4411-7.00	7314150372928	1	5,14	151
4411-7.50	7314150372935	1	5,56	151
4411-8.00	7314150372942	1	6,49	151
4411-8.50	7314150372959	1	6,81	151
4411-9.00	7314150372966	1	8,59	151
4411-9.50	7314150394463	1	8,70	151
4413-1.00	7314150371754	1	3,45	152
4413-1.50	7314150371761	1	2,73	152
4413-10.00	7314150372034	1	5,95	152
4413-10.20	7314150372041	1	7,64	152
4413-10.50	7314150470556	25	7,95	152
4413-11.00	7314150372058	1	8,75	152
4413-11.50	7314150470563	25	9,48	152
4413-12.00	7314150372065	1	10,34	152
4413-12.50	7314150470570	25	11,28	152
4413-13.00	7314150372072	1	11,83	152
4413-2.00	7314150371785	1	2,73	152
4413-2.50	7314150371792	1	2,73	152
4413-3.00	7314150371815	1	2,77	152
4413-3.25	7314150371822	1	2,77	152
4413-3.30	7314150371877	1	2,77	152
4413-3.50	7314150371884	1	2,77	152
4413-4.00	7314150371891	1	2,97	152
4413-4.20	7314150371907	1	1,85	152
4413-4.25	7314150371914	1	1,85	152
4413-4.50	7314150371921	1	1,95	152
4413-5.00	7314150371938	1	2,11	152
4413-5.50	7314150371945	1	2,90	152
4413-6.00	7314150371952	1	2,90	152
4413-6.50	7314150371969	1	3,39	152
4413-6.80	7314150371976	1	3,82	152
4413-7.00	7314150371983	1	3,98	152
4413-7.50	7314150371990	1	4,27	152
4413-8.00	7314150372003	1	4,54	152
4413-8.50	7314150372010	1	4,93	152
4413-9.00	7314150372027	1	6,27	152
4413-9.50	7314150394456	1	5,82	152
4415-1.00	7314150394210	1	0,91	153
4415-1.50	7314150394227	1	0,91	153
4415-10.00	7314150394401	1	2,21	153
4415-10.50	7314150470525	1	2,40	153





4415-11.00	7314150394418	1	2,93	153
4415-11.50	7314150470532	1	3,15	153
4415-12.00	7314150394425	1	3,46	153
4415-12.50	7314150470549	1	3,68	153
4415-13.00	7314150394432	1	3,88	153
4415-13.50	7314150441495	1	5,18	153
4415-14.00	7314150441501	1	5,55	153
4415-14.50	7314150441518	1	6,28	153
4415-15.00	7314150441525	1	6,78	153
4415-15.50	7314150441532	1	7,52	153
4415-16.00	7314150441549	1	8,06	153
4415-16.50	7314150441556	1	8,61	153
4415-17.00	7314150441563	1	9,11	153
4415-17.50	7314150441570	1	10,06	153
4415-18.00	7314150441587	1	10,41	153
4415-18.50	7314150441594	1	11,33	153
4415-19.00	7314150441600	1	11,83	153
4415-19.50	7314150441617	1	12,31	153
4415-2.00	7314150394234	1	0,91	153
4415-2.50	7314150394241	1	0,91	153
4415-20.00	7314150441624	1	12,93	153
4415-3.00	7314150394258	1	0,91	153
4415-3.25	7314150394265	1	1,04	153
4415-3.50	7314150394272	1	1,12	153
4415-4.00	7314150394289	1	1,12	153
4415-4.25	7314150394296	1	0,76	153
4415-4.50	7314150394302	1	0,83	153
4415-5.00	7314150394319	1	0,83	153
4415-5.50	7314150394326	1	0,91	153
4415-6.00	7314150394333	1	0,95	153
4415-6.50	7314150394340	1	1,04	153
4415-7.00	7314150394357	1	1,12	153
4415-7.50	7314150394364	1	1,31	153
4415-8.00	7314150394371	1	1,58	153
4415-8.50	7314150394388	1	1,78	153
4415-9.00	7314150394395	1	1,88	153
442	7311518002848	10	14,10	548
442 B	7314150008957	1	67,87	266
442-3P	7314150309610	10	22,85	548
4420-11	7311518200619	10	11,45	636
4420-11-BULK	7311518200657	10	9,99	636
4420-14	7311518200626	10	12,92	636
4420-14-BULK	7311518200664	10	11,16	636
443 B	7314150008971	1	80,23	266
4430	7314150100040	3	41,08	245
4435-12.4	7314150465163	1	7,61	154
444 B	7314150009008	1	107,96	266
4480/2-ZD	7311518276911	1	155,68	271
4480IM	7314150263165	1	59,70	271
4480MM	7314150263158	1	59,70	271
449	7311518005337	10	13,30	548
44Z-1/2-9/16	7314150375233	10	33,89	53
44Z-1/4-5/16	7314150375196	10	21,36	53
44Z-11/16-13/16	7314150375264	5	52,62	53
44Z-11/16-3/4	7314150375257	5	41,94	53
44Z-3/8-7/16	7314150375219	10	24,61	53
44Z-5/16-3/8	7314150375202	10	21,36	53
44Z-5/8-3/4	7314150375240	5	41,94	53
44Z-7/16-1/2	7314150375226	10	28,55	53
451	7311518014506	10	15,52	548
4511-0.50-10P	7314150373079	1	26,60	151
4511-0.75-10P	7314150373062	1	24,04	151
4511-1.00-10P	7314150373055	1	19,48	151
4511-1.50-10P	7314150373086	1	18,55	151
4511-1.75-10P	7314150373093	1	23,25	151
4511-10.00-5P	7314150373444	1	44,53	151
4511-10.20-5P	7314150373468	1	62,85	151
4511-10.30-5P	7314150373475	1	74,89	151
4511-10.50-5P	7314150373482	1	63,05	151
4511-10.80-5P	7314150373499	1	87,15	151
4511-11.00-5P	7314150373505	1	69,66	151
4511-11.50-5P	7314150373512	1	83,28	151
4511-12.00-5P	7314150373529	1	89,25	151
4511-12.50-5P	7314150373536	1	108,67	151
4511-12.80-5P	7314150373543	1	124,12	151
4511-13.00-5P	7314150373550	1	111,03	151
4511-13.50-1P	7314150373567	1	24,51	151
4511-14.00-1P	7314150373574	1	24,20	151
4511-14.50-1P	7314150373581	1	34,36	151
4511-15.00-1P	7314150373598	1	34,89	151
4511-15.50-1P	7314150373604	1	40,43	151
4511-16.00-1P	7314150373611	1	41,80	151
4511-16.50-1P	7314150373628	1	47,76	151
4511-17.00-1P	7314150373635	1	47,76	151
4511-17.50-1P	7314150373642	1	53,00	151
4511-18.00-1P	7314150373659	1	57,72	151
4511-18.50-1P	7314150373673	1	63,68	151
4511-19.00-1P	7314150373680	1	63,80	151
4511-19.50-1P	7314150373697	1	70,71	151
4511-2.00-10P	7314150373109	1	19,48	151
4511-2.50-10P	7314150373116	1	17,70	151
4511-2.70-10P	7314150373123	1	21,94	151
4511-2.90-10P	7314150373130	1	21,94	151
4511-20.00-1P	7314150373666	1	75,74	151
4511-3.00-10P	7314150373147	1	17,29	151
4511-3.10-10P	7314150373185	1	21,15	151



4511-3.25-10P	7314150373192	1	21,15	151
4511-3.30-10P	7314150373208	1	21,15	151
4511-3.50-10P	7314150373215	1	21,15	151
4511-3.80-10P	7314150373222	1	26,60	151
4511-4.00-10P	7314150373239	1	22,42	151
4511-4.20-10P	7314150373246	1	24,93	151
4511-4.50-10P	7314150373253	1	25,13	151
4511-4.80-10P	7314150373260	1	29,54	151
4511-5.00-10P	7314150373277	1	26,60	151
4511-5.20-10P	7314150373284	1	32,16	151
4511-5.50-10P	7314150373291	1	33,73	151
4511-6.00-10P	7314150373307	1	35,82	151
4511-6.20-10P	7314150373314	1	44,83	151
4511-6.50-10P	7314150373321	1	43,05	151
4511-6.80-10P	7314150373338	1	50,18	151
4511-7.00-10P	7314150373345	1	47,24	151
4511-7.20-10P	7314150373352	1	68,34	151
4511-7.50-10P	7314150373369	1	50,18	151
4511-7.80-10P	7314150373376	1	82,23	151
4511-8.00-10P	7314150373383	1	59,07	151
4511-8.50-10P	7314150373390	1	61,17	151
4511-8.60-10P	7314150373406	1	100,04	151
4511-8.80-10P	7314150373413	1	100,04	151
4511-9.00-10P	7314150373420	1	78,56	151
4511-9.20-10P	7314150373437	1	110,93	151
4511-9.50-10P	7311518339081	1	81,18	151
4511-9.60-10P	7314150373451	1	130,41	151
4511-SET-19	7314150373031	1	82,65	151
4511-SET-25	7314150373048	1	193,77	152
4511-SET-6	7314150373024	1	20,33	151
4513-1.00-10P	7314150372119	1	17,29	152
4513-1.50-10P	7314150372126	1	12,89	152
4513-1.75-10P	7314150372133	1	14,35	152
4513-10.00-5P	7314150391998	1	30,13	152
4513-10.20-5P	7314150392001	1	37,90	152
4513-10.30-5P	7314150392018	1	48,06	152
4513-10.50-5P	7314150392025	1	39,43	152
4513-10.80-5P	7314150392032	1	59,28	152
4513-11.00-5P	7314150392049	1	43,07	152
4513-11.50-5P	7314150392056	1	47,13	152
4513-12.00-5P	7314150392063	1	51,45	152
4513-12.50-5P	7314150392070	1	56,31	152
4513-12.80-5P	7314150392087	1	98,58	152
4513-13.00-5P	7314150392094	1	58,84	152
4513-13.50-1P	7314150392100	1	20,32	152
4513-14.00-1P	7314150392117	1	21,87	152
4513-14.50-1P	7314150392124	1	23,46	152
4513-15.00-1P	7314150392131	1	23,76	152
4513-15.50-1P	7314150392148	1	27,15	152
4513-16.00-1P	7314150392155	1	28,94	152
4513-16.50-1P	7314150392162	1	32,01	152
4513-17.00-1P	7314150392179	1	32,01	152
4513-17.50-1P	7314150392186	1	36,84	152
4513-18.00-1P	7314150392193	1	38,97	152
4513-18.50-1P	7314150392200	1	43,24	152
4513-19.00-1P	7314150392216	1	43,24	152
4513-19.50-1P	7314150392223	1	46,39	152
4513-2.00-10P	7314150372140	1	12,15	152
4513-2.50-10P	7314150372157	1	12,47	152
4513-2.70-10P	7314150372164	1	15,09	152
4513-2.90-10P	7314150372171	1	15,09	152
4513-20.00-1P	7314150392230	1	52,79	152
4513-3.00-10P	7314150372188	1	11,00	152
4513-3.10-10P	7314150372195	1	12,89	152
4513-3.25-10P	7314150372201	1	12,89	152
4513-3.30-10P	7314150372218	1	12,89	152
4513-3.50-10P	7314150372225	1	12,89	152
4513-3.80-10P	7314150372232	1	18,33	152
4513-4.00-10P	7314150372249	1	16,34	152
4513-4.20-10P	7314150372256	1	18,02	152
4513-4.50-10P	7314150372263	1	18,85	152
4513-4.80-10P	7314150372270	1	20,64	152
4513-5.00-10P	7314150372287	1	20,69	152
4513-5.20-10P	7314150372294	1	23,05	152
4513-5.50-10P	7314150372300	1	26,81	152
4513-6.00-10P	7314150372317	1	27,65	152
4513-6.20-10P	7314150372324	1	31,42	152
4513-6.50-10P	7314150372331	1	32,26	152
4513-6.80-10P	7314150372348	1	36,87	152
4513-7.00-10P	7314150372355	1	38,97	152
4513-7.20-10P	7314150372362	1	49,23	152
4513-7.50-10P	7314150372379	1	41,48	152
4513-7.80-10P	7314150372386	1	60,26	152
4513-8.00-10P	7314150372393	1	46,93	152
4513-8.50-10P	7314150372409	1	51,11	152
4513-8.60-10P	7314150372416	1	80,96	152
4513-8.80-10P	7314150372423	1	82,68	152
4513-9.00-10P	7314150372430	1	62,00	152
4513-9.20-10P	7314150372447	1	84,04	152
4513-9.50-10P	7314150372454	1	59,76	152
4513-9.60-10P	7314150372461	1	95,01	152
4513-SET-19	7314150372096	1	57,11	152
4513-SET-25	7314150372102	1	121,82	153
4513-SET-6	7314150372089	1	15,89	152
4515-1.00-10P	7314150441228	1	3,66	153
4515-1.50-10P	7314150441235	1</		

			€	
4515-10.00-10P	7314150441426	1	23,05	153
4515-10.50-5P	7314150441433	1	12,70	153
4515-11.00-5P	7314150441440	1	14,82	153
4515-11.50-5P	7314150441457	1	15,77	153
4515-12.00-5P	7314150441464	1	16,23	153
4515-12.50-5P	7314150441471	1	17,38	153
4515-13.00-5P	7314150441488	1	18,53	153
4515-2.00-10P	7314150441242	1	3,66	153
4515-2.50-10P	7314150441259	1	3,66	153
4515-3.00-10P	7314150441266	1	3,66	153
4515-3.25-10P	7314150441273	1	5,03	153
4515-3.50-10P	7314150441280	1	5,48	153
4515-4.00-10P	7314150441297	1	5,48	153
4515-4.25-10P	7314150441303	1	6,77	153
4515-4.50-10P	7314150441310	1	6,77	153
4515-5.00-10P	7314150441327	1	7,25	153
4515-5.50-10P	7314150441334	1	8,22	153
4515-6.00-10P	7314150441341	1	8,70	153
4515-6.50-10P	7314150441358	1	9,18	153
4515-7.00-10P	7314150441365	1	12,70	153
4515-7.50-10P	7314150441372	1	14,01	153
4515-8.00-10P	7314150441389	1	14,99	153
4515-8.50-10P	7314150441396	1	18,33	153
4515-9.00-10P	7314150441402	1	20,58	153
4515-9.50-10P	7314150441419	1	22,86	153
4515-SET-19	7314150394449	1	22,62	153
4515-SET-25	7314150441709	1	44,21	153
4518-3	7314151716547	1	254,45	367
4518-4	7314151716622	1	310,89	367
4518-5	7314151716899	1	321,49	367
4519-1	7314151716974	1	270,35	366
4519-1/S	7314151843762	1	61,51	365
4519-2	7314151717193	1	354,97	366
4519-3	7314151717278	1	405,06	366
4521N-0	7314151837723	1	75,62	367
4521N-00	7314151837716	1	75,63	367
4521N-A	7314151837730	1	72,08	367
4521N-B	7314151837747	1	72,08	367
4521N-C	7314151837754	1	74,31	367
4521N-D	7314151837761	1	74,31	367
4521N-E	7314151837778	1	74,31	367
4521N-F	7314151837785	1	84,52	367
4521N-G	7314151837792	1	84,52	367
4521N-H	7314151837808	1	86,95	367
4521N-I	7314151837815	1	96,55	367
4521N-K	7314151837822	1	118,97	367
4521N-L	7314151837839	1	118,97	367
4521N-M	7314151837846	1	148,43	367
4521N-S	7314151839789	1	356,01	367
4521N-T	7314151839796	1	424,78	367
4521N/7	7314151839802	1	1.196,54	367
4522-1	7314151081591	1	64,56	367
4522-2	7314151081614	1	102,02	367
4523G	7314151846695	1	76,44	367
4524G	7314151718596	1	108,61	367
4528-1	7314151718671	1	1.168,83	365
4528M1	7314151718916	1	123,96	365
4528M2	7314151719050	1	220,66	365
4528M3	7314151719135	1	328,83	365
4528M4	7314151719210	1	397,08	365
4528M5	7314151719487	1	407,22	365
4529-15	7314151719647	1	267,36	364
4529-8	7314151719562	1	222,01	364
4530	7314150100095	3	43,35	246
4532-0	7314151719722	1	122,51	364
4532-A	7314151082109	1	108,82	364
4532-AL	7314150221912	1	116,99	364
4532-B	7314151082116	1	113,69	364
4532-BL	7314150221929	1	123,93	364
4532-C	7314151082123	1	188,42	364
4532-CD/S	7314151818067	1	49,89	364
4532-CL	7314150221936	1	208,03	364
4532-D	7314151082130	1	194,89	364
4532-E	7314151082147	1	304,40	364
4532-EFG/S	7314151838386	1	89,23	364
4532-F	7314151082154	1	337,81	364
4532-G	7314151082161	1	564,50	364
4532-G-SO	7314151841003	1	653,40	364
4532-H	7314151719999	1	1.033,37	364
4532-H/S	7314151838393	1	139,82	364
4532-OAB/S	7314151818050	1	26,35	364
4532K1	7314151082185	1	58,88	364
4532K2	7314151082192	1	99,65	364
4532K3	7314151082208	1	165,43	364
4532K4	7314151720148	1	289,57	364
4532LK1	7314151082215	1	79,59	364
4532LK2	7314151082222	1	133,04	364
4532LK3	7314151082239	1	223,02	364
4532LK4	7314151082246	1	267,75	364
4532LK5	7314151720223	1	280,38	364
4532ST/5	7314151720490	1	920,85	364
4533HP	7314151793043	1	2.711,70	364
4533HP/S	7314150224487	1	585,90	364
4533HPK	7314150224500	1	638,91	364
4533M	7314151793050	1	2.474,61	364
4533M/S	7314150224494	1	194,70	364

			€	
4533MK	7314150224517	1	459,36	364
4537-1	7314151720650	1	98,05	365
4537-2	7314151720735	1	175,44	365
4537-3	7314151720810	1	253,81	365
4537-4	7314151721039	1	299,04	365
4540-17	7314150125005	1	258,62	366
4540-17/S	7314150225248	1	39,50	366
4540-25	7314150125012	1	382,24	366
4540-25/S	7314150225286	1	49,35	366
4541-A	7314151082413	1	109,87	365
4541-B	7314151082420	1	184,42	365
4542-A	7314151082451	1	142,07	365
4542-B	7314151082468	1	234,86	365
4543-1	7314151082499	1	35,64	365
4543-1/S	7314151818623	1	15,06	365
4543-10	7314151721466	1	49,32	365
4543-2	7314151082505	1	37,64	365
4543-2/S	7314151818661	1	15,07	365
4543-20	7314151721541	1	53,31	365
4543-3	7314151721381	1	65,63	365
4543-3/S	7314151818708	1	18,03	365
4543-30	7314151721626	1	75,48	365
4544-1	7314151844004	1	81,03	365
4544-10	7314151844042	1	116,74	365
4544-110/S	7314150224777	1	19,51	365
4544-2	7314151844011	1	128,25	365
4544-20	7314151844059	1	174,49	365
4544-220/S	7314150224784	1	38,45	365
4544-3	7314151844028	1	192,28	365
4544-30	7314151844066	1	256,56	365
4544-4	7314151844035	1	262,43	365
4544-440/S	7314150224791	1	46,73	365
4545-1	7314151082543	1	58,58	368
4545-2	7314151082550	1	79,64	368
4545-3	7314151082567	1	103,55	368
4545-4	7314151722272	1	136,30	368
4545-5	7314151722357	1	166,49	368
4545-N1	7314151722432	1	119,81	367
4545-N11	7314150249169	1	281,45	367
4545-N2	7314151804947	1	164,62	367
4545-N21	7314150249176	1	206,15	367
4551-A	7314151082628	1	90,32	366
4551-B	7314151722784	1	114,73	366
4551-C	7314151082642	1	187,07	366
4551-D	7314151082659	1	292,44	366
4552-1	7314151722944	1	142,96	366
4552-2	7314151723088	1	206,56	366
4552-3	7314151723163	1	318,65	366
4553	7314151830649	1	64,31	368
4559-12	7314150113132	1	87,34	239
4559-12A JC	7314150223909	1	53,77	239
4559-18	7314150024513	8	108,60	239
4559-18B JC	7314150113880	1	69,51	239
4559-24	7314150024520	6	129,39	239
4559-24B JC	7314150113897	1	82,81	239
4559-30	7314150024537	5	155,58	239
4559-30B JC	7314150113903	1	99,57	239
4559-36	7314150024544	3	204,21	239
4559-36B JC	7314150113910	1	130,70	239
4559-42	7314150024551	2	286,15	239
4559-42A JC	7314150208876	1	126,49	239
4560-210	7314150178995	1	55,73	239
4574	7314151799014	1	1.153,30	366
4577	7314151838348	1	1.482,71	368
4578	7314150222308	1	597,74	367
4579	7314150222018	1	237,80	368
4580N/7	7314151301361	1	1.527,27	366
4581N-1	7314151724139	1	62,07	366
4581NA	7314151301200	1	82,41	366
4581NB	7314151301217	1	88,76	366
4581NB2	7314151724726	1	94,95	366
4581NC	7314151301224	1	95,17	366
4582N-1	7314151724214	1	62,07	366
4582N-2	7314151724481	1	77,81	366
4582NA	7314151301248	1	101,73	366
4582NB	7314151301255	1	106,16	366
4583N-1	7314151724566	1	98,05	366
4583N-2	7314151724641	1	117,24	366
4583NA	7314151301279	1	162,35	366
4583NB	7314151301286	1	266,15	366
4590SHS5	7314150384822	4	200,60	368
4591	7314151804039	1	65,27	368
4592	7314151804046	1	76,11	368
4593	7314151804053	1	93,36	368
4594VWT4	7314150403639	5	355,90	335
45S/H1.5	7314150218530	1	17,56	165
45S/H1.5-2P	7314150261505	1	7,02	165
45S/H2	7314150218547	1	17,56	165
45S/H2-2P	7314150261512	1	7,02	165
45S/H2.5	7314150218554	1	17,56	165
45S/H2.5-2P	7314150261529	1	7,02	165
45S/H3	7314150218561	1	17,56	165
45S/H3-2P	7314150261536	1	7,02	165
45S/PH1	7314150218516	1	16,89	165
45S/PH1-2P	7314150261482	1	6,75	165
45S/PH2	7314150218523	1	18,93	165



45S/PH2-2P

			€	
45S/PH2-2P	7314150261499	1	7,57	165
4610-1	7314151724993	1	236,47	368
4611-2	7314151725372	1	79,11	368
4611-3	7314150125043	1	154,96	368
4614-1	7314151725457	1	154,87	366
4614-2	7314151725532	1	189,27	366
4626-10.0	7314150457670	1	9,25	156
4626-4.0	7314150457632	1	5,54	156
4626-5.0	7314150457649	1	6,10	156
4626-6.0	7314150457656	1	6,40	156
4626-8.0	7314150457663	1	7,64	156
4629-10.0	7314150465385	1	8,25	156
4629-4.0	7314150465347	1	5,30	156
4629-5.0	7314150465354	1	5,55	156
4629-6.0	7314150465361	1	6,16	156
4629-8.0	7314150465378	1	7,40	156
4629-SET-5	7314150467204	10	35,55	156
4630	7314150216154	1	23,60	610
4641-10-120	7314150383085	1	5,49	150
4641-10-200	7314150383115	1	8,49	150
4641-10-400	7314150383207	1	13,95	150
4641-10-600	7314150383221	1	15,45	150
4641-11-150	7314150383122	1	6,35	150
4641-12-150	7314150383139	1	7,46	150
4641-12-200	7314150383146	1	10,53	150
4641-12-400	7314150383238	1	14,82	150
4641-12-600	7314150383245	1	16,81	150
4641-13-150	7314150383153	1	10,53	150
4641-14-150	7314150383160	1	12,26	150
4641-14-400	7314150383252	1	18,20	150
4641-14-600	7314150383269	1	20,39	150
4641-16-150	7314150383177	1	13,55	150
4641-16-400	7314150383276	1	20,22	150
4641-16-600	7314150383283	1	26,02	150
4641-18-400	7314150383290	1	29,52	150
4641-18-600	7314150383306	1	35,03	150
4641-20-400	7314150383313	1	31,29	150
4641-20-600	7314150383320	1	40,59	150
4641-22-400	7314150383337	1	35,96	150
4641-24-400	7314150383344	1	37,28	150
4641-25-400	7314150383351	1	42,58	150
4641-3-60	7314150382859	1	3,27	150
4641-4-75	7314150382866	1	3,44	150
4641-5-150	7314150382880	1	4,75	150
4641-5-85	7314150382873	1	3,60	150
4641-5-5-85	7314150382897	1	3,60	150
4641-6-100	7314150383016	1	3,71	150
4641-6-150	7314150383023	1	4,93	150
4641-6-400	7314150383184	1	12,32	150
4641-6-5-100	7314150383030	1	3,71	150
4641-7-100	7314150383047	1	4,19	150
4641-8-120	7314150383054	1	4,86	150
4641-8-200	7314150383061	1	7,15	150
4641-8-400	7314150383191	1	13,06	150
4641-9-120	7314150383078	1	4,86	150
4641-PB	7314150383368	1	21,50	150
4643-PB	7314150441679	1	12,63	150
4651-10-1000	7314150386413	1	100,34	149
4651-10-110	7314150386345	1	11,73	149
4651-10-160	7314150386352	1	12,47	149
4651-10-160-10P	7314150475483	1	124,71	149
4651-10-210	7314150386369	1	14,87	149
4651-10-210-10P	7314150475513	1	156,49	149
4651-10-260	7314150386376	1	19,27	149
4651-10-310	7314150386383	1	24,51	149
4651-10-450	7314150386390	1	33,52	149
4651-10-600	7314150386406	1	42,73	149
4651-12-1000	7314150386581	1	100,76	149
4651-12-160	7314150386529	1	15,62	149
4651-12-160-10P	7314150475490	1	156,13	149
4651-12-210	7314150386536	1	18,65	149
4651-12-210-10P	7314150475520	1	186,44	149
4651-12-260	7314150386543	1	22,53	149
4651-12-310	7314150386550	1	29,23	149
4651-12-450	7314150386567	1	36,57	149
4651-12-600	7314150386574	1	43,90	149
4651-14-1000	7314150386659	1	135,12	149
4651-14-160	7314150386598	1	18,02	149
4651-14-210	7314150386604	1	24,10	149
4651-14-260	7314150386611	1	26,71	149
4651-14-310	7314150386628	1	34,47	149
4651-14-450	7314150386635	1	43,37	149
4651-14-600	7314150386642	1	60,54	149
4651-15-160	7314150386666	1	27,76	149
4651-15-260	7314150386673	1	36,14	149
4651-15-450	7314150386680	1	46,83	149
4651-16-1000	7314150386765	1	160,26	149
4651-16-160	7314150386697	1	34,47	149
4651-16-210	7314150386710	1	38,65	149
4651-16-260	7314150386727	1	44,73	149
4651-16-310	7314150386734	1	46,61	149
4651-16-450	7314150386741	1	58,55	149
4651-16-600	7314150386758	1	78,56	149
4651-18-250	7314150386789	1	59,92	149
4651-18-450	7314150386796	1	70,38	149
4651-20-250	7314150386802	1	68,08	149

			€	
4651-20-450	7314150386819	1	80,55	149
4651-22-250	7314150386826	1	81,60	149
4651-22-450	7314150386833	1	97,10	149
4651-24-250	7314150386840	1	82,92	149
4651-24-450	7314150386857	1	102,75	149
4651-25-250	7314150386864	1	85,19	149
4651-25-450	7314150386871	1	104,22	149
4651-28-250	7314150386888	1	98,46	149
4651-28-450	7314150386895	1	119,41	149
4651-30-250	7314150386901	1	125,93	149
4651-30-450	7314150386918	1	130,93	149
4651-32-450	7314150386925	1	169,69	149
4651-5-110	7314150385683	1	7,86	149
4651-5-110-10P	7314150475407	1	78,61	149
4651-5-160	7314150385690	1	8,80	149
4651-5-160-10P	7314150475438	1	87,98	149
4651-5-260	7314150385713	1	16,34	149
4651-5-5-110	7314150385720	1	10,69	149
4651-5-5-110-10P	7314150475414	10	106,84	149
4651-5-5-160	7314150385737	1	11,11	149
4651-5-5-160-10P	7314150475445	1	111,03	149
4651-6-110	7314150385744	1	7,86	149
4651-6-110-10P	7314150475421	1	78,61	149
4651-6-160	7314150385751	1	8,59	149
4651-6-160-10P	7314150475452	1	75,16	149
4651-6-210	7314150385768	1	11,64	149
4651-6-260	7314150385775	1	13,82	149
4651-6-310	7314150385782	1	20,43	149
4651-6-5-110	7314150475391	50	11,09	149
4651-6-5-160	7314150385799	1	11,22	149
4651-6-5-160-10P	7314150475469	1	111,03	149
4651-6-5-210	7314150385805	1	15,09	149
4651-6-5-260	7314150385812	1	20,12	149
4651-6-5-310	7314150385829	1	24,51	149
4651-7-110	7314150385836	1	10,59	149
4651-7-160	7314150386253	1	11,22	149
4651-8-110	7314150386277	1	10,26	149
4651-8-160	7314150386284	1	10,37	149
4651-8-160-10P	7314150475476	1	103,76	149
4651-8-210	7314150386291	1	12,89	149
4651-8-210-10P	7314150475506	1	128,89	149
4651-8-260	7314150386307	1	14,15	149
4651-8-310	7314150386314	1	18,13	149
4651-8-460	7314150386321	1	29,96	149
4651-SET-5	7314150475537	1	43,75	149
4651-SET-7	7314150475544	1	66,41	149
4652-10-110	7314150385119	1	6,19	149
4652-10-160	7314150385126	1	6,91	149
4652-10-160-10P	7314150475322	1	69,13	149
4652-10-210	7314150385133	1	8,28	149
4652-10-210-10P	7314150475353	1	82,81	149
4652-10-260	7314150385140	1	12,15	149
4652-10-310	7314150385164	1	14,15	149
4652-10-450	7314150385171	1	22,95	149
4652-10-600	7314150385188	1	32,06	149
4652-11-160	7314150385195	1	9,12	149
4652-11-260	7314150385218	1	14,15	149
4652-12-1000	7314150385287	1	79,30	150
4652-12-160	7314150385225	1	7,32	149
4652-12-160-10P	7314150475339	1	73,20	149
4652-12-210	7314150385232	1	9,33	149
4652-12-210-10P	7314150475360	1	93,28	149
4652-12-260	7314150385249	1	13,31	149
4652-12-310	7314150385256	1	17,70	149
4652-12-450	7314150385263	1	20,85	150
4652-12-600	7314150385270	1	33,21	150
4652-13-310	7314150385300	1	17,17	150
4652-14-1000	7314150385379	1	86,21	150
4652-14-160	7314150385317	1	10,06	150
4652-14-210	7314150385324	1	14,71	150
4652-14-260	7314150385331	1	17,70	150
4652-14-310	7314150385348	1	18,65	150
4652-14-450	7314150385355	1	24,51	150
4652-14-600	7314150385362	1	36,35	150
4652-15-260	7314150385393	1	18,33	150
4652-16-1000	7314150385478	1	97,94	150
4652-16-210	7314150385416	1	17,08	150
4652-16-260	7314150385423	1	18,44	150
4652-16-310	7314150385430	1	19,69	150
4652-16-450	7314150385447	1	29,11	150
4652-16-600	7314150385454	1	39,17	150
4652-18-1000	7314150385515	1	100,67	150
4652-18-200	7314150385485	1	21,90	150
4652-18-300	7314150385492	1	29,23	150
4652-18-450	7314150385508	1	33,31	150
4652-20-1000	7314150385560	1	101,60	150
4652-20-200	7314150385522	1	30,49	150
4652-20-300	7314150385539	1	34,26	150
4652-20-450	7314150385546	1	43,15	150
4652-20-600	7314150385553	1	63,90	150
4652-22-1000	7314150385607	1	102,65	150
4652-22-250	7314150385577	1	39,17	150
4652-22-450	7314150385584	1	54,46	150
4652-22-600	7314150385591	1	65,26	150
4652-24-250	7314150385614	1	45,57	150
4652-24-450	7314150385621	1	59,29	150

			€	
4652-25-1000	7314150385652	1	114,17	150
4652-25-250	7314150385638	1	49,44	150
4652-25-450	7314150385645	1	63,47	150
4652-26-250	7314150385669	1	61,80	150
4652-26-450	7314150385676	1	70,18	150
4652-3-110	7314150475216	50	8,38	149
4652-3,5-110	7314150475223	50	8,38	149
4652-4-110	7314150384365	1	5,76	149
4652-4-160	7314150384372	1	6,91	149
4652-5-110	7314150384815	1	4,17	149
4652-5-110-10P	7314150475247	1	41,78	149
4652-5-160	7314150384839	1	5,45	149
4652-5-160-10P	7314150475278	1	54,46	149
4652-5-210	7314150384846	1	8,59	149
4652-5,5-110	7314150384853	1	4,93	149
4652-5,5-110-10P	7314150475254	10	49,29	149
4652-5,5-160	7314150384860	1	6,19	149
4652-5,5-160-10P	7314150475285	1	61,86	149
4652-5,5-210	7314150475230	50	8,38	149
4652-6-110	7314150384877	1	4,30	149
4652-6-110-10P	7314150475261	1	43,01	149
4652-6-160	7314150384891	50	5,03	149
4652-6-160-10P	7314150475292	1	50,28	149
4652-6-210	7314150384907	1	8,17	149
4652-6-260	7314150384969	1	10,46	149
4652-6,5-110	7314150384976	1	4,93	149
4652-6,5-160	7314150384990	1	5,76	149
4652-6,5-160-10P	7314150475308	1	57,67	149
4652-7-110	7314150385003	1	6,19	149
4652-7-160	7314150391981	1	6,61	149
4652-8-110	7314150385034	1	5,14	149
4652-8-160	7314150385058	1	5,45	149
4652-8-160-10P	7314150475315	1	54,46	149
4652-8-210	7314150385065	1	7,32	149
4652-8-210-10P	7314150475346	1	73,20	149
4652-8-260	7314150385072	1	10,37	149
4652-8-460	7314150385089	1	21,90	149
4652-9-160	7314150385096	1	8,28	149
4652-9-210	7314150385102	1	9,01	149
4652-SET-5	7314150475377	1	18,48	150
4652-SET-7	7314150475384	1	28,83	150
4655-FLAT-250	7314150387823	1	11,11	151
4655-HOLLOW-240	7314150387847	1	22,83	151
4655-POINT-250	7314150387816	1	11,11	151
4655-SLOT-25032	7314150387885	1	146,64	151
4655-TILE-20040	7314150387861	1	21,58	151
4655-WIDE-20040	7314150387830	1	18,85	151
4655-WING-C-250	7314150387854	1	54,99	151
4656-12-340	7314150386932	1	63,38	148
4656-12-540	7314150387021	1	74,36	148
4656-14-340	7314150387069	1	68,08	148
4656-14-540	7314150387076	1	78,04	148
4656-15-340	7314150387083	1	78,56	148
4656-16-1320	7314150387137	1	272,33	148
4656-16-340	7314150387106	1	81,18	148
4656-16-540	7314150387113	1	84,84	148
4656-16-940	7314150387120	1	157,11	148
4656-18-1320	7314150387175	1	288,04	148
4656-18-340	7314150387144	1	83,28	148
4656-18-540	7314150387151	1	99,51	148
4656-18-940	7314150387168	1	151,88	148
4656-20-1320	7314150387212	1	340,41	148
4656-20-320	7314150387182	1	78,56	148
4656-20-520	7314150387199	1	101,60	148
4656-20-920	7314150387205	1	144,54	148
4656-22-1320	7314150387250	1	366,60	148
4656-22-320	7314150387229	1	96,36	148
4656-22-520	7314150387236	1	115,21	148
4656-22-920	7314150387243	1	157,11	148
4656-24-320	7314150387267	1	93,23	148
4656-24-520	7314150387274	1	115,21	148
4656-25-1320	7314150387311	1	396,98	148
4656-25-320	7314150387281	1	102,65	148
4656-25-520	7314150387298	1	125,69	148
4656-25-920	7314150387304	1	186,44	148
4656-26-520	7314150387328	1	125,69	148
4656-28-370	7314150387434	1	123,59	148
4656-28-570	7314150387458	1	135,12	148
4656-28-670	7314150387489	1	170,73	148
4656-28-920	7314150387526	1	204,25	148
4656-30-370	7314150387540	1	135,12	148
4656-30-570	7314150387571	1	144,54	148
4656-32-1320	7314150387649	1	408,49	148
4656-32-370	7314150387595	1	141,41	148
4656-32-570	7314150387618	1	175,97	148
4656-32-920	7314150387632	1	239,86	148
4656-35-370	7314150387656	1	156,07	148
4656-35-570	7314150387663	1	187,49	148
4656-35-670	7314150387670	1	219,96	148
4656-37-370	7314150387687	1	157,11	148
4656-37-570	7314150387694	1	187,49	148
4656-37-920	7314150387700	1	282,80	148
4656-38-370	7314150387717	1	272,33	148
4656-38-570	7314150387724	1	187,49	148
4656-40-1320	7314150387762	1	492,29	148
4656-40-370	7314150387731	1	183,30	148

			€	
4656-40-570	7314150387748	1	225,20	148
4656-40-920	7314150387755	1	293,28	148
4656-45-570	7314150387779	1	303,75	148
4656-45-920	7314150387786	1	417,92	148
4656-50-570	7314150387793	1	366,60	148
4656-52-570	7314150387809	1	429,44	148
4659-FLAT -28	7314150387922	1	17,29	151
4659-FLAT -40	7314150387939	1	20,01	151
4659-FLAT -60	7314150387946	1	25,98	151
4659-POINT-28	7314150387892	1	16,76	151
4659-POINT-40	7314150387908	1	20,01	151
4659-POINT-60	7314150387915	1	27,03	151
4659-TILE-30-5	7314150388042	1	47,35	151
4659-TILE-30-8	7314150388059	1	49,76	151
4659-WIDE-30-8	7314150387953	1	44,83	151
4659-WIDE-36-5	7314150387984	1	29,86	151
466-1000	7314150128327	4	48,11	539
466-1000-M	7314150186105	4	59,61	539
466-1200	7314150128334	4	58,24	539
466-1200-M	7314150186129	4	70,94	539
466-1800	7314150128341	4	75,11	539
466-2000	7314150129836	4	91,62	539
466-250	7314150128655	10	29,24	541
466-400	7314150128297	4	32,59	539
466-400-M	7314150128358	4	40,96	539
466-600	7314150128303	4	39,67	539
466-600-M	7314150128365	4	48,12	539
466-800	7314150128310	4	43,03	539
466-800-M	7314150186082	4	52,00	539
466-BE1	7314150215218	12	6,43	541
466-LINE	7314150215249	12	5,34	541
466-POST	7314150215232	6	9,02	541
4724-JT	7311518265847	1	17,63	635
4728-JT	7311518265854	1	18,21	635
474-125-0-60	7311518029050	10	9,86	549
474-125-0-80	7311518029869	10	10,01	549
474-150-0-60	7311518029876	10	10,35	549
474-150-0-80	7311518029883	10	10,52	549
4750-2PP-1	7314153014733	1	45,05	469
4750-3PB-2	7314150187782	1	129,33	474
4750-BWC-1	7314153018809	1	29,08	469
4750-DHO-3	7314150289530	1	34,27	469
4750-EP-1	7314153014726	1	56,64	469
4750-FOLTC-1	7314153019271	1	171,29	467
4750-HDB-2	7314150289486	1	51,11	468
4750-HDBS-2	7314150289479	1	162,30	468
4750-HDLB-1	7314153014757	1	32,02	468
4750-HDLB-TAH	7314150303892	1	61,58	474
4750-HHO-2	7314153014863	1	21,47	474
4750-JU3PB-1	7314153015747	1	35,63	468
4750-KNHO-1	7314153015839	1	18,21	469
4750-KP-1	7314153014771	1	44,43	469
4750-LV-1	7314150358052	1	10,86	467
4750-LV-2	7314150393800	1	10,87	467
4750-MPH-1	7314150291625	1	28,03	469
4750-QRFB-1	7314150289455	1	21,25	468
4750-ROCO-1	7314153015273	1	20,70	469
4750-TOCST-1	7314153018779	1	64,74	467
4750-UP-2	7314150187768	1	60,79	474
4750-VDEC	7314150222377	1	252,79	468
4750-VMPH-1	7314153014818	1	22,40	469
4750ALC01FF1	7314150508884	1	808,55	440
4750BMC10	7314150264032	1	22,43	463
4750BMC10FF1	7314150500673	1	494,40	462
4750BMC3	7314150359639	1	5,06	463
4750BMC4	7314150426256	1	9,11	463
4750BMC5	7314150264001	1	12,39	463
4750BMC5,5	7314150326167	1	13,75	463
4750BMC6	7314150264018	1	15,93	463
4750BMC7	7314150277605	1	16,41	463
4750BMC9	7314150264025	1	16,76	463
4750BMC9,5	7314150326174	1	21,13	463
4750BMC1	7314150541294	1	30,80	421
4750FB1-19A	7314150277612	1	78,60	466
4750FB1-19B	7314150277629	4	107,25	466
4750FB2-19A	7314150277636	4	64,91	466
4750FB2-19TS001	7314150302772	1	560,68	463
4750FB2-24A	7314150277643	2	97,51	466
4750FB2W-24A	7314150277650	1	192,45	466
4750FB2W-TS001	7314150302765	1	670,28	463
4750FB3-12	7314150277667	1	79,72	466
4750FB4-18	7314150277674	4	109,64	466
4750FB4-18TS001	7314150302758	1	745,29	464
4750FB5-FG1	7314150401796	1	19,11	467
4750FB5-FG2	7314150401819	1	22,10	467
4750FB5A	7314150277704	1	10,63	467
4750FB5ATS001	7314150302727	1	131,76	465
4750FB5B	7314150277698	1	18,67	467
4750FB5BFF1	7314150302734	1	194,78	465
4750FB5C	7314150277681	8	24,36	467
4750FB6-13	7314150393091	1	19,20	466
4750FB6-19	7314150393114	1	26,09	467
4750FB7-01	7314150465668	60	22,23	468
4750FB7-02	7314150465675	60	26,29	468
4750FB7ORBG	7314150465682	120	8,99	468
4750FB7ORLT	7314150465699	120	7,85	468



4750FB8



4750FB8	7314150465651	4	100,73	465
4750PTB50	7314150275007	3	48,15	463
4750PTB60	7314150275014	3	55,38	463
4750PTB65	7314150345809	2	62,17	463
4750PTB65TS5	7314150456260	1	223,43	462
4750PTBW47	7314150275021	1	78,26	462
4750PTBW67	7314150289189	1	98,73	462
4750RC01	7314150220151	1	216,87	443
4750RC02	7314150220168	1	257,53	443
4750RC021	7314150226641	1	292,82	443
4750RCHD-AC1	7314150229857	1	37,97	444
4750RCHD00	7314150271603	1	222,13	443
4750RCHD01	7314150227426	1	281,55	442
4750RCHD011	7314150229802	1	458,35	443
4750RCHD01AC1	7314150229819	1	52,38	444
4750RCHD01AC2	7314150229826	1	124,42	444
4750RCHD01FF1	7314150247578	1	2.749,85	440
4750RCHDW01	7314150227433	1	325,43	442
4750RCHDW01AC1	7314150229833	1	52,38	444
4750RCHDW01AC2	7314150229840	1	124,42	444
4750RCHDW01FF1	7314150247561	1	4.150,39	439
4750RCHDW01FF2	7314150249183	1	2.999,37	439
4750RCHDW01FF3	7314150249190	1	2.671,03	439
4750RCHDW01FF4	7314150309580	1	1.876,90	440
4750RCHDW01FF9	7314150345533	1	2.834,84	440
4750RCHDW01RED	7314150407538	1	325,43	442
4750RCHDW02	7314150227440	1	510,75	442
4750RCHDW02FF1	7314150267422	1	2.492,05	437
4750RCHDW02FF15	7314150347698	1	3.661,68	439
4750RCHDW02FF2	7314150306787	1	2.807,14	438
4750RCHDW02FF4	7314150309559	1	3.959,33	438
4750RCHDW02RED	7314150407545	1	510,75	442
4750RCHDW02RF1V	7314150422081	1	3.036,30	437
4750RCHDW10	7314150425587	1	687,46	442
4750RCW01	7314150220182	1	515,07	443
4750RCW011	7314150226627	1	554,61	443
4750RCWD-AC1	7314150277179	1	80,21	443
4750RCWD-AC2	7314150277186	1	74,04	443
4750RCWD-AC3	7314150277193	1	74,04	443
4750RCWD-AC4	7314150277209	1	55,54	443
4750RCWD4	7314150277124	1	777,48	442
4750RCWD4-OR	7314150409501	1	777,48	442
4750RCWD4FF1	7314150302413	1	2.183,69	436
479-08	7311518025441	6	18,34	593
479-12	7311518025458	6	19,56	593
479-16	7311518025465	6	22,40	593
479-20	7314150319862	6	23,98	593
479-24	7311518025472	6	25,65	593
479-32	7311518025489	6	27,70	593
479F-08	7314150441952	6	21,22	593
479F-12	7314150441976	6	22,51	593
479F-16	7314150441983	6	25,76	593
479F-20	7314150441990	6	27,58	593
479F-24	7314150442003	6	29,50	593
479F-32	7314150442010	6	31,85	593
480-08	7311518025496	4	23,05	594
480-10	7311518025502	6	24,92	594
480-12	7311518025519	6	26,93	594
480-14	7311518025526	4	36,80	594
480-20	7314150319763	4	30,29	594
481-100	7311518005030	6	12,38	593
481-1000	7311518005092	6	30,52	593
481-1500	7311518025533	6	41,67	593
481-200	7311518005047	6	13,89	593
481-2000	7314150319855	6	61,34	593
481-300	7311518005054	6	16,38	593
481-400	7311518005061	6	18,10	593
481-500	7311518005078	6	20,82	593
481-800	7311518025540	6	27,77	593
481F-100	7314150442072	6	14,24	593
481F-1000	7314150442133	6	35,09	593
481F-1500	7314150442140	4	47,92	593
481F-200	7314150442089	4	15,97	593
481F-2000	7314150442157	4	70,55	593
481F-300	7314150442096	6	18,84	593
481F-400	7314150442102	6	20,82	593
481F-500	7314150442119	6	23,94	593
481F-800	7314150442126	6	31,94	593
482-25	7311518025557	6	16,08	593
482-28	7311518025564	6	17,51	593
482-30	7311518025571	6	20,35	593
482-35	7311518025595	6	23,90	593
482-40	7311518025601	6	26,50	593
482-45	7311518027551	6	27,74	593
482F-25	7314150442225	4	18,50	593
482F-28	7314150442232	4	20,14	593
482F-30	7314150442249	6	23,41	593
482F-35	7314150442256	4	27,49	593
482F-40	7314150442263	2	30,47	593
482F-45	7314150442270	4	31,89	593
483-16	7311518024314	6	9,93	594
483-20	7311518024321	6	11,05	594
483-22	7311518005108	6	11,96	594
483-25	7311518005115	6	13,48	594
483-28	7311518024284	6	14,98	594
4830	7314150100057	3	42,75	242



4831	7314150103393	3	45,46	242
4833	7314150100064	3	47,00	243
483F-16	7314150442164	6	11,42	594
483F-20	7314150442171	6	12,71	594
483F-22	7314150442188	6	13,76	594
483F-25	7314150442195	6	15,50	594
483F-28	7314150442201	6	17,22	594
483F-30	7314150442218	4	18,81	594
484-1000	7311518005122	6	30,48	594
484-1250	7311518005139	6	34,48	594
484-1500	7311518005146	6	39,01	594
484-2000	7311518024338	4	42,98	594
484F-1000	7314150442027	6	35,05	594
484F-1250	7314150442034	6	39,65	594
484F-1500	7314150442041	6	44,86	594
484F-2000	7314150442058	4	49,42	594
485	7311518005153	6	31,37	594
485W-650	7314150319770	6	28,74	594
485W-750	7314150319787	6	30,48	594
486	7311518005160	4	30,26	595
486-1800	7314150315307	5	58,84	541
486-1800WH	7314150315338	5	58,84	541
486-2000	7314150315314	5	64,52	541
486-2000WH	7314150315345	5	64,52	541
486-2400	7314150315321	5	75,73	541
486-2400WH	7314150315352	5	75,73	541
486-700	7314150338078	6	22,92	595
486F-700	7314150338085	6	29,37	595
486W-500	7314150319794	4	23,05	595
486W-600	7314150319800	4	23,75	595
488-2000	7314150337972	2	35,22	595
488-3000	7314150337989	2	42,58	595
488-4000	7314150337996	2	49,35	595
488-5000	7314150338009	2	59,03	595
488-6000	7314150338016	1	64,87	595
488F-2000	7314150338023	2	39,67	595
488F-3000	7314150338030	2	46,29	595
488F-4000	7314150338047	2	52,40	595
488F-5000	7314150338054	4	62,21	595
488F-6000	7314150338061	2	67,52	595
489-1100	7314150133055	8	111,08	597
489-1800	7314150133062	8	111,43	597
489-2700	7314150133079	4	209,03	597
489-3600	7314150133086	4	249,00	597
489-4500	7314150133093	4	269,65	597
489-5400	7314150133109	4	299,95	597
490-3.5	7311518025373	4	22,22	594
491-3000	7314150345199	4	36,89	597
491-4000	7314150345205	4	41,08	597
491-5000	7314150345212	4	48,55	597
491-6000	7314150345229	4	53,67	597
492-3.5	7311518025380	6	28,49	594
493-500	7314150338139	6	22,88	596
493-600	7314150338146	6	24,54	596
493F-500	7314150338153	6	27,44	596
493F-600	7314150338160	1	29,85	596
494-600	7311518025397	4	31,21	596
495-500	7314150338191	6	23,35	596
495-600	7314150338207	6	24,34	596
495F-500	7314150338184	6	26,72	596
495F-600	7314150338177	1	29,37	596
496-1500	7314150315147	5	73,42	541
496-1800	7314150315154	5	85,67	541
496-SPARE	7314150329304	1	7,46	542
4M-10-11	7314151829438	10	11,19	53
4M-12-13	7314151829445	10	12,23	53
4M-14-15	7314151829476	10	13,41	53
4M-16-17	7314151829490	10	14,42	53
4M-17-19	7314151829506	10	14,99	53
4M-18-19	7314151829513	10	14,99	53
4M-20-22	7314151829520	10	17,31	53
4M-21-23	7314150205363	5	18,96	53
4M-24-26	7314150205370	1	21,27	53
4M-24-27	7314151829551	1	21,27	53
4M-25-28	7314150205387	1	24,03	53
4M-27-29	7314150205394	1	28,83	53
4M-30-32	7314151829575	1	30,30	53
4M-6-7	7314151829407	10	9,75	53
4M-8-9	7314151829414	10	10,07	53
4M/10C	7314150212972	1	161,00	53
4M/10T	7314151829605	1	178,83	53
4M/12C	7314150212989	1	216,17	54
4M/8	7314150180493	1	120,17	54
5-600-21-D-1P	7311518189341	10	136,96	35
5-610-21-D-1P	7311518189358	5	135,88	35
5-630-21-D-1P	7311518189365	1	97,03	35
5-670-21-D-1P	7311518189389	1	144,08	35
500-12	7314150390977	1	120,53	270
500-14	7314150414505	1	129,22	270
500-15	7314150390984	1	133,23	270
500-16	7314150414512	1	139,57	270
500-18	7314150414543	1	164,33	270
500-22	7314150414567	1	188,31	270
502	7311518130589	25	10,03	566
502-SET2	7311518130664	35	5,82	566
502-SET6	7311518130633	10	26,06	566

			€	
5050	7314151083359	1	101,06	360
51-12	7311518044565	10	3,58	634
51-21	7311518003906	10	4,83	634
51-24	7311518003913	10	5,16	634
51-30	7311518003920	10	5,78	634
51-32	7311518003937	10	6,00	634
51-36	7311518003944	10	6,23	634
510031	7314150216338	5	37,03	215
510033	7314150216345	5	24,41	215
510034	7314150216314	10	17,37	214
5124-JS-H	7311518219352	4	51,03	635
5128-JS-H	7311518219369	4	57,25	635
52	7311518276027	12	4,33	308
5226 DC	7314150120352	1	54,75	248
527 D-160	7314150032723	5	26,42	236
527 D-200	7314150032730	5	31,56	236
527 GC-160	7314150205653	3	32,93	236
527 GC-200	7314150205660	3	39,32	236
527V-160	7314150126811	2	48,74	499
527V-200	7314150126828	2	53,47	499
528-700	7311518188993	1	48,52	573
528-COM	7311518188986	1	40,60	573
529-16-L	7314150198139	4	38,64	592
529-16-XL	7314150198146	4	40,72	592
529-20-L	7314150198160	4	40,72	592
529-20-XL	7314150198153	4	42,78	592
529S-16-XL	7314150340330	4	39,73	592
529S-20-XL	7314150340347	4	41,74	592
541 D-150	7314150032754	5	16,62	237
541 D-200	7314150032761	5	18,89	237
541 D-250	7314150032778	5	24,77	237
5418	7314151084370	1	46,79	536
5419/6T	7314151821562	1	54,70	536
541D-180	7314150127160	5	17,81	237
541D-225	7314150127290	5	21,77	237
5463 R	7314151085063	5	56,96	534
5463-120	7314151085001	5	34,03	534
54640	7314150215720	1	19,58	169
5465 AMT	7314151085148	5	56,96	532
5465 R	7314151085162	5	54,08	534
5468-112	7314151085247	5	26,06	532
5469 B	7314151085322	5	24,46	532
5469 BI	7314151085346	5	26,18	532
5469 I	7314151085407	5	28,45	532
5469 R	7314151085421	5	39,43	532
5469-127	7314151085285	5	25,32	532
5470-120	7314151085452	5	21,66	534
5471 F-120	7314151085681	5	20,91	532
5471 F-145	7314151085704	5	22,66	532
5471 F-200	7314151085728	5	46,01	532
5471 F-250	7314151085742	5	58,83	532
5471 F-300	7314151085766	5	80,87	532
5471 FI-120	7314151085780	5	22,02	532
5471 FI-200	7314151085827	5	44,29	532
5471 FR-120	7314151085889	5	36,01	532
5471 FR-145	7314151085902	5	40,85	532
5475 K	7314151086244	5	27,25	532
5475 R	7314151086268	5	49,47	532
5476 H	7314151086305	5	63,96	534
5479-130	7314151086398	5	18,88	532
5488 AM	7314151821166	5	41,77	533
5489 AM	7314151821173	5	41,77	533
5490 AM	7314151821180	5	41,77	533
5493-115	7314151821234	5	66,50	534
5515B	7314151086978	25	25,74	361
5515FL	7314150504077	10	38,05	361
5515FUV	7314150540143	1	50,55	361
5515GV	7314151481483	1	35,72	360
5515L	7314151481568	1	27,16	361
5515M	7314151086985	1	35,59	361
5515T	7314151589172	25	31,44	361
5515T-52	7314153021939	25	13,37	360
5516	7314151086992	5	24,03	532
5516 I	7314151087029	5	26,36	532
5517	7314151573843	5	27,78	532
5517 I	7314151573928	5	27,23	532
5518	7314151087043	5	30,35	532
5521	7314150215713	1	53,14	169
5540 AM	7314151821319	5	41,77	532
5541 AM	7314151821326	5	41,77	533
5544 AM	7314151821357	5	41,77	533
5545 AM	7314151821364	5	41,77	533
5546 AM	7314151821371	5	41,77	533
5547 AM	7314151821388	5	41,77	533
5549 AM	7314151821401	5	41,77	533
5550-3.2	7314151475673	10	18,16	536
5550-4.5	7314151475758	10	21,13	536
5551	7314151378479	1	19,62	536
5552	7314151378554	1	19,62	536
5553	7314151378639	1	19,62	536
5554	7314151378714	1	19,62	536
5568/5	7314151821210	1	222,68	534
5573-145	7314151473112	5	63,67	533
5577-145	7314151574062	5	64,38	534
5578-115	7314151547769	5	45,20	533
5579-115	7314151547844	5	45,20	533

			€	
5588 AM	7314151821432	5	41,77	534
5589 AM	7314151821449	5	41,77	534
5590 AM	7314151821456	5	41,77	534
5600/4	7314151436773	1	91,66	536
5724-JS	7311518216085	1	34,24	635
5728-JS	7311518216092	1	39,31	635
5750	7311518280949	1	18,30	343
5770	7314150504466	12	73,81	343
583D	7314150023721	4	87,80	577
584D	7314150023745	4	84,63	577
585D	7314150104185	4	84,55	577
586D	7314150104208	4	82,17	577
59/S100BC	7314150337637	1	45,25	167
59/S100BC-IP	7314150337644	8	45,25	167
59/S100C	7314150413003	1	4,52	165
59/S28-4	7314151847173	1	117,33	166
59/S31B	7314150325788	1	15,71	166
59/S31B-IP	7314150325795	12	15,40	166
59/S35BC	7314150412990	1	64,35	167
59/S36BCR	7314150413232	6	54,53	211
59/S54BC	7314150337613	1	34,56	167
59/S54BC-IP	7314150337620	8	34,56	167
59S/0.5-3.0	7314150199815	1	12,68	160
59S/0.5-3.0-3P	7314150259205	1	3,81	160
59S/0.5-4.0	7314150199822	1	12,68	160
59S/0.5-4.0-3P	7314150259212	1	3,81	160
59S/0.6-3.5	7314150199839	1	12,68	160
59S/0.6-3.5-3P	7314150259229	1	3,81	160
59S/0.6-4.5	7314150198801	1	12,68	160
59S/0.6-4.5-3P	7314150201600	1	3,81	160
59S/0.8-5.5	7314150198849	1	12,68	160
59S/0.8-5.5-3P	7314150201624	1	3,81	160
59S/1.0-5.5	7314150198863	1	12,68	160
59S/1.0-5.5-3P	7314150258963	1	3,81	160
59S/1.2-6.5	7314150198887	1	12,68	160
59S/1.2-6.5-3P	7314150258970	1	3,81	160
59S/1.2-8.0	7314150198900	1	20,60	160
59S/1.2-8.0-3P	7314150258987	1	6,19	160
59S/1.6-1.0	7314150199846	1	20,60	160
59S/1.6-1.0-3P	7314150259236	1	6,19	160
59S/1.6-9.0	7314150199853	1	20,60	160
59S/1.6-9.0-3P	7314150259243	1	6,19	160
59S/125PH1	7314150206834	1	34,36	164
59S/125PH1-2P	7314150260553	1	13,74	164
59S/125PH2	7314150204298	1	34,36	164
59S/125PH2-2P	7314150260560	1	13,74	164
59S/125PH2-IP	7314150342433	100	2,58	164
59S/125PH3	7314150204304	1	34,36	164
59S/125PH3-2P	7314150260577	1	13,74	164
59S/125PZ1	7314150200733	1	34,36	164
59S/125PZ1-2P	7314150260522	1	13,74	164
59S/125PZ2	7314150200740	1	34,36	164
59S/125PZ2-2P	7314150260539	1	13,74	164
59S/125PZ3	7314150200757	1	34,36	164
59S/125PZ3-2P	7314150260546	1	13,74	164
59S/150T15	7314150200764	1	51,53	164
59S/150T15-2P	7314150260584	1	20,61	164
59S/150T20	7314150200771	1	51,53	164
59S/150T20-2P	7314150260591	1	20,61	164
59S/150T25	7314150200788	1	51,53	164
59S/150T25-2P	7314150260607	1	20,61	164
59S/150T30	7314150200795	1	51,53	164
59S/150T30-2P	7314150260614	1	20,61	164
59S/17-1	7314150191499	1	21,69	165
59S/17-2	7314150191505	1	22,67	166
59S/17-3	7314150191512	1	21,99	166
59S/22-1	7314150204229	1	30,77	166
59S/22-2	7314150204236	1	30,77	166
59S/31-1	7314150191451	1	24,04	166
59S/31-2	7314150191468	1	24,72	167
59S/31-3	7314150191475	1	28,88	167
59S/50/0.6-3.5	7314150199976	1	17,17	162
59S/50/0.8-4.0	7314150200009	1	17,17	162
59S/50/0.8-5.5	7314150200023	1	17,17	162
59S/50/1.0-6.0	7314150200047	1	17,17	162
59S/50/1.2-6.5	7314150200061	1	17,17	162
59S/50/3.5-2P	7314150260027	1	6,87	162
59S/50/4.0-2P	7314150260041	1	6,87	162
59S/50/5.5-2P	7314150260065	1	6,87	162
59S/50/6.0-2P	7314150260089	1	6,87	162
59S/50/6.5-2P	7314150260102	1	6,87	162
59S/50H1/16	7314150248926	1	20,48	163
59S/50H1/4	7314150249015	1	20,48	163
59S/50H1/8	7314150248964	1	20,48	163
59S/50H2	7314150200160	1	21,14	163
59S/50H2-2P	7314150259298	1	5,28	163
59S/50H2.5-5P	7314150531653	1	8,75	163
59S/50H2.5-2P	7314150259304	1	5,28	163
59S/50H3	7314150200184	1	21,14	163
59S/50H3-2P	7314150259335	1	5,28	163
59S/50H3/16	7314150248995	1	20,48	163
59S/50H3/32	7314150248940	1	20,48	163
59S/50H3/8	7314150249039	1	20,48	163
59S/50H4-5P	7314150531691	1	8,75	163
59S/50H4-2P	7314150259359	1	5,28	163
59S/50H5-5P	7314150531714	1	8,75	163



59S/50H5-2P



59S/50H5-2P	7314150259373	1	5,28	163
59S/50H5/16	7314150249022	1	20,48	163
59S/50H5/32	7314150248988	1	20,48	163
59S/50H5/64	7314150248933	1	20,48	163
59S/50H6	7314150200214	1	21,14	163
59S/50H6-2P	7314150259397	1	5,28	163
59S/50H7/32	7314150249008	1	20,48	163
59S/50H7/64	7314150248957	1	20,48	163
59S/50H8-2P	7314150259410	1	5,28	163
59S/50H8-5P	7314150531752	1	21,14	163
59S/50H9/64	7314150248971	1	20,48	163
59S/50PH1	7314150199860	1	13,88	162
59S/50PH1-2P	7314150203642	1	6,88	162
59S/50PH2-5P	7314150531790	1	8,75	162
59S/50PH2-2P	7314150203758	1	6,88	162
59S/50PH3-2P	7314150203802	1	6,88	162
59S/50PH3-5P	7314150531813	1	13,88	162
59S/50PZ1-2P	7314150204007	1	6,88	163
59S/50PZ2-2P	7314150204014	1	6,88	163
59S/50PZ2-5P	7314150531851	1	13,88	163
59S/50PZ3-2P	7314150204021	1	6,88	163
59S/50PZ3-5P	7314150531875	1	13,88	163
59S/50R1	7314150200238	1	27,74	163
59S/50R1-2P	7314150259441	1	11,11	163
59S/50R2	7314150200245	1	27,74	163
59S/50R2-2P	7314150259472	1	11,11	163
59S/50R3	7314150200252	1	27,74	163
59S/50R3-2P	7314150259502	1	11,11	163
59S/50T10	7314150200092	1	18,49	163
59S/50T10-2P	7314150201723	1	9,78	163
59S/50T15	7314150200108	1	18,49	163
59S/50T15-2P	7314150201730	1	9,78	163
59S/50T20-5P	7314150531936	1	9,30	163
59S/50T20-2P	7314150201747	1	9,78	163
59S/50T25	7314150200122	1	18,49	163
59S/50T25-2P	7314150201754	1	9,78	163
59S/50T27	7314150200139	1	18,49	163
59S/50T30	7314150200146	1	18,49	163
59S/50T30-2P	7314150201761	1	9,78	163
59S/50T40	7314150200153	1	18,49	163
59S/50T40-2P	7314150259281	1	9,78	163
59S/50T8	7314150200085	1	18,49	163
59S/50T8-2P	7314150262809	1	9,78	163
59S/60PEN/DISP	7314150459032	1	184,31	168
59S/7-1	7314150191536	1	12,39	165
59S/7-2	7314150191543	1	13,08	165
59S/7-3	7314150191550	1	23,19	165
59S/7-4	7314150191567	1	13,54	165
59S/70PH1-2P	7314150259526	1	9,25	163
59S/70PH2-2P	7314150259557	1	9,25	163
59S/70PH2-5P	7314150532032	1	23,12	163
59S/70PZ1	7314150200283	1	23,12	163
59S/70PZ1-2P	7314150259564	1	9,25	163
59S/70PZ2	7314150200290	1	23,12	163
59S/70PZ2-2P	7314150260331	1	9,25	163
59S/70PZ3	7314150200306	1	23,12	163
59S/70PZ3-2P	7314150260348	1	9,25	163
59S/70T10	7314150200313	1	27,74	163
59S/70T10-2P	7314150260355	1	11,11	163
59S/70T15	7314150200566	1	27,74	163
59S/70T15-2P	7314150260362	1	11,11	163
59S/70T20-2P	7314150201839	1	11,11	163
59S/70T20-5P	7314150532131	1	27,74	163
59S/70T25-2P	7314150260379	1	11,11	163
59S/70T25-5P	7314150532155	1	27,74	163
59S/70T27	7314150200597	1	27,74	163
59S/70T27-2P	7314150260386	1	11,11	163
59S/70T30-2P	7314150260393	1	11,11	163
59S/70T30-5P	7314150532179	1	27,74	163
59S/70T40	7314150200610	1	27,74	163
59S/70T40-2P	7314150260409	1	11,11	163
59S/70TR15	7314150200627	1	40,95	164
59S/70TR15-2P	7314150260416	1	16,37	164
59S/70TR20	7314150200634	1	40,95	164
59S/70TR20-2P	7314150260423	1	16,37	164
59S/70TR25	7314150200641	1	40,95	164
59S/70TR25-2P	7314150260430	1	16,37	164
59S/70TR27	7314150200658	1	40,95	164
59S/70TR27-2P	7314150260447	1	16,37	164
59S/70TR30	7314150200665	1	40,95	164
59S/70TR30-2P	7314150260454	1	16,37	164
59S/70TR40	7314150200672	1	40,95	164
59S/70TR40-2P	7314150260461	1	16,37	164
59S/H1.5	7314150198924	1	13,19	161
59S/H1.5-3P	7314150258994	1	7,93	161
59S/H1/16-3P	7314150259021	1	7,93	162
59S/H1/4	7314150199266	1	13,19	162
59S/H1/4-3P	7314150259120	1	7,93	162
59S/H1/8-3P	7314150259069	1	7,93	162
59S/H1/8-5P	7314150532254	1	13,19	162
59S/H10	7314150199075	1	17,17	161
59S/H10-3P	7311518333638	1	10,31	161
59S/H2	7314150198955	1	13,19	161
59S/H2-3P	7314150259007	1	7,93	161
59S/H2.5	7314150198962	1	13,19	161
59S/H2.5-3P	7314150259014	1	7,93	161



59S/H3	7314150198986	1	13,19	161
59S/H3-3P	7314150201662	1	9,53	161
59S/H3/16-3P	7314150259090	1	7,93	162
59S/H3/16-5P	7314150532353	1	13,19	162
59S/H3/32-3P	7314150259045	1	7,93	162
59S/H3/32-5P	7314150532377	1	13,19	162
59S/H3/8	7314150204212	1	7,93	162
59S/H3/8-3P	7314150259144	1	10,31	162
59S/H3BALL	7314150200689	1	40,95	164
59S/H3BALL-2P	7314150260478	1	16,37	164
59S/H4	7314150198993	1	13,19	161
59S/H4-3P	7314150201679	1	9,53	161
59S/H4-IPB	7314150225767	500	0,62	161
59S/H4BALL	7314150200696	1	40,95	164
59S/H4BALL-2P	7314150260485	1	16,37	164
59S/H5	7314150199013	1	13,19	161
59S/H5-3P	7314150201686	1	9,53	161
59S/H5/16-3P	7314150259137	1	7,93	162
59S/H5/16-5P	7314150532438	1	13,19	162
59S/H5/32-3P	7314150259083	1	7,93	162
59S/H5/32-5P	7314150532452	1	13,19	162
59S/H5/64-3P	7314150259038	1	7,93	162
59S/H5/64-5P	7314150532476	1	13,19	162
59S/H5BALL	7314150200702	1	40,95	164
59S/H5BALL-2P	7314150260492	1	16,37	164
59S/H6	7314150199037	1	13,19	161
59S/H6-3P	7314150201693	1	9,53	161
59S/H6BALL	7314150200719	1	40,95	164
59S/H6BALL-2P	7314150260508	1	16,37	164
59S/H7/32-3P	7314150259113	1	7,93	162
59S/H7/32-5P	7314150532513	1	13,19	162
59S/H7/64-3P	7314150259052	1	7,93	162
59S/H7/64-5P	7314150532537	1	13,19	162
59S/H8-3P	7314150201709	1	10,31	161
59S/H8-5P	7314150532551	1	17,17	161
59S/H8BALL	7314150200726	1	40,95	164
59S/H8BALL-2P	7314150260515	1	16,37	164
59S/H9/64-3P	7314150259076	1	7,93	162
59S/HBALL-3P	7314150201716	1	24,51	164
59S/M3	7314150199730	1	34,36	162
59S/M3-3P	7314150259151	1	10,31	162
59S/M4	7314150199754	1	34,36	162
59S/M4-3P	7314150259168	1	10,31	162
59S/M5	7314150199778	1	34,36	162
59S/M5-3P	7314150259175	1	10,31	162
59S/M6	7314150199792	1	34,36	162
59S/M6-3P	7314150259182	1	10,31	162
59S/M8	7314150199808	1	38,31	162
59S/M8-3P	7314150259199	1	11,49	162
59S/PH0	7314150198177	1	6,62	160
59S/PH0-3P	7314150258819	1	2,54	160
59S/PH1-30P	7314150200801	1	18,56	160
59S/PH1-3P	7314150201396	1	3,31	160
59S/PH1-IP	7314150206780	100	0,52	160
59S/PH1-IPB	7314150225743	500	0,47	160
59S/PH1COMBI-2P	7314150215669	1	16,37	164
59S/PH2	7314150198320	1	6,62	160
59S/PH2-30P	7314150200818	1	18,56	160
59S/PH2-3P	7314150201402	1	3,31	160
59S/PH2-IP	7314150206797	100	0,52	160
59S/PH2-IPB	7314150204038	500	0,47	160
59S/PH2COMBI-2P	7314150203604	1	16,37	164
59S/PH2G-30P	7314150200832	1	35,44	160
59S/PH2G-3P	7314150259250	1	3,88	160
59S/PH2PEN	7314150458950	1	3,07	168
59S/PH3-30P	7314150200825	1	18,56	160
59S/PH3-3P	7314150201419	1	3,31	160
59S/PH3-IPB	7314150225750	500	0,47	160
59S/PH3COMBI-2P	7314150203611	1	16,37	164
59S/PH4	7314150198368	1	13,45	160
59S/PH4-3P	7314150258826	1	4,34	160
59S/PZ0	7314150198375	1	8,46	161
59S/PZ0-3P	7314150258833	1	2,54	161
59S/PZ1	7314150198382	1	6,62	161
59S/PZ1-30P	7314150200849	1	18,56	161
59S/PZ1-3P	7314150201426	1	3,31	161
59S/PZ1-IP	7314150206803	100	0,61	161
59S/PZ1-IPB	7314150204373	500	0,47	161
59S/PZ2-30P	7314150200856	1	18,56	161
59S/PZ2-3P	7314150201433	1	3,31	161
59S/PZ2-IP	7314150206810	100	0,52	161
59S/PZ2-IPB	7314150204380	500	0,47	161
59S/PZ2PEN	7314150458974	1	3,07	168
59S/PZ3	7314150198429	1	6,62	161
59S/PZ3-30P	7314150200863	1	18,56	161
59S/PZ3-3P	7314150201440	1	3,31	161
59S/PZ3-IPB	7314150225736	500	0,47	161
59S/PZ4	7314150198436	1	13,45	161
59S/R1	7314150199310	1	29,07	162
59S/R1-3P	7314150201631	1	11,64	162
59S/R2	7314150199341	1	29,07	162
59S/R2-3P	7314150201648	1	11,64	162
59S/R3	7314150199365	1	29,07	162
59S/R3-3P	7314150201655	1	11,64	162
59S/R4	7314150232109	1	29,07	162
59S/T10	7314150198528	1	11,11	161

			€	
59S/T10-30P	7314150200870	1	30,91	161
59S/T10-3P	7314150201457	1	5,55	161
59S/T10CS	7314150444014	1	9,00	161
59S/T15-10P	7314150532759	1	10,00	161
59S/T15-30P	7314150200887	1	30,91	161
59S/T15-3P	7314150201464	1	5,55	161
59S/T15CS	7314150444021	1	9,00	161
59S/T15PEN	7314150458929	1	3,58	168
59S/T20-30P	7314150200894	1	30,91	161
59S/T20-3P	7314150201471	1	5,55	161
59S/T20CS	7314150444038	1	9,00	161
59S/T20PEN	7314150458936	1	3,58	168
59S/T25	7314150198566	1	11,11	161
59S/T25-30P	7314150200900	1	30,91	161
59S/T25-3P	7314150201488	1	5,55	161
59S/T25CS	7314150444045	1	9,00	161
59S/T25PEN	7314150458943	1	3,58	168
59S/T27	7314150198580	1	11,11	161
59S/T27-3P	7314150201495	1	5,55	161
59S/T27CS	7314150444052	1	9,00	161
59S/T3	7314150198443	1	9,26	161
59S/T3-3P	7314150258840	1	5,55	161
59S/T30-10P	7314150251988	1	10,00	161
59S/T30-30P	7314150200924	1	34,49	161
59S/T30-3P	7314150201501	1	7,43	161
59S/T30CS	7314150444069	1	29,72	161
59S/T4	7314150198450	1	9,26	161
59S/T4-3P	7314150258857	1	5,55	161
59S/T40	7314150198610	1	12,38	161
59S/T40-30P	7314150200931	1	34,48	161
59S/T40-3P	7314150201518	1	7,43	161
59S/T40CS	7314150444076	1	29,72	161
59S/T45-3P	7314150258918	1	10,31	161
59S/T45-5P	7314150532971	1	17,17	161
59S/T5	7314150198467	1	9,26	161
59S/T5-3P	7314150258864	1	5,55	161
59S/T50	7314150198658	1	17,17	161
59S/T50-3P	7314150258925	1	10,31	161
59S/T6	7314150198474	1	11,11	161
59S/T6-3P	7314150258871	1	5,55	161
59S/T7	7314150198498	1	11,11	161
59S/T7-3P	7314150258888	1	5,55	161
59S/T8	7314150198504	1	11,11	161
59S/T8-3P	7314150258895	1	5,55	161
59S/T9	7314150198511	1	11,11	161
59S/T9-3P	7314150258901	1	5,55	161
59S/TCS11-1	7314150444083	1	18,48	165
59S/TR10	7314150198702	1	13,62	161
59S/TR10-3P	7314150201525	1	8,17	161
59S/TR15	7314150198719	1	13,62	161
59S/TR15-3P	7314150201532	1	8,17	161
59S/TR20	7314150198726	1	13,62	161
59S/TR20-3P	7314150201549	1	8,17	161
59S/TR25	7314150198740	1	13,62	161
59S/TR25-3P	7314150201556	1	8,17	161
59S/TR27	7314150198757	1	13,62	161
59S/TR27-3P	7314150201570	1	8,17	161
59S/TR30	7314150198771	1	13,62	161
59S/TR30-3P	7314150201587	1	8,17	161
59S/TR40	7314150198795	1	13,62	161
59S/TR40-3P	7314150201594	1	8,17	161
59S/TR7	7314150198672	1	13,62	161
59S/TR7-3P	7314150258932	1	8,17	161
59S/TR8	7314150198689	1	13,62	161
59S/TR8-3P	7314150258949	1	8,17	161
59S/TR9	7314150198696	1	13,62	161
59S/TR9-3P	7314150258956	1	8,17	161
59S/TS-0	7314150199389	1	36,33	162
59S/TS-1	7314150199396	1	36,33	162
59S/TS-1/4	7314150199594	1	36,33	162
59S/TS-10-5P	7314150533138	1	36,33	162
59S/TS-2	7314150199419	1	36,33	162
59S/TS-3	7314150199433	1	36,33	162
59S/TS-4-5P	7314150533152	1	36,33	162
59S/TS-5-5P	7314150533176	1	10,00	162
59S/TS-6-5P	7314150533190	1	36,33	162
59S/TS-8-5P	7314150533220	1	36,33	162
59S/TW0	7314150199617	1	33,03	162
59S/TW1	7314150199631	1	33,03	162
59S/TW2	7314150199655	1	33,03	162
59S/TW3	7314150199679	1	33,03	162
59S/TW4	7314150199693	1	33,03	162
59S/TW5	7314150199716	1	33,03	162
6	8412814220048	1	17,61	218
6-342-06-2-0	7311518021719	10	8,67	30
6-342-06-2-2	7311518244170	5	12,06	30
6-342-08-1-0	7311518021726	10	10,01	30
6-342-08-1-2	7311518028282	5	13,53	30
6-342-08-2-0	7311518021733	10	11,64	30
6-342-08-2-2	7311518005375	5	16,25	30
6-342-10-1-0	7311518021757	10	13,67	30
6-342-10-1-2	7311518005382	5	16,80	30
6-342-10-2-0	7311518021764	10	14,75	30
6-342-10-2-2	7311518005399	5	19,91	30
6-343-08-2-0	7311518021801	10	15,42	30
6-343-08-2-2	7311518001070	5	17,95	30

			€	
6-343-08-3-0	7311518021818	10	17,60	30
6-343-10-2-0	7311518021825	10	19,63	30
6-343-10-2-2	7311518001094	5	21,94	30
6-343-10-3-0	7311518021832	10	22,48	30
6-344-08-2-0	7311518021887	10	10,47	30
6-344-08-2-2	7311518005344	5	14,48	30
6-344-10-2-0	7311518021900	10	11,86	30
6-344-10-2-2	7311518005351	5	17,60	30
6-345-08-1-2	7311518028312	5	10,91	31
6-345-08-2-0	7311518021948	10	9,59	31
6-345-08-2-2	7311518005412	5	11,13	31
6-345-10-1-2	7311518005429	5	13,81	31
6-345-10-2-0	7311518021955	10	11,60	31
6-470-08-2-2	7311518242008	5	53,47	31
600-3	7314150124787	1	12,84	208
600.003.010	8412814600000	1	30,35	372
600.005.012	8412814600017	1	39,20	372
601000800	8413345202299	1	239,10	589
601001000	8413345202305	1	318,78	589
601001250	8413345202312	1	439,07	589
601001500	8413345202329	1	624,07	589
6010H0800	8413345015769	1	48,68	590
6010H1000	8413345015776	1	57,91	590
6010H1250	8413345015783	1	78,95	590
6010H1500	8413345015790	1	134,26	590
6010M0800	8413345015806	1	24,82	589
6010M1000	8413345116619	1	25,42	589
6010M1250	8413345015820	1	37,59	589
6010M1500	8413345015837	1	46,01	589
601A	7314150476282	5	193,56	654
602-4-LA	7314150224357	1	18,10	208
604-5	7314150124800	1	24,05	208
6040M0630	8413345124126	1	20,76	590
605-10-PC-AU	7314150186334	1	56,12	209
605-6	7314150153770	1	29,23	209
606-6	7314150124824	1	28,28	209
6070H1000	8413345030656	1	43,74	589
6070H1250	8413345084833	1	62,25	589
6070H1500	8413345030663	1	111,28	589
6070H1750	8413345030670	1	143,14	589
607201000	8413345030533	1	248,11	589
607201250	8413345030540	1	347,35	589
607201500	8413345030557	1	446,59	589
607201750	8413345030564	1	595,46	589
6072M1000	8413345015813	1	29,63	589
6072M1500	8413345137454	1	45,95	589
6072M1750	8413345030687	1	56,70	589
60T/17-1	7314150191529	1	28,88	158
60T/31-1	7314150191482	1	37,78	158
60T/7-1	7314150191574	1	17,59	158
60T/PH1	7314150199488	1	10,86	158
60T/PH2	7314150199495	1	10,86	158
60T/PH3	7314150199501	1	10,86	158
60T/PZ1	7314150199525	1	10,86	158
60T/PZ2	7314150199549	1	10,86	158
60T/PZ3	7314150199563	1	10,86	158
60T/T15	7314150199662	1	16,88	158
60T/T20	7314150199686	1	16,88	158
60T/T25	7314150199709	1	16,88	158
60T/T27	7314150199723	1	16,88	158
60T/T40	7314150199761	1	16,88	158
60T/T7	7314150199587	1	16,88	158
60T/T9	7314150199624	1	16,88	158
610-6	7314150124848	1	29,09	209
611-10-200	7314150124428	10	10,25	210
611-3.5-100	7314150124336	10	3,26	210
611-3.5-75	7314150124329	10	3,11	210
611-4-100	7314150124350	10	4,15	210
611-4-75	7314150124343	10	3,72	210
611-5.5-100	7314150124367	10	4,95	210
611-5.5-125	7314150124381	10	5,22	210
611-6.5-125	7314150124374	10	6,31	210
611-6.5-150	7314150124398	10	6,61	210
611-6.5-25	7314150124602	10	6,29	210
611-8-150	7314150124404	10	8,02	210
611-8-175	7314150124411	10	8,49	210
612-5	7314150124817	1	28,87	208
613-3-100	7314150124442	10	3,16	210
613-3-75	7314150124435	10	3,10	210
613-3.5-100	7314150124459	10	3,27	210
613-4-100	7314150124466	10	3,67	210
613-4-125	7314150124473	10	4,05	210
613-5.5-150	7314150124497	10	5,42	210
613-6.5-150	7314150124503	10	6,86	210
614A	7314150476305	5	167,22	654
615-0-75	7314150124558	10	3,40	210
615-1-100	7314150124565	10	4,97	210
615-2-125	7314150124572	10	6,41	210
615-2-25	7314150124596	10	6,29	210
615-3-150	7314150124589	10	9,74	210
6151	7314150539185	10	22,99	652
6152	7314150539192	10	23,90	652
6152SS	7314150539215	10	27,90	652
6159	7314150539208	10	27,90	653
616-0-75	7314150124510	10	4,42	210
616-1-100	7314150124527	10	5,35	210





616-2-125	7314150124534	10	6,88	210
616-3-150	7314150124541	10	10,32	210
618-10-75	7314150124619	10	5,15	210
618-15-100	7314150124626	10	5,42	210
618-20-100	7314150124633	10	5,42	210
618-25-125	7314150124640	10	6,29	210
618-27-125	7314150124657	10	6,29	210
618-30-150	7314150124664	10	7,74	210
618-40-150	7314150124671	10	8,79	210
61H/50PH1	7314150200382	1	14,72	159
61H/50PZ1	7314150200412	1	14,72	159
61H/50PZ2	7314150200429	1	14,72	159
61H/50PZ3	7314150200436	1	14,72	159
61H/50T10	7314150200443	1	18,68	159
61H/50T15	7314150200450	1	18,68	159
61H/50T25	7314150200474	1	18,68	159
61H/50T30	7314150200481	1	18,68	159
61H/PH1	7314150199006	1	11,58	158
61H/PH2	7314150199020	1	11,58	158
61H/PH3	7314150199044	1	5,79	158
61H/PZ3	7314150199105	1	5,79	159
61H/T10	7314150199129	1	17,83	159
61H/T15	7314150199143	1	17,83	159
61H/T20	7314150199167	1	17,83	159
61H/T25	7314150199181	1	17,83	159
61H/T40	7314150199235	1	8,93	159
620-6	7314150128594	1	49,54	497
622-3P	7314150427727	1	91,68	248
6221D	7314150421596	10	20,86	248
6221D IP	7314150440368	10	20,50	248
6222D	7314150421589	10	22,17	248
6222D IP	7314150437702	10	21,78	248
6223D	7314150421558	8	22,66	248
6223D IP	7314150421794	8	22,30	248
6224	7314150421619	4	32,19	247
6224D	7314150421565	5	20,27	248
6224D IP	7314150421800	5	19,88	248
6225D	7314150421572	10	35,79	248
6225D IP	7314150421817	5	35,38	248
623-3-100	7314150128518	10	5,90	497
623-3.5-100	7314150128525	10	6,42	497
623-4-100	7314150128532	10	6,70	497
623-5-5-125	7314150128549	10	9,30	497
623-6.5-150	7314150128556	10	11,08	497
625	7311518221614	5	30,10	548
625-0-100	7314150128563	10	4,12	497
625-1-150	7314150128570	10	7,67	497
625-2-175	7314150128587	10	10,68	497
625-DROP	7311518221638	10	13,30	548
625-PEAR	7311518221621	10	13,30	548
625-ROUND	7311518221645	10	13,30	548
6258	7314150539222	10	27,90	653
62TIN/50PH1	7314150200504	1	22,30	157
62TIN/50PH3	7314150200528	1	22,30	157
62TIN/50PZ1	7314150200535	1	22,30	157
62TIN/50PZ2	7314150200542	1	22,30	157
62TIN/50PZ3	7314150200559	1	22,30	157
62TIN/7-1	7314150203505	1	22,95	157
62TIN/PH1	7314150199259	1	20,51	157
62TIN/PZ1	7314150199327	1	20,51	157
62TIN/PZ2	7314150199334	1	20,51	157
62TIN/PZ3	7314150199358	1	20,51	157
62TIN/T15	7314150199402	1	25,32	157
62TIN/T20	7314150199426	1	25,32	157
62TIN/T25	7314150199440	1	25,32	157
62TIN/T30	7314150199464	1	25,32	157
63D/50PZ1	7314150200320	1	26,53	157
63D/50PZ2	7314150200337	1	26,53	157
63D/50PZ3	7314150200344	1	26,53	157
63D/7-1	7314150191604	1	28,85	157
63D/PH2G	7314150198979	1	19,90	156
63D/PH3	7314150198948	1	16,88	156
63D/PZ1	7314150198856	1	16,88	156
63D/PZ2	7314150198870	1	16,88	156
63D/T10	7314150198665	1	19,30	156
63D/T15	7314150198733	1	19,30	156
63D/T40	7314150198832	1	19,30	156
64A/PH1	7314150198481	1	14,95	157
64A/PH3	7314150198573	1	14,95	157
64A/PZ1	7314150198603	1	14,95	158
64A/PZ3	7314150198634	1	14,95	158
650	7311518221591	5	29,42	548
65I/7-1	7314150204113	1	26,36	529
65I/PH1	7314150199785	1	28,05	529
65I/PH1-2P	7314150207985	1	6,62	529
65I/PH2	7314150199884	1	28,05	529
65I/PH2-2P	7314150201259	1	6,62	529
65I/PH3	7314150199907	1	28,05	529
65I/PH3-2P	7314150201266	1	6,62	529
65I/PZ1	7314150199921	1	28,05	529
65I/PZ1-2P	7314150201273	1	6,62	529
65I/PZ2	7314150199945	1	28,05	529
65I/PZ2-2P	7314150201280	1	6,62	529
65I/PZ3	7314150199969	1	28,05	529
65I/PZ3-2P	7314150201297	1	6,62	529
65I/T15	7314150199990	1	16,04	529



65I/T25	7314150200030	1	15,27	529
65I/T30	7314150200054	1	15,27	529
65I/T40	7314150200078	1	16,04	529
65I/T40-2P	7314150201358	1	7,29	529
665	7311518221607	5	42,59	548
66M/10C-1	7314150450732	1	22,11	160
66M/11C-1	7314150450718	1	17,68	160
66M/50PH1-2P	7314150446056	1	3,88	159
66M/50PH2-2P	7314150446063	1	3,88	159
66M/50PH3-2P	7314150446087	1	3,88	159
66M/50PZ1-2P	7314150446094	1	3,88	160
66M/50PZ2-2P	7314150446100	1	3,88	160
66M/50PZ3-2P	7314150446117	1	3,88	160
66M/50T10C-2P	7314150446131	1	3,93	160
66M/50T15C-2P	7314150446148	1	3,93	160
66M/50T20C-2P	7314150446155	1	3,93	160
66M/50T25C-2P	7314150446162	1	3,93	160
66M/50T27C-2P	7314150446179	1	3,93	160
66M/50T30C-2P	7314150446186	1	3,93	160
66M/50T40C-2P	7314150446193	1	3,93	160
66M/PH1-2P	7314150445929	1	3,05	159
66M/PH2-2P	7314150445936	1	3,05	159
66M/PH3-2P	7314150445943	1	3,05	159
66M/PZ1-2P	7314150445950	1	3,05	159
66M/PZ2-2P	7314150445967	1	3,05	159
66M/PZ3-2P	7314150445974	1	3,05	159
66M/T10C-2P	7314150445981	1	3,14	159
66M/T15C-2P	7314150445998	1	3,14	159
66M/T20C-2P	7314150446001	1	3,14	159
66M/T25C-2P	7314150446018	1	3,14	159
66M/T27C-2P	7314150446025	1	3,14	159
66M/T30C-2P	7314150446032	1	3,14	159
66M/T40C-2P	7314150446049	1	3,14	159
6700SM-10	7314151088026	5	5,13	78
6700SM-11	7314151088033	5	5,13	78
6700SM-12	7314151088040	5	5,13	78
6700SM-13	7314151088057	5	5,13	78
6700SM-14	7314151088064	5	5,13	78
6700SM-4	7314151087944	5	5,13	78
6700SM-4.5	7314151087951	5	5,13	78
6700SM-5	7314151087968	5	5,13	78
6700SM-5.5	7314151087975	5	5,13	78
6700SM-6	7314151087982	5	5,13	78
6700SM-7	7314151087999	5	5,13	78
6700SM-8	7314151088002	5	5,13	78
6700SM-9	7314151088019	5	5,13	78
6700SZ-1/2	7314151088194	5	5,21	78
6700SZ-1/4	7314151088132	5	5,21	78
6700SZ-1/8	7314150346349	5	5,21	78
6700SZ-11/32	7314151088163	5	5,21	78
6700SZ-3/16	7314151088118	5	5,21	78
6700SZ-3/8	7314151088170	5	5,21	78
6700SZ-5/16	7314151088156	5	5,21	78
6700SZ-5/32	7314151808556	5	5,21	78
6700SZ-7/16	7314151088187	5	5,21	78
6700SZ-7/32	7314151088125	5	5,21	78
6700SZ-9/16	7314151088200	5	5,21	78
6700SZ-9/32	7314151088149	5	5,21	78
6700TORX-E10	7314153011725	5	6,87	78
6700TORX-E4	7314153011671	5	6,87	78
6700TORX-E5	7314153011688	5	6,87	78
6700TORX-E6	7314153011695	5	6,87	78
6700TORX-E7	7314153011701	5	6,87	78
6700TORX-E8	7314153011718	5	6,87	78
6706TE	7314150220199	1	47,00	69
6708DMB	7314150220205	1	94,59	69
6709-IP10	7314150354498	1	8,77	83
6709-IP15	7314150354504	1	8,77	83
6709-IP20	7314150354511	1	8,77	83
6709-IP25	7314150354528	1	9,10	83
6709-IP27	7314150354535	1	8,77	83
6709-IP30	7314150354542	1	8,39	83
6709-IP40	7314150354559	1	10,46	83
6709-IP45	7314150354566	1	10,46	83
6709-IP6	7314150460373	1	8,39	83
6709-IP7	7314150460366	1	8,39	83
6709-IP8	7314150460359	1	8,71	83
6709-IP9	7314150460342	1	8,71	83
6709F-4.5	7314151830762	5	6,81	82
6709F-5.5	7314151830779	5	6,81	82
6709F-6.5	7314150220397	5	6,81	82
6709F-8	7314151830786	5	6,81	82
6709HL	7314150128457	1	9,70	81
6709M-10	7314150430833	5	6,73	83
6709M-3	7314151830656	5	6,74	83
6709M-4	7314151830663	5	6,74	83
6709M-5	7314151830670	5	6,74	83
6709M-6	7314151830687	5	6,74	83
6709M-8	7314151830694	5	6,74	83
6709PH-1	7314151830700	5	7,45	82
6709PH-2	7314151830717	5	7,45	82
6709PH-3	7314151830724	5	7,45	82
6709PZ-1	7314151830731	5	7,91	82
6709PZ-2	7314151830748	5	7,91	82
6709PZ-3	7314151830755	5	7,91	82
6709TORX-R-T10	7314153002471	1	8,79	83



6709TORX-R-T15	7314153002488	1	8,79	83
6709TORX-R-T20	7314153002495	1	8,79	83
6709TORX-R-T25	7314153002501	1	9,11	83
6709TORX-R-T8	7314153002464	1	8,79	83
6709TORX-T10	7314151811679	5	8,39	83
6709TORX-T15	7314151811686	5	8,39	83
6709TORX-T20	7314151811693	5	8,39	83
6709TORX-T25	7314151811709	5	8,67	83
6709TORX-T27	7314151811716	5	8,67	83
6709TORX-T30	7314151811723	5	8,67	83
6709TORX-T40	7314153002457	5	8,67	83
6709TORX-T6	7314150460540	5	8,09	83
6709TORX-T7	7314150460557	5	8,09	83
6709TORX-T8	7314153002440	5	8,39	83
6709TORX-T9	7314151811662	5	8,39	83
671002600	8413345128971	50	148,67	553
671002850	8413345128988	1	113,57	553
6711MB	7314150220298	1	59,75	69
6712R	7314151838225	1	125,40	65
6712RN	7314151838232	1	120,37	65
6713MH	7314150220212	1	68,64	68
6715GE	7314151831370	1	223,49	67
6715GJ	7314151831363	1	256,16	67
6715MG	7314151831349	1	205,49	66
6715MGS	7314151831332	1	166,88	65
6715MZ	7314153003218	1	206,86	68
6715PZ	7314151837525	1	255,22	67
6717MBP	7314150218806	1	173,99	66
6719MHR	7314150218783	1	179,64	65
6719SM	7314151820817	1	170,20	66
6720NM	7314151088262	1	311,37	67
6721NM	7314151088309	1	278,06	66
6722M	7314151594411	1	226,83	67
6729MHP	7314150218752	1	193,09	66
6729MHR	7314150218769	1	189,76	65
6729SM	7314153003225	1	79,67	68
6729SZ	7314153003232	1	53,26	68
6730MBP	7314150218776	1	197,59	66
677-10	7314150362486	1	32,63	51
677-13	7314150362493	1	32,63	51
677-3/8	7314150362509	1	32,28	51
677-7	7314150362455	1	32,63	51
677-8	7314150362462	1	32,63	51
677-9	7314150362479	1	32,63	51
679-1/2	7314150363384	1	42,86	54
679-10	7314150357345	1	50,06	54
679-11	7314150357352	1	45,02	54
679-12	7314150357369	1	50,47	54
679-13	7314150357376	1	50,71	54
679-14	7314150357383	1	54,60	54
679-3/8	7314150363360	1	42,86	54
679-7	7314150357536	1	45,02	54
679-7/16	7314150363377	1	42,86	54
679-8	7314150357079	1	45,02	54
679-9	7314150357338	1	45,97	54
679-9/16	7314150363391	1	42,86	54
6821NZ	7314151089269	1	269,96	68
6852-5	7314150125463	1	271,19	111
6852-5/S17	7314150135875	1	297,67	112
6852P-5	7314150416585	1	305,38	112
6876N	7314151845575	1	273,57	112
6878N	7314151845582	1	280,40	112
6880N	7314151845599	1	310,60	112
690000160	8413345008068	1	60,64	610
690000200	8413345008082	1	76,02	610
690000220	8413345008099	1	76,02	610
690000250	8413345008105	1	86,33	610
690000300	8413345008129	1	93,45	610
690000320	8413345008136	1	93,45	610
690000350	8413345008143	1	119,67	610
690000400	8413345008143	1	128,29	610
690000500	8413345008167	1	157,43	610
690000630	8413345111065	1	364,89	610
69079019P	8413345111089	1	986,68	610
690900080	8413345016209	4	12,66	610
690900100	8413345016216	4	18,69	610
690900120	8413345016223	2	18,69	610
690900140	8413345016230	2	27,88	610
690900200	8413345016247	1	55,09	610
6950	7314151089641	1	40,82	84
6950-SPARE	7314150187867	1	18,13	85
6950RN	7314151831189	1	36,99	84
6950RN-SPARE	7314150209149	1	17,41	85
6950SL	7314150197668	1	41,21	84
6950SL-SPARE	7314150210251	1	17,63	85
6951	7314151089764	1	80,43	84
6954	7314151089795	1	11,63	80
6956	7314151089825	10	12,02	80
6958-6	7314150476329	1	21,58	80
6960	7314151089856	1	8,98	81
6960-3	7314150489381	10	9,27	81
6960F-6	7314150489206	20	9,86	81
6960W-2	7314150470860	10	11,02	81
6960W-4	7314150470877	1	12,86	81
6960W-6	7314150470884	10	14,70	81
6961	7314151089870	1	10,43	81



6962	7314151089894	1	12,46	81
6962L	7314151089917	1	29,85	81
6966	7314151089986	10	23,63	81
6968	7314150128426	1	30,09	81
6969	7314150489268	1	1,34	82
696EX-01	7314150386192	1	7,71	81
696EX-06	7314150386239	1	9,30	81
696EX-08	7314150386246	1	12,82	81
696EX-11	7314150386208	1	14,14	81
6972H	7314151215934	5	22,59	81
6973A	7314150339495	10	7,29	82
6973M	7314150339501	1	6,69	81
6973N	7314151845605	1	297,00	111
6976N	7314151845612	1	303,90	111
6978N	7314151845629	1	310,61	111
6M-10-11	7314151832094	10	5,96	48
6M-10-13	7314151832117	10	7,32	48
6M-12-13	7314151832131	10	7,25	48
6M-12-14	7314151832148	10	7,76	48
6M-13-14	7314151832155	10	7,69	48
6M-13-15	7314151832162	10	8,53	48
6M-13-16	7314151832179	10	9,24	48
6M-13-17	7314151832186	10	9,07	48
6M-14-15	7314151832193	10	7,69	48
6M-14-17	7314151832209	10	8,92	48
6M-16-17	7314151832216	10	8,92	48
6M-16-18	7314151832223	10	9,76	48
6M-17-19	7314151832230	10	10,05	48
6M-18-19	7314151832247	10	10,05	48
6M-19-22	7314151832261	10	12,16	48
6M-19-24	7314151832278	10	12,90	48
6M-20-22	7314151832285	10	11,91	48
6M-21-23	7314151832292	10	12,98	48
6M-21-24	7314151838072	10	14,33	48
6M-22-24	7314151832308	10	12,96	48
6M-24-26	7314151832315	10	15,08	48
6M-24-27	7314151832322	10	15,37	48
6M-24-30	7314151832339	5	17,79	48
6M-25-28	7314151832353	5	17,52	48
6M-27-29	7314150189861	5	20,86	48
6M-27-30	7314151832360	5	21,77	48
6M-27-32	7314151832377	5	23,82	48
6M-30-32	7314151832384	5	23,52	48
6M-30-36	7314151832407	5	39,16	48
6M-32-36	7314151832414	5	41,17	48
6M-34-36	7314151832421	1	43,22	48
6M-36-41	7314151832438	1	46,93	48
6M-38-42	7314151832445	1	55,80	48
6M-4-5	7314151832018	10	5,44	48
6M-4-5-5-5	7314151832025	10	6,97	48
6M-41-46	7314151832452	1	66,05	48
6M-46-50	7314151832469	1	86,11	48
6M-5-5-5	7314151832032	10	7,04	48
6M-5-5-7	7314151832049	10	5,45	48
6M-6-7	7314151832056	10	5,45	48
6M-7-8	7314151832063	10	5,78	48
6M-8-10	7314151832087	10	5,89	48
6M-8-9	7314151832070	10	5,48	48
6M/10C	7314150212934	1	93,07	50
6M/12C	7314150212941	1	135,38	50
6M/6C	7314150212910	1	41,81	50
6M/8C	7314150212927	1	64,30	50
6M/S8	7314151832483	1	63,08	49
6M/SH12	7314153013439	1	144,95	49
6M/SH8	7314150201365	1	78,45	49
6MV-10	7314150120871	5	23,48	501
6MV-11	7314150120888	5	23,63	501
6MV-12	7314150120895	5	24,81	501
6MV-13	7314150120901	5	26,07	501
6MV-14	7314150120918	5	26,07	501
6MV-15	7314150120925	5	25,96	501
6MV-16	7314150120932	5	27,35	501
6MV-17	7314150120949	3	27,86	501
6MV-18	7314150120956	3	28,50	501
6MV-19	7314150120963	3	29,57	501
6MV-20	7314150120970	3	31,01	501
6MV-21	7314150120987	3	33,43	501
6MV-22	7314150120994	3	34,88	501
6MV-23	7314150121007	3	38,87	501
6MV-24	7314150121014	3	40,35	501
6MV-27	7314150121021	2	46,52	501
6MV-30	7314150121038	2	51,87	501
6MV-32	7314150121052	2	53,14	501
6MV-6	7314150120833	5	24,09	501
6MV-7	7314150120840	5	24,41	501
6MV-8	7314150120857	5	22,18	501
6MV-9	7314150120864	5	23,21	501
6MV/10T	7314150213023	1	282,64	504
6MV/8T	7314150122141	1	210,84	504
6Z-1-1-1/8	7314151832674	1	17,99	49
6Z-1.1/16-1.1/4	7314151832681	1	23,83	49
6Z-1.1/4-1.3/8	7314151832698	1	41,36	49
6Z-1/2-9/16	7314151832568	5	7,91	49
6Z-1/4-5/16	7314151832520	5	5,59	49
6Z-11/16-3/4	7314151832612	5	10,30	49
6Z-13/16-7/8	7314151832643	5	12,28	49





6Z-15/16-1	7314151832667	5	15,53	49
6Z-19/32-11/16	7314151832582	5	9,92	49
6Z-25/32-13/16	7314151832636	5	14,18	49
6Z-3/4-7/8	7314151832629	5	12,28	49
6Z-3/8-7/16	7314151832544	5	6,25	49
6Z-5/16-11/32	7314151832537	5	5,59	49
6Z-5/8-3/4	7314151832605	5	10,30	49
6Z-7/16-1/2	7314151832551	5	7,47	49
6Z-7/8-15/16	7314151832650	5	15,88	49
6Z-9/16-5/8	7314151832575	5	7,91	49
6Z/8C	7314150212958	1	74,83	50
700-1-50	7314153017673	5	7,67	213
700-1.2-50	7314153017680	5	7,67	213
700-1.5-50	7314153017697	5	7,67	213
700-1.8-50	7314153017703	5	7,67	213
700-2-50	7314153017710	5	6,71	213
700-2.5-50	7314153017741	5	6,71	213
700-3-100	7314153017772	5	6,42	213
700-3-200	7314153017789	5	7,38	213
700-3-50	7314153017765	5	6,42	213
700-3.5-75	7314153017796	5	6,71	213
700-4-250	7314153017819	5	8,66	213
700-4-75	7314153017802	5	6,95	213
701-0-200	7314153017857	5	8,44	214
701-0-50	7314153017840	5	6,71	214
701-00-50	7314153017833	5	7,96	214
701-1-250	7314153017871	5	7,97	214
701-1-75	7314153017864	5	7,51	214
702-0-50	7314153017888	5	7,56	214
702-1-75	7314153017895	5	8,04	214
703-10-50	7314153017963	5	7,35	214
703-15-75	7314153017970	5	7,35	214
703-20-75	7314153017987	5	7,35	214
703-4-50	7314153017901	5	9,18	214
703-5-50	7314153017918	5	9,18	214
703-6-50	7314153017925	5	7,35	214
703-7-50	7314153017932	5	7,35	214
703-8-50	7314153017949	5	7,35	214
703-9-50	7314153017956	5	7,35	214
704-1.5-50	7314153017994	5	8,44	214
704-2-50	7314153018007	5	8,44	214
704-2.5-50	7314153018014	5	8,44	214
704-3-75	7314153018021	5	8,44	214
704Z-3/32	7314150137428	5	8,43	214
706-1	7314153018045	1	45,66	212
706-2	7314153018052	1	47,60	212
706-3	7314153018069	1	47,60	213
706-4	7314153018076	1	53,63	213
706-5	7314153018083	1	181,59	213
70S/1.2-8.0-2P	7314150262823	1	8,38	168
70S/1.6-10.0	7314150218394	1	29,75	168
70S/1.6-10.0-2P	7314150261017	1	11,90	168
70S/1.6-9.0	7314150218400	1	20,95	168
70S/1.6-9.0-2P	7314150261024	1	8,38	168
70S/2.0-12.0	7314150218417	1	32,51	169
70S/2.0-12.0-2P	7314150261086	1	13,00	169
70S/2.5-14.0	7314150218424	1	36,68	169
70S/2.5-14.0-2P	7314150261147	1	14,68	169
70S/H10	7314150218486	1	22,26	169
70S/H10-2P	7314150261451	1	8,90	169
70S/H12	7314150218493	1	23,71	169
70S/H12-2P	7314150261468	1	9,47	169
70S/H14	7314150218509	1	23,71	169
70S/H14-2P	7314150261475	1	9,47	169
70S/H4	7314150218431	1	18,41	169
70S/H4-2P	7314150261352	1	7,37	169
70S/H5	7314150218448	1	18,41	169
70S/H5-2P	7314150261406	1	7,37	169
70S/H6	7314150218455	1	18,41	169
70S/H6-2P	7314150261437	1	7,37	169
70S/H7	7314150218462	1	18,41	169
70S/H7-2P	7314150261444	1	7,37	169
70S/H8-5P	7314150538782	1	8,72	169
70S/H8-2P	7314150262847	1	7,37	169
70S/PH1	7314150217557	1	18,41	169
70S/PH1-2P	7314150260621	1	7,37	169
70S/PH2	7314150217564	1	18,41	169
70S/PH2-2P	7314150260638	1	7,37	169
70S/PH3	7314150217571	1	18,41	169
70S/PH3-2P	7314150260645	1	7,37	169
70S/PH4	7314150217588	1	18,41	169
70S/PH4-2P	7314150260652	1	7,37	169
70S/PZ1	7314150217595	1	18,41	169
70S/PZ1-2P	7314150260683	1	7,37	169
70S/PZ2	7314150217601	1	18,41	169
70S/PZ2-2P	7314150260706	1	7,37	169
70S/PZ3	7314150217724	1	18,41	169
70S/PZ3-2P	7314150260720	1	7,37	169
70S/PZ4	7314150217731	1	18,41	169
70S/PZ4-2P	7314150260737	1	7,37	169
70S/T20	7314150217748	1	23,08	169
70S/T20-2P	7314150260744	1	9,23	169
70S/T25-2P	7314150260812	1	9,23	169
70S/T25-5P	7314150538508	1	23,08	169
70S/T27-5P	7314150538522	1	10,75	169
70S/T27-2P	7314150260867	1	9,23	169



70S/T30	7314150217779	1	23,08	169
70S/T30-2P	7314150260881	1	9,23	169
70S/T40-2P	7314150260898	1	9,23	169
70S/T45	7314150217793	1	23,08	169
70S/T45-2P	7314150260904	1	9,23	169
70S/T50	7314150217809	1	23,08	169
70S/T50-2P	7314150260911	1	9,23	169
70S/T55	7314150217816	1	31,94	169
70S/T55-2P	7314150260928	1	12,76	169
70S/TS1/4	7314150218349	1	38,46	169
70S/TS1/4-2P	7314150260935	1	15,38	169
70S/TS10	7314150218356	1	43,13	169
70S/TS10-2P	7314150260942	1	17,25	169
70S/TS5/16	7314150218363	1	43,13	169
70S/TS5/16-2P	7314150260959	1	17,25	169
70S/TS8	7314150218370	1	43,13	169
70S/TS8-2P	7314150260966	1	17,25	169
7106J	7314150339518	1	8,53	88
7154TC	7314150475148	10	226,53	649
7190	7314150052479	10	61,47	644
7190 CO	7314150052790	10	67,82	644
7191	7314150052509	10	59,47	644
7191 CO	7314150052806	10	72,90	644
7223	7314150237722	4	33,32	247
7223D	7314150421527	8	32,19	247
7223D IP	7314150440306	8	31,00	247
7223IP	7314150421855	8	31,59	247
7224	7311518274733	4	34,43	247
7224-622XD-3P	7314150426973	1	88,03	249
7224IP	7314150421831	4	32,79	247
7224S	7314150421657	4	39,34	501
7225	7314150237739	8	43,35	247
7225D	7314150421541	4	42,33	247
7225D IP	7314150440320	4	41,37	247
7225IP	7314150421848	4	41,72	247
7280	7314150052523	10	74,93	647
7285	7314150052530	10	82,28	647
7290	7314150052547	10	68,21	645
7291	7314150052554	10	71,83	645
7292	7314150052578	10	45,06	646
7292G	7314150434701	10	125,54	648
7293	7314150052592	10	81,83	646
7372I-2-63	7314151398668	10	13,17	218
7372I-2.5-75	7314151399047	10	13,17	218
7372I-3-80	7314151341602	10	13,17	218
7400SM-10	7314151092955	5	6,12	85
7400SM-11	7314151092962	5	6,20	85
7400SM-12	7314151092979	5	6,29	85
7400SM-13	7314151092986	5	6,45	85
7400SM-14	7314151092993	5	6,89	85
7400SM-15	7314151093006	5	7,16	85
7400SM-16	7314151831127	5	7,56	85
7400SM-17	7314151093020	5	7,74	85
7400SM-18	7314151831134	5	7,92	85
7400SM-19	7314151093044	5	8,24	85
7400SM-20	7314153002570	5	8,46	85
7400SM-21	7314153002587	5	8,71	85
7400SM-22	7314153002594	5	8,85	85
7400SM-6	7314151092917	5	5,58	85
7400SM-7	7314151092924	5	5,58	85
7400SM-8	7314151092931	5	5,68	85
7400SM-9	7314151092948	5	5,90	85
7400SR/S12	7314153003294	1	82,22	71
7400SZ-1/2	7314150385942	1	7,34	85
7400SZ-1/4	7314150385959	1	7,22	85
7400SZ-11/16	7314150385966	1	7,45	85
7400SZ-11/32	7314150385973	1	7,45	85
7400SZ-13/16	7314150385980	1	7,45	85
7400SZ-3/4	7314150385997	1	7,45	85
7400SZ-3/8	7314150386000	1	7,22	85
7400SZ-5/16	7314150386017	1	7,22	85
7400SZ-5/8	7314150386024	1	7,45	85
7400SZ-7/16	7314150386031	1	7,34	85
7400SZ-7/8	7314150386048	1	7,45	85
7400SZ-9/16	7314150386055	1	7,34	85
7400TORX-E10	7314153003058	5	10,88	86
7400TORX-E11	7314153003065	5	10,88	86
7400TORX-E12	7314153003072	5	10,88	86
7400TORX-E14	7314153003089	5	11,89	86
7400TORX-E16	7314153003096	5	11,89	86
7400TORX-E18	7314153003102	5	12,48	86
7400TORX-E8	7314150118243	5	10,88	86
7400TORX-ER/S7	7314153003300	1	80,21	71
7402GPR-16	7314150503087	120	2,94	307
7402GPR-18	7314150503094	120	5,05	307
7402GPR-21	7314150503100	100	3,46	307
7406ZZ-16	7314153011992	1	31,97	307
7406ZZ-21	7314153012005	1	31,97	307
7407H	7314151218249	1	25,23	173
7408H	7314151218300	1	25,23	173
7408MD	7314150220328	1	118,13	71
7409BH-10	7314153002112	5	14,01	90
7409BH-4	7314153002075	5	11,40	90
7409BH-5	7314153002082	1	11,40	90
7409BH-6	7314153002099	5	11,40	90
7409BH-8	7314153002105	5	12,36	90

			€	
7409F-10	7314153002143	5	6,54	89
7409F-6.5	7314153002129	5	6,54	89
7409F-8	7314153002136	5	6,54	89
7409H	7314151218355	1	29,24	173
7409M-10	7314153001962	5	11,63	90
7409M-3	7314153002235	5	10,62	90
7409M-4	7314153001900	5	10,62	90
7409M-5	7314153001917	5	10,62	90
7409M-6	7314153001924	5	10,62	90
7409M-7	7314153001931	5	10,62	90
7409M-8	7314153001948	5	11,63	90
7409MB	7314150220236	1	69,49	71
7409MR/S7	7314153003256	1	77,17	90
7409PH-1	7314153002150	5	6,89	89
7409PH-2	7314153002167	5	6,89	89
7409PH-3	7314153002174	5	6,89	89
7409TORX-R-T27	7314153001856	5	13,00	89
7409TORX-R-T30	7314153001863	5	13,00	89
7409TORX-R-T40	7314153001870	5	15,29	89
7409TORX-R-T45	7314153001887	5	15,60	89
7409TORX-R-T50	7314153001894	5	16,23	89
7409TORX-T20	7314150220403	5	11,72	89
7409TORX-T25	7314153001771	5	11,72	89
7409TORX-T25-L	7314153011237	5	19,05	90
7409TORX-T27	7314153001788	5	11,72	89
7409TORX-T30	7314153001795	5	11,72	89
7409TORX-T30-L	7314153011244	5	19,05	90
7409TORX-T40	7314153001801	5	14,21	89
7409TORX-T40-L	7314153011251	5	22,28	90
7409TORX-T45	7314153001818	5	14,21	89
7409TORX-T45-L	7314153011268	5	22,28	90
7409TORX-T50	7314153001825	5	14,21	89
7409TORX-T50-L	7314153011275	5	22,28	90
7409TORX-TRR/S5	7314153003263	1	70,25	89
7409Z-1/4	7314150386062	1	9,57	90
7409Z-1/8	7314150386079	1	9,57	90
7409Z-3/16	7314150386086	1	9,57	90
7409Z-3/8	7314150386093	1	10,48	90
7409Z-5/32	7314150386109	1	9,57	90
7409Z-7/32	7314150386116	1	9,57	90
7422MBR	7314150218844	1	248,73	71
7422MHR	7314150218868	1	241,85	71
7444SG-M-100	7314151830014	1	474,87	55
7444SG-M-105	7314151830021	1	535,71	55
7444SG-M-110	7314151830038	1	590,67	55
7444SG-M-115	7314151830045	1	679,84	55
7444SG-M-120	7314151830052	1	989,69	55
7444SG-M-125	7314151830069	1	1.280,31	55
7444SG-M-130	7314151830076	1	1.392,43	55
7444SG-M-135	7314151830083	1	1.436,30	55
7444SG-M-140	7314151830090	1	1.628,91	55
7444SG-M-145	7314151830106	1	2.261,60	55
7444SG-M-150	7314151830113	1	2.380,87	55
7444SG-M-155	7314151830120	1	2.585,00	55
7444SG-M-160	7314150132508	1	2.739,29	55
7444SG-M-165	7314150132515	1	2.909,95	55
7444SG-M-170	7314150132522	1	3.198,45	55
7444SG-M-175	7314150132539	1	3.431,08	55
7444SG-M-24	7314150205400	1	36,28	55
7444SG-M-27	7314151829834	1	39,46	55
7444SG-M-30	7314151829841	1	40,66	55
7444SG-M-32	7314151829858	1	40,66	55
7444SG-M-34	7314151838560	1	59,56	55
7444SG-M-36	7314151829865	1	51,91	55
7444SG-M-38	7314150180936	1	61,09	55
7444SG-M-41	7314151829872	1	66,28	55
7444SG-M-42	7314151829889	1	66,28	55
7444SG-M-46	7314151829896	1	72,64	55
7444SG-M-50	7314151829919	1	81,67	55
7444SG-M-55	7314151829926	1	93,40	55
7444SG-M-60	7314151829933	1	98,45	55
7444SG-M-65	7314151829940	1	131,94	55
7444SG-M-70	7314151829957	1	152,58	55
7444SG-M-75	7314151829964	1	163,84	55
7444SG-M-80	7314151829971	1	217,98	55
7444SG-M-85	7314151829988	1	291,91	55
7444SG-M-90	7314151829995	1	381,65	55
7444SG-M-95	7314151830007	1	421,68	55
7444SG-Z-1.1/16	7314150132546	1	43,41	55
7444SG-Z-1.1/2	7314150132614	1	67,19	55
7444SG-Z-1.1/4	7314150132577	1	44,73	55
7444SG-Z-1.1/8	7314150132553	1	44,73	55
7444SG-Z-1.11/16	7314150132638	1	72,90	55
7444SG-Z-1.13/16	7314150132652	1	79,91	55
7444SG-Z-1.3/16	7314150132560	1	44,73	55
7444SG-Z-1.3/4	7314150132645	1	79,91	55
7444SG-Z-1.3/8	7314150132591	1	65,54	55
7444SG-Z-1.5/16	7314150132584	1	65,54	55
7444SG-Z-1.5/8	7314150132621	1	72,90	55
7444SG-Z-1.7/16	7314150132607	1	65,54	55
7444SG-Z-1.7/8	7314150132669	1	89,83	55
7444SG-Z-2	7314150132676	1	89,83	55
7444SG-Z-2.1/16	7314150132683	1	102,75	55
7444SG-Z-2.1/4	7314150132713	1	108,32	55
7444SG-Z-2.1/8	7314150132690	1	108,32	55
7444SG-Z-2.3/16	7314150132706	1	108,32	55

			€	
7444SG-Z-2.3/4	7314150132768	1	167,85	55
7444SG-Z-2.3/8	7314150132720	1	133,79	55
7444SG-Z-2.5/8	7314150132751	1	167,85	55
7444SG-Z-2.9/16	7314150132744	1	167,85	55
7444SG-Z-3	7314150132775	1	180,23	55
7444SG-Z-3.1/2	7314150132805	1	419,82	55
7444SG-Z-3.1/8	7314150132782	1	285,36	55
7444SG-Z-3.3/4	7314150132812	1	463,86	55
7444SG-Z-3.3/8	7314150132799	1	321,10	55
7444SG-Z-3.7/8	7314150132829	1	522,38	55
7444SG-Z-4	7314150132836	1	589,27	55
7444SG-Z-4.1/2	7314150132850	1	747,83	55
7444SG-Z-4.1/8	7314150132843	1	589,27	55
7454-1400	7314150119592	1	2.340,84	109
7454-1400E	7314150119615	1	3.814,89	109
7454-140A	7314150509515	1	465,56	108
7454-17	7314150509492	1	326,51	108
7454-230	7314150509522	1	473,80	108
7454-3.5	7314150509478	1	326,51	108
7454-32	7314150509508	1	244,30	108
7454-480	7314150119578	1	1.027,67	109
7454-70A	7314150509577	1	347,11	108
7454-8.4	7314150509485	1	326,51	108
7454-800A	7314150509584	1	834,30	108
7454-800E	7314150119608	1	1.712,80	109
7455-100	7314150125111	1	251,89	106
7455-1000	7314150368303	1	1.090,07	106
7455-100A	73141501340156	1	238,05	106
7455-15	7314150119646	1	251,88	106
7455-1500	7314150125166	1	1.390,00	107
7455-20	7314150125074	1	251,88	106
7455-200	7314150125128	1	277,07	106
7455-25	7314150125081	1	251,88	106
7455-2500	7314150125173	1	5.642,17	107
7455-300	7314150125104	1	311,00	106
7455-340	7314150125135	1	311,00	106
7455-5	7314150119639	1	251,88	106
7455-500	7314150125142	1	629,71	106
7455-60	7314150125098	1	251,89	106
7455-800	7314150125159	1	818,64	106
7456-80LB	7314150119783	1	314,87	107
7465-100	7314150340200	1	238,05	107
7465-15	7314150340170	1	225,53	107
7465-1500	7314150340248	1	1.741,58	107
7465-200	7314150340217	1	269,38	107
7465-30	7314150340187	1	231,80	107
7465-340	7314150340224	1	294,44	107
7465-5	7314150340163	1	220,51	107
7465-60	7314150340194	1	238,05	107
7465-800	7314150340231	1	751,76	107
747-1	7314150362899	1	48,70	51
747-1.1/16	7314150362905	1	48,70	51
747-1.1/2	7314150362974	1	60,14	51
747-1.1/4	7314150362936	1	48,70	51
747-1.1/8	7314150362912	1	46,92	51
747-1.11/16	7314150363001	1	85,15	51
747-1.13/16	7314150363025	1	97,64	51
747-1.15/16	7314150363049	1	97,13	51
747-1.3/16	7314150362929	1	48,70	51
747-1.3/4	7314150363018	1	89,91	51
747-1.3/8	7314150362950	1	48,70	51
747-1.5/16	7314150362943	1	49,90	51
747-1.5/8	7314150362998	1	80,97	51
747-1.7/16	7314150362967	1	60,14	51
747-1.7/8	7314150363032	1	97,64	51
747-1.9/16	7314150362981	1	61,94	51
747-1/2	7314150362813	1	32,28	51
747-10	7314150362516	1	32,81	51
747-11	7314150362523	1	34,30	51
747-11/16	7314150362844	1	38,47	51
747-12	7314150362530	1	31,79	51
747-13	7314150362547	1	31,79	51
747-13/16	7314150362868	1	41,91	51
747-14	7314150362554	1	29,53	51
747-15	7314150362561	1	37,87	51
747-15/16	7314150362882	1	48,70	51
747-16	7314150362578	1	38,57	51
747-17	7314150362585	1	35,61	51
747-18	7314150362592	1	41,91	51
747-19	7314150362608	1	35,61	51
747-2	7314150363056	1	100,62	51
747-2.1/16	7314150363063	1	102,18	51
747-2.1/2	7314150363131	1	149,81	51
747-2.1/4	7314150363094	1	133,36	51
747-2.1/8	7314150363070	1	129,79	51
747-2.3/16	7314150364893	1	133,36	51
747-2.3/4	7314150363162	1	156,11	51
747-2.3/8	7314150363117	1	140,17	51
747-2.5/16	7314150363100	1	133,36	51
747-2.5/8	7314150363155	1	156,11	51
747-2.7/8	7314150363124	1	149,81	51
747-2.7/16	7314150363179	1	195,77	51
747-2.9/16	7314150363148	1	149,81	51
747-20	7314150362615	1	48,12	51
747-21	7314150362622	1	48,12	51
747-22	7314150362639	1	48,12	51





747-23	7314150362646	1	48,70	51
747-24	7314150362653	1	49,18	51
747-25	7314150362660	1	49,48	51
747-26	7314150362677	1	49,90	51
747-27	7314150362684	1	48,70	51
747-28	7314150362691	1	52,75	51
747-3/4	7314150362851	1	38,47	51
747-3/8	7314150362790	1	31,57	51
747-30	7314150362707	1	48,70	51
747-32	7314150362714	1	48,70	51
747-34	7314150362721	1	53,12	51
747-36	7314150362738	1	60,14	51
747-40	7314150362745	1	74,43	51
747-41	7314150362752	1	86,93	51
747-42	7314150362769	1	86,93	51
747-46	7314150362776	1	103,00	51
747-5/8	7314150362837	1	38,47	51
747-50	7314150362783	1	103,00	51
747-7/16	7314150362806	1	32,97	51
747-7/8	7314150362875	1	48,70	51
747-9/16	7314150362820	1	32,29	51
749-1	7314150363506	1	54,78	54
749-1.1/16	7314150363513	1	54,78	54
749-1.1/2	7314150363582	1	100,50	54
749-1.1/4	7314150363544	1	63,21	54
749-1.1/8	7314150363520	1	54,78	54
749-1.11/16	7314150363612	1	106,71	54
749-1.13/16	7314150363636	1	123,63	54
749-1.15/16	7314150363650	1	132,68	54
749-1.3/16	7314150363537	1	59,87	54
749-1.3/4	7314150363629	1	120,52	54
749-1.3/8	7314150363568	1	84,70	54
749-1.5/16	7314150363551	1	81,86	54
749-1.5/8	7314150363605	1	106,71	54
749-1.7/16	7314150363575	1	86,37	54
749-1.7/8	7314150363643	1	123,63	54
749-1.9/16	7314150363599	1	102,49	54
749-1/2	7314150363421	1	50,91	54
749-10	7314150538386	10	15,66	54
749-11	7314150538362	10	15,66	54
749-11/16	7314150363452	1	53,95	54
749-13	7314150538348	10	4,53	54
749-13/16	7314150363476	1	53,95	54
749-14	7314150538324	10	17,00	54
749-15	7314150357543	1	57,76	54
749-15/16	7314150363490	1	54,78	54
749-16	7314150357550	1	51,20	54
749-17	7314150357567	1	64,45	54
749-18	7314150357574	1	51,20	54
749-19	7314150357581	1	64,45	54
749-2	7314150363667	1	137,20	54
749-2.1/4	7314150363698	1	143,40	54
749-2.1/8	7314150363674	1	143,40	54
749-2.3/16	7314150363681	1	143,40	54
749-2.3/4	7314150363728	1	167,69	54
749-2.3/8	7314150363704	1	150,20	54
749-2.5/8	7314150363711	1	167,69	54
749-20	7314150357598	1	53,58	54
749-21	7314150357604	1	65,78	54
749-22	7314150357611	1	65,78	54
749-23	7314150357628	1	58,95	54
749-24	7314150357635	1	59,72	54
749-25	7314150357642	1	60,14	54
749-26	7314150357659	1	74,51	54
749-27	7314150357666	1	73,51	54
749-3.1/8	7314150363735	1	239,94	54
749-3/4	7314150363469	1	53,95	54
749-3/8	7314150363407	1	50,00	54
749-5/8	7314150363445	1	53,95	54
749-7/16	7314150363414	1	50,00	54
749-7/8	7314150363483	1	53,46	54
749-9/16	7314150363438	1	53,73	54
7490	7314150052646	10	52,08	650
7490 CO	7314150052875	10	62,78	650
74P14-200	7314150416318	1	189,34	110
74P14-300	7314150416325	1	293,17	110
74P14-400	7314150416332	1	305,38	110
74P9-100	7314150416301	1	189,34	110
74P9-20	7314150416288	1	195,45	110
74P9-60	7314150416295	1	195,45	110
74PR-100	7314150416189	1	210,10	109
74PR-100A	7314150416196	1	210,10	109
74PR-20	7314150416158	1	195,45	109
74PR-200	7314150416202	1	213,77	109
74PR-300	7314150416219	1	256,52	109
74PR-400	7314150416226	1	299,27	109
74PR-60	7314150416165	1	205,21	109
74PR-60A	7314150416172	1	205,21	109
74PS-100	7314150416257	1	189,34	110
74PS-20	7314150416233	1	195,45	110
74PS-200	7314150416264	1	189,34	110
74PS-300	7314150416271	1	293,17	110
74PS-60	7314150416240	1	195,45	110
74S/H10	7314150218622	1	42,45	164
74S/H10-2P	7314150261635	1	16,98	164
74S/H12	7314150218639	1	56,56	164



74S/H12-2P	7314150261659	1	22,62	164
74S/H14	7314150218646	1	56,56	164
74S/H14-2P	7314150261666	1	22,62	164
74S/H17	7314150218653	1	56,56	164
74S/H17-2P	7314150261673	1	22,62	164
74S/H4	7314150218578	1	42,45	164
74S/H4-2P	7314150261543	1	16,98	164
74S/H5	7314150218585	1	42,45	164
74S/H5-2P	7314150261550	1	16,98	164
74S/H6	7314150218592	1	42,45	164
74S/H6-2P	7314150261567	1	16,98	164
74S/H7	7314150218608	1	42,45	164
74S/H7-2P	7314150261574	1	16,98	164
74S/H8	7314150218615	1	42,45	164
74S/H8-2P	7314150261611	1	16,98	164
74W14-200	7314150415700	1	293,17	106
74W14-300	7314150415717	1	329,81	106
74W14-400	7314150415724	1	390,89	106
74W9-100	7314150415687	1	230,87	106
74W9-15	7314150415656	1	244,31	106
74W9-200	7314150415694	1	293,17	106
74W9-25	7314150415663	1	243,09	106
74W9-50	7314150415670	1	230,87	106
74WR-100	7314150415540	1	244,06	106
74WR-100B	7314150469871	1	244,06	106
74WR-15	7314150415519	1	256,52	106
74WR-200	7314150415557	1	244,06	106
74WR-25	7314150415526	1	256,52	106
74WR-300	7314150415564	1	256,52	106
74WR-340	7314150415571	1	280,95	106
74WR-400	7314150415588	1	339,59	106
74WR-50	7314150415533	1	239,42	106
74WS-100	7314150415625	1	230,87	106
74WS-15	7314150415595	1	244,31	106
74WS-200	7314150415632	1	293,17	106
74WS-25	7314150415601	1	243,09	106
74WS-300	7314150415649	1	329,81	106
74WS-50	7314150415618	1	230,87	106
7590	7314150052660	10	52,25	650
7590 CO	7314150052882	10	68,41	650
7591	7314150197491	1	26,99	650
75EXT	7314150415311	1	238,20	111
75P1-1500	7314150415298	1	1.575,78	110
75P3-1000	7314150415281	1	1.453,62	110
75P3-650	7314150415267	1	1.087,17	110
75P3-800	7314150415274	1	1.191,00	110
75PS-650	7314150415328	1	1.062,74	110
75R1-1500	7314150415236	1	1.360,00	107
75R3-1000	7314150415229	1	1.453,62	107
75R3-650	7314150415205	1	1.087,17	107
75R3-800	7314150415212	1	1.215,43	107
75S-650	7314150415243	1	1.074,96	108
76R1-2000	7314150522378	1	2.050,00	108
76R3-1000	7314150422128	1	726,81	108
76R3-1500	7314150422135	1	1.535,32	108
76R3-600	7314150423118	1	671,85	108
76R3-800	7314150422111	1	696,28	108
76S-600	7314150423125	1	684,06	108
7710	7314151551445	1	76,83	89
7750	7314151096427	1	55,34	88
7750-SPARE	7314150187874	1	20,43	91
7750RN	7314151831240	1	52,45	88
7750RN-SPARE	7314150209361	1	17,62	91
7750SL	7314150197675	1	58,52	88
7750SL-SPARE	7314150210268	1	18,58	90
7751	7314150386949	10	43,97	90
7752	7314151096533	1	46,86	86
7754	7314151096557	1	18,09	87
7756	7314150489152	6	18,36	87
7758-10	7314150470891	1	29,03	87
7759	7314151096601	1	40,59	87
7760	7314151096618	1	12,84	87
7760W-3	7314150470907	10	11,19	87
7760W-6	7314150470914	10	12,44	87
7761	7314151096632	1	15,37	87
7762	7314151096649	1	19,01	87
7764	7314151096670	1	12,29	88
7765	7314151096687	1	10,24	81
7766	7314151096694	1	29,34	87
7767	7314153003577	1	24,17	82
7768	7314150128433	1	41,54	87
776EX-01	7314150386130	1	12,20	87
776EX-03	7314150386154	1	12,20	87
776EX-04	7314150386161	1	14,05	87
776EX-06	7314150386178	1	15,22	87
776EX-08	7314150386185	1	15,90	87
776EX-11	7314150386147	1	16,91	87
7772H	7314150476336	10	3,11	93
7773A	7314150512270	20	2,99	88
7800DM-10	7314151096991	10	6,40	92
7800DM-11	7314151097011	10	6,52	92
7800DM-12	7314151097035	10	6,90	92
7800DM-13	7314151097059	10	7,20	92
7800DM-14	7314151097073	10	7,58	92
7800DM-15	7314151097097	10	7,85	92
7800DM-16	7314151097110	10	8,00	92



7800DM-17	7314151097134	10	8,32	92
7800DM-18	7314151097158	10	8,32	92
7800DM-19	7314151097172	10	8,64	92
7800DM-20	7314151097196	10	8,88	92
7800DM-21	7314151097219	10	9,12	92
7800DM-22	7314151097233	10	9,45	92
7800DM-23	7314151097257	10	9,93	92
7800DM-24	7314151097271	10	10,65	92
7800DM-25	7314151097295	10	10,82	92
7800DM-26	7314151097318	10	11,04	92
7800DM-27	7314151097332	10	11,34	92
7800DM-28	7314151097356	10	12,17	92
7800DM-29	7314151097363	10	12,49	92
7800DM-30	7314151097370	10	12,64	92
7800DM-31	7314150464548	10	12,85	92
7800DM-32	7314151097387	10	13,14	92
7800DM-33	7314150169351	10	11,57	92
7800DM-34	7314150169405	10	16,49	92
7800DM-36	7314151097400	10	24,89	92
7800DM-8	7314151830854	10	6,40	92
7800DM-9	7314151830861	10	6,40	92
7800DMV-10	7314150121656	10	24,68	502
7800DMV-11	7314150121663	10	24,68	502
7800DMV-12	7314150121670	10	24,68	502
7800DMV-13	7314150121687	10	24,68	502
7800DMV-14	7314150121694	10	24,54	502
7800DMV-15	7314150121700	10	24,54	502
7800DMV-16	7314150121717	10	25,23	502
7800DMV-17	7314150121724	10	25,39	502
7800DMV-18	7314150121731	10	25,00	502
7800DMV-19	7314150121748	10	25,72	502
7800DMV-20	7314150121755	10	26,10	502
7800DMV-21	7314150121762	10	25,71	502
7800DMV-22	7314150121779	10	25,87	502
7800DMV-24	7314150121786	5	27,24	502
7800DMV-27	7314150121793	5	28,08	502
7800DMV-30	7314150121809	5	30,58	502
7800DMV-32	7314150121816	5	31,73	502
7800DMV-8	7314150121649	10	23,98	502
7800DZ-1	7314151097561	10	11,04	92
7800DZ-1.1/16	7314151097578	10	11,68	92
7800DZ-1.1/2	7314150464562	10	11,22	92
7800DZ-1.1/4	7314151097608	10	13,29	92
7800DZ-1.1/8	7314151097585	10	12,42	92
7800DZ-1.3/16	7314151097592	10	13,13	92
7800DZ-1.3/8	7314150464586	10	11,65	92
7800DZ-1.5/16	7314150166077	10	11,65	92
7800DZ-1.7/16	7314150464609	1	12,12	92
7800DZ-1/2	7314151097455	10	7,39	92
7800DZ-11/16	7314151097493	10	8,55	92
7800DZ-11/32	7314150465712	10	8,09	92
7800DZ-13/16	7314151097523	10	9,45	92
7800DZ-13/32	7314150464623	10	8,09	92
7800DZ-15/16	7314151097554	10	10,96	92
7800DZ-19/32	7314151097479	10	8,09	92
7800DZ-25/32	7314151097516	10	9,12	92
7800DZ-3/4	7314151097509	10	8,97	92
7800DZ-3/8	7314151097431	10	6,55	92
7800DZ-5/16	7314150464647	10	8,09	92
7800DZ-5/8	7314151097486	10	8,32	92
7800DZ-7/16	7314151097448	10	6,73	92
7800DZ-7/8	7314151097530	10	9,77	92
7800DZ-9/16	7314151097462	10	7,87	92
7800SM-10	7314151097851	10	6,52	91
7800SM-11	7314151097868	10	6,52	91
7800SM-12	7314151097875	10	6,90	91
7800SM-13	7314151097882	10	7,20	91
7800SM-14	7314151097899	10	7,58	91
7800SM-15	7314151097905	10	7,85	91
7800SM-16	7314151097912	10	8,00	91
7800SM-17	7314151097929	10	8,32	91
7800SM-18	7314151097936	10	8,32	91
7800SM-19	7314151097943	10	8,64	91
7800SM-20	7314150166206	10	9,07	91
7800SM-21	7314151097967	10	9,12	91
7800SM-22	7314151097974	10	9,45	91
7800SM-23	7314151097981	10	9,93	91
7800SM-24	7314151097998	10	10,65	91
7800SM-25	7314151098001	10	10,82	91
7800SM-26	7314151830823	10	11,04	91
7800SM-27	7314151098025	10	11,34	91
7800SM-28	7314151830830	10	12,17	91
7800SM-29	7314150166213	10	12,64	91
7800SM-30	7314151098056	10	12,64	91
7800SM-32	7314151098063	10	12,89	91
7800SM-33	7314150167319	10	11,57	91
7800SM-34	7314153011305	10	17,25	91
7800SM-36	7314151098087	10	24,44	91
7800SM-8	7314151830793	10	6,40	91
7800SM-9	7314151830809	10	6,52	91
7800SZ-1.3/16	7314150528387	10	7,79	92
7800SZ-1/2	7314150528400	10	7,39	92
7800SZ-11/16	7314150528424	10	5,41	92
7800SZ-13/16	7314150528448	10	5,71	92
7800SZ-3/4	7314150528462	10	5,61	92
7800SZ-3/8	7314150528486	10	4,41	92



7800SZ-7/16	7314150528509	10	4,58	92
7800SZ-7/8	7314150528523	10	6,05	92
7800SZ-9/16	7314150528547	10	4,64	92
7800TORX-E10	7314150166084	1	10,40	93
7800TORX-E11	7314150220359	1	10,40	93
7800TORX-E12	7314153011800	1	10,40	93
7800TORX-E14	7314153011756	1	10,40	93
7800TORX-E16	7314153011763	1	10,56	93
7800TORX-E18	7314153011770	1	10,56	93
7800TORX-E20	7314153011787	1	11,13	93
7800TORX-E24	7314153011794	1	12,23	93
7800TORX-E8	7314150166091	1	9,25	93
7800TORX/9	7314150469741	1	93,01	96
7805DM-10	7314151822101	10	17,14	92
7805DM-12	7314151098452	10	17,14	92
7805DM-13	7314151098469	10	17,14	92
7805DM-14	7314151098476	10	17,92	92
7805DM-15	7314151098483	10	18,83	92
7805DM-16	7314151098490	10	19,37	92
7805DM-17	7314151098506	10	19,37	92
7805DM-18	7314151098513	10	19,37	92
7805DM-19	7314151098520	10	19,37	92
7805DM-21	7314151098544	10	21,52	92
7805DM-22	7314151098551	10	21,73	92
7805DM-23	7314150313532	10	21,80	92
7805DM-24	7314151098568	10	22,38	92
7805DM-26	7314151098582	10	22,38	92
7805DM-27	7314151098599	10	24,80	92
7805DM-30	7314151098605	10	26,52	92
7805DM-32	7314150220281	10	27,18	92
7805DM-34	7314150488537	10	27,18	92
7805DZ-1	7314150357758	10	20,34	93
7805DZ-1.1/16	7314150357765	10	21,50	93
7805DZ-1.1/2	7314150357833	10	44,78	93
7805DZ-1.1/4	7314150357796	10	24,39	93
7805DZ-1.1/8	7314150357772	10	24,11	93
7805DZ-1.3/16	7314150357789	10	22,99	93
7805DZ-1.3/8	7314150357819	10	28,04	93
7805DZ-1.5/16	7314150357802	10	26,33	93
7805DZ-1.7/16	7314150357826	10	44,78	93
7805DZ-11/16	7314150357703	10	16,77	93
7805DZ-13/16	7314150357727	10	18,65	93
7805DZ-15/16	7314150357741	10	19,41	93
7805DZ-3/4	7314150357710	10	16,77	93
7805DZ-5/8	7314150357697	10	16,77	93
7805DZ-7/8	7314150357734	10	18,82	93
7805GPR-16	7314150503117	120	4,87	307
7805GPR-21	7314150503124	100	5,30	307
7805SM-10	7314153011312	10	17,47	91
7805SM-11	7314150475926	10	17,47	91
7805SM-12	7314153011329	10	17,47	91
7805SM-13	7314153011336	10	17,47	91
7805SM-14	7314153011343	10	18,20	91
7805SM-15	7314153011350	10	19,16	91
7805SM-16	7314153011367	10	19,66	91
7805SM-17	7314153011374	10	19,66	91
7805SM-18	7314153011381	10	19,66	91
7805SM-19	7314153011398	10	19,66	91
7805SM-20	7314153011404	10	20,11	91
7805SM-21	7314153011411	10	21,91	91
7805SM-22	7314153011428	10	22,08	91
7805SM-23	7314153011435	10	22,78	91
7805SM-24	7314153011442	10	22,78	91
7805SM-25	7314153011459	10	22,00	91
7805SM-26	7314153011466	10	22,78	91
7805SM-27	7314153011473	10	25,24	91
7805SM-28	7314153011480	10	23,54	91
7805SM-29	7314153011497	10	25,12	91
7805SM-30	7314153011503	10	26,99	91
7805SM-32	7314153011527	10	29,20	91
7805SM-34	7314153024251	10	29,20	91
7805SZ-1.1/2	7314150357987	1	44,78	91
7805SZ-1.1/4	7314150357949	1	24,39	91
7805SZ-1.3/16	7314150357932	1	22,99	91
7805SZ-1.3/8	7314150357963	1	28,04	91
7805SZ-1.5/16	7314150357956	1	26,33	91
7805SZ-1.7/16	7314150357970	1	44,78	91
7806MD	7314150220335	1	103,61	76
7807H	7314151232764	1	34,05	177
7807TE	7314150313792	1	72,98	76
7808H	7314151232771	1	34,05	177
7808HM	7314150220434	1	110,36	96
7809F-10	7314151830892	5	14,59	95
7809F-8	7314151830885	5	14,31	95
7809H	7314151232788	1	32,27	177
7809HL	7314150128464	1	12,74	96
7809M-10	7314151815608	1	14,08	96
7809M-10-120	7314150509669	1	11,60	96
7809M-12	7314151815615	1	14,39	96
7809M-12-120	7314150509683	1	11,60	96
7809M-14	7314151815622	1	14,42	96
7809M-14-120	7314150509706	10	11,60	96
7809M-17	7314151831028	1	15,13	96
7809M-17-120	7314150509720	10	11,60	96
7809M-19	7314151831035	1	15,55	96
7809M-19-120	7314150516575	8	11,60	96



7809M-4



7809M-4	7314150214600	10	12,98	96
7809M-4-120	7314150509591	1	11,60	96
7809M-5	7314151815561	1	12,98	96
7809M-5-120	7314150509607	1	11,60	96
7809M-5-180	7314151830922	1	21,46	96
7809M-6	7314151815578	1	12,98	96
7809M-6-120	7314150509621	1	11,60	96
7809M-7	7314151815585	1	12,98	96
7809M-7-100	7314151830960	1	17,07	96
7809M-8	7314151815592	1	14,08	96
7809M-8-120	7314151830984	1	19,64	96
7809M-9	7314151830991	1	14,08	96
7809M/10	7314151831448	1	147,00	73
7809PH-2	7314151830908	1	12,46	95
7809PH-3	7314151830915	1	12,85	95
7809PH-4	7314153003423	1	12,85	95
7809PZ-2	7314153003430	1	12,23	95
7809PZ-3	7314153003447	1	12,91	95
7809TO	7314150220465	1	151,67	96
7809TORX-T20	7314151811730	1	14,73	95
7809TORX-T20-120	7314150509768	1	20,09	96
7809TORX-T25	7314151811747	1	14,73	95
7809TORX-T25-120	7314150509799	1	20,09	96
7809TORX-T27	7314151811754	1	14,73	95
7809TORX-T27-120	7314150509812	1	20,09	96
7809TORX-T30	7314151811761	1	14,73	95
7809TORX-T30-120	7314150509836	1	20,09	96
7809TORX-T40	7314151811778	1	17,19	95
7809TORX-T40-120	7314150220564	1	21,97	96
7809TORX-T45	7314151811785	1	17,19	95
7809TORX-T45-120	7314150220557	1	21,97	96
7809TORX-T50	7314151811792	1	17,19	95
7809TORX-T50-100	7314150220540	1	21,97	96
7809TORX-T55	7314151811808	1	21,52	95
7809TORX-T55-120	7314150509874	1	25,44	96
7809TORX-T60	7314151811815	1	21,52	95
7809TORX-T60-120	7314150509898	1	25,44	96
7809TORX-T70	7314150509744	10	21,53	95
7809TORX-T70-140	7314150220526	5	31,08	96
7809TORX/10	7314151831455	1	160,82	73
7809XZN-10	7314151831080	1	19,10	97
7809XZN-10-100	7314151831097	1	23,61	97
7809XZN-12	7314151831103	1	23,61	97
7809XZN-12-100	7314151831110	1	25,79	97
7809XZN-14	7314153004574	1	25,23	97
7809XZN-14-100	7314153004567	1	29,51	97
7809XZN-16	7314150220458	1	27,65	97
7809XZN-18	7314150314058	1	29,46	97
7809XZN-6	7314150214617	1	18,08	97
7809XZN-8	7314151831066	1	18,20	97
7809XZN-8-100	7314151831073	1	19,91	97
7809Z-1/2	7314153003515	1	13,84	96
7809Z-1/4	7314153003478	1	12,75	96
7809Z-17/32	7314150313785	1	14,31	96
7809Z-19/32	7314153003546	1	14,56	96
7809Z-3/16	7314153003461	1	12,75	96
7809Z-3/8	7314153003492	1	12,75	96
7809Z-5/16	7314153003485	1	12,75	96
7809Z-5/8	7314153003553	1	14,56	96
7809Z-7/16	7314153003508	1	13,11	96
7809Z-9/16	7314153003539	1	14,20	96
7809Z/10	7314153003560	1	142,09	73
7810MB	7314150220380	1	75,77	76
7810MH	7314150220373	1	75,77	76
7811DMV	7314150122134	1	534,04	504
7812	7314150502028	100	13,53	318
7814DS	7314150318964	1	225,13	73
7817DZS	7314150319008	1	264,01	74
7817DZS1	7314150389902	1	212,56	75
7818DS	7314150318971	1	273,56	73
7818DST	7314150319039	1	243,83	75
7818MHR	7314150218912	1	274,78	73
7818SST	7314150319046	1	254,94	75
7819DRN	7314151831547	1	359,36	74
782-U	7311518276447	1	6,69	308
7823	7314150218141	1	75,46	170
7823DZS	7314150319015	1	310,93	75
7825DST	7314150319060	1	307,42	75
7825MBP	7314150218929	1	328,87	74
7825MHP	7314150218943	1	328,80	74
7825SST	7314150319053	1	307,42	75
7827DST	7314150319077	1	370,65	76
783	7311518276034	1	13,58	326
7835 G-160	7314150050253	5	44,50	245
7847SS	7314150318995	1	565,69	74
7851-G	7314150124909	1	172,89	115
7851-M	7314150124893	1	154,49	115
7865	7311518276720	1	43,82	170
787-1.1/16	7314150363186	1	48,70	51
787-1.1/2	7314150363254	1	61,20	51
787-1.1/4	7314150363216	1	54,63	51
787-1.1/8	7314150363193	1	48,70	51
787-1.11/16	7314150363278	1	136,67	51
787-1.13/16	7314150363292	1	136,67	51
787-1.3/16	7314150363209	1	54,63	51
787-1.3/4	7314150363285	1	136,67	51



787-1.3/8	7314150363230	1	59,40	51
787-1.5/16	7314150363223	1	54,63	51
787-1.5/8	7314150363261	1	67,13	51
787-1.7/16	7314150363247	1	60,59	51
787-1.7/8	7314150363308	1	148,54	51
787-2	7314150363315	1	148,54	51
787-2.1/4	7314150363346	1	178,16	51
787-2.1/8	7314150363322	1	166,31	51
787-2.3/16	7314150363339	1	166,31	51
787-2.3/8	7314150363353	1	190,11	51
7888DM	7314151820923	1	368,78	74
789-1.1/2	7314150363896	1	68,47	55
789-1.1/4	7314150363858	1	59,54	55
789-1.1/8	7314150363841	1	54,78	55
789-1.13/16	7314150363933	1	91,08	55
789-1.3/4	7314150363926	1	91,08	55
789-1.3/8	7314150363872	1	63,12	55
789-1.5/16	7314150363865	1	63,12	55
789-1.5/8	7314150363919	1	78,58	55
789-1.7/16	7314150363889	1	68,47	55
789-1.9/16	7314150363902	1	78,58	55
789-2	7314150363940	1	98,83	55
789-2.1/4	7314150363957	1	110,75	55
789-2.3/8	7314150363971	1	138,13	55
789-2.5/16	7314150363964	1	133,36	55
789-2.8	7314150363742	1	63,12	55
789-30	7314150363759	1	80,13	55
789-32	7314150357673	1	84,14	55
789-34	7314150363766	1	67,87	55
789-36	7314150363773	1	90,84	55
789-38	7314150363780	1	75,02	55
789-40	7314150363797	1	84,55	55
789-41	7314150363803	1	111,02	55
789-42	7314150363810	1	84,55	55
789-46	7314150363827	1	123,58	55
789-50	7314150363834	1	110,15	55
7890	7314150052691	10	55,62	651
7890 CO	7314150052899	10	68,41	651
7891	7314150052714	10	54,77	651
7891 CO	7314150052905	10	62,48	651
7892	7314150052738	10	65,32	651
7892 CO	7314150291687	10	57,10	651
7893	7314150052769	10	53,55	652
7893K	7314150351428	10	53,65	652
7894	7314150197484	10	26,06	652
790450A	7314150214716	1	65,98	264
790455A	7314150214709	1	56,03	264
7992	7314150470921	5	150,02	654
7993M0170	8413345115353	1	106,91	182
7993M0190	8413345115377	1	106,91	182
7993M0220	8413345115391	1	121,65	182
7993M0270	8413345115414	1	123,41	182
7993S0050	8413345115070	1	44,05	177
7993S0060	8413345115094	1	40,23	177
7993S0080	8413345115117	1	40,23	177
7993S0100	8413345115131	1	42,69	177
7993S0120	8413345115155	1	42,69	177
7993S0140	8413345115179	1	44,05	177
7993S0170	8413345115193	1	44,05	177
7993S0180	7314150476855	1	44,05	177
7993S0190	8413345115216	1	44,05	177
7993T0120	8413345115230	1	53,60	180
7993T0140	8413345115254	1	58,91	180
7993T0170	8413345115278	1	58,91	180
7993T0190	8413345115292	1	58,91	180
7993T0220	8413345115315	1	70,48	180
7993T0240	8413345115339	1	70,48	180
7994S0200	7314150492954	1	21,12	177
7994S0250	7314150492947	1	21,78	177
7994S0270	7314150492930	1	22,45	177
7994S0300	8413345129305	1	23,07	177
7994S0400	8413345129312	1	23,07	177
7994S0450	8413345129329	1	23,07	177
7994S0500	8413345129336	1	23,07	177
7994S0550	8413345129343	1	24,40	177
7994S0600	8413345129350	1	26,99	177
7994S0700	7314150522583	1	27,00	177
800-1.5-50ESD	8412243589327	10	3,89	653
800-2-50ESD	8412243589341	10	5,92	653
800-2.5-50ESD	8412243589365	10	3,38	653
800-3-50ESD	8412243589389	10	3,21	653
801-0-50ESD	8412243589426	10	4,11	653
801-00-50ESD	8412243589402	10	4,79	653
801-1-75ESD	8412243589440	10	4,50	653
801-7ESD	8412243589280	1	39,86	653
8010SL-2P	7314150243853	1	13,04	498
801C	7314150402151	10	173,65	652
8020-2P	7314150246601	1	8,78	195
803-10-50ESD	8412243589648	10	7,58	653
803-15-75ESD	8412243589549	10	7,67	653
803-20-75ESD	8412243589563	10	7,73	653
803-6-50ESD	8412243589464	10	5,62	653
803-7-50ESD	8412243589488	10	5,86	653
803-7ESD	8412243589303	1	41,10	653
803-8-50ESD	8412243589501	10	5,93	653
803-9-50ESD	8412243589525	10	7,58	653

			€	
8030-2P	7314150246618	1	8,78	195
8040-2P	7314150246625	1	8,78	195
8040L-2P	7314150246670	1	12,53	196
8040SL-2P	7314150243877	1	13,70	498
8045LVDE	7314151509163	10	20,96	219
8045VDE	73141515137256	10	17,12	219
805-TS1-50ESD	8412243589587	10	8,35	653
805-TS4-50ESD	8412243589600	10	6,33	653
805-TS5-50ESD	8412243589624	10	8,90	653
8050SL-2P	7314150243884	1	13,70	498
8052	7314151318406	5	28,73	218
806-1-1	7311518003760	6	4,56	219
806-1-2	7314150183258	6	5,96	219
806-1-3	7314150183265	6	6,04	219
8060B0080	8413345018104	1	13,05	267
8060B0100	8413345018111	1	18,12	267
8060B0120	8413345018128	1	20,01	267
8060B0140	8413345018135	1	20,15	267
8060B0180	8413345018142	1	28,42	267
8060B0240	8413345018159	1	48,42	267
8060B0360	8413345018166	1	71,05	267
8060T0080	8413345018173	1	9,80	267
8060T0100	8413345018180	1	9,21	267
8060T0140	8413345018203	1	9,50	267
8060T0180	8413345018210	1	9,94	267
8060T0240	8413345018227	1	15,81	267
8060T0360	8413345018234	1	24,50	267
8069	7314150007028	5	22,33	39
8069 C	7314150007035	5	16,40	39
8069 C IP	7314150101634	5	15,90	39
8069 IP	7314150007042	50	21,62	39
8069-1	7314150239511	1	4,88	39
8069-2	7314150238590	1	2,97	39
8070	7314150007110	5	23,45	39
8070 C	7314150007127	5	16,83	39
8070 C IP	7314150101641	5	16,31	39
8070 IP	7314150007134	40	22,81	39
8070-1	7314150239528	1	5,65	39
8070-2	7314150238606	1	3,10	39
8070V	7314150121519	2	39,14	501
8070VL	7314150213511	1	47,79	501
8071	7314150007202	5	25,44	39
8071 C	7314150007219	5	19,13	39
8071 C IP	7314150101658	5	18,65	39
8071 IP	7314150007226	50	24,80	39
8071-1	7314150239535	1	5,24	39
8071-2	7314150238613	1	3,13	39
8071V	7314150121526	2	47,59	501
8071VL	7314150213535	1	55,77	501
8071VLT	7314150121564	1	157,67	501
8072	7314150007288	5	33,16	39
8072 C	7314150007295	5	23,20	39
8072 C IP	7314150101665	5	22,71	39
8072 IP	7314150007301	30	32,51	39
8072-1	7314150239542	1	5,44	39
8072-2	7314150238620	1	3,43	39
8072V	7314150121533	2	53,05	501
8072VL	7314150213542	1	65,75	501
8072VLT	7314150121571	1	176,30	501
8073	7314150007363	5	48,19	39
8073 C	7314150007370	5	30,54	39
8073 C IP	7314150101672	5	30,04	39
8073 IP	7314150007387	20	47,55	39
8073-1	7314150239559	1	6,28	39
8073-2	7314150238637	1	3,77	39
8073V	7314150121540	2	70,38	501
8073VL	7314150213559	1	86,29	501
8073VLT	7314150121588	1	192,08	501
8074	7314150007448	3	78,75	39
8074 C	7314150007455	3	51,31	39
8074 C IP	7314150101689	3	50,80	39
8074 IP	7314150007462	20	78,12	39
8074-1	7314150239566	1	10,20	39
8074-2	7314150238644	1	4,43	39
8074V	7314150121557	2	113,80	501
8075	7314150007523	3	123,74	39
8075 C	7314150007530	3	79,61	39
8075 C IP	7314150101696	3	79,13	39
8075 IP	7314150007547	10	123,08	39
8075-1	7314150239573	1	13,53	39
8075-2	7314150238651	1	4,95	39
808050	7314153017642	50	41,83	211
808050A	7314150127306	1	26,73	217
808050L	7314150128075	25	40,34	211
808050L-SP1	7314150129218	1	10,25	211
808050P	7314150128105	50	40,34	211
808050P-25	7314150165179	10	127,62	211
808050S	7314150128082	25	21,43	212
808050S-18	7314150128921	30	37,78	212
808050S-22	7314150128938	30	37,78	212
808050TORX	7314150127313	50	26,11	217
808050TS	7314150128099	1	21,43	211
808060	7314150243822	1	39,96	498
808061	7314150243839	5	100,89	498
808062	7314150243846	5	100,89	498
8100B0140	7314150263028	1	30,74	267

			€	
8100B0180	7314150263042	1	40,80	267
8100B0240	8413345018296	1	54,23	267
8100B0360	8413345099660	1	100,78	267
8100F0180	7314150263059	1	17,84	267
8100F0240	7314150263066	1	20,75	267
8100T0100	7314150263073	1	6,56	267
8100T0140	8413345018333	1	7,84	267
8100T0180	7314150263080	1	10,53	267
8100T0240	7314150263097	1	14,67	267
8100T0360	7314150263103	1	25,98	267
8100T0480	7314150263127	1	17,13	267
8110H-1/2	7314153015860	1	99,97	97
8120-1/2	7314150384884	12	60,28	97
8120-1/4	7314150384921	20	38,34	84
8120-3/8	7314150384914	10	46,69	89
813	7314150055852	1	6,00	649
8130	7314150050918	10	49,23	644
8130-50/SUPR SPRING	7314150111572	1	3,52	649
8131	7314150050925	10	26,21	644
8131 CO	7314150051519	10	71,50	644
8132	7314150050932	10	65,11	644
8133	7314150470945	10	49,81	644
8134	7314150470952	10	49,81	644
8135	7314150470969	10	49,81	644
8136	7314150470976	10	49,81	645
8137	7314150459728	10	49,81	645
8138	7314150361540	10	49,81	645
814	7314150055845	1	4,52	649
8140	7314150050949	10	51,44	644
8140 CO	7314150051533	10	72,45	644
8140M2	7314150470983	10	45,40	649
8140PS	7314150358472	10	36,70	649
8141	7314150050987	10	50,35	644
8141 CO	7314150051557	10	52,69	644
8141PS	7314150349425	10	84,11	649
8142	7314150051007	10	57,57	644
8142 CO	7314150051564	10	77,68	644
8143	7314150051021	10	52,17	644
8144	7314150051045	10	49,23	644
8144 CO	7314150051601	10	75,58	644
8145	7314150051052	10	71,75	644
8146	7314150051076	10	47,27	645
8147	7314150051083	10	66,11	645
8148	7314150051090	10	71,10	645
8148 CO	7314150051656	10	86,32	645
8149	7314150051106	10	132,53	648
8150	7314150051113	10	64,12	644
8150 CO	7314150051670	10	74,53	644
8150 J	7314150051137	10	106,66	654
8150 SK	7314150112814	10	71,02	654
8150-1/2	7314151105006	1	64,90	97
8150-1/2-SPARE	7314150187881	1	30,58	98
8150-1/2V	7314150121601	1	195,16	502
8150M2	7314150470990	10	56,07	649
8150PS	7314150358489	10	43,39	649
8150RN-1/2	7314151831202	1	62,68	97
8150RN-1/2-SPARE	7314150209378	1	18,94	98
8150SL	7314150197682	1	66,06	97
8150SL-SPARE	7314150210275	1	20,55	98
8151	7314150051199	10	54,72	644
8151 CO	7314150051694	10	52,31	644
8151-1/2	7314151105112	1	85,37	98
8152	7314150052097	10	70,17	644
8152-1/2	7314151105129	1	47,45	93
8153	7314150051205	10	27,76	644
8154	7314150052103	10	68,58	644
8154 CO	7314150052233	10	73,96	644
8154-1/2V	7314150121595	1	62,24	502
8154-11	7314150469161	10	19,02	93
8154PSP	7314150347704	10	55,68	650
8155	7314150052110	10	83,57	644
8156	7314150051212	10	70,35	645
8157	7314150052127	10	72,61	645
8157-10	7314150467273	1	94,59	93
8157-15	7314150469222	1	55,01	93
8157-24	7314150469246	1	86,50	93
8157-36	7314150469260	10	132,68	93
8158	7314150052134	10	80,45	645
8158-10	7314150471003	1	30,39	93
8158-15	7314150471010	1	32,45	93
816	7314150428182	1	9,70	649
8160	7314150051229	10	61,61	644
8160 CO	7314150051724	10	77,30	644
8160 J	7314150051250	10	125,97	654
8160 M2	7314150381906	10	74,40	649
8160-1/2V	7314150121618	1	46,61	502
8160-10	7314150469185	10	18,57	93
8160-3	7314150469208	10	12,50	93
8160-5	7314150469284	10	14,74	93
8160-B	7314150182565	1	27,68	94
8160/SPRING	7314150229888	1	3,96	649
8160PS	7314150358496	10	53,93	649
8160W-10	7314150471027	10	21,29	94
8160W-3	7314150471041	10	16,16	94
8160W-5	7314150471065	10	16,96	94
8161	7314150051328	10	65,15	644





8161 CO	7314150051748	10	83,74	644
8161PS	7314150361533	10	52,90	649
8162	7314150051335	10	75,68	644
8162-1/2V	7314150121625	1	49,91	502
8163	7314150051342	10	53,34	644
8163 CO	7314150051762	10	70,77	644
8164	7314150052141	10	85,62	644
8164-1/2	7314151105266	1	12,29	88
8165	7314150052158	10	100,61	644
8165 CO	7314150052288	10	115,10	644
8166	7314150459377	10	32,96	94
8166L	7314150476350	10	149,97	645
8167	7314153003584	1	28,35	88
8167L	7314150476367	10	173,60	645
8168	7314150128440	1	38,32	94
8168L	7314150347711	10	173,60	645
8171	7314150469307	10	16,97	94
8172	7314150469321	10	20,18	94
8174A	7314150476374	10	9,74	94
8178	7314150512065	10	15,66	93
8194-1/2	7314151831226	1	6,23	98
8195-KEY	7314150389810	50	21,39	94
8195-R	7314150389780	1	52,93	97
8195-SET	7314150389797	5	64,47	97
8195-SQ	7314150389803	25	5,68	98
8211	7314150101030	10	80,57	646
8220SL-2P	7314150243860	1	13,04	498
8223	7314150112685	4	47,00	247
8223 IP	7314150113149	4	46,33	247
8224	7314150000012	4	55,34	247
8224 IP	7314150101757	4	54,67	247
8224CIP	7314150103607	4	34,93	247
8225	7314150000029	4	75,65	247
8225 IP	7314150101764	4	74,98	247
8225CIP	7314150103614	4	46,61	247
8226	7314150115853	1	84,27	247
8231	7311518266509	4	49,64	247
8231 IP	7311518270285	4	48,97	247
8242-2P	7314150243686	1	8,87	195
8242L-2P	7314150246687	1	12,53	196
8247	7314150051397	10	84,26	646
8247 CO	7314150051809	10	124,81	646
8248	7314150051427	10	97,85	647
8248 CO	7314150051823	10	133,10	647
8248Q	7314150349364	10	86,40	648
8249	7314150349401	10	33,12	647
8252-2P	7314150243693	1	8,87	195
8252L-2P	7314150246694	1	12,53	196
8252XL-1P	7314150265985	1	11,22	197
833AJ-4	7311518286927	1	36,92	590
833AJ-5	7311518286934	1	38,34	590
833AJ-6	7311518286941	1	39,91	590
833FJ-4	7311518286965	1	42,15	590
833FJ-5	7311518286972	1	43,41	590
833FJ-6	7311518286989	1	45,13	590
833PJ-4	7311518286897	1	33,25	589
833PJ-5	7311518286903	1	41,32	589
833PJ-67	7311518286910	1	41,32	589
833SB-4	7311518286859	1	61,80	590
833SB-5	7311518286866	1	94,31	590
833SB-6	7311518286873	1	108,96	590
833SB-7	7311518286880	1	141,46	590
834V-2	7314150124992	1	126,25	589
834V-4	7311518286811	1	291,57	589
834V-5	7311518286828	1	391,80	589
834V-6	7311518286835	1	495,07	589
834V-7	7311518286842	1	643,88	589
84-PODGER	7314150307494	1	37,11	40
850-1	7311518292737	10	17,59	548
8501-10	7311518004828	1	31,99	141
8501-10F	7311518220945	1	34,26	141
8501-12	7311518004842	1	33,48	141
8501-12F	7311518220952	1	39,39	141
8501-13	7311518004859	1	36,49	141
8501-136-10-24C	7314150371471	1	22,18	141
8501-136-20-24C	7314150371488	1	24,65	141
8501-13F	7311518220969	1	38,83	141
8501-15	7311518004873	1	38,47	141
8501-150-10-24C	7314150403004	1	27,11	141
8501-15F	7311518220976	1	42,09	141
8501-16	7311518004880	1	46,93	141
8501-160-20-24C	7314150403011	1	28,35	141
8501-160-20-48XF	7314150402892	1	28,35	141
8501-165-20-24C	7314150403028	1	28,35	141
8501-165-20-48XF	7314150402908	1	29,58	141
8501-16F	7311518220983	1	51,30	141
8501-16SW	7314150258642	1	49,45	141
8501-17	7311518004897	1	46,67	141
8501-17F	7311518220990	1	53,07	141
8501-17S	7311518221027	1	52,94	142
8501-184-16-24	7314150402946	1	32,03	141
8501-184-16-40	7314150402953	1	33,88	141
8501-184-20-24C	7314150403042	1	30,81	141
8501-18S	7311518221034	1	56,21	142
8501-18SW	7311518221058	1	52,72	141
8501-190-30-24C	7314150403059	1	36,97	141



8501-190-30-60XF	7314150402960	1	40,05	141
8501-2	7311518004743	1	25,52	141
8501-210-30-48SW	7314150403066	1	78,86	141
8501-210-30-60XF	7314150402977	1	46,83	141
8501-216-60SW	7314150359448	1	54,70	141
8501-22	7311518178888	1	47,48	141
8501-22F	7311518221003	1	54,70	141
8501-23	7311518004958	1	48,02	141
8501-230-30-60XF	7314150402984	1	51,75	141
8501-235-30-60XF	7314150402991	1	52,98	141
8501-23F	7311518018887	1	55,39	141
8501-260-24SW	7314150359479	1	72,48	141
8501-260-30-80S	7314150403097	1	80,10	142
8501-260-40SW	7314150359462	1	67,78	141
8501-260-60SW	7314150359455	1	71,48	141
8501-28	7311518018894	1	60,97	141
8501-28F	7311518221010	1	63,51	141
8501-28S	7311518221041	1	83,97	142
8501-28SW	7311518221065	1	70,20	141
8501-28XF	7311518281946	1	70,27	141
8501-3	7311518004750	1	24,84	141
8501-30	7311518237479	1	80,24	141
8501-305-30-40SW	7314150403073	1	41,78	141
8501-305-30-60SW	7314150403080	1	45,60	141
8501-305-30-96S	7314150403103	1	53,73	142
8501-30F	7311518237462	1	82,59	141
8501-30S	7311518282240	1	108,12	142
8501-30SW	7311518282196	1	91,42	141
8501-30XF	7311518281984	1	91,15	141
8501-31	7311518237455	1	82,27	141
8501-31F	7311518237448	1	90,79	141
8501-4	7311518008079	1	25,64	141
8501-40	7311518282042	1	108,31	141
8501-4F	7311518220914	1	26,89	141
8501-4XF	7311518281786	1	28,29	141
8501-5	7311518004774	1	29,75	141
8501-5F	7311518220921	1	31,99	141
8501-7	7311518004798	1	29,47	141
8501-7F	7311518220938	1	31,53	141
8510SL-2P	7314150245758	1	20,31	498
8520SL-2P	7314150245765	1	20,31	498
86	7314150005376	1	277,02	39
86-1	7314150254996	1	8,06	39
86-2	7314150255009	1	6,78	39
8600-2P	7314150246564	1	8,72	195
8610-2P	7314150243648	1	8,72	195
8610L-2P	7314150246700	1	12,34	196
8610SL-2P	7314150243891	1	13,70	498
8620-2P	7314150243662	1	8,78	195
8620L-2P	7314150246717	1	12,34	196
8620SL-2P	7314150243907	1	13,70	498
8620XL-1P	7314150265947	1	11,22	197
8630-2P	7314150246571	1	8,78	195
8630XL-1P	7314150265961	1	11,22	197
864000010	8413345137638	1	20,40	553
864000020	7314150330171	1	11,63	553
864002450	8413345129022	50	66,34	553
864100010	8413345137621	1	11,73	553
864102400	8413345129015	1	63,72	553
865-1	7311518292744	10	19,40	548
869102500	8413345083669	6	31,58	578
869103000	8413345116640	6	39,62	578
869203000	8413345137508	6	30,35	578
87	7314150005406	3	282,88	39
87-1	7314150255016	1	10,12	39
87-2	7314150255023	1	7,11	39
8703-2P	7314150246632	1	8,99	196
8704-2P	7314150246649	1	8,99	196
8705-2P	7314150246656	1	8,99	196
8706-2P	7314150246663	1	8,99	196
8710SL-2P	7314150245772	1	20,31	498
8720SL-2P	7314150245789	1	20,31	498
874002000	8413345024938	5	9,96	605
874002500	8413345024945	5	10,91	605
874003000	8413345024952	5	12,31	605
874003500	8413345024969	5	13,64	605
874004000	8413345024976	5	17,15	605
874005000	8413345024983	5	20,45	605
874102000	8413345080989	6	15,96	605
874102500	8413345081009	5	16,80	605
874103000	8413345081023	5	17,95	605
874103500	8413345081047	4	19,20	605
874104000	8413345081061	5	21,97	605
874602000	8413345024990	5	8,34	605
874602500	8413345025003	5	9,26	605
874603000	8413345025065	5	10,41	605
874603500	8413345025072	5	11,84	605
874604000	8413345025089	5	14,17	605
874916X16	7314150489787	1	5,31	606
874918X18	7314150489800	1	5,31	606
874923X13	7314150489763	1	5,31	606
874926X7	7314150489749	1	5,31	606
876002000	8413345025119	10	8,98	606
876002500	8413345025126	5	9,37	606
877002000	8413345025140	25	16,37	606
8800-2P	7314150246588	1	8,72	195

			€	
8810-2P	7314150243655	1	8,72	195
8810L-2P	7314150246724	1	12,34	196
8810SL-2P	7314150243914	1	13,70	498
8820-2P	7314150243679	1	8,78	195
8820L-2P	7314150246731	1	12,34	196
8820SL-2P	7314150243921	1	13,70	498
8820XL-1P	7314150265954	1	11,22	197
8821MB	7314150220571	1	828,15	77
8830-2P	7314150246595	1	8,78	195
8830XL-1P	7314150265978	1	11,22	197
8840M	7314151105495	1	1.204,85	77
8845DM	7314151105525	1	574,59	77
8845NM	7314151810955	1	583,74	77
8900DM-19	7314151105730	1	17,79	99
8900DM-21	7314150166367	5	15,36	99
8900DM-22	7314151105754	1	18,31	99
8900DM-23	7314150166374	1	17,34	99
8900DM-24	7314151105778	1	19,61	99
8900DM-25	7314151105785	1	19,05	99
8900DM-26	7314150219797	1	17,19	99
8900DM-27	7314151105822	1	19,99	99
8900DM-28	7314151105846	1	20,97	99
8900DM-29	7314150219803	1	19,72	99
8900DM-30	7314151105884	5	22,40	99
8900DM-32	7314151105891	1	23,36	99
8900DM-33	7314150166398	1	22,99	99
8900DM-34	7314151838478	1	24,85	99
8900DM-35	7314150219810	1	22,99	99
8900DM-36	7314151105914	1	27,02	99
8900DM-37	7314150166404	1	27,70	99
8900DM-38	7314150219827	1	31,72	99
8900DM-40	7314150166411	1	34,12	99
8900DM-41	7314151105938	5	31,68	99
8900DM-42	7314150166428	1	34,11	99
8900DM-46	7314151105952	1	37,38	99
8900DM-47	7314150166435	1	35,06	99
8900DM-50	7314151105969	5	42,59	99
8900DM-52	7314150166442	1	44,66	99
8900DM-54	7314150166459	3	44,66	99
8900DM-55	7314151105983	1	51,26	99
8900DM-56	7314150166466	1	52,29	99
8900DM-60	7314151106003	5	56,98	99
8900DZ-1	7314151106058	1	19,74	99
8900DZ-1.1/16	7314151106065	1	20,39	99
8900DZ-1.1/2	7314151106133	1	28,97	99
8900DZ-1.1/4	7314151106096	1	23,63	99
8900DZ-1.1/8	7314151106072	1	21,38	99
8900DZ-1.11/16	7314150166282	1	33,86	99
8900DZ-1.13/16	7314151106188	1	37,86	99
8900DZ-1.3/4	7314151106171	1	37,86	99
8900DZ-1.3/8	7314151106119	1	25,63	99
8900DZ-1.5/16	7314151106102	5	25,63	99
8900DZ-1.5/8	7314151106157	1	32,63	99
8900DZ-1.7/8	7314151106195	1	43,12	99
8900DZ-1.9/16	7314150166299	1	33,47	99
8900DZ-13/16	7314150166305	1	16,33	99
8900DZ-15/16	7314151106034	1	19,58	99
8900DZ-2	7314151106201	1	43,12	99
8900DZ-2.1/16	7314150166312	1	43,01	99
8900DZ-2.1/4	7314150166329	1	44,90	99
8900DZ-2.1/8	7314150166336	1	43,02	99
8900DZ-2.3/16	7314150358670	1	48,95	99
8900DZ-2.3/8	7314150166350	1	54,09	99
8900DZ-3/4	7314150166381	1	12,52	99
8900DZ-31/32	7314150358663	1	22,56	99
8900DZ-7/8	7314150166473	1	19,83	99
8900SM-19	7314150166633	1	18,03	98
8900SM-22	7314151810795	1	18,03	98
8900SM-23	7314150219834	1	18,03	98
8900SM-24	7314151810801	5	19,35	98
8900SM-26	7314150219841	5	19,61	98
8900SM-27	7314151810818	5	19,99	98
8900SM-28	7314150166657	1	19,99	98
8900SM-29	7314150219858	1	22,40	98
8900SM-30	7314151810825	5	22,40	98
8900SM-32	7314151810832	5	23,36	98
8900SM-33	7314150166671	1	23,36	98
8900SM-34	7314151838461	1	24,85	98
8900SM-35	7314150166688	1	24,85	98
8900SM-36	7314151810849	5	27,02	98
8900SM-38	7314151810856	1	28,75	98
8900SM-41	7314151810863	5	31,68	98
8900SM-42	7314150219865	1	31,68	98
8900SM-46	7314151810870	1	37,38	98
8900SM-50	7314151810887	1	42,60	98
8900SM-55	7314151810894	1	51,25	98
8900SM-60	7314151810900	1	56,98	98
8900SZ-1	7314150166480	1	24,01	98
8900SZ-1.7/16	7314150166589	1	30,15	98
8900SZ-1.7/8	7314150166596	1	41,76	98
8900SZ-1.9/16	7314150166602	1	31,41	98
8900SZ-13/16	7314150166619	1	21,90	98
8900SZ-2	7314150166640	1	45,50	98
8900SZ-3/4	7314150166664	1	15,87	98
89049TM-1000	7314150415403	1	1.575,78	113
8905-TM	7314150125470	1	1.493,67	114

			€	
8910-2P	7314150243709	1	8,72	196
8910SL-2P	7314150243938	1	15,23	498
8915-2P	7314150243716	1	8,72	196
8915L-2P	7314150258765	1	13,35	196
8915SL-2P	7314150243945	1	15,23	498
8920-2P	7314150243723	1	8,78	196
8920L-2P	7314150258772	1	13,35	196
8920SL-2P	7314150243952	1	15,23	498
89222CR-1000	7314150415441	1	3.053,84	114
8925-2P	7314150243730	1	8,78	196
8925L-2P	7314150258789	1	13,35	196
8925SL-2P	7314150243968	1	15,23	498
8927-2P	7314150243747	1	8,78	196
8927L-2P	7314150263516	1	13,35	196
8930-2P	7314150243754	1	8,87	196
8930L-2P	7314150258796	1	13,35	196
8930SL-2P	7314150243976	1	15,23	498
8940-2P	7314150243761	1	8,87	196
894M-10	7314151833039	10	3,43	51
894M-100	7314151833305	1	319,36	51
894M-105	7314151833312	1	417,14	51
894M-11	7314151833046	10	3,52	51
894M-110	7314151833329	1	466,12	51
894M-115	7314151833336	1	528,69	51
894M-12	7314151833053	10	3,52	51
894M-120	7314151833343	1	556,07	51
894M-125	7314150132478	1	641,65	51
894M-13	7314151833060	10	3,52	51
894M-130	7314150132485	1	664,74	51
894M-135	7314150132492	1	745,28	51
894M-14	7314151833077	10	4,12	51
894M-15	7314151833084	10	4,27	51
894M-16	7314150139569	10	4,56	51
894M-17	7314151833091	10	3,52	51
894M-19	7314151833107	10	4,78	51
894M-21	7314150223220	5	5,14	51
894M-22	7314151833114	5	5,95	51
894M-24	7314151833121	5	7,17	51
894M-27	7314151833138	5	8,19	51
894M-30	7314151833145	5	9,65	51
894M-32	7314151833152	5	10,88	51
894M-34	7314150139583	1	18,09	51
894M-36	7314151833169	5	14,15	51
894M-38	7314151833176	1	22,06	51
894M-41	7314151833183	1	22,45	51
894M-46	7314151833190	1	25,40	51
894M-50	7314151833206	1	31,81	51
894M-55	7314151833213	1	37,58	51
894M-60	7314151833220	1	52,96	51
894M-65	7314151833237	1	63,53	51
894M-70	7314151833008	10	3,43	51
894M-75	7314151833244	1	74,20	51
894M-8	7314151833251	1	127,79	51
894M-80	7314151833015	10	3,43	51
894M-85	7314151833268	1	150,86	51
894M-9	7314151833275	1	184,14	51
894M-90	7314151833022	10	3,52	51
894M-95	7314151833282	1	205,94	51
8950NA-SO/2	7314151833299	1	313,27	51
8950RN/A	7314150521258	1	99,70	100
8951	7314151106782	1	113,30	100
8951-M	7314150124916	1	346,92	101
8952N/B	7314150180219	1	237,90	115
8953E-32	7314150509447	1	23,43	99
8954-15	7314150522774	1	77,97	99
8954A	7314151106812	1	69,22	99
8955N	7314150434114	1	36,66	99
8955N-SPARE	7314150434121	1	117,09	100
8955N/A	7314150434053	1	49,29	101
8955N/B	7314150434176	5	92,44	100
8957-19	7314150522781	1	32,96	100
8957A	7314150510580	1	94,25	99
8958A	7314151106836	1	76,50	99
895M-10-11	7314151832742	10	92,95	99
895M-10-13	7314151832759	10	3,43	49
895M-13-17	7314151832803	10	3,43	49
895M-17-19	7314151832827	10	4,12	49
895M-19-22	7314151832834	10	5,08	49
895M-19-24	7314151832841	5	6,22	49
895M-22-24	7314151832858	5	7,12	49
895M-24-27	7314151832865	5	7,46	49
895M-24-30	7314151832872	5	9,89	49
895M-27-32	7314151832889	5	11,74	49
895M-30-32	7314151832896	5	14,20	49
895M-30-36	7314151832902	5	17,45	49
895M-32-36	7314151832919	1	20,02	49
895M-36-41	7314151832926	1	20,02	49
895M-41-46	7314151832933	1	27,73	49
895M-46-50	7314151832940	1	33,74	49
895M-50-55	7314151832957	1	40,54	49
895M-55-60	7314151832964	1	53,45	49
895M-6-7	7314151832711	1	67,42	49
895M-65-70	7314151832971	10	3,47	49
895M-8-10	7314151832735	10	132,69	49
			3,14	49





895M-8-9	7314151832728	10	3,14	49
8960-16	7314150492855	12	48,62	100
8960-8	7314150492862	1	39,03	100
8963	7314150181087	1	39,56	99
8966	7314151106898	1	94,65	100
8967	7314153003591	1	32,65	94
8967/S3	7314153003607	1	85,14	82
8971	7314150492879	1	26,68	100
8972	7314150492886	1	29,82	100
9-12-51/3806-KP	7311518044558	5	18,52	634
9-462-14-0-0	7311518020873	5	56,83	35
9-467-00-0-0	7311518020897	1	43,24	35
9-469-00-0-0	7311518020903	1	16,46	35
9-484-3.2-10	7311518193348	10	1,78	35
9-484-3.2-1P	7311518193522	10	3,07	35
9-484-5.2-10	7311518193355	10	1,78	35
9-484-5.2-1P	7311518193331	10	3,07	35
9-485-04-10	7314150271672	10	3,07	36
9-485-04-1P	7314150271665	10	3,07	36
9-485-05-10	7314150271696	10	3,07	36
9-485-05-1P	7314150271689	10	3,07	36
9-485-06-10	7311518193508	10	3,34	36
9-485-06-1P	7311518193492	20	4,50	36
9-485-09-10	7311518193386	10	3,34	36
9-485-09-1P	7311518193362	20	4,50	36
9-485-13-10	7311518193393	10	3,34	36
9-485-13-1P	7311518193379	1	4,50	36
9-486-04-10	7311518193430	10	3,34	36
9-486-04-1P	7311518193409	20	4,50	36
9-486-05-10	7311518193461	10	3,34	36
9-486-05-1P	7311518193447	20	4,50	36
9-486-07-10	7311518249373	10	3,35	36
9-486-07-1P	7311518249359	20	4,50	36
9-486-08-10	7311518270933	10	4,49	36
9-486-C-10	7311518209599	10	3,19	36
9-486-C-1P	7311518209605	10	4,26	36
9-488-02-10	7311518194772	10	2,54	35
900T-020-100	7314153018106	5	10,41	216
900T-025-100	7314153018113	5	10,41	216
900T-030-100	7314153018120	5	10,41	216
900T-040-150	7314153018137	5	11,63	216
900T-050-150	7314153018144	5	12,09	216
900T-060-200	7314153018151	5	12,85	216
900T-080-200	7314153018168	5	14,09	216
900T-100-200	7314153018175	5	15,61	216
901T-006-100	7314153018182	5	7,54	216
901T-007-100	7314153018199	5	7,54	216
901T-008-100	7314153018205	5	7,54	216
901T-009-100	7314153018212	5	7,54	216
901T-010-100	7314153018229	5	10,69	216
901T-015-150	7314153018236	5	10,88	216
901T-020-150	7314153018243	5	10,88	216
901T-025-150	7314153018250	5	11,93	216
901T-027-150	7314153018267	5	11,93	216
901T-030-200	7314153018274	5	12,85	216
901T-040-200	7314153018281	5	13,45	216
901T-045-200	7314153018298	5	13,45	216
901T-050-200	7314153018304	5	13,45	216
9029	7314153010612	5	30,52	38
9029 C	7314153010629	5	35,78	38
9029-1	7314150239580	1	5,99	39
9029-2	7314150238668	1	3,43	39
9029-T	7314150189076	5	35,20	38
9029T-1	7314150312139	1	13,35	39
902T-050-150	7314153018311	5	12,49	216
902T-055-150	7314153018328	5	12,49	216
902T-060-150	7314153018335	5	13,32	216
902T-070-175	7314153018342	5	14,09	216
902T-080-175	7314153018359	5	14,36	216
902T-090-175	7314153018366	5	14,36	216
902T-100-175	7314153018373	5	15,30	216
902T-110-175	7314153018380	5	15,30	216
902T-120-175	7314153018397	5	17,14	216
902T-130-175	7314153018403	5	18,06	216
9031	7314150110988	5	33,17	38
9031 C	7314150113507	5	38,37	38
9031 P-1	7314150266302	1	8,40	39
9031-1	7314150239597	1	5,80	39
9031-8224	7314150321193	3	86,43	258
9031-T	7314150131648	5	40,96	38
9031P	7314150187539	5	35,94	38
9031T-1	7314150312146	1	13,46	39
9033	7314150181414	5	43,27	38
9033-1	7314150353804	1	12,66	39
9035	7314150181421	5	62,72	38
9035-1	7314150353811	1	14,15	39
903T-1	7314153018410	1	76,66	215
903T-2	7314153018427	1	70,74	215
903T-3	7314153018434	1	87,63	216
9045-B-200	7311518012175	6	25,55	544
9045-B-250	7311518012182	6	27,04	544
9045-B-300	7311518012199	6	29,49	544
9045-B-400	7311518178123	1	34,39	544
9048-200	7314150138159	10	20,53	544
9048-250	7314150138166	10	21,24	544
9048-300	7314150138173	10	24,26	544



9048-350	7314150180349	10	24,29	544
9048-400	7314150138180	10	25,71	544
904T-060-150	7314153019837	5	19,21	217
905T-060-100	7314153019844	5	16,08	216
9070	7314150100170	5	29,11	38
9070 P	7314150103416	5	32,59	38
9070 P-1	7314150239610	1	8,16	39
9070 PC	7314150103423	5	29,05	38
9070C	7314150100187	5	26,36	38
9071	7314150100194	5	31,61	38
9071 P	7314150103430	5	34,79	38
9071 P-1	7314150239627	1	7,97	39
9071 PC	7314150103447	5	31,11	38
9071C	7314150100200	5	28,23	38
9072	7314150055609	5	41,16	38
9072 C	7314150055616	5	36,36	38
9072 P	7314150056354	5	44,61	38
9072 P-1	7314150239634	1	8,77	39
9072 PC	7314150056361	5	39,06	38
9073	7314150101702	5	59,86	38
9073 C	7314150101719	3	53,08	38
9073 P	7314150101726	5	63,33	38
9073 P-1	7314150239641	1	9,95	39
9073 PC	7314150101733	3	55,77	38
91-023-5P	7311518032593	1	4,41	138
91-027-5P	7311518032616	1	5,79	138
91-143-100P	7311518224363	1	111,52	138
91-143-25P	7311518266578	1	27,85	138
91-143-5P	7311518032630	1	6,10	138
91-148-5P	7311518032654	1	7,15	138
91-223-5P	7311518032661	1	6,42	138
91-226-5P	7311518032685	1	8,99	138
91-233-5P	7311518260057	1	8,68	138
91-243-5P	7311518032692	1	7,21	138
91-2PW-5P	7311518260163	1	10,51	138
91-3PM-5P	7311518260156	1	8,50	138
91-412-5P	7311518260040	1	13,52	138
91-433-5P	7311518260101	1	13,03	138
91-434-5P	7311518260026	1	17,87	138
91-443-5P	7311518032722	1	18,67	138
91-444-5P	7311518260033	1	19,10	138
91-4PMM-5P	7311518260170	1	13,30	138
91-502-5P	7311518032746	1	7,21	138
91-512-25P	7311518266592	1	35,13	138
91-512-5P	7311518032753	1	8,84	138
91-517-5P	7311518032777	1	7,95	138
91-522-5P	7311518032784	1	7,46	138
91-611-5P	7311518260071	1	9,61	138
91-612-5P	7311518032814	1	7,77	138
91-622-5P	7311518260088	1	9,02	138
91-623-5P	7311518260064	1	13,52	138
91-7V1-5P	7311518260118	1	16,53	138
91-METAL-10P	7314150449477	1	18,82	138
91-MIXED-10P	7314150449491	1	18,02	138
91-WOOD-10P	7314150449446	1	16,42	138
91C	7314150182381	5	27,40	40
92-001-1P	7314150474998	90	32,38	140
92-106-1P	7314150474899	90	26,15	139
92-113-1P	7314150474912	90	23,61	140
92-118-1P	7314150474950	90	46,52	140
92-133-1P	7314150474134	70	18,26	139
92-133-3P	7314150474158	46	47,92	139
92-136-1P	7314150474783	20	29,67	141
92-136-G120-5P	7314150498079	10	3,99	141
92-136-G240-5P	7314150498116	10	3,99	141
92-136-G40-5P	7314150497997	10	3,99	141
92-136-G80-5P	7314150498031	10	3,99	141
92-137-1P	7314150475070	50	12,29	141
92-137-G120-5P	7314150498093	10	3,99	141
92-137-G240-5P	7314150498130	10	3,99	141
92-137-G40-5P	7314150498017	10	3,99	141
92-137-G80-5P	7314150498055	10	3,99	141
92-157-1P	7314150474820	70	14,84	139
92-160-1P	7314150474172	70	17,12	139
92-160-3P	7314150474196	46	52,49	139
92-165-1P	7314150475018	90	10,56	140
92-166-1P	7314150474974	50	78,90	140
92-174-1P	7314150474936	90	46,52	140
92-205-1P	7314150474219	70	20,54	139
92-205-3P	7314150474356	46	58,53	139
92-221-1P	7314150474721	70	18,26	139
92-222-1P	7314150474592	70	18,83	139
92-222-3P	7314150474370	46	53,66	139
92-223-1P	7314150474684	70	19,40	139
92-223-3P	7314150474400	46	51,91	139
92-225-1P	7314150474707	70	15,40	139
92-226-1P	7314150475032	90	19,69	140
92-228-1P	7314150474745	70	17,12	139
92-229-1P	7314150474769	70	17,12	139
92-236-1P	7314150474806	70	29,67	139
92-245-1P	7314150475056	90	30,64	140
92-251-1P	7314150474868	70	25,36	140
92-WM-SET-8P	7314150486830	34	119,92	140
9210	7311518278182	1	249,92	640
9210-1	7311518278212	1	54,23	640
9210-10	7311518278229	1	101,79	640

			€	
9210-1060177	7311518295424	1	0,90	641
9210-1060238	7311518295394	20	0,47	641
9210-1230219	7311518295387	20	6,78	641
9210-1230235	7311518295325	1	7,85	640
9210-1320281	7311518295431	10	9,03	641
9210-1640142	7311518295356	1	8,45	640
9210-1690148	7311518295332	1	19,28	640
9210-1700118	7311518295363	1	40,84	641
9210-1710266	7311518295417	1	66,75	641
9210-1720100	7311518295295	1	11,14	640
9210-1730107	7311518295349	10	13,41	640
9210-1770106	7311518295370	10	5,62	641
9210-1830137	7311518295400	1	8,95	641
9210-20	7311518278236	1	13,99	640
92C	7314150182398	5	31,24	40
93C	7314150182404	5	37,07	40
94C	7314150182411	5	47,37	40
9500DZ-1.13/16	7314150227501	1	40,11	101
9500DZ-1.5/8	7314150227495	1	34,42	101
9500DZ-1.7/8	7314150227518	1	40,11	101
9500DZ-2	7314150227525	1	52,67	101
9500DZ-2.1/2	7314150227570	1	60,61	101
9500DZ-2.1/4	7314150227556	1	52,67	101
9500DZ-2.1/8	7314150227532	1	52,67	101
9500DZ-2.15/16	7314150227617	1	82,35	101
9500DZ-2.3/16	7314150227549	1	52,67	101
9500DZ-2.3/4	7314150227600	1	68,91	101
9500DZ-2.3/8	7314150227563	1	60,61	101
9500DZ-2.5/8	7314150227594	1	70,22	101
9500DZ-2.9/16	7314150227587	1	60,61	101
9500DZ-3	7314150227624	1	94,61	101
9500DZ-3.1/8	7314150227631	1	94,61	101
9500SM-41	7314153013699	1	46,68	101
9500SM-46	7314153013705	1	54,44	101
9500SM-50	7314153013712	1	60,22	101
9500SM-54	7314153013729	1	64,18	101
9500SM-55	7314153013736	1	68,55	101
9500SM-58	7314153013743	1	74,92	101
9500SM-60	7314153013750	1	83,73	101
9500SM-63	7314153013767	1	93,85	101
9500SM-65	7314153013774	1	100,08	101
9500SM-67	7314153013781	1	106,59	101
9500SM-70	7314153013798	1	112,44	101
9500SM-71	7314153013804	1	118,34	101
9500SM-75	7314153013811	1	125,85	101
9500SM-77	7314153013828	1	133,85	101
9500SM-80	7314153013835	1	143,32	101
9500SM-82	7314153013842	1	152,81	101
9505-3400	7314150125517	1	3.890,67	114
9505-TM	7314150125487	1	1.493,67	114
95155B-3000	7314150415410	1	4.336,45	114
9525-10	7311518031817	1	18,60	156
9525-3400	7314150125524	1	7.208,79	114
9525-7	7311518031800	1	14,62	156
9525CR-4000	7314150415465	1	4.873,93	114
9526B-4500	7314150415427	1	4.519,69	114
9527CR-2000	7314150415458	1	3.359,23	114
9528-MD-15-45	7311518007447	10	40,34	155
9540DZ	7314150414048	1	1.358,07	78
9540DZL	7314150414055	1	1.858,94	78
9540MB	7314153014108	1	1.154,73	77
9540MBL	7314153014115	1	1.707,50	77
9550N	7314150424160	1	263,03	102
9550N-SPARE	7314150424153	1	73,95	102
9550N/A	7314150424146	1	215,72	102
9550N/B	7314150424788	1	53,93	102
9555	7314153014047	1	100,07	101
9555AB	7314153014061	1	46,75	101
956	7314150025190	1	5,42	572
9560AB	7314153014078	1	75,71	101
9563AB	7314153014085	1	96,99	101
9565AB	7314153014092	1	50,59	102
9566A	7314150220618	1	88,59	101
9572	7314150178599	5	48,19	40
9572-200	7311518004231	20	25,52	544
9572-250	7311518004248	20	27,07	544
9574-200	7314150138197	10	20,86	544
9574-250	7314150138203	10	21,40	544
9574-300	7314150180356	10	22,65	544
9575-250	7314150185894	6	31,63	544
95C	7314150182428	1	79,28	40
960100010	8413345031073	1	37,08	461
960100020	8413345031080	1	40,16	461
960100030	8413345031097	1	43,65	461
960100050	8413345031103	1	51,36	461
960100060	8413345031110	1	55,58	461
9625-6.35QC	7314150441716	1	27,11	156
9625-9500	7314150125555	1	6.437,50	114
96255CR-7000	7314150415489	1	6.101,57	114
9626-10	7314150388844	1	16,43	154
9626-11	7314150388851	1	16,71	154
9626-12	7314150388868	1	17,08	154
9626-13	7314150388875	1	17,52	154
9626-14	7314150388882	1	18,05	154
9626-15	7314150444526	1	18,85	154
9626-16	7314150388899	1	20,67	154

			€	
9626-18	7314150388905	1	26,38	154
9626-20	7314150388912	1	29,90	154
9626-22	7314150388929	1	33,42	154
9626-23	7314150388936	1	35,04	154
9626-24	7314150388943	1	36,63	154
9626-25	7314150388950	1	38,31	154
9626-26	7314153024237	1	39,98	154
9626-28	7314150388967	1	47,19	154
9626-30	7314150388974	1	67,56	154
9626-32	7314150388981	1	67,56	154
9626-35	7314150444533	1	67,56	154
9626-6	7314150388806	1	14,70	154
9626-7	7314150388813	1	15,11	154
9626-8	7314150388820	1	15,48	154
9626-9	7314150388837	1	16,07	154
9627-10-460	7314150389018	1	25,91	154
9627-12-460	7314150389025	1	26,24	154
9627-14-460	7314150389032	1	28,26	154
9627-16-460	7314150389049	1	29,60	154
9627-18-460	7314150389056	1	34,32	154
9627-20-460	7314150389063	1	38,69	154
9627-22-460	7314150389070	1	40,37	154
9627-24-460	7314150389087	1	43,75	154
9627-26-460	7314150389094	1	47,10	154
9627-28-460	7314150389100	1	48,78	154
9627-30-460	7314150389117	1	59,70	154
9627-32-460	7314150389124	1	67,28	154
9627-6-460	7314150388998	1	25,23	154
9627-8-460	7314150389001	1	25,58	154
9629-10	7314150388479	1	6,01	155
9629-12	7314150388486	1	6,01	155
9629-13	7314150440238	1	5,70	155
9629-14	7314150388493	1	6,38	155
9629-16	7314150388509	1	6,38	155
9629-17	7314150440245	1	6,38	155
9629-18	7314150388516	1	6,38	155
9629-19	7314150440252	1	6,38	155
9629-20	7314150388523	1	6,95	155
9629-22	7314150388530	1	6,95	155
9629-24	7314150388547	1	6,95	155
9629-25	7314150388554	1	6,95	155
9629-26	7314150388561	1	6,59	155
9629-28	7314150388578	1	10,85	155
9629-30	7314150388585	1	10,89	155
9629-32	7314150388592	1	10,94	155
9629-35	7314150440269	1	10,75	155
9629-36	7314150388608	1	11,64	155
9629-38	7314150388615	1	12,78	155
9629-40	7314150388622	1	12,78	155
9629-6	7314150388417	1	7,07	155
9629-8	7314150388462	1	5,28	155
9629-SET-8	7314150441648	12	30,81	155
9631-10-400	7314150388684	1	10,17	155
9631-12-400	7314150388691	1	11,28	155
9631-13-400	7314150447572	1	8,80	155
9631-14-400	7314150388707	1	9,64	155
9631-16-400	7314150388714	1	10,62	155
9631-18-400	7314150388721	1	11,97	155
9631-19-400	7314150447589	1	10,84	155
9631-20-400	7314150388738	1	11,97	155
9631-22-400	7314150388745	1	13,85	155
9631-24-400	7314150388752	1	14,87	155
9631-25-400	7314150432066	1	14,50	155
9631-28-400	7314150388776	1	18,04	155
9631-30-400	7314150388783	1	19,10	155
9631-32-400	7314150388790	1	21,62	155
9631-35-400	7314150447596	1	19,69	155
9631-38-400	7314150447602	1	19,83	155
9631-6-400	7314150388646	1	9,67	155
9631-8-400	7314150388677	1	9,67	155
9646-10	7314150388264	1	6,58	155
9646-10-250	7314150388387	1	7,09	155
9646-11	7314150388288	1	7,61	155
9646-12	7314150388295	1	9,70	155
9646-12-250	7314150388400	1	10,23	155
9646-13	7314150388301	1	10,37	155
9646-14	7314150388318	1	12,11	155
9646-15	7314150388325	1	12,82	155
9646-16	7314150388332	1	12,82	155
9646-18	7314150388349	1	19,06	155
9646-20	7314150388356	1	19,06	155
9646-3	7314150388189	1	3,46	155
9646-4	7314150388202	1	3,81	155
9646-5	7314150388219	1	4,15	155
9646-6	7314150388226	1	4,50	155
9646-6-250	7314150388363	1	5,02	155
9646-7	7314150388233	1	4,85	155
9646-8	7314150388240	1	5,55	155
9646-8-250	7314150388370	1	6,07	155
9646-9	7314150388257	1	6,07	155
9646-SET-5	7314150441686	1	10,64	155
9646-SET-8	7314150441693	1	13,80	155
9656-SET-6	7314150486953	1	65,31	155
96C	7314150134120	1	150,69	40
97-1	7314150366637	1	47,62	117
97-1/2	7314150366545	1	28,83	117





97-1/4	7314150366507	1	28,83	117
97-10	7314150366286	1	27,56	117
97-11	7314150366293	1	27,56	117
97-11/16	7314150366583	1	28,83	117
97-12	7314150366309	1	27,56	117
97-13	7314150366316	1	27,56	117
97-13/16	7314150366606	1	45,11	117
97-14	7314150366323	1	27,55	117
97-15	7314150366330	1	27,55	117
97-15/16	7314150366620	1	47,62	117
97-16	7314150366347	1	27,56	117
97-17	7314150366354	1	27,56	117
97-17/32	7314150366552	1	28,83	117
97-18	7314150366361	1	27,56	117
97-19	7314150366378	1	27,56	117
97-21	7314150366385	1	46,20	117
97-22	7314150349722	1	53,22	117
97-24	7314150357048	1	53,22	117
97-27	7314150366392	1	48,76	117
97-3/4	7314150366590	1	28,83	117
97-3/8	7314150366521	1	28,83	117
97-30	7314150366408	1	47,62	117
97-32	7314150366415	1	47,62	117
97-5/16	7314150366514	1	28,83	117
97-5/8	7314150366576	1	28,83	117
97-7	7314150366255	1	27,56	117
97-7/16	7314150366538	1	28,83	117
97-7/8	7314150366613	1	45,11	117
97-8	7314150366262	1	27,56	117
97-9	7314150366279	1	27,56	117
97-9/16	7314150366569	1	28,83	117
9710-10-175	7314151785789	5	11,55	217
9710-3.5-75	7314151785192	10	5,45	217
9710-5.5-100	7314151785352	10	7,24	217
9710-6.5-125	7314151785437	10	8,36	217
9710-8-150	7314151785512	5	9,64	217
9710/S6	7314151802301	1	52,16	217
9715-14-250	7314153010148	5	44,67	218
9733	7314150103256	1	386,68	257
9778-1	7314151793524	10	7,85	217
9778-2	7314151793531	10	10,73	217
9778-3	7314151793548	5	14,48	217
9778PZD-1	7314151823535	10	8,19	217
9778PZD-2	7314151823542	10	11,16	217
97C	7314150128211	1	294,44	40
98-1/2	7314150367481	1	30,08	118
98-1/4	7314150367443	1	30,08	118
98-10	7314150367320	1	30,08	118
98-11	7314150367337	1	30,08	118
98-11/16	7314150367511	1	30,08	118
98-12	7314150367344	1	30,08	118
98-13	7314150367351	1	30,08	118
98-13/16	7314150367535	1	31,33	118
98-14	7314150367368	1	30,08	118
98-15	7314150367375	1	30,08	118
98-16	7314150367382	1	30,08	118
98-17	7314150367399	1	30,08	118
98-18	7314150367405	1	30,08	118
98-19	7314150367412	1	30,08	118
98-21	7314150367429	1	30,08	118
98-22	7314150367436	1	30,08	118
98-3/4	7314150367528	1	30,08	118
98-3/8	7314150367467	1	30,08	118
98-5/16	7314150367450	1	30,08	118
98-5/8	7314150367504	1	30,08	118
98-7	7314150367290	1	30,08	118
98-7/16	7314150367474	1	30,08	118
98-7/8	7314150367542	1	31,33	118
98-8	7314150367306	1	30,08	118
98-9	7314150367313	1	30,08	118
98-9/16	7314150367498	1	30,08	118
981001100	7314150219902	1	1.539,57	450
982000170	7314150219926	1	574,17	464
982000320	7314150219919	1	574,17	464
982000350	7314150219933	1	647,02	464
983000320	7314150219940	1	525,98	441
983100320	7314150219964	1	562,20	441
984010320	7314150219971	1	814,01	441
9841	7314150107445	1	176,37	465
9848	7314150111015	1	159,03	465
98505	7314150216321	5	33,26	215
9852	7314150114092	1	370,64	465
9853	7314150103287	1	80,54	258
9855	7314150111848	1	100,74	655
9857	7314150114283	1	78,72	655
9858	7314150111862	1	29,25	655
9859	7314150113057	1	67,60	655
9860	7314150522859	1	154,72	655
9861	7314150522873	1	68,89	655
9862	7314150522897	1	54,46	655
9863	7314150522910	1	92,23	655
9873	7314150058082	1	54,35	258
9883	7314150043293	1	142,23	571
9897	7314150058068	1	136,33	259
9897G/3	7314150470020	1	81,99	259
9897S/3	7314150470044	1	92,80	503



99-1/2	7314150368150	1	33,84	118
99-10	7314150368013	1	31,33	119
99-11	7314150368020	1	31,33	119
99-11/16	7314150368181	1	35,08	119
99-12	7314150368037	1	31,33	119
99-13	7314150368044	1	31,33	119
99-14	7314150368051	1	31,33	119
99-16	7314150368068	1	32,57	119
99-17	7314150368075	1	32,57	119
99-18	7314150368082	1	32,57	119
99-19	7314150368099	1	32,57	119
99-21	7314150368105	1	32,57	119
99-22	7314150368112	1	32,57	119
99-24	7314150368129	1	36,34	119
99-3/4	7314150368198	1	35,08	119
99-3/8	7314150368136	1	33,84	118
99-5/8	7314150368174	1	33,84	119
99-7/16	7314150368143	1	33,84	118
99-9/16	7314150368167	1	33,84	119
9938	7314150056491	1	216,20	251
9A-14	7314150368204	1	58,89	119
9B-1/4	7314150366071	1	60,13	116
9B-5/16	7314150366088	1	81,44	116
9F-1/2	7314150366194	1	40,09	116
9F-1/4	7314150366170	1	38,85	116
9F-3/8	7314150366187	1	38,85	116
9P-1/2	7314150366057	1	88,96	116
9P-1/4	7314150366033	1	83,96	116
9P-3/8	7314150366040	1	86,46	116
9Q-1/2	7314150366019	1	102,74	116
9Q-1/4	7314150365999	1	97,72	116
9Q-3/8	7314150366002	1	100,24	116
9R-1/2	7314150365913	1	66,41	115
9R-1/4	7314150365890	1	62,64	115
9R-3/8	7314150365906	1	65,16	115
9T-1/2	7314150366118	1	80,18	116
9T-1/4	7314150366095	1	70,17	116
9T-3/8	7314150366101	1	75,18	116
9W	7314150354399	1	40,46	119
A0313M03	7311518023706	1	14,52	144
A0313M03E	7311518192150	1	17,63	144
A0313M03X	7311518182038	1	15,12	144
A0313M03XE	7311518181475	1	17,65	144
A0313M03XE-60	7311518184513	1	22,62	144
A0313M03XE-80	7311518201357	1	22,97	144
A0314I03	7314150501243	5	13,50	147
A0613M03X	7311518197872	1	26,41	144
A0616AL06E	7311518181802	1	34,68	145
A0616M06	7311518023737	1	25,21	144
A0616M06E	7311518023751	1	28,83	144
A0616M06X	7311518023768	1	27,65	144
A0616M06XE	7311518181468	1	28,83	144
A0618I06	7314150501267	5	20,57	147
A0618S06E	7314150501786	5	20,73	146
A0625M06X	7311518197780	1	32,07	146
A0820M06	7311518023805	1	36,89	144
A0820M06E	7311518023829	1	42,74	144
A0820M06X	7311518023836	1	39,31	144
A0820M06XE	7311518181994	1	45,10	144
A1020I06	7314150501304	5	28,94	147
A1020M06	7311518023874	1	42,34	144
A1020M06E	7311518023898	1	48,79	144
A1020M06X	7311518023904	1	44,35	144
A1020M06XE	7311518182007	1	48,79	144
A1020S06	7314150501335	5	26,53	146
A1020S06E	7314150501793	5	29,18	146
A1225AL06E	7311518187620	1	63,71	145
A1225AL08E	7311518181819	1	63,71	145
A1225I06	7314150506729	5	55,42	147
A1225M06	7311518023942	1	53,04	144
A1225M06E	7311518023966	1	61,08	144
A1225M06X	7311518023973	1	59,14	144
A1225M08	7311518100506	1	55,95	144
A1225M08E	7311518100520	1	61,08	144
A1225M08X	7311518187989	1	56,05	144
A1225M08XE	7311518192174	1	64,32	144
A1225S06	7314150501427	5	41,43	146
A1225S06E	7314150501809	5	45,56	146
A1625AL08XE	7311518244033	1	105,39	145
A1625M06	7311518192181	1	66,52	144
A1625M06X	7311518187361	1	69,95	144
A1625M06XE	7311518187354	1	80,46	144
A1625M08	7311518100568	1	66,52	144
A1625M08E	7311518100582	1	80,45	144
A1625M08X	7311518100599	1	69,95	144
A1625M08XE	7311518182021	1	76,42	144
A6700DM-10	7314151821722	5	5,13	79
A6700DM-11	7314151821739	5	5,13	79
A6700DM-12	7314151821746	5	5,13	79
A6700DM-13	7314151821753	5	5,13	79
A6700DM-14	7314151821760	5	5,13	79
A6700DM-5	7314150220632	5	5,13	79
A6700DM-5.5	7314151821678	5	5,13	79
A6700DM-6	7314151821685	5	5,13	79
A6700DM-7	7314151821692	5	5,13	79
A6700DM-8	7314151821708	5	5,13	79



B142.001.150	7314150343188	10	9,57	496
B142.002.100	7314150278732	10	10,15	496
B142.002.175	7314150343195	10	11,82	496
B142.003.150	7314150278749	10	15,29	496
B143.020.100	7314150278510	5	3,97	206
B143.025.100	7314150278503	10	4,07	206
B143.030.100	7314150278527	10	4,13	206
B143.040.100	7314150278534	10	4,80	206
B143.050.100	7314150278541	10	5,84	206
B143.060.125	7314150278558	10	6,70	206
B143.080.150	7314150278565	5	9,60	206
B144.001.100	7314150278787	5	6,90	206
B144.002.125	7314150278794	5	7,39	206
B144.003.150	7314150278800	5	7,71	206
B145.006.100	7314150278756	5	6,58	207
B146.006.100	7314150278763	5	6,92	207
B147.001.400	7314150285594	1	28,29	371
B147.003.400	7314150285600	1	30,98	371
B148.001.080	7314150314522	10	8,15	496
B148.002.100	7314150314539	10	10,02	496
B149.001.080	7314150314546	10	8,46	496
B149.002.100	7314150314553	10	10,34	496
B150.010.100	7314150343126	10	6,29	496
B150.015.125	7314150343133	10	6,33	496
B150.020.125	7314150343140	10	6,46	496
B150.025.150	7314150343157	10	6,68	496
B190.040.075	7314150277810	10	4,72	204
B190.040.100	7314150277827	10	4,77	204
B190.055.100	7314150277834	10	6,04	204
B190.055.125	7314150277841	10	6,16	204
B190.065.125	7314150277858	10	7,57	204
B190.065.150	7314150277865	10	8,62	204
B190.080.150	7314150277872	10	9,47	204
B190.080.175	7314150277889	10	9,73	204
B190.100.200	7314150277896	10	12,77	204
B190.120.250	7314150277902	10	16,58	204
B190.140.250	7314150277919	10	17,66	204
B191.025.075	7314150277926	10	3,40	204
B191.030.075	7314150277933	10	3,50	204
B191.030.100	7314150277940	10	3,75	204
B191.030.200	7314150277957	10	6,02	204
B191.035.100	7314150277964	10	3,86	204
B191.040.100	7314150277971	10	4,42	204
B191.040.125	7314150277988	10	4,85	204
B191.040.250	7314150277995	10	7,25	204
B191.055.125	7314150278008	10	6,14	204
B191.055.150	7314150278015	10	6,87	204
B191.055.300	7314150278022	10	9,27	204
B191.065.150	7314150278039	10	8,10	204
B191.065.300	7314150278046	10	10,63	204
B192.000.075	7314150278084	10	4,66	205
B192.000.200	7314150278091	10	6,71	205
B192.001.100	7314150278107	10	5,72	205
B192.001.250	7314150278114	10	8,56	205
B192.002.125	7314150278121	10	7,12	205
B192.002.150	7314150442720	10	7,51	205
B192.002.300	7314150278138	10	10,78	205
B192.003.150	7314150278145	10	10,96	205
B192.004.200	7314150278169	10	15,17	205
B193.000.075	7314150278190	10	5,54	205
B193.001.100	7314150278206	10	6,21	205
B193.002.125	7314150278213	10	7,57	205
B193.003.150	7314150278220	10	11,54	205
B193.004.200	7314150278237	10	16,08	205
B194.004.075	7314150278268	10	6,58	206
B194.005.075	7314150278275	10	6,38	206
B194.006.075	7314150278282	10	5,93	206
B194.007.075	7314150278299	10	5,97	206
B194.008.075	7314150278305	10	5,99	206
B194.009.075	7314150278312	10	6,01	206
B194.010.075	7314150278329	10	6,02	206
B194.015.100	7314150278336	10	6,14	206
B194.020.100	7314150278343	10	6,21	206
B194.025.125	7314150278350	10	6,62	206
B194.027.125	7314150278367	10	6,79	206
B194.030.150	7314150278374	10	8,13	206
B194.040.150	7314150278381	10	9,80	206
B194.045.150	7314150278398	5	10,52	206
B195.001.025	7314150278176	10	5,93	205
B195.002.025	7314150278183	10	5,93	205
B195.006.050	7314150289493	5	5,93	207
B195.040.025	7314150278053	10	4,42	204
B195.050.025	7314150278060	10	5,68	204
B195.060.025	7314150278077	10	5,93	204
B195.901.025	7314150278244	10	6,26	205
B195.902.025	7314150278251	10	6,67	205
B196.025.075	7314150278589	10	6,00	495
B196.030.100	7314150278572	10	5,90	495
B196.035.100	7314150278596	10	6,14	495
B196.040.100	7314150278602	10	7,16	495
B196.055.125	7314150278619	10	8,53	495
B196.065.150	7314150278626	10	10,92	495
B196.080.175	7314150278633	10	12,05	495
B196.100.200	7314150278640	10	15,76	495
B196.120.200	7314150278657	10	18,27	495
B197.000.075	7314150278664	10	6,13	496



B197.001.080	7314150278671	10	7,57	496
B197.001.150	7314150343164	10	8,56	496
B197.002.100	7314150278688	10	9,78	496
B197.002.175	7314150343171	10	11,76	496
B197.003.150	7314150278695	10	12,52	496
B197.004.200	7314150278701	10	18,54	496
B198.040.125	7314150278817	5	9,56	207
B198.045.125	7314150278824	5	9,56	207
B198.050.150	7314150278831	5	10,06	207
B198.055.150	7314150281268	5	10,06	207
B198.060.150	7314150281763	5	10,52	207
B198.060.150F	7314150281770	5	15,34	207
B198.070.150	7314150281787	5	11,05	207
B198.070.150F	7314150281794	5	15,86	207
B198.080.150	7314150281800	5	13,30	207
B198.080.150F	7314150281817	5	16,94	207
B198.090.150	7314150281824	5	13,56	207
B198.100.150	7314150281831	5	13,95	207
B198.110.150	7314150281848	5	14,34	207
B198.120.150	7314150281855	5	16,19	207
B198.130.150	7314150281862	5	16,57	207
B198.140.150	7314150281879	5	18,16	207
B199.055.125	7314150281886	5	11,27	496
B199.060.125	7314150281893	5	12,29	496
B199.070.125	7314150281909	5	13,17	496
B199.080.125	7314150281916	5	14,55	496
B199.090.125	7314150281923	5	16,16	496
B199.100.125	7314150281930	5	17,87	496
B199.110.125	7314150281947	5	19,56	496
B199.120.125	7314150287741	5	21,82	496
B199.130.125	7314150287772	5	24,21	496
B219.002	7314150289301	1	10,05	200
B219.004	7314150283248	1	23,31	201
B219.005	7314150283255	1	27,20	201
B219.006	7314150283293	1	31,85	202
B219.007	7314150283323	1	42,59	202
B219.008	7314150283347	1	51,62	203
B219.010	7314150283354	1	54,22	204
B219.012	7314150327768	1	12,67	200
B219.014	7314150533985	1	20,60	200
B219.015	7314150283262	1	26,70	201
B219.016	7314150283309	1	32,53	202
B219.017	7314150283330	1	40,67	202
B219.025	7314150283279	1	30,40	201
B219.026	7314150283316	1	33,73	202
B219.027	7314150399833	1	44,03	203
B219.035	7314150283286	1	37,69	201
B219.045	7314150533992	1	23,69	201
B219.110	7314150392667	1	61,55	203
B219.210	7314150438969	1	60,24	203
B220.002	7314150289295	1	13,19	496
B220.005	7314150283361	1	33,98	497
B220.007	7314150283385	1	50,02	497
B220.012	7314150314614	1	22,07	496
B220.015	7314150283378	1	35,05	497
B220.017	7314150283392	1	52,43	497
B220.027	7314150283408	1	46,32	497
B400.002	8412814119441	1	11,33	608
B400.003	8412814119458	1	11,33	608
B400.004	8412814119465	1	11,33	608
B400.005	8412814119472	1	11,33	608
B400.006	8412814119489	1	11,33	608
B400.007	8412814119496	1	11,33	608
B400.008	8412814119502	1	11,33	609
B400.009	8412814119519	1	11,33	609
B400.010	8412814119526	1	11,33	609
B400.011	8412814119533	1	14,26	609
B400.012	8412814119540	1	14,26	609
B400.013	8412814119557	1	14,26	609
B400.014	8412814119564	1	14,26	609
B400.015	8412814119571	1	14,26	609
B400.016	8412814119588	1	14,26	609
B400.017	8412814119595	1	14,26	609
B400.018	8412814119601	1	14,26	609
B400.019	8412814119618	1	14,26	609
B400.020	8412814119625	1	14,26	609
B400.021	8412814119632	1	18,90	609
B400.022	8412814119649	1	18,90	609
B400.023	8412814119656	1	18,90	609
B400.024	8412814119663	1	18,90	609
B400.025	8412814119670	1	18,90	609
B400.026	8412814119687	1	18,90	609
B400.027	8412814119694	1	18,90	609
B400.028	8412814119700	1	18,90	609
B400.029	8412814119717	1	18,90	609
B400.030	8412814119724	1	18,90	609
B400.031	8412814119731	1	24,41	609
B400.032	8412814119748	1	24,41	609
B400.033	8412814119755	1	24,41	609
B400.034	8412814119762	1	24,41	609
B400.035	8412814119779	1	24,41	609
B400.036	8412814119786	1	24,41	609
B400.037	8412814119793	1	24,41	609
B400.038	8412814119809	1	24,41	609
B400.039	8412814119816	1	24,41	609
B400.040	8412814119823	1	24,41	609



B400.041	8412814119830	1	28,71	609
B400.042	8412814119847	1	28,71	609
B400.043	8412814119854	1	28,71	609
B400.044	8412814119861	1	28,71	609
B400.045	8412814119878	1	28,71	609
B400.046	8412814119885	1	28,71	609
B400.047	8412814119892	1	28,71	609
B400.048	8412814119908	1	28,71	609
B400.049	8412814119915	1	28,71	609
B400.050	8412814119922	1	28,71	609
B705.1/4.125	7314150281978	5	12,00	216
BAC007	7314150242337	1	12,12	313
BASIC	7314150437436	1	1.464,04	375
BB10	7314150240586	1	12,18	338
BBA1224-3200	7314150341955	1	3.336,29	337
BBAGM12-1200	7314150535675	1	556,20	337
BBAGM1224-2400	7314150535682	1	1.261,75	337
BBAGMBAT	7314150537709	1	380,07	337
BBAGMCAB	7314150537723	1	20,09	337
BBAGMCHG	7314150537747	1	96,82	337
BBBCAB-AUZ	7314150183944	1	11,82	341
BBBCAB-EU	7314150186648	1	14,01	341
BBBCAB-UK	7314150183937	1	11,82	341
BBC420	7314150243235	1	583,69	338
BBC620	7314150243242	1	835,73	338
BBCE12-10	7314150330263	2	145,92	338
BBCE12-15S	7314150406722	2	177,30	338
BBCE12-3	7314150330249	2	99,50	338
BBCE12-6	7314150330256	2	119,39	338
BBCE12-F100	7314150344710	1	1.406,14	338
BBCE24-10	7314150330287	2	198,99	338
BBCEC1	7314150335459	1	9,82	340
BBCEC2	7314150337460	1	13,21	341
BB CER1	7314150335466	1	9,95	340
BB CER2	7314150337484	1	13,21	341
BBH12-1200	7314150360734	1	908,96	337
BBJL1630	7314150244898	5	41,13	338
BBJL2535	7314150209453	1	95,52	338
BBJL3545	7314150209460	1	127,09	338
BBR100	7314150345922	1	47,13	324
BBR110	7314150170562	1	100,99	325
BBR1501	7314150439119	24	17,29	328
BBR201P6	7314150205752	8	81,19	327
BBR201P64014	7314150237852	1	8,32	327
BBR201P64016	7314150237753	1	8,32	327
BBR201P64018	7314150237760	1	8,55	327
BBR201P67814	7314150237777	1	9,58	327
BBR201P67816	7314150237784	1	9,58	327
BBR201P67818	7314150237791	1	10,47	327
BBR202P4	7314150205769	1	45,76	327
BBR202P410	7314150207688	1	6,80	327
BBR202P414	7314150207695	1	6,80	327
BBR202P419	7314150207701	1	8,32	327
BBR202P455	7314150231393	1	8,32	327
BBR203P9	7314150208081	1	116,63	327
BBR203P920	7314150231102	1	15,47	327
BBR203P925	7314150231119	1	15,47	327
BBR203P927	7314150231126	1	15,47	327
BBR203P930	7314150231133	1	15,47	327
BBR203P940	7314150231140	1	15,47	327
BBR203P945	7314150231157	1	15,47	327
BBR203P950	7314150231164	1	15,47	327
BBR203P955	7314150231171	1	16,38	327
BBR203P960	7314150231188	1	16,38	327
BBR204	7314150430635	6	34,84	328
BBR210P3	7314150206056	1	155,02	327
BBR300P50	7314150269624	4	263,90	327
BBR320	7314150169887	1	100,31	326
BBR350	7314150169900	1	200,63	325
BBR400	7314150345939	1	37,70	326
BBR405	7314150435807	20	197,78	326
BBR410	7314150345946	24	51,15	326
BBR420	7314150403394	50	85,42	326
BBR501011	7314150438143	50	72,04	325
BBR50121314	7314150438150	50	72,04	325
BBR6131	7314150239443	1	32,88	328
BBR6135	7314150239450	1	65,98	327
BBRAS14	7314150416943	4	291,19	325
BBRAS14-01	7314150418060	1	53,95	325
BBRAS14-02	7314150418077	1	26,00	325
BBRAS14-03	7314150418084	1	23,12	325
BBRAS14-04	7314150418091	1	34,65	325
BBRAS14-05	7314150418107	1	7,71	325
BBRAS14-06	7314150418114	1	8,67	325
BBRAS14-07	7314150418121	1	12,53	325
BBRAS14-08	7314150418138	1	14,24	325
BBRAS14-09	7314150418145	1	14,81	325
BBRAS14-10	7314150418152	1	12,07	325
BBRAS14-11	7314150418169	1	65,93	325
BBRAS14-12	7314150418176	1	9,52	325
BBRAS14-13	7314150418183	1	21,60	325
BBRAS14-14	7314150418190	1	10,59	325
BBRBB12	7314150371297	1	1.714,82	325
BBRFKM1	7314150384938	12	187,66	328
BBRPTG1	7314150412617	10	20,58	325
BBRS210P	7314150206070	1	99,37	327



BBRS210P2	7314150206063	1	113,58	327
BBS075	7314150249824	12	40,52	344
BBS100	7314150169870	1	75,40	348
BBS10001	7314150207183	1	7,55	348
BBS10002	7314150207190	1	13,33	348
BBS10003	7314150207206	1	9,07	348
BBS10004	7314150207213	1	20,84	348
BBS10005	7314150207220	1	5,01	348
BBS100057	7314150186655	1	2,18	348
BBS10006	7314150207237	1	3,48	348
BBS10007	7314150207244	1	3,35	348
BBS10008	7314150207251	1	3,48	348
BBS10009	7314150207268	1	3,35	348
BBS10010	7314150207275	1	3,35	348
BBS101	7314150243525	1	30,97	345
BBS102	7314150243518	1	12,38	345
BBS103	7314150243488	1	20,20	345
BBS10450	7314150243501	1	28,01	345
BBS105	7314150250868	1	40,39	345
BBS106	7314150243495	1	19,73	345
BBS107	7314150250875	1	10,72	345
BBS108	7314150250882	1	10,72	345
BBS12SH	7314150243563	1	435,81	346
BBS150	7314150169849	1	129,26	344
BBS150R	7314150244959	1	49,82	345
BBS150S	7314150244973	1	57,90	345
BBS150T	7314150244966	1	63,29	345
BBS165	7314150205615	10	114,46	345
BBS165SP4	7314150205622	50	16,99	346
BBS170P13	7314150205608	1	212,74	346
BBS170P131	7314150231843	1	10,97	346
BBS170P132	7314150231850	1	10,97	346
BBS170P133	7314150231867	1	10,97	346
BBS170P134	7314150231874	1	10,97	346
BBS170P135	7314150231881	1	10,97	346
BBS170P136	7314150231898	1	10,97	346
BBS170P137	7314150231904	1	10,97	346
BBS170P138	7314150231911	1	12,72	346
BBS170P139	7314150231928	1	13,56	346
BBS200	7314150239498	1	43,09	348
BBS200P12	7314150169856	1	61,94	348
BBS210	7314150215362	1	399,91	348
BBS210U06	7314150217656	1	24,01	348
BBS210U08	7314150217663	1	26,15	348
BBS210UA06	7314150217670	1	29,09	348
BBS210UA08	7314150217687	1	32,02	348
BBS210V06	7314150217632	1	24,01	348
BBS210V08	7314150217649	1	26,15	348
BBS210W06	7314150218738	1	31,30	348
BBS210W08	7314150218745	1	34,18	348
BBS3BH1	7314150356843	1	114,46	344
BBS3BH1-VP	7314150355501	40	16,18	344
BBS3UH	7314150242351	1	462,55	344
BBS50	7314150169863	1	55,06	343
BBSDA	7314150247127	1	58,16	347
BBSDC	7314150247158	6	60,42	347
BBSDD	7314150247165	1	45,76	347
BBSDH	7314150247141	1	54,03	347
BBSDHR	7314150249299	1	24,13	347
BBSDT	7314150247134	6	65,73	347
BBSDW	7314150247110	6	45,23	347
BBSHF	7314150247189	1	43,57	346
BBSHM1	7314150247196	1	61,20	346
BBSH2C	7314150247202	1	44,44	346
BBSH2CA	7314150247219	12	49,82	346
BBSH2CP	7314150247226	6	45,13	346
BBSH2F	7314150247172	6	44,44	346
BBSH3CF	7314150247240	6	45,46	346
BBSH3CF30	7314150247264	6	48,35	346
BBSH3FS	7314150247257	6	48,44	346
BBSH3MF	7314150247233	1	47,18	347
BBSHWH1	7314150328932	1	15,48	347
BBSS1	7314150247288	1	103,77	347
BBSS2	7314150247271	8	112,94	347
BBSS2L	7314150247295	1	118,14	347
BBT20	7314150166961	1	98,17	339
BBT60A	7314150504169	36	215,22	339
BBT80	7314150327805	6	608,90	339
BCL31B1	7314150389704	1	56,59	293
BCL31C1	7314150389742	1	83,75	293
BCL31D1	7314150389582	1	167,50	291
BCL31D1K1	7314150400843	1	307,72	291
BCL31IS1	7314150389599	1	192,25	291
BCL31IS1K1	7314150400836	1	332,46	291
BCL31IW1	7314150389551	1	192,25	290
BCL31IW1K1	7314150400829	1	332,46	290
BCL31R1	7314150389568	1	241,41	290
BCL31R1K1	7314150400850	1	381,82	291
BCL31SD1	7314150389575	1	167,50	291
BCL31SD1K1	7314150402656	1	307,85	291
BCL32B1	7314150389711	1	76,39	293
BCL32DG1	7314150389605	1	197,07	292
BCL32DG1K1	7314150402670	1	370,78	292
BCL32G1	7314150389629	1	320,16	293
BCL32G1K1	7314150400911	1	480,29	292
BCL32IW1	7314150389643	1	339,95	290



BCL32IW1K1



BCL32IW1K1	7314150402663	1	490,12	290
BCL32RS1	7314150389636	1	307,85	292
BCL32RS1K1	7314150400904	1	467,99	292
BCL32SP1	7314150389612	1	251,25	292
BCL32SP1K1	7314150400898	1	418,76	292
BCL33AP1	7314150389650	1	332,46	292
BCL33AP1K1	7314150402687	1	615,75	292
BCL33B1	7314150389728	1	110,91	293
BCL33B3	7314150389735	1	169,91	293
BCL33C1	7314150389759	1	96,06	293
BCL33C2	7314150389766	1	120,80	293
BCL33D1	7314150389681	1	270,92	291
BCL33D1K1	7314150400881	1	490,45	291
BCL33IW1	7314150389667	1	394,01	290
BCL33IW1K1	7314150400867	10	677,37	290
BCL33IW2	7314150389674	1	554,21	290
BCL33IW2K1	7314150400874	1	825,13	290
BDACM1000	7314150500819	30	124,65	339
BE-3529	7314151847845	5	18,90	536
BE-6400M-4	7314153011145	5	12,21	194
BE-6400M-5	7314153011169	5	12,89	194
BE-6400M-5.5	7314153011176	5	12,89	194
BE-6400M-7	7314153011190	5	14,15	194
BE-6902	7314150242641	5	4,18	193
BE-6903	7314150242665	5	4,72	193
BE-6925	7314150242658	5	4,25	193
BE-6990-IP10	7314151846763	1	59,83	112
BE-6990-IP10-KL	7314151847531	10	7,51	113
BE-6990-IP15	7314151846770	1	59,83	112
BE-6990-IP15-KL	7314151847548	10	7,51	113
BE-6990-IP20-KL	7314151848668	10	6,05	113
BE-6990-IP6	7314151846725	1	59,83	112
BE-6990-IP6-KL	7314151847494	10	7,51	113
BE-6990-IP7	7314151846732	1	59,83	112
BE-6990-IP7-KL	7314151847500	10	7,51	113
BE-6990-IP8	7314151846749	1	59,83	112
BE-6990-IP8-KL	7314151847517	10	7,51	113
BE-6990-IP9	7314151846756	1	59,83	112
BE-6990-IP9-KL	7314151847524	10	7,51	113
BE-6990-IPSET	7314153019356	1	206,04	113
BE-6990TX-T10KL	7314151847760	10	7,46	113
BE-6990TX-T15KL	7314151847777	10	7,46	113
BE-6990TX-T20KL	7314151848682	10	7,46	113
BE-6990TX-T6-KL	7314151847722	10	7,46	113
BE-6990TX-T7-KL	7314151847739	10	7,46	113
BE-6990TX-T8-KL	7314151847746	10	7,46	113
BE-6990TX-T9-KL	7314151847753	10	7,46	113
BE-7515	7314150242528	5	8,24	192
BE-7520	7314150242535	5	8,43	192
BE-7525	7314150242542	5	8,91	192
BE-7527	7314150242559	5	9,68	192
BE-7530	7314150242566	5	10,39	192
BE-7540	7314150242573	5	11,53	192
BE-7606	7314151839017	5	20,02	195
BE-7607	7314151839024	5	20,30	195
BE-7608	7314151839031	5	21,67	195
BE-7675	7314150123896	1	62,41	228
BE-7715	7314150242580	5	10,30	192
BE-7720	7314150242597	5	10,37	192
BE-7725	7314150242603	5	10,70	192
BE-7727	7314150242610	5	10,83	192
BE-7730	7314150242627	5	11,23	192
BE-7740	7314150242634	5	11,49	192
BE-7803	7314151838867	5	12,21	194
BE-7804	7314151838881	5	12,21	194
BE-7805	7314151838904	5	12,89	194
BE-7806	7314151838928	5	13,49	194
BE-7806S	7314150242986	5	15,97	492
BE-7807	7314151838935	5	14,15	194
BE-7807S	7314150242993	5	17,12	492
BE-7808	7314151838942	5	17,03	194
BE-7808S	7314150243006	5	18,90	492
BE-7809	7314151838959	5	17,36	194
BE-7809S	7314150243013	5	21,02	492
BE-7810	7314151838966	5	17,86	194
BE-7810S	7314150243020	5	23,25	492
BE-7811	7314151838973	5	18,37	194
BE-7812	7314151838980	5	20,73	194
BE-7813	7314151838997	5	21,41	194
BE-7814	7314151839000	5	23,27	194
BE-7835	7314151838874	5	12,21	194
BE-7845	7314151838898	5	12,21	194
BE-7855	7314151838911	5	12,89	194
BE-7855S	7314150242979	5	14,54	492
BE-7907	7314153010964	5	10,55	192
BE-7908	7314153010971	5	10,59	192
BE-7909	7314153010988	5	10,62	192
BE-7910	7314151838799	5	10,66	192
BE-7915	7314151838805	5	10,73	192
BE-7920	7314151838812	5	10,79	192
BE-7925	7314151838829	5	11,23	192
BE-7927	7314151838836	5	11,40	192
BE-7930	7314151838843	5	12,98	192
BE-7940	7314151838850	5	15,17	192
BE-8002	7314150242825	5	3,91	190
BE-8010	7314150010615	5	4,04	190



BE-8010S	7314150033058	5	7,65	492
BE-8020	7314150010639	5	5,74	190
BE-8020I	7314150270316	5	6,69	528
BE-8020L	7314151838591	5	4,47	190
BE-8022	7314150242474	5	4,81	190
BE-8030	7314150010653	5	4,94	190
BE-8030I	7314150270330	5	7,21	528
BE-8040	7314150010677	5	5,65	190
BE-8040I	7314150270347	5	8,26	528
BE-8040S	7314150033089	5	9,28	492
BE-8040SL	7314150304578	10	10,21	494
BE-8050S	7314150033096	5	11,08	492
BE-8050SL	7314150304592	10	12,19	494
BE-8065S	7314150033119	5	15,65	492
BE-8080-1	7314153010995	5	15,20	193
BE-8080-10	7314153011060	5	21,63	193
BE-8080-2	7314153011008	5	15,66	193
BE-8080-3	7314153011015	5	15,66	193
BE-8080-4	7314153011022	5	15,66	193
BE-8080-5	7314153011039	5	15,66	193
BE-8080-6	7314153011046	5	15,66	193
BE-8080-8	7314153011053	5	21,63	193
BE-8135TB	7314150275052	10	8,52	199
BE-8145TB	7314150275076	10	11,22	199
BE-8150	7314150010707	5	7,74	190
BE-8150TB	7314150275113	10	12,98	199
BE-8155	7314150010721	5	9,71	190
BE-8155TB	7314150275090	5	15,25	199
BE-8158	7314153010858	5	12,54	190
BE-8159	7314153010865	5	14,75	190
BE-8160	7314150010745	5	14,39	190
BE-8210	7314151838584	5	4,34	190
BE-8220	7314150047741	5	6,52	190
BE-8220S	7314150048243	5	7,65	492
BE-8220SL	7314150304530	10	8,43	494
BE-8225	7314150242443	5	7,70	190
BE-8230	7314150047758	5	6,21	190
BE-8230S	7314150048250	5	7,98	492
BE-8230SL	7314150304554	10	8,78	494
BE-8235	7314150242450	5	7,93	190
BE-8240	7314150047765	5	9,28	190
BE-8241	7314150242467	5	7,86	190
BE-8241I	7314150270866	5	10,50	528
BE-8242	7314153010803	5	8,79	190
BE-8250	7314150047772	5	10,63	190
BE-8250L	7314151838607	5	11,88	190
BE-8251	7314150242481	5	9,60	190
BE-8252	7314153010810	5	10,37	190
BE-8252I	7314150270361	5	14,61	528
BE-8255	7314150047789	5	11,03	190
BE-8255S	7314150048281	5	14,17	492
BE-8255SL	7314150304615	10	15,60	494
BE-8256	7314153010827	5	12,12	190
BE-8256TB	7314150275137	10	20,19	199
BE-8257	7314153010834	5	12,45	190
BE-8258	7314153010841	5	16,36	190
BE-8258S	7314150242818	5	20,46	492
BE-8258TB	7314150275151	10	24,34	199
BE-8259S	7314150242832	5	23,78	492
BE-8260	7314150047796	5	16,72	190
BE-8262TB	7314150275526	10	29,23	199
BE-8330	7314151838614	5	5,29	190
BE-8340	7314151838621	5	5,65	190
BE-8350	7314151838638	5	7,25	190
BE-8355	7314151838652	5	7,58	191
BE-8360	7314151838676	5	8,70	191
BE-8450	7314151838645	5	7,83	190
BE-8455	7314151838669	5	9,07	191
BE-8510S	7314150126507	5	9,80	492
BE-8510SL	7314150304813	10	10,78	494
BE-8520S	7314150126514	5	13,35	492
BE-8520SL	7314150304837	10	14,69	494
BE-8571	7314150244652	1	63,59	197
BE-8572	7314150244669	1	67,44	197
BE-8573	7314150244676	1	65,53	198
BE-8574	7314150258666	1	66,09	198
BE-8575	7314150244638	1	19,92	195
BE-8576	7314150245741	1	130,47	198
BE-8577	7314151839048	5	15,34	195
BE-8600	7314150010769	5	5,97	191
BE-8600I	7314150270378	5	8,10	528
BE-8600S	7314150033126	5	7,97	492
BE-8601	7314151838706	5	7,84	191
BE-8602	7314151838713	5	7,84	191
BE-8605	7314150242498	5	6,13	191
BE-8608	7314150242504	5	8,60	191
BE-8610	7314150010776	5	7,33	191
BE-8610I	7314150270392	5	10,03	528
BE-8610L	7314151838683	5	10,97	191
BE-8610S	7314150033133	5	9,86	492
BE-8610SL	7314150304639	10	10,84	494
BE-8610TB	7314150275199	10	13,83	199
BE-8611	7311518292317	5	7,24	191
BE-8611S	7314150414703	5	9,84	492
BE-8612S	7314150242856	5	11,24	492
BE-8620	7314150010783	5	8,19	191

			€	
BE-8620I	7314150270408	5	14,07	528
BE-8620L	7314151838690	5	13,80	191
BE-8620S	7314150033140	5	12,70	492
BE-8620SL	7314150304653	10	13,99	494
BE-8620TB	7314150275212	10	15,35	199
BE-8621	7311518292324	5	8,04	191
BE-8621S	7314150242863	5	15,41	492
BE-8622	7314150242511	5	9,14	191
BE-8622S	7314150242870	5	15,45	492
BE-8623	7314153010872	5	14,03	191
BE-8623I	7314150270415	5	21,27	528
BE-8623TB	7314150275236	10	20,46	199
BE-8624	7314153010889	5	19,43	191
BE-8624TB	7314150275250	10	29,78	199
BE-8628	7314153010896	5	9,73	191
BE-8629	7314153010902	5	12,35	191
BE-8630	7314150010790	5	16,91	191
BE-8630S	7314150033157	5	16,29	492
BE-8640	7314150010806	5	22,52	191
BE-8640S	7314150033164	5	24,11	492
BE-8675	7314150123872	1	75,09	228
BE-8700-1/4	7314150242689	5	10,06	193
BE-8700-3/16	7314150242696	5	7,98	193
BE-8700-3/8	7314150242702	5	18,16	193
BE-8700-5/16	7314150242719	5	14,20	193
BE-8700-5/32	7314150242726	5	6,23	193
BE-8700-7/32	7314150242733	5	8,58	193
BE-8700-7/64	7314150275878	5	8,87	193
BE-8702	7314151838768	5	5,11	193
BE-8703	7314150027651	5	5,29	193
BE-8703S	7314151839130	5	6,57	492
BE-8704	7314150027668	5	6,02	193
BE-8704S	7314151839147	5	7,99	492
BE-8705	7314150027675	5	7,47	193
BE-8705S	7314151839154	5	9,04	492
BE-8706	7314150027682	5	8,58	193
BE-8706S	7314151839161	5	9,51	492
BE-8708	7314150027699	5	12,28	193
BE-8708S	7314151839178	5	12,80	492
BE-8710	7314150027705	5	13,86	193
BE-8710S	7314150126521	5	10,67	492
BE-8710SL	7314150304851	10	11,74	494
BE-8715	7314150242672	5	4,93	193
BE-8720S	7314150126538	5	14,43	492
BE-8720SL	7314150304875	10	15,88	494
BE-8725	7314151838775	5	5,22	193
BE-8725S	7314151839123	5	6,30	492
BE-8800	7314150042012	5	7,12	191
BE-8800I	7314150270422	5	10,00	528
BE-8800S	7314151839055	5	8,85	492
BE-8801	7314151838744	5	8,03	192
BE-8802	7314151838751	5	8,03	192
BE-8810	7314150010813	5	7,96	191
BE-8810I	7314150270439	5	11,59	528
BE-8810L	7314151838720	5	9,26	191
BE-8810S	7314150048298	5	10,58	492
BE-8810SL	7314150304677	10	11,65	494
BE-8810TB	7314150275274	10	12,40	199
BE-8811	7311518292331	5	7,24	191
BE-8811S	7314150414710	5	10,58	492
BE-8812S	7314150242894	5	12,53	492
BE-8820	7314150010820	5	9,71	191
BE-8820I	7314150270446	5	15,29	528
BE-8820L	7314151838737	5	19,76	191
BE-8820S	7314150048304	5	13,20	492
BE-8820SL	7314150304691	10	14,51	494
BE-8820TB	7314150275298	10	17,56	199
BE-8821	7311518292348	5	16,37	191
BE-8821S	7314150242900	5	13,69	492
BE-8822S	7314150242917	5	15,50	492
BE-8823	7314153010919	5	14,77	191
BE-8823I	7314150270453	5	22,35	528
BE-8823TB	7314150275311	10	22,99	199
BE-8824	7314153010926	5	20,60	191
BE-8824TB	7314150275335	10	32,05	199
BE-8828	7314153010933	5	11,93	191
BE-8829	7314153010940	5	15,34	191
BE-8830	7314150010837	5	14,81	191
BE-8830S	7314150048311	5	19,87	492
BE-8840	7314150010844	5	19,38	191
BE-8840S	7314151839062	5	22,81	492
BE-8865	7314150010851	5	17,09	190
BE-8870	7314150010875	5	18,40	190
BE-8880	7314150010899	5	23,49	190
BE-8890	7314150010905	5	29,70	190
BE-8904	7314153010957	5	7,51	192
BE-8905	7314153010049	5	7,51	192
BE-8905S	7314150242924	5	8,00	492
BE-8906	7314150027729	5	7,58	192
BE-8906S	7314150242931	5	8,00	492
BE-8907	7314150027736	5	7,63	192
BE-8907S	7314150242948	5	8,00	492
BE-8908	7314150027743	5	7,66	192
BE-8908S	7314150242955	5	8,00	492
BE-8909	7314150027750	5	7,69	192
BE-8909S	7314150242962	5	8,00	492

			€	
BE-8910	7314150027767	5	7,70	192
BE-8910I	7314150270460	5	9,79	528
BE-8910S	7314151839079	5	8,26	492
BE-8910SL	7314150304714	5	9,08	494
BE-8910TB	7314150275359	5	8,03	200
BE-8915	7314150027774	5	7,86	192
BE-8915I	7314150270477	5	9,87	528
BE-8915S	7314151839086	5	8,32	492
BE-8915SL	7314150304738	5	9,16	494
BE-8915TB	7314150275373	5	10,89	200
BE-8920	7314150027781	5	7,96	192
BE-8920I	7314150270484	5	10,00	528
BE-8920S	7314151839093	5	8,47	492
BE-8920SL	7314150304752	5	9,32	494
BE-8920TB	7314150275397	5	11,08	200
BE-8925	7314150027798	5	8,49	192
BE-8925I	7314150270491	5	10,67	528
BE-8925S	7314151839109	5	8,78	492
BE-8925SL	7314150304776	5	9,66	494
BE-8925TB	7314150275410	5	11,78	200
BE-8927	7314150027804	5	8,71	192
BE-8927TB	7314150275434	5	12,88	200
BE-8930	7314150027811	5	10,41	192
BE-8930S	7314151839116	5	11,34	492
BE-8930SL	7314150304790	5	12,49	494
BE-8930TB	7314150275458	5	13,53	200
BE-8940	7314150027828	5	12,55	192
BE-8940TB	7314150275472	5	15,28	200
BE-8945	7314151838782	5	13,49	192
BE-8975	7314150056576	6	41,81	227
BE-8975B	7314150188741	6	41,81	227
BE-8976B	7314150216369	6	47,49	228
BE-8980	7314153010681	5	8,87	194
BE-8985	7314153010698	5	8,43	194
BE-8986	7314150267026	5	8,77	194
BE-9001	7311518269005	5	8,82	193
BE-9002	7311518269012	5	9,48	193
BE-9003	7311518269029	5	9,87	193
BE-9100	7314150242757	5	9,35	193
BE-9101	7314150242764	5	9,35	193
BE-9102	7314150242771	5	9,35	193
BE-9103	7314150242788	5	9,35	193
BE-9104	7314150242795	5	10,73	193
BE-9105	7314150242801	5	10,73	193
BE-9575	7314150123841	1	46,06	227
BE-9578	7314150123803	1	13,04	224
BE-9585	7314150123858	1	48,85	227
BE-9586	7314150216000	1	10,06	224
BE-9588	7314150123810	1	20,67	225
BE-9675	7314150123889	1	67,02	227
BE-9676	7314150216017	1	17,43	225
BE-9678	7314150123827	1	32,28	225
BE-9688	7314150123834	1	34,47	225
BE-9765	7314150055128	3	10,75	225
BE-9770	7314150027712	3	17,72	225
BE-9770I	7314150276332	20	33,68	528
BE-9775	7314150056330	3	15,89	226
BE-9776	7314150056545	6	18,06	224
BE-9776B	7314150216352	6	34,92	225
BE-9777	7314150056552	6	24,49	224
BE-9777B	7314150188734	6	23,49	224
BE-9780	7314150033386	3	29,29	226
BE-9785	7314150056347	3	27,13	226
BE-9786I	7314150314485	1	41,86	529
BE-9787	7314150056569	6	25,91	224
BE-9871	7314150234707	1	45,01	189
BE-9871SL	7314150470792	1	53,62	495
BE-9872	7314150440412	1	74,76	189
BE-9872SL	7314150470785	1	54,77	495
BE-9875	7314150314447	1	100,25	189
BE-9876S	7314150315000	1	113,74	494
BE-9877	7314150320745	1	108,65	190
BE-9878	7314150186259	1	14,44	222
BE-9878SL	7314150321018	1	107,89	495
BE-9879	7314150383474	1	80,98	189
BE-9880	7314150238569	3	38,37	223
BE-9880SL	7314150337651	1	42,85	495
BE-9881	7314150043279	1	42,41	188
BE-9881I	7314150270507	1	57,20	528
BE-9881S	7314151839307	1	44,18	493
BE-9881SL	7314150304899	1	48,59	495
BE-9881TB	7314150275502	1	56,70	198
BE-9882	7314151839284	1	44,13	188
BE-9882I	7314150270514	1	59,69	528
BE-9882S	7314151839314	1	45,58	493
BE-9882SL	7314150304912	1	50,14	495
BE-9882TB	7314150275496	1	59,39	199
BE-9884	7314150243068	1	45,99	188
BE-9884S	7314150236602	1	64,77	493
BE-9885	7314150048465	1	40,50	188
BE-9885S	7314150126491	1	47,06	493
BE-9885TB	7314150275519	1	52,23	199
BE-9886	7314150048472	1	44,94	188
BE-9887S	7314150244744	1	60,22	493
BE-9888S	7314153006158	1	65,00	493
BE-9889S	7314150244751	1	55,37	493



BE-9890S



BE-9890S	7314150237715	1	24,13	493
BE-9890SL	7314150315086	1	26,56	494
BE-9891SL	7314150321506	1	23,87	494
BE-9894SL	7314150321490	1	25,16	495
BE1100	7314150205929	8	324,81	309
BE110001	7314150230228	1	60,93	309
BE110014	7314150230204	1	20,92	308
BE110015	7314150230211	1	102,28	308
BE1100AC1	7314150230266	1	68,12	308
BE1100AC2	7314150333394	1	21,21	308
BE1200P6	7314150205516	1	152,72	306
BE1200P6AC1	7314150205523	1	108,56	306
BE1205	7314150205554	1	80,79	306
BE1210P11	7314150209101	1	157,54	307
BE1210P1101	7314150269822	1	12,58	306
BE1210P1102	7314150269839	1	13,57	306
BE1210P1103	7314150269846	1	13,57	306
BE1210P9AC1	7314150205547	1	107,75	307
BE1300	7314150205578	1	95,60	305
BE1300SH	7314150205585	10	49,82	305
BE1305P450	7314150206032	1	333,91	305
BE1305P450WS01	7314150269228	1	24,55	305
BE1305P450WS02	7314150269235	1	13,24	305
BE1305P450WS03	7314150269242	1	20,92	305
BE1305P450WS04	7314150269327	1	25,05	305
BE1305P450WS05	7314150269334	1	28,63	305
BE1305P450WS06	7314150269341	1	32,75	305
BE1305P450WS07	7314150269358	1	20,33	305
BE1305P450WS08	7314150269365	1	21,53	305
BE1305P450WS09	7314150269372	1	26,25	305
BE1305P450WS10	7314150269310	1	28,63	305
BE1305P450WS11	7314150269389	1	29,16	305
BE1305P450WS12	7314150269396	1	17,41	305
BE1305P450WS13	7314150269402	1	13,24	305
BE1305P450WS14	7314150269419	1	13,24	305
BE1305P450WS15	7314150269426	1	29,16	305
BE1310P4	7314150205707	1	114,46	304
BE1310P425	7314150233649	1	27,49	304
BE1310P427	7314150233656	1	30,09	304
BE1310P429	7314150233663	1	32,47	304
BE1310P430	7314150233670	1	32,47	304
BE1311P13	7314150235414	1	422,79	304
BE1312DNS	7314150450596	12	11,44	305
BE1315P7	7314150205776	1	121,04	305
BE1315P71	7314150230273	1	23,45	305
BE1315P72	7314150230280	1	19,67	305
BE1315P73	7314150230297	1	24,36	305
BE1315P74	7314150230303	1	23,81	305
BE1315P75	7314150230310	1	23,81	305
BE1315P76	7314150230327	1	24,36	305
BE1315P77	7314150230334	1	26,88	305
BE1320S17	7314150415366	10	118,63	304
BE13ZL11	7314150239733	1	605,90	306
BE1FFWF	7314150403325	12	23,56	315
BE1FLD1	7314150250745	1	16,30	315
BE1FLD2	7314150250752	1	16,30	315
BE1FLD3	7314150250769	1	16,30	315
BE1FLDS	7314150250783	1	44,44	315
BE1FTW	7314150251209	1	67,86	315
BE1GP5	7314150170043	1	65,01	306
BE1GP5-T	7314150170050	10	29,17	306
BE1GP510	7314150207732	1	22,52	307
BE1GP512	7314150207749	1	22,52	307
BE1GP514	7314150207756	1	22,52	307
BE1GP58	7314150207718	1	22,52	307
BE1GP59	7314150207725	1	22,52	307
BE1P	7314150170067	1	76,05	307
BE1SP14L	7314150170074	1	26,80	307
BE1SP16L	7314150492756	10	26,80	307
BE1SP1F	7314150435777	12	28,52	307
BE1T14	7314150167630	1	34,74	307
BE1T16	7314150167647	1	39,72	307
BE1T21	7314150167654	1	39,14	307
BE1TH-10	7314150343980	5	29,95	316
BE1TH-12	7314150343997	5	36,37	316
BE1TH-2	7314150343874	10	17,23	316
BE1TH-2.5	7314150343881	10	17,23	316
BE1TH-3	7314150343898	10	17,70	316
BE1TH-3.5	7314150343904	10	17,70	316
BE1TH-4	7314150343911	10	20,13	316
BE1TH-4.5	7314150343928	10	20,86	316
BE1TH-5	7314150343935	10	21,54	316
BE1TH-6	7314150343942	10	23,84	316
BE1TH-7	7314150343959	10	27,42	316
BE1TH-8	7314150343966	10	27,42	316
BE1TH-9	7314150343973	10	29,95	316
BE1TH-S5	7314150457502	1	88,76	315
BE1TH-S6	7314150344017	30	99,64	315
BE1TS-10	7314150344062	10	29,62	316
BE1TS-11	7314150344079	10	29,88	316
BE1TS-12	7314150344086	10	30,69	316
BE1TS-13	7314150344093	10	31,37	316
BE1TS-14	7314150344109	10	31,37	316
BE1TS-15	7314150344116	10	34,00	316
BE1TS-16	7314150344123	10	34,00	316
BE1TS-17	7314150344130	10	34,00	316



BE1TS-18	7314150344147	10	37,16	316
BE1TS-19	7314150344154	10	37,16	316
BE1TS-20	7314150344161	8	43,90	316
BE1TS-21	7314150344178	8	24,56	316
BE1TS-22	7314150344185	8	44,03	316
BE1TS-24	7314150344192	8	40,26	316
BE1TS-6	7314150344024	10	25,86	316
BE1TS-7	7314150344031	10	25,86	316
BE1TS-8	7314150344048	10	28,42	316
BE1TS-9	7314150344055	10	29,62	316
BE1TS-S7	7314150344208	1	187,94	316
BE200CAB250SH10	7314150165452	1	2.526,98	360
BE200CAB250SH25	7314150165469	1	3.497,70	360
BE200CAB250SH3	7314150165445	1	1.684,68	360
BE200CAB40F1	7314150165391	1	1.099,04	360
BE200CAB55F1	7314150165407	1	770,13	360
BE200CAB55F3	7314150165414	1	1.018,83	360
BE200CAB58SR1	7314150165421	1	786,19	360
BE200CAB58SR3	7314150165438	1	1.042,90	360
BE200CAB80SR1	7314150165384	1	410,50	360
BE200CAB80SR3	7314150165476	1	788,05	360
BE200MAG4	7314150245192	1	70,02	360
BE200MAG5	7314150165513	1	75,40	360
BE200MAG80	7314150165551	1	74,10	360
BE200MIR4035	7314150245161	1	67,13	360
BE200MIR4055	7314150245185	1	67,13	360
BE200MIR5535	7314150165483	1	75,41	360
BE200MIR5545	7314150165490	1	75,41	360
BE200MIR5555	7314150165506	1	75,41	360
BE200MIR8035	7314150165520	1	74,10	360
BE200MIR8045	7314150165537	1	74,10	360
BE200MIR8055	7314150165544	1	74,10	360
BE220	7314150170005	1	242,36	360
BE230	7314150182633	1	179,00	303
BE239	7314150243143	1	94,25	303
BE240	7314150239917	1	992,74	303
BE240-CAT	7314150289417	1	107,72	303
BE250	7314150169924	1	47,13	313
BE251200	7314150249343	1	99,64	334
BE2512005	7314150249350	1	78,10	333
BE2512008	7314150249367	1	83,48	334
BE251A	7314150540136	12	47,13	313
BE253	7314150250806	1	119,84	313
BE2541	7314150251797	1	16,58	314
BE2542	7314150251803	1	6,33	314
BE254A	7314150446070	1	112,93	314
BE254A-01	7314150453405	1	41,05	314
BE256-155	7314150205875	1	9,43	314
BE256-178	7314150205882	1	12,12	314
BE256-250	7314150205899	1	16,15	314
BE256M	7314150205851	1	45,76	314
BE256P3	7314150205868	1	33,67	314
BE257	7314150205844	8	103,36	304
BE25710	7314150230549	1	17,11	304
BE25718	7314150230532	1	17,11	304
BE2572	7314150230556	1	12,13	304
BE2576	7314150230525	1	15,04	304
BE258	7314150251780	1	124,62	314
BE301	7314150430871	2	456,77	335
BE301CM	7314150430888	50	62,80	335
BE301CM-01	7314150430956	20	32,35	335
BE301CM-02	7314150430963	20	32,35	335
BE310	7314150205943	8	80,79	336
BE400P24	7314150205806	1	424,13	309
BE400P2401	7314150230600	1	27,90	310
BE400P2402	7314150230617	1	27,90	310
BE400P2403	7314150230624	1	24,68	310
BE400P2404	7314150230631	1	16,08	310
BE400P2405	7314150230648	1	16,08	310
BE400P2406	7314150230655	1	16,08	310
BE400P2407	7314150230662	1	16,08	310
BE400P2408	7314150230679	1	16,08	311
BE400P2409	7314150230686	1	16,08	311
BE400P241	7314150230563	1	113,96	309
BE400P2410	7314150230693	1	16,08	311
BE400P2411	7314150230709	1	16,08	311
BE400P2412	7314150230716	1	16,08	311
BE400P2413	7314150230723	1	16,08	311
BE400P2414	7314150230730	1	16,08	311
BE400P2415	7314150230747	1	17,29	311
BE400P2416	7314150230754	1	16,99	311
BE400P2417	7314150230761	1	16,99	312
BE400P2418	7314150230778	1	16,99	312
BE400P2419	7314150230785	1	16,99	312
BE400P242	7314150230570	1	11,59	309
BE400P2420	7314150237647	1	42,89	312
BE400P243	7314150230587	1	11,59	310
BE400P244	7314150230594	1	22,44	310
BE401	7314150240593	1	10,69	309
BE410	7314150205813	4	263,90	312
BE4101	7314150230792	1	11,58	312
BE5008	7314150239344	1	102,21	306
BE5008-10	7314150239269	1	15,75	306
BE5008-15	7314150239276	1	15,75	306
BE5008-20	7314150239283	1	15,75	306
BE5008-25	7314150239290	1	15,75	306



BE5008-27	7314150239306	1	15,75	306
BE5008-30	7314150239313	1	15,75	306
BE5008-40	7314150239320	1	15,75	306
BE5008-45	7314150239337	1	15,75	306
BE500P24	7314150169955	5	148,11	303
BE500P2401	7314150209569	1	11,56	303
BE500P2402	7314150209682	1	11,26	303
BE500P2403	7314150209736	1	12,52	303
BE500P2404	7314150209729	1	12,68	303
BE500P2405	7314150209613	1	13,51	303
BE500P2406	7314150209804	1	17,44	303
BE500P2407	7314150209781	1	17,44	303
BE500P2408	7314150209743	1	6,53	303
BE500P2409	7314150209750	1	6,47	303
BE500P2410	7314150209637	1	6,47	303
BE500P2411	7314150209644	1	6,47	303
BE500P2412	7314150209699	1	6,47	303
BE500P2413	7314150209705	1	6,47	303
BE500P2414	7314150209798	1	17,60	303
BE500P2415	7314150209675	1	11,96	303
BE500P2416	7314150209620	1	11,31	303
BE500P2417	7314150209583	1	11,12	303
BE500P2418	7314150209576	1	11,56	303
BE500P2419	7314150209767	1	11,12	303
BE500P2420	7314150209590	1	11,56	303
BE500P2421	7314150209606	1	11,56	303
BE500P2422	7314150209774	1	17,44	303
BE500P2423	7314150209668	1	11,26	303
BE500P2424	7314150209712	1	11,26	303
BE501101	7314150274499	1	156,18	296
BE501102	7314150274505	1	157,94	296
BE501203	7314150274529	1	141,37	296
BE501204	7314150274536	1	214,08	296
BE502101	7314150274543	1	468,33	296
BE502102	7314150274550	1	436,74	297
BE502103	7314150274567	1	752,61	297
BE502104	7314150384952	8	110,01	296
BE502106	7314150403370	10	51,77	296
BE502204	7314150274574	1	188,49	297
BE5032	7314150189885	1	90,95	312
BE503201	7314150274581	1	166,96	297
BE5032H10EL	7314150220953	1	10,74	317
BE5032H14	7314150220960	1	31,45	316
BE5032M14	7314150220977	1	35,39	317
BE5032SQ10	7314150220991	1	29,94	312
BE5032SQ8	7314150220984	1	24,77	312
BE5032T55EL	7314150220946	1	11,85	318
BE504102	7314150274666	1	441,63	297
BE504201	7314150274369	1	80,79	297
BE5049	7314150169931	5	114,46	316
BE504901	7314150184576	1	12,35	316
BE504902	7314150184583	1	10,07	317
BE5049H10	7314150184705	1	14,92	316
BE5049H10L	7314150184712	1	22,12	317
BE5049H12	7314150184729	1	18,57	316
BE5049H12L	7314150184736	1	29,69	317
BE5049H4	7314150184590	1	14,92	316
BE5049H4L	7314150184606	1	22,12	317
BE5049H5	7314150184613	1	14,92	316
BE5049H5L	7314150184620	1	22,12	317
BE5049H6	7314150184637	1	14,92	316
BE5049H6L	7314150184651	1	22,12	317
BE5049H7	7314150184668	1	14,92	316
BE5049H7L	7314150184675	1	22,12	317
BE5049H8	7314150184682	1	14,92	316
BE5049H8L	7314150184699	1	22,12	317
BE5049M10	7314150184804	1	14,92	317
BE5049M10L	7314150184811	1	22,12	317
BE5049M12	7314150184828	1	18,57	317
BE5049M12L	7314150184835	1	29,69	317
BE5049M5	7314150184743	1	14,92	317
BE5049M5L	7314150184750	1	22,12	317
BE5049M6	7314150184767	1	14,92	317
BE5049M6L	7314150184774	1	22,12	317
BE5049M8	7314150184781	1	14,92	317
BE5049M8L	7314150184798	1	22,12	317
BE5049T	7314150325474	1	114,46	318
BE5049T20	7314150216048	1	14,42	317
BE5049T20H	7314150184842	1	14,92	317
BE5049T20HL	7314150184859	1	22,12	318
BE5049T20L	7314150221011	1	21,60	318
BE5049T25	7314150216055	1	14,42	317
BE5049T25H	7314150184866	1	14,92	317
BE5049T25HL	7314150184873	1	22,12	318
BE5049T25L	7314150221028	1	21,60	318
BE5049T27	7314150216062	1	14,42	317
BE5049T27H	7314150184880	1	14,92	317
BE5049T27HL	7314150184897	1	22,12	318
BE5049T27L	7314150221035	1	21,60	318
BE5049T30	7314150216079	1	14,42	317
BE5049T30H	7314150184903	1	14,92	317
BE5049T30HL	7314150184910	1	22,12	318
BE5049T30HXL	7314150184927	1	22,22	318
BE5049T30L	7314150221042	1	21,60	318
BE5049T40	7314150216086	1	14,42	317
BE5049T40H	7314150184934	1	14,92	317



BE5049T40HL	7314150184941	1	22,12	318
BE5049T40HXL	7314150185092	1	22,22	318
BE5049T40L	7314150221059	1	21,60	318
BE5049T45	7314150216093	1	14,42	317
BE5049T45H	7314150184958	1	14,92	317
BE5049T45HL	7314150184965	1	22,12	318
BE5049T45HXL	7314150184972	1	22,22	318
BE5049T45L	7314150216123	1	21,60	318
BE5049T50	7314150216109	1	14,42	317
BE5049T50H	7314150184989	1	14,92	317
BE5049T50HL	7314150184996	1	22,12	318
BE5049T50L	7314150221066	1	21,60	318
BE5049T55	7314150216116	1	14,42	317
BE5049T55H	7314150185009	1	14,92	317
BE5049T55HL	7314150185016	1	22,12	318
BE5049T55L	7314150221073	1	21,60	318
BE5049T60	7314150221004	1	21,12	317
BE5049T60H	7314150185023	1	21,60	317
BE5049T60HL	7314150185030	1	32,34	318
BE5049T70HL	7314150185047	1	32,34	318
BE5049T80HL	7314150186532	1	32,34	318
BE505101	7314150274598	1	156,18	298
BE505102	7314150274604	1	677,07	298
BE505203	7314150274611	1	242,36	298
BE505204	7314150274628	1	231,58	298
BE506101	7314150274376	1	210,12	298
BE506102	7314150274635	1	185,40	298
BE506103	7314150274642	1	495,78	299
BE506204	7314150274659	1	288,41	299
BE507101	7314150274673	1	384,55	299
BE507102	7314150274680	1	410,63	299
BE507203	7314150274697	1	403,93	299
BE508101	7314150274765	1	234,29	300
BE508202	7314150274772	1	315,07	300
BE508203	7314150274703	1	296,64	300
BE508204	7314150274710	1	421,63	300
BE509101	7314150274727	1	274,68	300
BE509102	7314150274734	1	458,71	300
BE509103	7314150274383	1	79,45	301
BE509104	7314150274741	1	479,31	301
BE509205	7314150274390	1	70,02	301
BE509206	7314150274406	1	71,38	301
BE509207	7314150274758	1	282,76	301
BE5100	7314150205646	1	95,67	303
BE5101	7314150205721	1	95,96	317
BE510101	7314150274420	1	240,34	301
BE510102	7314150274437	1	53,60	301
BE510125	7314150230877	1	7,08	312
BE510127	7314150230884	1	7,08	312
BE510130	7314150230891	1	7,08	312
BE510140	7314150230907	1	7,08	313
BE510145	7314150230914	1	7,43	313
BE510150	7314150230921	1	7,43	313
BE510155	7314150230938	1	7,43	313
BE510160	7314150230945	1	8,89	313
BE5102	7314150205738	1	95,96	308
BE510203	7314150274789	1	186,78	302
BE510210	7314150231003	1	8,25	308
BE510211	7314150231010	1	9,63	308
BE510212	7314150231027	1	10,01	308
BE510213	7314150231034	1	12,37	308
BE51025	7314150230952	1	7,87	308
BE51026	7314150230969	1	7,87	308
BE51027	7314150230976	1	7,87	308
BE51028	7314150230983	1	8,25	308
BE51029	7314150230990	1	8,25	308
BE5103	7314150205745	1	85,62	308
BE510304	7314150274444	1	116,74	302
BE510310	7314150231072	1	8,21	308
BE510312	7314150231089	1	9,94	308
BE510314	7314150231096	1	13,62	308
BE51035	7314150231041	1	8,21	308
BE51036	7314150231058	1	8,21	308
BE51038	7314150231065	1	8,21	308
BE511101	7314150274451	1	79,65	302
BE511102	7314150274468	1	63,17	302
BE511203	7314150274796	1	336,61	302
BE512201	7314150274475	1	2.181,26	304
BE513201	7314150274802	1	531,85	302
BE5150P27	7314150205790	1	370,90	313
BE5150P271	7314150230808	1	123,06	313
BE5150P272	7314150230815	1	34,37	313
BE5150P273	7314150230822	1	224,42	313
BE5200	7314150205905	1	200,63	317
BE52001	7314150230433	1	22,84	317
BE52002	7314150230440	1	22,84	317
BE52003	7314150230457	1	104,45	317
BE523106	7314150178391	1	62,01	302
BE530001	7314150205912	1	167,26	317
BE5350	7314150206049	5	262,57	305
BE5350C1	7314150230389	1	40,00	305
BE5350C2	7314150230396	1	40,00	305
BE5350C3	7314150230402	1	40,00	305
BE5350C4	7314150230419	1	20,68	305
BE5350C5	7314150230426	1	168,80	305
BE5400P	7314150245086	1	181,78	303



BE5401D



BE5401D	7314150245062	1	658,42	303
BE5500	7314150403233	25	53,06	314
BE550010	7314150432936	1	9,84	315
BE550011	7314150432943	1	9,84	315
BE550012	7314150432950	1	9,84	315
BE550014	7314150432967	1	9,84	315
BE550017	7314150432974	1	10,29	315
BE550019	7314150432981	1	10,61	315
BE61110	7314150167449	12	35,59	319
BE61110-1	7314150167463	100	5,93	319
BE61155	7314150167456	12	38,48	319
BE61155-1	7314150167470	1	7,70	319
BE62110	7314150403332	10	38,18	319
BE62155	7314150403349	10	41,41	319
BE6217	7314150169702	1	82,14	321
BE621701	7314150232642	1	6,42	321
BE621702	7314150232659	1	6,42	321
BE621703	7314150232666	1	6,42	321
BE621704	7314150232673	1	6,42	321
BE621705	7314150232680	1	6,42	321
BE621706	7314150232697	1	6,42	321
BE621707	7314150232703	1	6,42	321
BE621708	7314150232710	1	6,42	321
BE621709	7314150232727	1	6,42	321
BE621710	7314150232734	1	6,42	321
BE621711	7314150232741	1	6,42	321
BE621712	7314150232758	1	6,42	321
BE621713	7314150232765	1	6,42	321
BE621714	7314150232772	1	6,42	321
BE621715	7314150232789	1	6,42	321
BE621716	7314150232796	1	14,09	321
BE621717	7314150232802	1	14,09	321
BE630	7314150169580	3	185,81	320
BE63010015F	7314150232598	25	13,46	320
BE63010615F	7314150232604	1	13,46	320
BE63010815F	7314150232611	1	13,46	320
BE63010818F	7314150232628	1	13,46	320
BE630246F	7314150169597	50	26,00	320
BE6302712F	7314150412846	5	22,65	320
BE630276F	7314150169603	50	26,00	320
BE630326F	7314150169610	50	26,00	320
BE630366F	7314150169627	100	26,00	320
BE630386F	7314150169634	50	26,00	320
BE63064514F1	7314150340095	1	23,56	320
BE63064514F2	7314150340101	1	24,10	320
BE6306514F	7314150232123	12	13,46	320
BE630656714F	7314150232130	12	13,46	320
BE63066514F	7314150169641	25	26,00	320
BE630666F	7314150232116	1	13,46	320
BE6306814F	7314150232154	1	13,46	320
BE6307314F	7314150232161	1	13,46	320
BE6307414F	7314150370108	10	19,41	321
BE6307415F	7314150232178	1	13,46	320
BE630747615F	7314150232307	12	13,46	320
BE630757715F	7314150232321	1	13,46	320
BE6307612F	7314150232345	12	13,46	320
BE6307614F	7314150232369	12	13,46	320
BE6307630F	7314150232437	1	13,46	320
BE630768F	7314150232468	1	13,46	320
BE6307815F	7314150232475	12	13,46	320
BE6308015F	7314150232482	1	13,46	320
BE630808215F	7314150232499	1	13,46	320
BE6308616F	7314150232505	1	13,46	320
BE6308618F	7314150232512	1	13,46	320
BE6309015F	7314150232529	12	13,46	320
BE6309210F	7314150232536	1	13,46	320
BE6309315F	7314150232543	1	13,46	320
BE6309336F	7314150232550	1	13,46	320
BE6309345F	7314150232567	1	13,46	320
BE6309515F	7314150232574	1	13,46	320
BE6309618F	7314150232581	1	13,46	320
BE64350	7314150169672	1	53,18	319
BE64350CH	7314150169696	1	39,72	319
BE64520	7314150169665	1	63,29	319
BE64520CH	7314150169689	1	50,02	319
BE65F65120	7314150169658	12	14,82	319
BE65R106160	7314150170036	1	131,95	320
BE65R65120	7314150170012	1	29,62	320
BE65R80120	7314150170029	1	113,10	320
BE66152A	7314150492534	6	21,77	319
BE6701VAG	7314150333875	1	24,24	321
BE68	7314150237876	1	6,58	321
BE6810	7314150237869	1	13,33	321
BE6810Z	7314150430765	12	31,40	321
BE6FCP	7314150438907	30	44,41	315
BE6OF108	7314150434572	50	33,79	319
BE6OFW	7314150435784	5	60,95	319
BE700	7314150206087	1	85,56	312
BE700BP2	7314150206100	1	78,86	312
BE700SP15	7314150206094	1	37,19	312
BE74-55100	7314150169733	1	47,18	309
BE74-57125	7314150169511	1	48,58	309
BE74-57125L	7314150169535	1	52,89	309
BE74-80120	7314150169740	1	50,02	309
BE74-90175	7314150169528	1	72,86	309
BE76101	7314150240005	1	62,49	305



BE762	7314150384983	12	12,88	305
BE800P12	7314150205677	1	72,72	313
BELMS12OBDL	7314150340323	8	72,34	337
BELP1224	7314150177882	1	87,53	340
BELS12	7314150170579	1	92,91	340
BELT1213A	7314150493104	20	309,74	339
BELT127	7314150177899	1	106,37	339
BELT2415A	7314150493098	20	360,75	340
BELT247N	7314150170586	1	115,80	340
BELT247S	7314150170593	1	115,80	340
BELTKEY	7314150177875	1	177,73	339
BELTRP16	7314150169917	1	215,43	340
BELTRP1601	7314150231935	1	22,65	340
BELTRP1602	7314150231942	1	2,15	340
BELTRP1603	7314150231959	1	23,80	340
BELTRP1604	7314150231966	1	2,15	340
BELTRP1605	7314150231973	1	22,65	340
BELTRP1606	7314150231980	1	2,15	340
BELTRP1607	7314150231997	1	21,24	340
BELTRP1608	7314150232000	1	22,65	340
BELTRP1609	7314150232017	1	17,94	340
BELTRP1610	7314150232024	1	19,87	340
BELTRP1611	7314150232031	1	22,10	340
BELTRP1612	7314150232048	1	23,11	340
BELTRP1613	7314150232062	1	15,15	340
BELTRP1614	7314150232079	1	17,92	340
BELTRP1615	7314150232086	1	17,92	340
BELTRP1616	7314150232093	1	17,92	340
BFRL11	7314150306534	1	60,78	358
BG1S125	7314150416431	20	166,95	340
BH110000A-02	7314150273669	1	104,98	351
BH110000A-04	7314150273683	1	12,23	351
BH110000A-EXT	7314150291946	1	138,73	351
BH110000B	7314150516414	1	1.581,05	351
BH11500	7314150178797	1	579,46	350
BH11500-01	7314150182220	1	25,19	355
BH11500-02	7314150182237	1	17,73	351
BH11500-04	7314150182275	1	6,63	351
BH12000	7314150178803	1	515,08	350
BH13000	7314150178810	1	396,61	350
BH13000-02	7314150182244	1	22,57	351
BH13000L	7314150301980	1	1.249,05	351
BH13000L-01	7314150301997	1	16,90	355
BH13000QA	7314150403295	1	582,96	351
BH15000A-01	7314150273515	1	27,18	355
BH15000A-02	7314150273522	1	57,82	351
BH15000A-04	7314150273546	1	4,62	351
BH15000A-EXT	7314150291939	1	102,75	351
BH15000B	7314150516407	1	1.055,75	351
BH1A1500-04	7314150265299	1	33,57	355
BH1A1500A	7314150460946	1	368,79	350
BH1A1500A-05	7314150477302	40	10,28	351
BH1A2500-03	7314150226856	1	77,84	351
BH1A2500-04	7314150226863	1	59,32	355
BH1A2500A	7314150460953	1	565,08	350
BH1CB1000	7314150243204	1	179,01	351
BH1CD680	7314150330379	1	198,30	354
BH1CD680ST	7314150330386	1	97,34	354
BH1EU3000	7314150245000	1	254,95	350
BH1EU3000-01	7314150250004	1	13,64	351
BH1EU3000-03	7314150249893	1	6,81	351
BH1EU3000-08	7314150249947	1	24,14	355
BH1M1000	7314150237845	1	862,74	350
BH1S45	7314150292295	1	746,86	351
BH1S45-01	7314150311194	1	22,97	355
BH1S45-03	7314150311217	1	10,90	351
BH230	7314150264070	1	3.347,99	352
BH23015	7314150178759	1	2.685,25	352
BH23015C	7314150178742	1	1.673,99	352
BH2402010	7314150178766	1	2.304,96	352
BH2604020	7314150178773	1	3.154,83	353
BH28050	7314150472222	1	3.743,34	353
BH2AC1	7314150213474	1	55,96	353
BH2AC2	7314150213481	1	77,84	353
BH33000	7314150178674	1	64,89	353
BH36000	7314150178681	1	127,62	353
BH3A10000	7314150234660	1	289,34	353
BH3A3000	7314150234646	1	108,15	353
BH3A5000	7314150234653	1	162,23	353
BH3AL2500	7314150302420	1	151,95	353
BH3HD12000	7314150170500	1	219,11	353
BH3HD16000	7314150170524	1	262,90	354
BH3HD20000A	7314150337668	1	315,61	354
BH3HD8000	7314150170494	2	124,17	353
BH3SQ15000	7314150234684	2	247,61	353
BH3SQ7000	7314150234677	2	123,81	353
BH410	7314150178711	1	140,60	350
BH415	7314150178728	2	173,04	350
BH42	7314150178698	1	86,52	350
BH420	7314150178735	1	205,49	350
BH430	7314150178780	2	259,56	350
BH45	7314150178704	1	108,15	350
BH4HP50	7314150477081	1	713,79	350
BH4S12	7314150237920	3	84,36	349
BH4S2	7314150237883	6	34,61	349
BH4S20	7314150237937	1	129,78	349

			€	
BH4S4	7314150237890	6	54,08	349
BH4S50	7314150476879	1	281,19	349
BH4S6	7314150237906	4	64,89	349
BH4S8	7314150237913	4	77,87	349
BH5DP1000QA	7314150270224	1	925,85	354
BH5SP500QA	7314150270217	1	499,11	354
BH5US1000	7314150243174	1	236,42	354
BH6AC1-680A	7314150433544	1	116,80	355
BH6FC1000	7314150178650	1	832,76	355
BH6FC2000	7314150234639	1	1.339,19	355
BH6PC600	7314150234622	1	1.004,39	355
BH7100A	7314150345908	1	7.713,24	341
BH7100SG	7314150299782	1	450,68	342
BH715	7314150237555	1	1.027,43	341
BH715-13	7314150239191	1	148,10	341
BH720	7314150235650	1	1.885,18	341
BH720-22	7314150236961	1	161,54	341
BH720SG	7314150238477	1	150,31	342
BH730	7314150235667	1	2.207,09	341
BH730SG	7314150238484	1	163,99	342
BH750	7314150235674	1	3.242,38	341
BH750SG	7314150238491	1	177,65	342
BH7PS30	7314150474882	2	313,64	341
BH8AC1-500	7314150170463	1	160,11	313
BH8AC2-500	7314150412532	1	472,24	313
BH8AC3-1500A	7314150516391	1	1.879,75	354
BH8AC3-600	7314150351893	1	973,35	354
BH8BC1	7314150242276	1	115,10	349
BH8BC2	7314150242283	1	137,56	349
BH8BC3	7314150242290	10	108,76	349
BH8BC4	7314150242306	6	233,82	349
BH8BC5	7314150242313	6	161,52	349
BH8PR10000	7314150178957	1	397,21	349
BH8PR4000	7314150178940	1	264,91	349
BH9BJ22SLH	7314150246946	1	753,25	352
BH9BJ22SSH	7314150247462	1	733,97	352
BH9BJ23SLH	7314150246953	1	1.011,51	352
BH9BJ23SSH	7314150246960	1	992,20	352
BH9BJ260	7314150247509	1	35,84	352
BH9BJ280	7314150247516	1	41,57	352
BHVG15-250	7314150403745	1	9,88	355
BHVIS06100	7314150167753	1	504,93	332
BHVIS06105	7314150167760	1	572,24	332
BHVIS0670	7314150167692	1	97,62	332
BHVIS0677	7314150167708	1	129,26	332
BHVIS0680	7314150167715	1	137,34	332
BHVIS0685	7314150167722	1	201,97	332
BHVIS0690	7314150167739	1	214,08	332
BHVIS0695	7314150167746	1	336,61	332
BHVIS08100	7314150165711	1	193,21	332
BHVIS08115	7314150165728	1	197,53	332
BHVIS0895	7314150165704	1	175,04	332
BHVIS109BPW12	7314150165759	1	206,96	332
BHVIS111BPW12	7314150165735	1	216,79	332
BHVIS120BPW16	7314150165742	1	240,34	332
BHVIS1265	7314150167685	1	86,16	332
BHVIS80BPW12	7314150165766	1	153,49	332
BHVIS95BPW9	7314150243334	1	158,88	332
BKE850901N	7314150449705	10	14,99	229
BLBT100	7314150179015	1	1.205,08	343
BLBT100AC1	7314150179022	1	312,45	343
BLCR230FR	7314150247356	1	254,92	358
BLCR230SC	7314150247349	1	254,92	358
BLCR24VCL	7314150247370	1	436,99	358
BLCR24VLL	7314150247387	1	589,58	358
BLCR400E	7314150247363	1	902,97	358
BLCRSC1	7314150247530	1	94,79	358
BLCRSC2	7314150247547	1	94,79	358
BLE300	7314150227648	1	187,16	343
BLE301	7314150227662	1	117,15	343
BLE302	7314150227679	1	123,65	343
BLE304	7314150249572	1	166,96	343
BLE305	7314150339341	1	152,56	342
BLEMAT1	7314150477678	1	435,38	342
BLEMAT1BT	7314150477685	1	86,39	342
BLT550	7314150243556	10	75,40	304
BLTFC1	7314150246434	20	95,01	358
BLTS10	7314150246427	20	62,00	358
BLTS7P	7314150246410	58	56,38	358
BMD150	7314150242238	1	12,78	342
BMMTRMS1	7314150274024	1	214,26	339
BMR240	7314150242245	1	22,90	342
BMVAT1000	7314150488360	50	135,91	339
BOD101	7314150205967	1	51,66	321
BOD1016	7314150169979	1	39,06	323
BOD101NWS	7314150269099	1	38,51	321
BOD101T	7314150269150	1	18,43	324
BOD102	7314150205974	1	54,63	321
BOD102NWS	7314150269105	1	42,90	321
BOD102T	7314150269167	1	22,96	324
BOD103	7314150205981	1	54,63	321
BOD103NWS	7314150269112	1	38,51	321
BOD103T	7314150269174	1	18,43	324
BOD104	7314150205998	1	59,05	321
BOD104NWS	7314150269129	1	42,43	321
BOD104T	7314150269181	1	23,71	324

			€	
BOD105	7314150206001	1	62,00	321
BOD105NWS	7314150269136	1	42,43	321
BOD105T	7314150269198	1	26,12	324
BOD106	7314150206018	1	67,18	321
BOD106NWS	7314150269143	1	56,83	321
BOD106T	7314150269204	1	22,33	324
BOD10P64	7314150205950	8	133,31	321
BOD2008	7314150169986	1	45,10	323
BOD2FS	7314150351879	20	15,40	324
BOD301200	7314150169993	1	28,28	323
BOD4200	7314150169436	1	9,83	323
BOD4500	7314150169443	1	11,98	323
BOD54-1	7314150239467	1	11,37	324
BOD54-2	7314150239474	1	13,57	324
BOD54-3	7314150239481	1	9,14	324
BOD5400	7314150169450	1	35,72	324
BOD5450	7314150169474	1	59,35	324
BOD5HD400	7314150169467	1	55,15	324
BOD60	7314150169481	1	52,52	324
BOD6080P12	7314150235407	1	437,61	322
BOD6080P12-01	7314150235438	1	20,33	322
BOD6080P12-02	7314150235445	1	26,14	322
BOD6080P12-03	7314150235452	1	26,14	322
BOD6080P12-04	7314150235469	1	26,14	322
BOD6080P12-05	7314150235476	1	20,33	323
BOD6080P12-06	7314150235490	1	24,17	323
BOD6080P12-07	7314150235506	1	21,16	323
BOD6080P12-08	7314150235513	1	24,17	323
BOD6080P12-09	7314150235520	1	20,33	323
BOD6080P12-10	7314150235537	1	28,12	323
BOD6080P12-11	7314150235544	1	24,17	323
BOD70	7314150169498	1	152,51	324
BOD8901	7314150169016	1	552,04	322
BOD8901AC1	7314150178490	1	89,04	322
BOD8902	7314150169023	1	713,62	322
BOD8903A	7314150265374	1	801,14	322
BOM10X	7314150540549	10	38,11	361
BP-40	7314150453085	1	49,13	573
BP-40-95	7314150487097	12	3,85	573
BP110	7314150135011	1	221,76	279
BP111E	7314150235872	12	309,35	279
BP115	7314150134991	1	202,66	277
BP117	7314150184309	1	262,71	277
BP117EH	7314150184316	1	45,25	279
BP118	7314150235834	1	239,07	277
BP125A	7314150427291	6	697,92	285
BP127	7314150137565	1	394,04	279
BP12718	8414909179002	1	22,53	280
BP127P	7314150427277	1	271,38	279
BP204	7314150184286	1	270,19	281
BP20410320	7314150185948	1	17,25	281
BP20410800	7314150185955	1	9,15	281
BP20425180	7314150185924	1	34,50	281
BP20425220	7314150185931	1	34,50	281
BP204K	7314150184293	1	487,88	281
BP204PAD	7314150185917	1	15,10	281
BP212	7314150134601	1	244,31	281
BP215A	7314150341849	10	65,80	285
BP218	7314150170272	1	25,23	286
BP219	7314150235889	1	21,72	286
BP219L	7314150235896	1	25,25	286
BP219V	7314150307197	1	71,90	286
BP219XL	7314150427192	10	22,55	286
BP222	7314150137572	1	255,20	281
BP233	7314150134748	1	362,53	283
BP254	7314150137633	1	142,56	286
BP255	7314150137640	1	213,83	287
BP255T	7314150427307	1	267,61	287
BP255T-1	7314150427314	1	42,72	287
BP277K	7314150427284	8	277,66	285
BP420M	7314150134618	1	4,56	278
BP421M	7314150134625	1	4,56	278
BP422M	7314150134632	1	4,56	278
BP423M	7314150134649	1	4,56	278
BP424M	7314150134656	1	4,56	278
BP430M	7314150134663	1	4,56	278
BP431M	7314150134670	1	4,56	278
BP432M	7314150134687	1	4,56	279
BP433M	7314150134694	1	4,56	279
BP434M	7314150135837	1	4,56	279
BP500	7314150137992	1	55,44	286
BP51137	7314150134724	1	40,70	281
BP601	7314150134526	1	394,04	281
BP60102	7314150426669	1	55,98	281
BP610	7314150134595	1	394,04	282
BP700	7314150134458	20	204,10	277
BP704	7314150427130	1	212,33	274
BP721	7314150427185	1	182,18	277
BP799	7314150134502	1	202,53	285
BP79912	7314150134717	1	42,74	285
BP809	7314150235841	1	406,48	282
BP80950	7314150275564	1	12,43	282
BP810	7314150235858	1	353,76	282
BP811	7314150235865	1	136,99	284
BP814	7314150184262	10	254,92	274
BP814A	7314150304349	10	496,77	274





BP815	7314150134311	1	254,92	274
BP815K1	7314150181957	1	372,58	274
BP815K2	7314150181964	1	320,29	274
BP817	7314150134106	1	620,95	275
BP820	7314150134465	1	217,66	277
BP821	7314150134472	1	255,28	277
BP822	7314150134984	1	165,49	278
BP822E	7314150184279	10	202,66	278
BP823	7314150135004	1	420,31	279
BP824	7314150134489	1	336,69	283
BP825	7314150134496	1	359,70	282
BP826	7314150137459	1	364,77	283
BP827	7314150137442	1	405,09	283
BP828	7314150427260	1	276,40	283
BP830CISB	7314150439799	1	36,70	280
BP830ESB	7314150439751	1	27,24	280
BP830EWB	7314150439768	1	27,24	280
BP830K	7314150427208	4	521,40	280
BP830MISB	7314150439782	1	36,70	280
BP830SBA	7314150439805	1	23,87	280
BP830SSB	7314150439775	1	36,70	280
BP830SW	7314150439744	1	27,24	280
BP901	7314150336012	1	986,99	276
BP901L	7314150336029	1	1.000,05	276
BP905L	7314150336234	2	1.305,95	276
BP905P	7314150336210	2	1.300,73	276
BP905S	7314150336227	2	1.292,89	276
BP909NE	7314150187980	1	97,68	285
BP909NF	7314150187973	1	79,64	285
BP909TE	7314150187942	1	37,56	284
BP909TF	7314150187911	1	29,31	284
BP909TH	7314150187959	1	37,56	284
BP909TSP	7314150187966	1	29,31	285
BP909TTP	7314150187935	1	29,31	284
BP909TWF	7314150187928	1	29,31	284
BP910	7314150427246	5	182,18	284
BP91BL	7314150192779	1	3,02	277
BP91BS	7314150192786	1	3,02	277
BPA823	7314150427161	1	154,54	282
BPGG3515	7314150134823	1	34,68	283
BPGG3525A	7314150134830	1	34,68	283
BPGG3525B	7314150134847	1	38,63	283
BPGG5725	7314150134861	1	34,68	284
BPGG9057	7314150134878	1	84,32	284
BPBK30	7314150134854	1	34,68	283
BPBL00900	7314150358335	5	64,39	344
BPBL30900	7314150360451	5	64,39	344
BPBL70600	7314150360468	5	56,62	344
BPBL90600	7314150358366	5	57,59	344
BPBL54	7314150360475	2	237,49	344
BPBSC156	7314150134816	1	51,04	283
BPBU18	7314150134755	1	56,74	284
BPBU24	7314150134762	1	56,74	284
BPBU36	7314150134779	1	64,63	284
BPBU60	7314150134786	1	69,36	284
BPBU90	7314150134793	1	84,32	284
BPC813	7314150296408	10	254,92	274
BPC813K1	7314150331253	1	344,15	274
BPC814	7314150296392	10	294,15	275
BPC815	7314150296385	1	307,21	275
BPC815K1	7314150331208	1	592,19	275
BPC815K2	7314150331215	1	507,40	275
BPC815K3	7314150331222	1	523,78	275
BPC815K4	7314150331239	1	548,31	275
BPC815K6	7314150331284	1	483,01	275
BPC816	7314150296415	10	301,40	274
BPC817	7314150296422	4	699,40	275
BPC817K1	7314150331260	1	1.037,16	276
BPC817K2	7314150331277	1	1.019,36	276
BPC823	7314150427147	1	157,04	282
BPC825	7314150427154	1	183,43	282
BPCVB1	7314150384792	6	226,49	334
BPG824	7314150427253	10	314,10	283
BPH1010A	7314150330010	1	47,27	287
BPH1010B	7314150341757	1	38,37	287
BPH1310A	7314150330003	1	85,63	287
BPHRC1015	7314150247400	1	287,59	287
BPHRC1020	7314150247417	1	390,88	287
BPHRC1316	7314150247455	1	424,87	287
BPHRC815	7314150247394	1	260,14	287
BPHRO1315	7314150247431	1	575,20	288
BPHRSC	7314150247448	1	94,79	287
BPHVLP01	7314150138937	1	194,78	285
BPHVLP0112	7314150165872	1	22,86	286
BPHVLP0114	7314150165889	1	22,86	286
BPHVLP0117	7314150165896	1	22,86	286
BPHVLP0120	7314150165902	1	22,86	286
BPM917BOOT	7314150281664	1	15,32	276
BPM91MK1	7314150186938	1	5,81	276
BPM91MK2	7314150186945	1	5,81	276
BPN010	7314150219728	1	201,92	286
BPN21201	7314150134731	1	141,86	282
BPN22201	7314150138074	1	167,09	282
BPN251	7314150137589	1	16,08	287
BPOC15	7314150360673	12	79,47	314
BPR821	7314150427178	1	263,84	277



BPSJ	7314150427239	1	30,15	288
BPSJL	7314150439812	1	35,18	288
BS1000	7314150170081	1	390,48	336
BS100001	7314150232819	1	17,76	336
BS100002	7314150232826	1	17,76	336
BS100003	7314150232833	1	17,76	336
BS100004	7314150232840	1	17,76	336
BS100005	7314150232857	1	17,76	336
BS100006	7314150232864	1	17,76	336
BS100007	7314150232871	1	17,76	336
BS100008	7314150232888	1	17,76	336
BS100009	7314150232895	1	17,76	336
BS100010	7314150232901	1	14,52	336
BS100011	7314150232918	1	14,52	336
BS100012	7314150232925	1	14,52	336
BS100013	7314150232932	1	12,09	336
BS100014	7314150232949	1	12,09	336
BS100015	7314150232956	1	12,09	336
BS100016	7314150232963	1	12,09	336
BS100017	7314150232970	1	12,09	336
BS100018	7314150232987	1	12,09	336
BS100019	7314150232994	1	12,09	336
BS100020	7314150233007	1	12,09	336
BS100021	7314150233014	1	12,09	336
BS100022	7314150233021	1	14,52	336
BS100023	7314150233038	1	14,52	336
BS100024	7314150233045	1	14,52	336
BS100025	7314150233052	1	14,52	336
BS100026	7314150233069	1	14,52	336
BS100027	7314150233076	1	14,52	337
BS100028	7314150233083	1	14,52	337
BS100029	7314150233090	1	12,09	337
BS100030	7314150233106	1	12,09	337
BS100031	7314150233113	1	12,09	337
BS100032	7314150233120	1	12,09	337
BS100033	7314150233137	1	12,09	337
BS100034	7314150233144	1	12,09	337
BS100035	7314150233151	1	16,23	337
BS100036	7314150233168	1	16,23	337
BS100037	7314150233175	1	16,23	337
BS100038	7314150233182	1	16,23	337
BS100039	7314150233199	1	16,23	337
BS100PSA1	7314150249282	1	101,56	335
BS10AC2	7314150182343	1	592,45	336
BS15	7314150206117	1	666,50	336
BS15125	7314150231775	1	77,34	336
BS15125C	7314150231812	1	6,87	336
BS15160	7314150231782	1	82,72	336
BS15160C	7314150231829	1	6,87	336
BS15212	7314150231799	1	88,15	336
BS15212C	7314150231836	1	6,87	336
BS1550	7314150231805	1	44,66	336
BS25	7314150416103	1	227,77	336
BS30AC1	7314150383504	1	479,34	336
BS30PG	7314150436644	1	2.474,20	336
BS40VAG	7314150430642	20	63,95	334
BS45BMW	7314150430659	20	35,53	334
BS52	7314150329212	1	249,09	334
BS5228341	7314150329229	1	88,86	333
BS5234401	7314150329236	1	88,86	333
BS5239451	7314150329243	1	88,86	333
BS54	7314150243341	1	64,63	334
BS56	7314150430826	6	35,25	334
BS618	7314150242368	1	53,87	335
BS623	7314150242375	1	105,28	335
BSSHE3	7314150251858	1	101,46	333
BT10P3	7314150205639	1	123,86	344
BT10P325	7314150231706	40	40,92	344
BT10P330	7314150231713	1	44,71	344
BT10P338	7314150231720	1	51,00	344
BT15P5	7314150205837	1	81,19	332
BT15P524	7314150231737	1	12,61	332
BT15P530	7314150231744	1	15,16	332
BT15P532	7314150231751	1	16,32	332
BT15P536	7314150342129	1	21,76	332
BT20P26	7314150205820	1	693,43	335
BT20P49	7314150385041	1	2.523,68	335
BTL-3-13	7314150333349	12	7,25	538
BTL-6-13	7314150333356	12	9,26	538
BTR-3-13	7314150333332	12	7,25	538
BTR-6-13	7314150333363	12	9,26	538
BUC100	7314150169962	1	100,99	319
BUC110	7314150206025	1	46,46	319
BUC50	7314150182329	1	64,63	318
BUCKET - 1446-CS	7314150534555	1	646,84	585
BUCKET - EMPTY	7314150511037	6	16,48	585
BUCKET 1446	7314150436446	75	8,36	585
BUCKET-1446-FLOAT	7314150539550	1	796,14	585
BUCPE	7314150243259	1	754,01	318
BUCPE3SDH	7314153024183	1	203,66	318
BUCPE3SH	7314150243471	1	200,03	318
BUCPEF	7314150244942	1	77,90	318
BUCPEF1	7314150245116	1	6,74	318
BWB14	7314150170166	2	484,49	334
BWB1418S4	7314150365593	6	72,97	342
BWB1922S4	7314150365609	6	82,25	342



BWBB	7314150407828	200	8,41	330
BWC1	7314150365586	25	17,25	331
BWHEHS	7314150251841	1	245,76	333
BWHEP	7314150251834	1	235,77	333
BWHEPS	7314150264087	1	457,51	332
BWHEPSH8	7314150264889	1	598,30	333
BWHEPSSH8	7314150264896	1	968,25	332
BWHPJ12	7314150403257	4	304,14	335
BWHTRS12	7314150384808	15	220,01	330
BWMSP15	7314150239740	1	103,46	369
BWMSP1501	7314150239757	1	5,12	369
BWMSP1502	7314150239764	1	5,12	369
BWMSP1503	7314150239771	1	5,12	369
BWMSP1504	7314150239788	1	5,12	369
BWMSP1505	7314150239795	1	5,12	369
BWMSP1506	7314150239801	1	5,12	369
BWMSP1507	731415024176	1	5,12	369
BWMSP1508	7314150239818	1	5,12	369
BWMSP1509	7314150239825	1	5,12	369
BWMSP1510	7314150239832	1	5,12	369
BWMSP1511	7314150239849	1	5,12	369
BWMSP1512	7314150239856	1	5,58	369
BWMSP1513	7314150239863	1	5,58	369
BWMSP1514	7314150239870	1	5,58	369
BWMSP1515	7314150239887	1	5,58	369
BWP150	7314150170159	1	24,24	331
BWSH5	7314150251810	2	342,91	333
BWSH51	7314150251827	1	18,31	333
BWSH8	7314150255191	1	444,37	333
BWSHK21	7314150403271	25	16,83	329
BWSMB15	7314150365074	25	14,46	328
BWSMB17	7314150329656	1	16,15	329
BWSS12P3	7314150170128	20	40,26	328
BWSS12P317	7314150203451	1	13,33	328
BWSS12P317L	7314150330065	1	23,97	329
BWSS12P319	7314150203468	1	14,15	328
BWSS12P319L	7314150330072	1	24,10	329
BWSS12P321	7314150203475	1	14,15	328
BWSS12P321L	7314150330089	1	24,24	329
BWSS12P3L	7314150330096	1	97,06	329
BWSS12P5	7314150170135	1	61,94	328
BWSS12P522	7314150203482	1	16,15	328
BWSS12P524	7314150203499	1	16,15	328
BWTB12P100	7314150329830	1	23,56	330
BWTB12P110	7314150329847	1	23,56	330
BWTB12P120	7314150329854	1	23,56	330
BWTB12P135	7314150329861	1	23,56	330
BWTB12P150	7314150329878	1	23,56	330
BWTB12P160	7314150329885	1	23,56	330
BWTB12P175	7314150329892	1	23,56	330
BWTB12P190	7314150329908	1	23,56	330
BWTB12P200	7314150329915	1	23,56	330
BWTB12P5	7314150329991	1	119,84	330
BWTB12P90	7314150329823	1	23,56	330
BWTDG1	7314150403400	50	38,18	331
BWTGP1	7314150351886	10	53,32	331
BWTPMSS4C	7314150347100	25	34,34	332
BWTPMSS9	7314150347124	8	321,80	331
BWTSP16	7314150170296	1	291,59	330
BWTSP1608	7314150203284	1	24,20	330
BWTSP1610	7314150203291	1	15,27	330
BWTSP1611	7314150203307	1	15,27	330
BWTSP1612	7314150203314	1	15,27	330
BWTSP1613	7314150203321	1	15,27	330
BWTSP1614	7314150203338	1	15,27	330
BWTSP1616	7314150203345	1	16,36	330
BWTSP1617	7314150203352	1	16,36	330
BWTSP1618	7314150203369	1	16,36	330
BWTSP1619	7314150203376	1	16,36	330
BWTSP1621	7314150203383	1	31,90	330
BWTSP1622	7314150203390	1	32,24	330
BWTSP1624	7314150203406	1	32,99	330
BWTSP1627	7314150203413	1	33,62	330
BWTSP317L	7314150335480	1	40,33	329
BWTSP319L	7314150335497	1	43,76	329
BWTSP321L	7314150335503	1	47,46	329
BWTSP3L	7314150335473	1	132,62	329
BWTSP6	7314150240043	1	94,54	329
BWTSP617	7314150242399	1	18,93	329
BWTSP619	7314150242405	1	18,93	329
BWTSP621	7314150242412	1	18,93	329
BWTSP622	7314150242429	1	19,65	329
BWTSP624	7314150242436	1	19,65	329
BWTSP7	7314150170302	1	266,34	329
BWTSP732	7314150203420	1	78,12	330
BWTSP736	7314150203437	1	92,72	330
BWTSP741	7314150203444	1	107,99	330
BWTVCTT355	7314150347179	1	28,13	332
BWXW1	7314150167661	1	35,01	328
BWXW2	7314150167678	4	105,02	328
BWXW3	7314150214624	1	32,32	328
BWXW4	7314150214631	1	109,08	328
BZWBT0132450	7314150165674	1	176,49	330
BZWBT0132600	7314150165681	1	176,49	330
C0312I03	7314150501298	5	13,50	147
C0313M03	7311518100636	1	14,52	144



C0313M03X	7311518182045	1	15,12	144
C0616AL06	7311518181826	1	33,46	145
C0616M03X	7311518204679	1	30,84	144
C0616M06	7311518100667	1	27,83	144
C0616M06X	7311518100681	1	29,23	144
C0618I06	7314150501311	5	23,94	147
C0618S06	7314150501342	5	21,97	146
C0820M06	7311518100711	1	39,92	144
C0820M06X	7311518100735	1	41,93	144
C1020I06	7314150501373	5	32,23	147
C1020M06	7311518100766	1	40,73	144
C1020M06X	7311518100780	1	42,74	144
C1020S06	7314150501403	5	29,56	146
C1225AL06	7311518187637	1	63,92	145
C1225I06	7314150506743	5	61,23	147
C1225M06	7311518100810	1	60,49	144
C1225M06X	7311518100834	1	67,43	144
C1225M08X	7311518187996	1	63,92	144
C1225S06	7314150501465	5	46,46	146
C1625M06	7311518192266	1	74,00	144
C1625M06X	7311518187378	1	77,63	144
C1625M08	7311518100902	1	74,00	144
C1625M08X	7311518100926	1	77,63	144
C1997LM/9P	7314150510375	1	36,77	225
C1997TORX/9P	7314150510382	1	36,77	226
C3140	7314150393312	10	36,36	234
C3140IP	7314150391158	10	35,95	234
C3230	7314150393329	10	49,18	237
C3230IP	7314150391189	10	48,70	237
C3330	7314150393336	10	35,29	234
C3330IP	7314150391196	10	34,88	234
C3330R	7314150393343	10	35,29	234
C3330R IP	7314150391202	10	34,88	234
C3340R	7314150393350	10	36,19	234
C3340R IP	7314150391219	10	36,24	234
C3430	7314150393367	10	36,60	246
C3430IP	7314150391226	10	36,19	245
C3530	7314150393374	10	36,95	246
C3530IP	7314150391233	10	36,19	246
C3630	7314150393381	10	41,13	242
C3630IP	7314150391240	10	40,30	242
C3640	7314150393398	10	42,33	242
C3640IP	7314150391257	10	41,37	242
C3745	7314150393404	10	39,16	243
C3745IP	7314150391264	10	38,51	243
C3790	7314150393411	10	39,52	243
C3790IP	7314150391271	10	38,51	243
C3830	7314150393428	10	36,95	242
C3830IP	7314150391288	10	36,22	242
C3840	7314150393435	10	36,95	242
C3840IP	7314150391295	10	36,24	242
C3901/3	7314150392797	1	123,40	257
C3902/3	7314150399604	1	113,00	258
C3903/2-6	7314150466481	1	113,62	258
CFP250	7314150400669	6	23,78	612
CHALK-BLUE	7314150128686	6	3,09	542
CHALK-RED	7314150128709	6	3,09	542
CHALK-WHITE	7314150179671	6	3,28	542
CHALK-YELLOW	7314150128693	6	3,09	542
CL-1221	7314150127122	6	12,17	542
CL-1221-SET	7314150188574	4	17,68	542
CL-1331	7314150347728	48	18,76	542
CL-1441	7314150347735	36	24,27	542
CLIPS-1/2	7314153003201	25	0,37	95
CLIPS-1/4	7314153003188	25	0,37	82
CLIPS-3/8	7314153003195	25	0,37	88
CR B 01	7314150215409	60	27,62	254
CR B 02	7314150215416	60	26,57	254
CR B 03	7314150215423	60	27,04	254
CR B 05	7314150215454	2	53,76	255
CR B 06	7314150215461	2	107,50	255
CR L 01	7314150215911	1	398,68	257
CR L 02	7314150215928	1	294,47	257
CR L 03	7314150215935	1	448,52	257
CR OV 01	7314150489978	1	157,47	256
CR SA H01	7314150489992	1	219,33	255
CR SA H16	7314150508990	1	240,45	256
CR SA S01	7314150490011	1	212,58	256
CR SA T01	7314150490035	1	208,08	256
CR W 01	7314150215492	1	155,55	255
CR W 02	7314150215508	1	129,86	255
CR W 03	7314150215515	1	129,86	255
CR W 04	7314150215522	1	135,78	256
CR W 05	7314150215539	1	137,88	256
CR W 06	7314150215546	1	145,73	256
CS-SPARE	7314150453030	1	4,44	544
CS150	7314150125241	12	12,75	544
CS300	7314150125258	12	23,72	544
CS400	7314150125265	12	26,40	544
D-DD/S20	7311518280345	4	94,75	178
D/S10	7311518280307	6	61,26	179
D/S14	7311518280314	6	83,71	179
D0303I03	7314150501281	5	13,50	147
D0303M03	7311518100957	1	18,46	144
D0303M03X	7311518182052	1	19,32	144
D0605M03X	7311518197896	1	29,71	144





D0606106	7314150501328	5	22,01	147
D0606M06	7311518100988	1	28,23	144
D0606M06X	7311518101008	1	29,71	144
D0606S06	7314150501359	5	20,17	146
D0807M06	7311518043896	1	29,08	144
D0807M06X	7311518043919	1	30,56	144
D1009M06	7311518035280	1	30,14	144
D1009M06X	7311518035297	1	31,61	144
D1010I06	7314150501380	5	26,46	147
D1010S06	7314150501410	5	24,24	146
D1211AL06	7311518187644	1	50,52	146
D1211AL08	7311518181840	1	50,52	146
D1211M06	7311518035334	1	42,02	144
D1211M06X	7311518035358	1	44,15	144
D1212I06	7314150501441	5	35,69	147
D1212S06	7314150501472	5	32,70	146
D1614M06	7311518192327	1	62,24	144
D1614M06X	7311518187385	1	61,97	144
D1614M08	7311518035389	1	59,00	144
D1614M08X	7311518035402	1	61,99	144
DD/S10	7311518280321	6	60,33	179
DD/S14	7311518280338	4	96,77	178
DOW 175-1	7314152202728	1	39,56	266
DOW 175-11/2	7314152202995	1	54,29	266
DOW 175-2	7314152203022	1	85,12	266
DOW 175-3	7314152203299	1	141,82	266
DOW 176-1	7314152206047	1	51,47	267
DOW 176-11/2	7314152206122	1	66,16	267
DOW 176-2	7314152206399	1	91,07	267
DOW 177-1/2-1	7314152816383	1	49,10	266
DOW 177-11/2	7314152816468	1	62,39	266
DOW 177-2	7314152816543	1	93,22	266
E0308M03	7311518035433	1	23,77	144
E0308M03X	7311518192372	1	25,05	144
E0614M06	7311518035464	1	40,74	144
E0816M06	7311518035518	1	46,16	144
E0816M06X	7311518035532	1	45,97	144
E1015I06	7314150501496	5	32,23	147
E1018M06	7311518035563	1	48,79	144
E1018M06X	7311518035587	1	51,21	144
E1220I06	7314150501526	5	47,21	147
E1222M06	7311518035617	1	56,05	144
E1222M06X	7311518035631	1	58,88	144
E1222M08	7311518172558	1	59,01	144
E1222M08X	7311518199302	1	61,99	144
E1625M06	7311518192440	1	90,33	144
E1625M06X	7311518187392	1	99,35	144
E1625M08	7311518035709	1	90,33	144
E1625M08X	7311518035723	1	94,76	144
EX-14-TEN-C	7311518298333	5	36,62	563
EX-14-VEN-C	7311518298340	10	30,83	563
EX-16-GNP-C	7311518298685	10	32,11	560
EX-19-XT9-C	7311518298302	10	42,70	562
EX-20-LAM-C	7311518298326	10	45,13	563
EX-20-XT11-C	7311518298319	10	44,19	563
EX-22-PLS-C	7311518298357	10	40,34	560
EX-22-U7	7311518300890	10	15,49	562
EX-22-XT7-C	7311518298289	10	44,19	564
EX-22-XT9-C	7311518298296	10	44,19	562
EX-24-XT7-C	7311518298272	10	45,75	564
EX-24P-22	7311518298456	10	23,09	564
EX-LL	7311518298494	4	39,56	566
EX-NPP-22	7311518324162	10	18,90	562
EX-RL	7311518298487	4	39,56	566
EX-RM	7311518298470	4	39,56	566
F0312I03	7314150501502	5	13,50	147
F0313M03	7311518035754	1	14,52	144
F0313M03X	7311518192495	1	15,32	144
F0613M03X	7311518196608	1	31,92	144
F0618AL06	7311518181857	1	42,74	146
F0618I06	7314150501533	5	25,00	147
F0618M06	7311518035792	1	35,69	144
F0618M06X	7311518035815	1	37,51	144
F0618S06	7314150501564	5	22,93	146
F0820M06	7311518035839	1	46,97	144
F0820M06X	7311518035860	1	49,40	144
F1020I06	7314150501595	5	31,55	147
F1020M06	7311518035891	1	45,77	144
F1020M06X	7311518035914	1	47,99	144
F1020S06	7314150501625	5	28,91	146
F1225AL06	7311518187651	1	58,07	146
F1225AL08	7311518181864	1	58,07	146
F1225I06	7314150501656	5	46,66	147
F1225M06	7311518035945	1	58,07	144
F1225M06X	7311518036003	1	60,89	144
F1225M08	7311518035983	1	58,07	144
F1225M08X	7311518192563	1	60,89	144
F1225S06	7314150501687	5	42,76	146
F1625M06	7311518192570	1	88,91	144
F1625M06X	7311518187408	1	88,51	144
F1625M08	7311518036034	1	88,73	144
FCP-1.8-810	7311518123970	4	81,88	600
FCP-2.3-860	7311518123994	2	91,09	600
FCS-1000	7314150321551	6	25,22	545
FCS-600	7314150321537	6	21,69	545
FCS-800	7314150321544	6	23,04	545



FF1A01	7314150228560	1	699,63	395
FF1A02	7314150228591	1	257,26	395
FF1A03	7314150228607	1	208,29	395
FF1A04	7314150227778	1	469,15	395
FF1A051	7314150478446	1	718,11	395
FF1A06	7314150227822	1	414,56	396
FF1A07	7314150227846	1	249,17	396
FF1A08	7314150227976	1	1.652,00	396
FF1A09	7314150227990	1	524,87	396
FF1A1004	7314150286454	1	144,62	396
FF1A1010	7314150320660	1	237,08	397
FF1A1011	7314150339068	1	112,46	397
FF1A102	7314150334841	1	351,75	397
FF1A104	7314150334865	1	201,53	397
FF1A106	7314150335541	1	326,96	397
FF1A11	7314150228034	1	692,99	397
FF1A110	7314150335619	1	259,69	398
FF1A112	7314150335572	1	285,65	398
FF1A114	7314150335633	1	344,67	398
FF1A115	7314150335640	1	232,41	398
FF1A117	7314150335701	1	227,81	398
FF1A118	7314150335732	1	319,88	398
FF1A119	7314150335749	1	297,46	399
FF1A12	7314150228058	1	393,57	399
FF1A121	7314150335718	1	336,41	399
FF1A124	7314150335725	1	201,53	399
FF1A127	7314150336395	1	248,94	399
FF1A128	7314150336586	1	449,73	399
FF1A129	7314150336593	1	352,93	400
FF1A13	7314150228072	1	1.572,64	400
FF1A130	7314150336661	1	711,25	400
FF1A131	7314150336678	1	260,79	400
FF1A132	7314150336685	1	385,27	400
FF1A133	7314150336692	1	154,10	401
FF1A134	7314150336708	1	213,38	401
FF1A135	7314150336715	1	651,98	401
FF1A136	7314150336722	1	438,61	401
FF1A137	7314150336739	1	651,98	401
FF1A138	7314150336746	1	254,87	402
FF1A139	7314150336753	1	189,67	402
FF1A14	7314150228089	1	695,60	402
FF1A141	7314150336777	1	734,96	402
FF1A142	7314150338573	1	628,26	402
FF1A143	7314150338580	1	254,87	402
FF1A145	7314150338603	1	302,28	403
FF1A146	7314150338610	1	616,41	403
FF1A147	7314150338627	1	260,79	403
FF1A15	7314150228096	1	768,30	403
FF1A153	7314150350445	1	354,11	403
FF1A154	7314150350476	1	183,32	404
FF1A16	7314150228102	1	560,41	404
FF1A164	7314150350957	1	565,86	404
FF1A165	7314150350964	1	320,82	404
FF1A167	7314150350988	1	330,50	404
FF1A168	7314150350995	1	219,99	404
FF1A169	7314150351008	1	271,48	405
FF1A170	7314150351800	1	286,44	405
FF1A18	7314150228126	1	324,00	405
FF1A185	7314150358694	1	180,25	405
FF1A189	7314150405961	1	234,88	405
FF1A19	7314150254354	1	453,17	405
FF1A194	7314150431496	1	676,01	406
FF1A195LM	7314150455850	1	401,02	389
FF1A196LM	7314150455874	1	504,14	390
FF1A197LM	7314150455881	1	423,94	390
FF1A198LM	7314150455898	1	286,44	390
FF1A199LM	7314150455904	1	607,26	390
FF1A20	7314150254361	1	509,67	406
FF1A200LM	7314150455928	1	492,68	390
FF1A201LM	7314150455935	1	263,53	391
FF1A202LM	7314150455966	1	171,87	390
FF1A203LM	7314150455973	1	160,41	391
FF1A204LM	7314150455980	1	263,53	391
FF1A205LM	7314150455997	1	263,53	391
FF1A206LM	7314150456000	1	366,65	391
FF1A207LM	7314150456017	1	446,85	391
FF1A208LM	7314150456024	1	389,56	392
FF1A209LM	7314150456031	1	320,82	392
FF1A210LM	7314150456062	1	435,39	392
FF1A211LM	7314150456079	1	194,78	392
FF1A212LM	7314150456086	1	217,70	392
FF1A213	7314150437283	1	985,36	392
FF1A214LM	7314150456093	1	343,73	393
FF1A215LM	7314150456109	1	297,90	393
FF1A216LM	7314150456123	1	229,15	393
FF1A218LM	7314150456130	1	630,17	393
FF1A219LM	7314150456147	1	366,65	393
FF1A22	7314150254385	1	837,70	406
FF1A220LM	7314150456154	1	309,36	394
FF1A221LM	7314150456161	1	572,89	394
FF1A222LM	7314150456178	1	389,56	394
FF1A223LM	7314150456185	1	332,27	394
FF1A224LM	7314150456192	1	274,99	394
FF1A225LM	7314150456208	1	286,44	394
FF1A23	7314150254392	1	464,30	406
FF1A230	7314150461455	1	510,82	406

			€	
FF1A2301	7314150286508	1	799,75	407
FF1A235	7314150500666	1	430,73	407
FF1A236	7314150500680	1	453,20	407
FF1A24	7314150254408	1	411,12	407
FF1A25	7314150254415	1	649,66	407
FF1A2501	7314150286492	1	976,78	408
FF1A2503	7314150320677	1	681,61	408
FF1A26	7314150254422	1	469,64	408
FF1A28	7314150254446	1	550,46	408
FF1A29NB	7314150266340	1	315,27	409
FF1A3001	7314150286515	1	273,92	409
FF1A3002	7314150289264	1	347,33	409
FF1A3003	7314150286522	1	307,69	409
FF1A3004	7314150286676	1	535,81	409
FF1A3005	7314150286638	1	569,00	409
FF1A30NB	7314150266357	1	219,56	409
FF1A31NB	7314150266364	1	123,89	410
FF1A35	7314150264124	1	365,92	410
FF1A36	7314150265862	1	483,95	410
FF1A37	7314150265855	1	352,93	410
FF1A39	7314150266920	1	299,81	410
FF1A4001	7314150286713	1	432,70	410
FF1A4002	7314150286560	1	388,55	411
FF1A4003	7314150286706	1	316,48	411
FF1A41	7314150266982	1	138,11	411
FF1A48	7314150271801	1	371,53	411
FF1A50	7314150271825	1	529,17	411
FF1A5002	7314150286447	1	327,41	411
FF1A5003	7314150286690	1	1.033,05	412
FF1A5004	7314150286539	1	734,96	412
FF1A5005	7314150286546	1	1.019,46	412
FF1A5006	7314150286683	1	496,69	412
FF1A5007	7314150286553	1	746,21	413
FF1A5008	7314150286607	1	548,85	413
FF1A5009	7314150286669	1	484,84	413
FF1A5010	7314150286584	1	348,10	413
FF1A5011	7314150286614	1	349,69	413
FF1A5012	7314150286652	1	270,27	414
FF1A5013	7314150286577	1	538,18	414
FF1A5015	7314150307401	1	237,08	414
FF1A5017	7314150307425	1	233,63	414
FF1A5019	7314150309436	1	592,70	414
FF1A5021	7314150309467	1	293,28	414
FF1A5022	7314150309474	1	416,54	415
FF1A5023	7314150309498	1	274,87	415
FF1A5024	7314150309504	1	635,55	415
FF1A5027	7314150320684	1	770,51	415
FF1A5028	7314150320691	1	266,72	415
FF1A5029	7314150320707	1	426,76	416
FF1A5030	7314150320714	1	563,07	416
FF1A5031	7314150320721	1	343,77	416
FF1A5032	7314150320738	1	675,68	416
FF1A5036	7314150339037	1	260,79	416
FF1A5037	7314150339044	1	1.524,93	416
FF1A5038	7314150339051	1	243,07	417
FF1A51	7314150271832	1	313,73	417
FF1A53	7314150271856	1	201,57	417
FF1A54	7314150288786	1	268,99	417
FF1A55	7314150299720	1	385,27	417
FF1A56	7314150299737	1	349,69	417
FF1A65	7314150313389	1	441,57	418
FF1A66	7314150313396	1	304,88	418
FF1A67	7314150313402	1	377,86	418
FF1A68	7314150313419	1	266,72	418
FF1A70	7314150320189	1	317,46	418
FF1A71	7314150320196	1	195,60	418
FF1A72	7314150320202	1	347,03	419
FF1A82	7314150334070	1	194,78	419
FF1ASET-AUTO	7314150437993	1	3.288,79	387
FF1ASET-AUTO-M1	7314150438259	1	887,97	388
FF1ASET-AUTO-M2	7314150438327	1	1.798,86	388
FF1ASET-AUTO-M3	7314150438334	1	922,35	388
FF1ASET-AUTO-M4	7314150438341	1	1.317,64	389
FF1ASET-AUTO-M5	7314150438358	1	572,89	389
FF1ASET-AUTO-M6	7314150438365	1	1.048,38	389
FF1ASET-AUTO1	7314150254453	1	2.397,98	387
FF1ASET-AUTO2	7314150254460	1	1.694,48	388
FF1ASET-AUTO3	7314150254477	1	1.444,89	388
FF1ASET-AUTO6	7314150319909	1	1.410,55	388
FF1ASET-BASIC	7314150437368	1	901,77	387
FF1ASET-LARGE	7314150437108	1	2.068,76	386
FF1ASET-MRO2	7314150336623	1	2.833,78	387
FF1ASET-MRO3	7314150336630	1	2.044,83	387
FF1ASET-MRO4	7314150336647	1	1.375,07	387
FF1ASET-MRO5	7314150336654	1	1.096,63	387
FF1ASET-XLARGE	7314150436965	1	4.743,50	386
FF1B01LM	7314150455416	1	664,55	384
FF1B02LM	7314150455447	1	859,33	384
FF1B03LM	7314150455454	1	607,26	385
FF1B04LM	7314150455478	1	744,75	385
FF1B05LM	7314150455515	1	744,75	385
FF1B06LM	7314150455522	1	401,02	385
FF1B07LM	7314150455614	1	687,46	385
FF1B08LM	7314150455645	1	401,02	386
FF1B09LM	7314150455669	1	320,82	386
FF1B10LM	7314150455706	1	423,94	386

			€	
FF1B11LM	7314150455713	1	412,48	386
FF1BSET-MONSTER	7314150436835	1	6.868,90	384
FF1E1001	7314150285839	1	93,65	425
FF1E1002	7314150285761	1	90,10	425
FF1E1003	7314150285853	1	85,35	425
FF1E1004	7314150285754	1	94,83	425
FF1E1005	7314150285785	1	86,54	426
FF1E1006	7314150285778	1	88,90	426
FF1E1007	7314150285792	1	77,05	426
FF1E1008	7314150285822	1	91,28	426
FF1E1009	7314150285808	1	71,13	426
FF1E1009EH	7314150352579	1	51,56	433
FF1E1010	7314150285815	1	86,54	426
FF1E1011	7314150285846	1	101,95	426
FF1E1012EH	7314150352562	1	51,56	433
FF1E1013EH	7314150352586	1	91,66	433
FF1E2001	7314150285945	1	316,89	426
FF1E2002	7314150285921	1	334,28	427
FF1E2003	7314150286072	1	199,15	427
FF1E2004	7314150285952	1	210,24	427
FF1E2005	7314150285976	1	177,41	427
FF1E2006	7314150285914	1	323,54	427
FF1E2007	7314150285907	1	182,26	427
FF1E2008	7314150285860	1	189,82	428
FF1E2009EH	7314150352593	1	108,85	434
FF1E2010EH	7314150352654	1	57,29	434
FF1E2011EH	7314150373802	1	68,75	435
FF1E2101	7314150285877	1	276,19	428
FF1E2102	7314150286058	1	292,79	428
FF1E2103	7314150286089	1	353,06	428
FF1E2104	7314150285990	1	255,04	429
FF1E2105	7314150286041	1	324,81	428
FF1E2106EH	7314150352623	1	103,12	434
FF1E2107EH	7314150352661	1	74,48	434
FF1E2201	7314150286010	1	264,07	429
FF1E2202	7314150285891	1	233,29	429
FF1E2203	7314150285884	1	245,50	429
FF1E2204	7314150285983	1	193,32	429
FF1E2205	7314150285938	1	272,64	429
FF1E2206	7314150286034	1	267,90	429
FF1E2207	7314150285969	1	282,14	430
FF1E2208	7314150286027	1	163,85	430
FF1E2209	7314150286096	1	286,87	430
FF1E2210	7314150286065	1	225,23	430
FF1E2211	7314150339006	1	314,13	430
FF1E2212	7314150339013	1	124,48	430
FF1E2213	7314150339020	1	248,94	431
FF1E2214EH	7314150352647	1	229,15	434
FF1E2215EH	7314150352678	1	91,66	434
FF1E2216EH	7314150373833	1	143,22	436
FF1E2501	7314150286003	1	220,29	431
FF1E2502	7314150338993	1	94,83	431
FF1E2503EH	7314150352685	1	143,22	434
FF1E2504EH	7314150374106	1	91,66	436
FF1E2505EH	7314150373826	1	91,66	436
FF1E3001	7314150286119	1	111,86	431
FF1E3002	7314150286102	1	87,27	431
FF1E3003	7314150286157	1	119,06	432
FF1E3004	7314150286133	1	277,38	432
FF1E3005	7314150286126	1	245,38	432
FF1E3006	7314150286140	1	296,35	432
FF1E3007	7314150286164	1	92,46	432
FF1E3008	7314150286171	1	194,41	432
FF1E3009EH	7314150352722	1	85,93	434
FF1E3010EH	7314150352739	1	91,66	435
FF1E3011EH	7314150352753	1	108,85	435
FF1E4001	7314150285747	1	142,00	432
FF1E4002	7314150285730	1	101,71	432
FF1E4003EH	7314150352692	1	97,39	435
FF1E4004EH	7314150352708	1	108,85	435
FF1E4005EH	7314150352807	1	120,31	435
FF1E5001	7314150285716	1	201,34	433
FF1E5002	7314150285709	1	112,60	433
FF1E5003	7314150285723	1	106,68	433
FF1E5004	7314150338931	1	100,75	433
FF1E5005	7314150338948	1	160,04	431
FF1E5006	7314150338955	1	118,54	431
FF1E5007	7314150338962	1	171,89	432
FF1E5008	7314150338979	1	112,60	433
FF1E5009	7314150338986	1	82,98	431
FF1E5010EH	7314150352746	1	103,12	435
FF1E5011EH	7314150352777	1	97,39	435
FF1E5013EH	7314150352821	1	91,66	435
FF1E5014EH	7314150373864	1	103,12	436
FF1E5015EH	7314150373871	1	57,29	436
FF1E5016EH	7314150373888	1	28,64	436
FF1F1001	7314150286270	1	112,60	419
FF1F1002	7314150286287	1	153,96	419
FF1F1003	7314150286294	1	188,48	419
FF1F1004	7314150286263	1	139,87	419
FF1F1005	7314150286300	1	220,49	419
FF1F1006	7314150286249	1	129,22	420
FF1F1007	7314150286256	1	97,20	420
FF1F1008	7314150339129	1	130,40	420
FF1F1009	7314150339136	1	112,60	420
FF1F2001	7314150286317	1	451,72	420





FF1F2002	7314150339143	1	160,04	420
FF1F2101	7314150286331	1	560,70	420
FF1F2102	7314150339105	1	177,81	421
FF1F2103	7314150339112	1	137,49	421
FF1F2201	7314150286324	1	413,71	421
FF1F2202	7314150339150	1	183,74	421
FF1F2203	7314150339167	1	367,47	421
FF1F3001	7314150286348	1	113,62	421
FF1F3002	7314150286379	1	198,29	422
FF1F3003	7314150286409	1	264,61	422
FF1F3004	7314150286386	1	160,04	422
FF1F3005	7314150286362	1	416,08	422
FF1F3006	7314150286355	1	272,64	422
FF1F3007	7314150286393	1	178,93	422
FF1F3008	7314150286423	1	412,53	422
FF1F3009	7314150286416	1	272,64	422
FF1F3010	7314150339082	1	195,60	423
FF1F3011	7314150339099	1	201,53	423
FF1F4001	7314150286195	1	289,24	423
FF1F4002	7314150286201	1	269,09	423
FF1F4003	7314150286225	1	155,03	423
FF1F4004	7314150286232	1	193,05	423
FF1F4005	7314150286218	1	218,23	423
FF1F5001	7314150286188	1	215,25	424
FF1F5002	7314150339174	1	130,40	424
FF1F5003	7314150339181	1	189,67	424
FF1F5004	7314150339198	1	171,89	421
FF1F5005	7314150339204	1	88,90	424
FF1F5006	7314150339211	1	325,98	424
FF1F5007	7314150339228	1	201,53	424
FF1F5008	7314150339235	1	106,68	424
FF1F5009	7314150339242	1	243,02	425
FF1F5010	7314150339259	1	207,45	425
FF1F5011	7314150339266	1	910,89	425
FF1F5012	7314150339273	1	426,76	425
FF1F5013	7314150339280	1	213,11	421
FF2A07	7314150228201	1	1.004,15	444
FF2A08	7314150228225	1	447,64	444
FF2A09	7314150228249	1	517,04	445
FF2A10	7314150228263	1	551,82	445
FF2B01	7314150233441	1	971,98	445
FF2B02	7314150233465	1	729,97	445
FF2B03	7314150233489	1	796,43	445
FF2B04	7314150233502	1	450,70	446
FF2B05	7314150233526	1	743,46	446
FF2B06	7314150233540	1	107,02	446
FF2B07	7314150229420	1	958,62	446
FF2B08	7314150229451	1	447,85	446
FF2B09	7314150229482	1	532,97	446
FF2B10	7314150229505	1	496,29	447
FF2B11	7314150229529	1	123,82	447
FF2B12	7314150229543	1	1.081,98	447
FF2B13	7314150229567	1	489,81	447
FF2B14	7314150229581	1	342,44	447
FF2B15	7314150229604	1	343,35	448
FF2B16	7314150229628	1	85,23	448
FF3A01	7314150228300	1	968,17	458
FF3A02	7314150228324	1	269,26	459
FF3A03	7314150228348	1	469,09	459
FF3A04	7314150228362	1	514,40	459
FF3A05	7314150228386	1	1.071,23	459
FF3A06	7314150228416	1	286,15	459
FF3A07	7314150228430	1	467,57	460
FF3A08	7314150228454	1	371,79	460
FF3A09	7314150228478	1	1.122,25	460
FF3A10	7314150228492	1	254,58	460
FF3A11	7314150228515	1	338,31	448
FF3A12	7314150228539	1	368,33	449
FF3A13	7314150228614	1	673,95	449
FF3A14	7314150228638	1	917,32	449
FF3A15	7314150228652	1	259,59	449
FF3A16	7314150228676	1	461,17	449
FF3A17	7314150228690	1	455,08	450
FFSS-1.5-900FG	7311518275884	4	67,99	600
FGS-1.0-600	7311518123796	4	46,39	600
FGS-1.25-700	7311518123802	4	48,89	600
FGS-1.25-700-WB	7314150398720	4	51,68	600
FGS-1.6-810	7311518123819	4	55,09	600
FGS-1.6-810-WB	7314150399086	4	57,90	600
FGS-1.8-810	7311518123826	4	59,94	600
FM10	7311518010881	5	18,55	31
FM12	7314150273249	5	18,55	31
FP-3M	7311518168612	1	98,95	626
FS-5	7311518266455	10	16,31	632
FS-7.5	7311518266479	10	27,39	633
FS-8	7311518266462	10	22,20	632
G0313M03	7311518036089	1	14,52	144
G0313M03X	7311518182069	1	15,12	144
G0613M03X	7311518196592	1	30,25	144
G0618M06	7311518036119	1	31,48	144
G0618M06X	7311518036133	1	31,26	144
G0820M06	7311518036164	1	40,32	144
G0820M06X	7311518036188	1	42,34	144
G1020I06	7314150501519	5	33,66	147
G1020M06	7311518036218	1	48,79	144
G1020M06X	7311518036232	1	51,21	144



G1020S06	7314150501540	5	30,84	146
G1225I06	7314150501571	5	45,76	147
G1225M06	7311518036317	1	57,06	144
G1225M06X	7311518036331	1	59,88	144
G1225M08	7311518036362	1	60,07	144
G1225M08X	7311518188009	1	59,88	144
G1225S06	7314150501601	5	41,95	146
G1625M06	7311518192648	1	77,22	144
G1625M06X	7311518187415	1	81,05	144
G1625M08	7311518036409	1	77,22	144
G1625M08X	7311518036423	1	81,05	144
GL008-10	7314150167050	5	19,67	490
GL008-8	7314150167043	5	19,67	490
GL010-10	7314150167098	5	24,98	490
GL010-8	7314150167081	5	24,98	490
GS-180-F	7311518275488	6	28,62	632
GS-76	7311518010782	8	20,98	631
H0613M03X	7311518196615	1	31,84	145
H1020I06	7314150501717	5	57,45	147
H1025M06	7311518182304	1	56,24	145
H1025M06X	7311518182311	1	59,00	145
H1232I06	7314150501748	5	67,55	147
H1232M06	7311518182076	1	69,40	145
H1232M06X	7311518181758	1	72,80	145
H1635M06	7311518192730	1	86,60	145
H1635M06X	7311518187422	1	90,84	145
H1635M08	7311518182083	1	86,60	145
H1635M08X	7311518182090	1	95,83	145
HFGPS-0.7-400FG	7311518275877	4	45,49	600
HGPS-0.6-360	7311518123680	10	23,27	600
HGPS-0.8-380	7311518123697	4	28,45	600
HGPS-0.8-380-WB	7314150398812	4	32,95	600
HGPS-1.0-400	7311518123703	4	31,83	600
HGPS-1.0-400-WB	7314150398713	4	34,75	600
HRFM10	7311518010898	5	22,65	31
HS 7590	7314150109395	1	69,65	650
HS 7890	7314150109401	1	68,70	651
HS 7891	7314150109425	10	69,17	651
HS 7892	7314150109432	1	72,99	651
HS 7893	7314150109456	1	103,04	652
HS 8130	7314150107773	1	73,48	644
HS 8131	7314150107803	1	76,33	644
HS 8132	7314150107810	1	84,92	644
HS 8140	7314150107926	10	69,59	644
HS 8141	7314150107940	10	72,51	644
HS 8142	7314150107964	10	80,15	644
HS 8143	7314150107988	10	75,87	645
HS 8144	7314150108008	10	77,78	645
HS 8145	7314150108022	10	81,11	645
HS 8148	7314150108084	10	84,44	645
HS 8150	7314150108114	1	73,94	644
HS 8160	7314150108305	10	76,33	644
HS 8161	7314150108329	10	84,44	644
HS 8162	7314150108343	10	95,89	644
HS 8163	7314150108367	10	81,11	645
HS 8164	7314150402144	10	54,08	645
HS 8247	7314150108480	1	123,56	647
HS 8248	7314150108503	10	128,81	647
HS122M.030	7314150423293	5	208,65	653
HS6000	7314150113781	10	75,87	648
HS6001	7314150476466	10	57,30	648
HS7190	7314150475988	1	60,11	645
HS7191	7314150476473	1	60,11	645
HS7280	7314150476480	1	60,11	647
HS7285	7314150476497	1	60,11	647
HS7290	7314150476503	1	60,11	646
HS7291	7314150476510	1	69,59	646
HS7292	7314150383719	10	73,58	646
HS7293	7314150476527	1	60,11	646
HS7490	7314150350674	10	101,13	650
HS7894	7314150476534	1	89,02	652
HS8133	7314150476541	1	63,48	645
HS8134	7314150476555	1	63,48	645
HS8135	7314150476572	1	63,48	645
HS8136	7314150476589	1	63,48	645
HS8137	7314150476596	1	63,48	645
HS8138	7314150476602	1	63,48	645
HS8146	7314150425372	10	77,50	645
HS8147	7314150351954	10	77,50	645
HS8149	7314150476619	1	66,95	648
HS8151	7314150349388	10	72,10	644
HS8152	7314150476626	10	83,46	644
HS8153	7314150360055	10	89,41	645
HS8154	7314150349418	10	77,25	645
HS8155	7314150476633	1	77,25	645
HS8156	7314150476640	1	82,40	645
HS8157	7314150476657	1	82,40	645
HS8158	7314150476664	1	82,40	645
HS8165	7314150374526	10	101,34	645
HS8166	7314150476671	1	92,70	645
HS8167	7314150476688	1	92,70	645
HS8168	7314150476695	1	92,70	645
HS8211	7314150365067	10	137,11	646
HUS-0.6-380	7311518123659	4	33,53	600
HUS-0.8-500	7311518123666	4	37,50	600
HUS-1.0-650	7311518123673	4	42,20	600



IZO-D-135	7314151845827	1	745,95	105
IZO-D-200	7314151846831	1	817,83	105
IZO-D-30	7314151846824	1	745,95	105
IZO-D-340	7314151846848	1	942,40	105
IZO-DR-810	7314151846817	1	2.239,72	105
J0604M06	7311518036508	1	36,49	145
J1010M06	7311518172473	1	40,74	145
J1212M06	7311518036577	1	48,13	145
J1616M06	7311518187439	1	70,52	145
J1616M08	7311518036614	1	66,85	145
K-AP-1	7311518030117	10	31,44	632
K-GP-1	7311518030131	10	34,46	632
K0602M06	7311518036652	1	36,49	145
K1008M06	7311518036683	1	42,99	145
K1210M06	7311518036720	1	45,62	145
K1612M06	7311518193959	1	62,69	145
K1612M08	7311518036768	1	59,43	145
K172	7314150384396	1	32,66	173
K18NF-2	7314151347161	1	7,54	170
K18PH-2M5	73141503019646	1	8,37	170
K18PH-2M6	7314150274871	1	8,41	170
K19PZD-2M5	7314151693237	1	7,54	170
K19PZD-2NF	7314151586157	1	7,54	170
K20TORX-T25	7314151825799	1	10,66	170
K560F-1	7314151825492	5	3,24	173
K560F-2	7314151825324	5	3,24	174
K560F-3	7314151825331	5	3,24	174
K560F-4	7314151825348	5	3,46	178
K560F-5	7314151825355	5	3,46	178
K560F-6	7314151825362	5	3,93	181
K560F-7	7314151825379	5	4,44	183
K560F-8	7314151825508	5	5,82	183
K560F-9	7314151846688	5	6,88	185
K66100-1/4	7314150204540	1	54,27	172
K66100-1/4-1P	7314150260201	1	10,86	172
K66100-3/8	7314150204564	1	68,69	172
K66100-3/8-1P	7314150260249	1	13,74	172
K6625-1/4-1P	7314150260140	1	5,29	172
K6625-1/4B-5P	7314150533305	1	26,45	172
K6638-3/8	7314150204557	1	30,91	172
K6638-3/8-1P	7314150260164	1	6,19	172
K6650-1/2-1P	7314150260188	1	14,42	172
K6650-1/2P-5P	7314150533367	1	72,14	172
K6650-1/4B-1P	7314150533381	1	8,74	172
K6650-1/4P-5P	7314150533404	1	43,61	172
K6650-3/8-1P	7314150260225	1	11,68	172
K6650-3/8P-5P	7314150533442	1	58,40	172
K6660-QR-1P	7314150204571	1	14,15	172
K6701M-10	7314151778149	1	7,39	172
K6701M-11	7314151778224	1	7,39	172
K6701M-12	7314151811891	1	9,21	172
K6701M-13	7314151778491	1	9,21	172
K6701M-14	7314151844172	1	9,21	172
K6701M-6	7314151813260	1	7,35	172
K6701M-7	7314151777920	1	7,35	172
K6701M-8	7314151778064	1	7,39	172
K6701M-9	7314151815110	1	7,39	172
K6750-1/4	7314150204663	1	6,08	170
K6750-10-1P	7314150533466	1	6,08	170
K6750-13	7314150204823	1	6,08	170
K6750-3/8	7314150204656	1	6,08	170
K6750-6	7314150204670	1	6,08	170
K6750-7	7314150204687	1	6,08	170
K6964C	7314151215170	1	23,20	174
K7401M-10	7314151780128	1	8,70	173
K7401M-11	7314151780395	1	8,70	173
K7401M-12	7314151811907	1	8,70	173
K7401M-13	7314151780470	1	8,70	173
K7401M-14	7314151780555	1	8,70	173
K7401M-15	7314151812140	1	8,70	173
K7401M-16	7314151780630	1	8,70	173
K7401M-17	7314151780715	1	8,70	173
K7401M-18	7314151812157	1	10,34	173
K7401M-19	7314151812164	1	10,34	173
K7401M-20	7314151844271	1	10,63	173
K7401M-21	7314151845216	1	10,63	173
K7401M-22	7314151845223	1	11,12	173
K7401M-24	7314151844295	1	11,29	173
K7401M-7	7314151812126	1	8,70	173
K7401M-8	7314151780043	1	8,70	173
K7401M-9	7314151812133	1	8,70	173
K7401M/10	7314150389919	1	86,46	174
K7401TORX-E-S7	7314150343324	1	79,96	175
K7401TORX-E10	7314151844448	1	11,42	174
K7401TORX-E12	7314151844455	1	11,42	174
K7401TORX-E14	7314151844462	1	11,42	174
K7401TORX-E5	7314151844400	1	11,42	174
K7401TORX-E6	7314151844417	1	11,42	174
K7401TORX-E7	7314151844424	1	11,42	174
K7401TORX-E8	7314151844431	1	11,42	174
K7401Z-1/2	7314150384402	1	9,17	173
K7401Z-11/16	7314150384419	1	9,17	173
K7401Z-13/16	7314150384426	1	9,17	173
K7401Z-3/4	7314150384433	1	9,17	173
K7401Z-3/8	7314150384440	1	9,17	173
K7401Z-5/8	7314150384457	1	9,17	173



K7401Z-7/16	7314150384464	1	9,17	173
K7401Z-7/8	7314150384471	1	9,17	173
K7401Z-9/16	7314150384488	1	9,17	173
K7406M-10	7314151844479	1	9,73	173
K7406M-13	7314151844486	1	11,05	173
K7406M-17	7314151844493	1	12,05	173
K7760C-1	7314151222369	1	16,02	174
K7760C-2	7314151222376	1	23,03	174
K7764D	7314151222475	1	24,02	177
K7767S	7314151222512	1	33,88	174
K7800M-10	7314150326297	1	6,35	175
K7800M-11	7314150326303	1	6,35	175
K7800M-12	7314150326310	1	6,35	175
K7800M-13	7314150326327	1	6,35	175
K7800M-14	7314150326334	1	6,46	175
K7800M-15	7314150326341	1	6,46	175
K7800M-16	7314150326358	1	6,46	175
K7800M-17	7314150326365	1	6,75	175
K7800M-18	7314150326372	1	6,75	175
K7800M-19	7314150326389	1	6,75	175
K7800M-21	7314150326396	1	6,75	175
K7800M-22	7314150326402	1	6,86	175
K7800M-24	7314150326419	1	7,42	175
K7800M/13	7314150437221	1	81,34	178
K7801M-10	7314151778576	1	10,29	175
K7801M-11	7314151778651	1	10,29	175
K7801M-12	7314151815790	1	10,29	175
K7801M-13	7314151778736	1	10,29	175
K7801M-14	7314151778811	1	10,65	175
K7801M-15	7314151815806	1	10,86	175
K7801M-16	7314151779030	1	10,86	175
K7801M-17	7314151779115	1	11,37	175
K7801M-18	7314151779382	1	11,37	175
K7801M-19	7314151779467	1	11,37	175
K7801M-20	7314151844509	1	11,99	175
K7801M-21	7314151779542	1	12,06	175
K7801M-22	7314151779627	1	12,20	175
K7801M-23	7314151844516	1	12,57	175
K7801M-24	7314151779894	1	12,76	175
K7801M-25	7314151844523	1	14,77	175
K7801M-26	7314151844530	1	15,18	175
K7801M-27	7314151779979	1	15,18	175
K7801M-28	7314150430154	1	15,18	175
K7801M-29	7314150430161	1	15,34	175
K7801M-30	7314151811914	1	18,60	175
K7801M-32	7314151825157	15	26,64	175
K7801M-34	7314151844547	1	30,09	175
K7801M-36	7314151844554	1	31,10	175
K7801M-8	7314151845230	1	6,08	175
K7801M-9	7314151845247	1	6,08	175
K7801TORX-E10	7314151811587	1	13,63	177
K7801TORX-E12	7314151811594	1	13,63	177
K7801TORX-E14	7314151811600	1	13,63	177
K7801TORX-E16	7314151811617	1	13,63	177
K7801TORX-E18	7314151811624	1	13,63	177
K7801TORX-E20	7314151811631	1	14,77	177
K7801TORX-E24	7314151811648	1	14,77	177
K7801VM-17	7314151781521	1	12,96	176
K7801VM-19	7314151781798	1	12,96	176
K7801VM-22	7314151781873	1	13,82	176
K7801VM-24	7314151781958	1	14,17	176
K7801VM/S4	7314151799090	1	61,36	178
K7801Z-1	7314151844639	1	13,35	176
K7801Z-1.1/16	7314151844646	1	14,45	176
K7801Z-1.1/2	7314150137701	5	34,36	176
K7801Z-1.1/4	7314151844660	1	25,73	176
K7801Z-1.1/8	7314151844653	1	15,37	176
K7801Z-1.3/8	7314150137688	5	29,88	176
K7801Z-1.5/16	7314150137671	5	29,88	176
K7801Z-1.7/16	7314150137695	5	29,88	176
K7801Z-1/2	7314151822620	1	10,36	176
K7801Z-11/16	7314151844592	1	10,73	176
K7801Z-13/16	7314151844608	1	10,89	176
K7801Z-15/16	7314151844622	1	12,78	176
K7801Z-3/4	7314151822668	1	10,74	176
K7801Z-3/8	7314151822606	1	10,36	176
K7801Z-5/8	7314151844585	1	10,73	176
K7801Z-7/16	7314151844561	1	10,36	176
K7801Z-7/8	7314151844615	1	10,89	176
K7801Z-9/16	7314151822637	1	10,73	176
K7801Z/10	7314150165018	1	113,44	178
K7806M-10	7314151844677	1	12,54	175
K7806M-11	7314151844684	1	12,54	175
K7806M-12	7314151844691	1	12,54	175
K7806M-13	7314151805944	1	12,54	175
K7806M-14	7314151844707	1	12,54	175
K7806M-15	7314150330683	1	12,68	175
K7806M-16	7314151844714	1	12,68	175
K7806M-17	7314151805951	1	12,68	175
K7806M-18	7314151844721	1	12,72	175
K7806M-19	7314151805968	1	12,72	175
K7806M-21	7314151823597	1	12,72	175
K7806M-22	7314151805975	1	12,72	175
K7806M-23	7314151844738	1	13,31	175
K7806M-24	7314151805982	1	13,13	175
K7806M-27	7314151805999	1	15,32	175



K7806M-30



K7806M-30	7314151844578	1	17,32	175
K7806M-32	7314150220304	1	20,23	175
K7806M-36	7314150220311	1	23,42	175
K7806M/S4	7314151813222	1	51,24	178
K7806Z-1	7314150137817	5	15,77	176
K7806Z-1.1/16	7314150137824	5	16,84	176
K7806Z-1.1/2	7314150137886	5	39,35	176
K7806Z-1.1/4	7314150137848	5	29,48	176
K7806Z-1.1/8	7314150137831	5	19,06	176
K7806Z-1.3/8	7314150137862	5	34,24	176
K7806Z-1.5/16	7314150137855	5	34,24	176
K7806Z-1.7/16	7314150137879	5	34,24	176
K7806Z-1/2	7314150137749	10	13,78	176
K7806Z-11/16	7314150137770	5	13,94	176
K7806Z-13/16	7314150137794	5	13,98	176
K7806Z-15/16	7314150137718	5	14,43	176
K7806Z-3/4	7314150137787	5	13,98	176
K7806Z-3/8	7314150137725	10	13,78	176
K7806Z-5/8	7314150137763	5	13,94	176
K7806Z-7/16	7314150137732	5	13,78	176
K7806Z-7/8	7314150137800	5	13,98	176
K7806Z-9/16	7314150137756	10	13,78	176
K7806Z/10	7314150165025	1	141,37	178
K8160D-1	7314151237400	1	14,10	177
K8160D-2	7314151237417	1	17,36	177
K8160D-3	7314151237424	1	27,51	177
K8164C	7314151237523	1	23,20	174
K8164F	7314151237554	1	33,68	180
K8167S	7314151237592	1	34,64	177
K8901M-17	7314151803155	1	23,17	179
K8901M-18	7314151844189	1	23,15	179
K8901M-19	7314151803162	1	23,17	179
K8901M-21	7314151803179	1	23,26	179
K8901M-22	7314151803186	1	23,26	179
K8901M-23	7314151803193	1	23,26	179
K8901M-24	7314151803209	1	24,15	179
K8901M-27	7314151803216	1	25,49	179
K8901M-28	7314151803223	1	26,66	179
K8901M-29	7314151803230	1	29,88	179
K8901M-30	7314151803247	1	32,66	179
K8901M-32	7314151803254	1	32,56	179
K8901M-33	7314151803261	1	33,39	179
K8901M-34	7314151803278	1	33,36	179
K8901M-36	7314151803285	1	35,18	179
K8901M-38	7314151803292	1	36,73	179
K8901M-41	7314151803308	1	43,67	179
K8901M-46	7314151803315	1	44,35	179
K8901M-50	7314151846398	1	72,67	179
K8901M-55	7314151846404	1	87,58	179
K8901M-60	7314151846411	1	102,80	179
K8901M/8	7314150165032	1	238,09	181
K8901Z-1	7314151844752	1	29,07	180
K8901Z-1.1/16	7314151844769	1	29,07	180
K8901Z-1.1/2	7314151844820	1	39,18	180
K8901Z-1.1/4	7314151844783	1	29,77	180
K8901Z-1.1/8	7314151844776	1	29,07	180
K8901Z-1.11/16	7314150130269	1	46,90	180
K8901Z-1.13/16	7314150130276	1	46,35	180
K8901Z-1.15/16	7314150130290	1	65,79	180
K8901Z-1.3/16	7314150130245	1	29,07	180
K8901Z-1.3/4	7314151844844	1	51,41	180
K8901Z-1.3/8	7314151844806	1	30,56	180
K8901Z-1.5/16	7314151844790	1	29,77	180
K8901Z-1.5/8	7314151844837	1	43,20	180
K8901Z-1.7/16	7314151844813	1	30,56	180
K8901Z-1.7/8	7314150130283	1	59,51	180
K8901Z-1.9/16	7314150130252	1	36,74	180
K8901Z-11/16	7314150130238	1	27,79	180
K8901Z-13/16	7314151844226	1	27,79	180
K8901Z-15/16	7314151844745	1	27,79	180
K8901Z-2	7314150130306	1	65,79	180
K8901Z-2.1/16	7314150130313	1	74,57	180
K8901Z-2.1/4	7314150130344	1	86,61	180
K8901Z-2.3/16	7314150130337	1	82,60	180
K8901Z-2.3/8	7314150130351	1	93,07	180
K8901Z-3/4	7314151844202	1	27,79	180
K8901Z-7/8	7314151844301	1	27,79	180
K8901Z/18	7314150436514	1	516,55	181
K8901Z/8	7314150165049	1	247,09	181
K8906M-17	7314151803056	1	42,73	179
K8906M-19	7314151803063	1	43,71	179
K8906M-21	7314151844851	1	44,43	179
K8906M-22	7314151803070	1	44,43	179
K8906M-24	7314151803087	1	45,14	179
K8906M-27	7314151803094	1	46,84	179
K8906M-30	7314151803117	1	47,83	179
K8906M-32	7314151803124	1	50,94	179
K8906M-33	7314151844868	1	51,67	179
K8906M-34	7314151844875	1	54,42	179
K8906M-36	7314151803148	1	56,30	179
K8906M-41	7314151845254	1	58,73	179
K8906M-42	7314150512607	1	42,69	179
K8906M-46	7314150220601	1	67,58	179
K8906M/8	7314150165056	1	370,28	181
K8906Z-1	7314150130436	1	46,69	180
K8906Z-1.1/16	7314150130443	1	46,69	180



K8906Z-1.1/2	7314150130511	1	57,73	180
K8906Z-1.1/4	7314150130474	1	48,55	180
K8906Z-1.1/8	7314150130450	1	46,69	180
K8906Z-1.3/4	7314150130559	1	69,94	180
K8906Z-1.3/8	7314150130498	1	56,00	180
K8906Z-1.5/16	7314150130481	1	55,47	180
K8906Z-1.5/8	7314150130535	1	57,73	180
K8906Z-1.7/16	7314150130504	1	56,00	180
K8906Z-13/16	7314150130405	1	46,69	180
K8906Z-15/16	7314150130429	1	46,69	180
K8906Z-2	7314150130580	1	105,65	180
K8906Z-3/4	7314150130399	1	46,69	180
K8906Z-7/8	7314150130412	1	46,69	180
K8906Z/8	7314150165063	1	413,80	181
K8909H-5	7314151619343	1	60,95	180
K8909ML-12	7314151232863	1	18,29	183
K8909ML-14	7314151232870	1	18,29	183
K8909ML-17	7314151232887	1	18,29	183
K8960F-2	7314151268138	1	45,94	181
K8960F-3	7314151268145	1	55,15	181
K8960F-4	7314150220625	1	59,76	181
K8964D	7314151268237	1	16,59	177
K8964G	7314151268268	1	35,75	182
K8967S	7314151268329	1	92,02	180
K9501M-22	7314151844882	1	43,37	182
K9501M-24	7314151802677	1	43,37	182
K9501M-27	7314151802684	1	44,73	182
K9501M-30	7314151802714	1	45,96	182
K9501M-32	7314151802721	1	48,26	182
K9501M-33	7314151802738	1	49,64	182
K9501M-34	7314151802745	1	51,18	182
K9501M-36	7314151802752	1	51,18	182
K9501M-38	7314151802769	1	51,58	182
K9501M-41	7314151802776	1	58,12	182
K9501M-42	7314151802783	1	68,47	182
K9501M-46	7314151802790	1	71,48	182
K9501M-50	7314151802806	1	79,66	182
K9501M-55	7314151802813	1	91,20	182
K9501M-60	7314151802820	1	111,09	182
K9501M-65	7314151802837	1	132,93	182
K9501M-70	7314151802844	1	151,57	182
K9501M-75	7314151802851	1	158,49	182
K9501M-80	7314151802868	1	166,83	182
K9501M-85	7314150352197	1	261,98	182
K9501Z-1	7314151844912	1	43,82	182
K9501Z-1.1/16	7314150130634	1	43,82	182
K9501Z-1.1/2	7314151844943	1	55,91	182
K9501Z-1.1/4	7314151844929	1	43,82	182
K9501Z-1.1/8	7314150130641	1	43,82	182
K9501Z-1.11/16	7314150130696	1	68,79	182
K9501Z-1.13/16	7314151844967	1	74,85	182
K9501Z-1.15/16	7314150130719	1	77,53	182
K9501Z-1.3/16	7314150130658	1	43,82	182
K9501Z-1.3/4	7314150130702	1	68,79	182
K9501Z-1.3/8	7314150130672	1	54,56	182
K9501Z-1.5/16	7314150130665	1	48,74	182
K9501Z-1.5/8	7314151844950	1	59,82	182
K9501Z-1.7/16	7314151844936	1	54,56	182
K9501Z-1.7/8	7314151844974	1	74,85	182
K9501Z-1.9/16	7314150130689	1	55,91	182
K9501Z-2	7314150130726	1	87,70	182
K9501Z-2.1/4	7314150130764	1	107,05	182
K9501Z-2.1/8	7314150130740	1	98,54	182
K9501Z-2.3/16	7314150130757	1	98,54	182
K9501Z-2.3/4	7314150130832	1	155,07	182
K9501Z-2.5/16	7314150130771	1	107,05	182
K9501Z-2.9/16	7314150130801	1	147,64	182
K9506M-22	7314151844998	1	72,10	182
K9506M-24	7314151802530	1	72,10	182
K9506M-27	7314151802547	1	72,10	182
K9506M-30	7314151802554	1	72,81	182
K9506M-32	7314151802561	1	74,83	182
K9506M-33	7314151802578	1	75,85	182
K9506M-34	7314151845018	1	77,86	182
K9506M-36	7314151802585	1	77,86	182
K9506M-38	7314151802592	1	79,33	182
K9506M-41	7314151802608	1	87,57	182
K9506M-46	7314151802615	1	95,25	182
K9506M-50	7314151802622	1	115,77	182
K9506M-55	7314151802639	1	140,96	182
K9506M-60	7314151802646	1	172,26	182
K9506Z-1	7314150131686	1	64,50	182
K9506Z-1.1/16	7314150131693	1	65,52	182
K9506Z-1.1/2	7314150131761	1	67,93	182
K9506Z-1.1/4	7314150131723	1	65,73	182
K9506Z-1.13/16	7314150131808	1	94,12	182
K9506Z-1.3/16	7314150131716	1	65,52	182
K9506Z-1.5/8	7314150131785	1	73,42	182
K9506Z-1.7/16	7314150131754	1	65,73	182
K9506Z-1.7/8	7314150131815	1	106,15	182
K9509H5	7314151619428	1	97,16	182
K9509ML-19	7314151618964	1	18,77	183
K9509ML-22	7314151619183	1	24,61	183
K9509ML-24	7314151619268	1	24,68	183
K9560G-0	7314150240012	1	55,47	180
K9560G-1	7314151285944	1	60,57	183



€



K9560G-2	7314151285951	1	66,26	183
K9560G-3	7314151285968	1	77,33	183
K9560G-4	7314150133970	1	66,49	183
K9560G-5	7314150133987	1	81,26	183
K9564F	7314151286026	1	37,34	180
K9567S	7314151286095	1	193,31	183
K9598H	7314150133956	1	274,25	184
K9801M-100	7314151845162	1	538,35	183
K9801M-105	7314151845179	1	582,87	183
K9801M-110	7314151845186	1	736,18	183
K9801M-115	7314151845193	1	776,42	183
K9801M-120	7314151845209	1	835,88	183
K9801M-125	7314150167159	1	862,83	183
K9801M-130	7314150167166	1	958,70	183
K9801M-135	7314150167173	1	1.054,56	183
K9801M-140	7314150167180	1	1.102,50	183
K9801M-145	7314150167197	1	1.214,35	183
K9801M-150	7314150167203	1	1.438,07	183
K9801M-155	7314150167210	1	1.629,79	183
K9801M-46	7314151845056	1	202,35	183
K9801M-50	7314151845063	1	202,35	183
K9801M-55	7314151845070	1	214,30	183
K9801M-60	7314151845087	1	237,97	183
K9801M-65	7314151845094	1	258,86	183
K9801M-70	7314151845100	1	279,56	183
K9801M-75	7314151845117	1	303,32	183
K9801M-80	7314151845124	1	332,98	183
K9801M-85	7314151845131	1	382,60	183
K9801M-90	7314151845148	1	424,22	183
K9801M-95	7314151845155	1	501,30	183
K9801Z-1.1/2	7314150131976	1	128,37	184
K9801Z-1.11/16	7314150132003	1	131,16	184
K9801Z-1.13/16	7314150132027	1	138,13	184
K9801Z-1.15/16	7314150132041	1	138,13	184
K9801Z-1.3/4	7314150132010	1	138,13	184
K9801Z-1.3/8	7314150131952	1	128,77	184
K9801Z-1.5/8	7314150131990	1	131,16	184
K9801Z-1.7/16	7314150131969	1	128,37	184
K9801Z-1.7/8	7314150132034	1	138,13	184
K9801Z-1.9/16	7314150131983	1	132,47	184
K9801Z-2	7314150132058	1	138,13	184
K9801Z-2.1/16	7314150132065	1	139,48	184
K9801Z-2.1/2	7314150132133	1	190,50	184
K9801Z-2.1/4	7314150132096	1	159,38	184
K9801Z-2.1/8	7314150132072	1	141,17	184
K9801Z-2.11/16	7314150132164	1	220,06	184
K9801Z-2.13/16	7314150132188	1	207,44	184
K9801Z-2.15/16	7314150132201	1	280,05	184
K9801Z-2.3/16	7314150132089	1	143,52	184
K9801Z-2.3/4	7314150132171	1	240,84	184
K9801Z-2.3/8	7314150132119	1	189,35	184
K9801Z-2.5/16	7314150132102	1	172,48	184
K9801Z-2.5/8	7314150132157	1	206,31	184
K9801Z-2.7/16	7314150132126	1	191,23	184
K9801Z-2.7/8	7314150132195	1	262,74	184
K9801Z-2.9/16	7314150132140	1	199,22	184
K9801Z-3	7314150132218	1	294,34	184
K9801Z-3.1/16	7314150132225	1	320,74	184
K9801Z-3.1/2	7314150132287	1	371,58	184
K9801Z-3.1/4	7314150132249	1	333,84	184
K9801Z-3.1/8	7314150132232	1	336,92	184
K9801Z-3.11/16	7314150132317	1	571,16	184
K9801Z-3.13/16	7314150132331	1	555,51	184
K9801Z-3.15/16	7314150132355	1	656,12	184
K9801Z-3.3/4	7314150132324	1	558,46	184
K9801Z-3.3/8	7314150132263	1	356,48	184
K9801Z-3.5/16	7314150132256	1	343,27	184
K9801Z-3.5/8	7314150132300	1	487,78	184
K9801Z-3.7/16	7314150132270	1	367,93	184
K9801Z-3.7/8	7314150132348	1	655,38	184
K9801Z-3.9/16	7314150132294	1	416,92	184
K9801Z-4	7314150132362	1	664,99	184
K9801Z-4.1/16	7314150132379	1	672,76	184
K9801Z-4.1/2	7314150132430	1	843,93	184
K9801Z-4.1/4	7314150132393	1	714,11	184
K9801Z-4.1/8	7314150132386	1	698,42	184
K9801Z-4.3/4	7314150132454	1	1.034,29	184
K9801Z-4.3/8	7314150132416	1	805,87	184
K9801Z-4.5/16	7314150132409	1	760,26	184
K9801Z-4.5/8	7314150132447	1	863,30	184
K9801Z-4.7/16	7314150132423	1	824,49	184
K9806M-100	7314150131105	1	973,39	183
K9806M-105	7314150131112	1	1.069,91	183
K9806M-110	7314150131129	1	1.366,00	183
K9806M-115	7314150131136	1	1.521,45	183
K9806M-120	7314150131143	1	2.921,82	183
K9806M-41	7314150130986	1	413,41	183
K9806M-46	7314150130993	1	413,41	183
K9806M-50	7314150131006	1	413,41	183
K9806M-55	7314150131013	1	413,41	183
K9806M-60	7314150131020	1	423,37	183
K9806M-65	7314150131037	1	469,53	183
K9806M-70	7314150131044	1	527,92	183
K9806M-75	7314150131051	1	590,42	183
K9806M-80	7314150131068	1	714,10	183
K9806M-85	7314150131075	1	718,54	183



€



K9806M-90	7314150131082	1	758,76	183
K9806M-95	7314150131099	1	893,22	183
K9806Z-1.1/2	7314150131174	1	191,80	184
K9806Z-1.11/16	7314150131198	1	193,68	184
K9806Z-1.3/8	7314150131150	1	192,23	184
K9806Z-1.5/8	7314150131181	1	193,68	184
K9806Z-1.7/16	7314150131167	1	193,68	184
K9806Z-2	7314150131204	1	203,04	184
K9806Z-2.1/16	7314150131211	1	203,04	184
K9806Z-2.1/2	7314150131273	1	285,95	184
K9806Z-2.1/4	7314150131235	1	228,69	184
K9806Z-2.11/16	7314150131303	1	353,53	184
K9806Z-2.13/16	7314150131327	1	385,78	184
K9806Z-2.15/16	7314150131341	1	412,67	184
K9806Z-2.3/16	7314150131228	1	219,94	184
K9806Z-2.3/4	7314150131310	1	369,05	184
K9806Z-2.3/8	7314150131259	1	280,84	184
K9806Z-2.5/16	7314150131242	1	233,61	184
K9806Z-2.5/8	7314150131297	1	347,52	184
K9806Z-2.7/16	7314150131266	1	281,96	184
K9806Z-2.7/8	7314150131334	1	407,54	184
K9806Z-2.9/16	7314150131280	1	287,56	184
K9806Z-3	7314150131358	1	443,87	184
K9806Z-3.1/16	7314150131365	1	466,96	184
K9806Z-3.1/2	7314150131433	1	569,51	184
K9806Z-3.1/4	7314150131396	1	526,10	184
K9806Z-3.1/8	7314150131372	1	490,65	184
K9806Z-3.11/16	7314150131464	1	759,13	184
K9806Z-3.13/16	7314150131488	1	759,13	184
K9806Z-3.15/16	7314150131501	1	819,72	184
K9806Z-3.3/16	7314150131389	1	499,06	184
K9806Z-3.3/4	7314150131471	1	780,76	184
K9806Z-3.3/8	7314150131419	1	546,32	184
K9806Z-3.5/16	7314150131402	1	526,14	184
K9806Z-3.5/8	7314150131457	1	598,68	184
K9806Z-3.7/16	7314150131426	1	569,51	184
K9806Z-3.7/8	7314150131495	1	841,26	184
K9806Z-3.9/16	7314150131440	1	607,91	184
K9806Z-4	7314150131518	1	828,55	184
K9806Z-4.1/16	7314150131525	1	808,33	184
K9806Z-4.1/2	7314150131570	1	1.300,33	184
K9806Z-4.1/4	7314150131549	1	1.047,80	184
K9806Z-4.1/8	7314150131532	1	1.014,18	184
K9806Z-4.3/4	7314150131594	1	1.422,03	184
K9806Z-4.3/8	7314150131563	1	1.256,31	184
K9806Z-4.5/16	7314150131556	1	1.165,07	184
K9806Z-4.5/8	7314150131587	1	1.332,66	184
K9860H-1	7314150133994	1	416,85	184
K9860H-2	7314150134007	1	459,82	184
K9860H-3	7314150134014	1	463,86	184
K9867S	7314150133932	1	654,43	184
K9895G	7314150133949	1	175,52	183
K9899H	7314150166763	1	1.222,34	185
K9998H	7314150133963	1	932,29	185
KB09-01	7314150196968	5	8,58	581
KB18-01	7314150196944	5	10,87	581
KBFU-01	7314150196913	5	16,21	580
KBGH-5P-DISPEN	7314150296729	20	3,42	581
KBGR-5P-DISPEN	7314150296774	20	4,69	581
KBGU-100P	7314150213405	1	32,60	581
KBGU-10P-DISPEN	7314150262984	20	5,05	581
KBGU-5P-DISPEN	7314150296705	20	2,93	581
KBRU-01	7314150196876	5	18,01	580
KBSK-01	7314150196999	5	20,01	583
KBSU-01	7314150197002	5	20,01	583
KBTU-01	7314150196982	5	31,44	583
KBWS-01	7314150225972	10	6,02	586
KCB753	7314150204915	1	46,16	171
KE18-01	7314150196937	5	16,00	580
KEFU-01	7314150196906	5	18,77	580
KERU-01	7314150196869	5	20,87	580
KG09-01	7314150196975	5	6,15	581
KG09-01-3P	7314150213962	10	18,44	581
KG18-01	7314150196951	5	7,99	582
KGAU-01	7314150223893	5	16,40	582
KGFU-01	7314150196920	5	11,57	580
KGRU-01	7314150196883	5	12,85	580
KGRU-02	7314150196890	5	11,43	580
KGSU-01	7314150197019	5	15,43	583
KHU-01	7314150268955	4	4,82	582
KM1/4-5/16-P	7314150275953	1	6,79	172
KM653-1P	7314151840709	1	6,00	171
KM653-5P	7314150533565	1	30,02	171
KM653-QR-1P	7314151848507	1	15,31	170
KM653-QR-5P	7314150533589	1	65,95	170
KM653-SF	7314150204984	1	17,87	171
KM6701M-10	7314151844264	1	32,96	173
KM6701M-7	7314151844240	1	31,56	173
KM6701M-8	7314151844257	1	31,95	173
KM6750-1/4	7314150204595	1	7,41	170
KM6750-10-1P	7314150533626	1	7,41	170
KM6750-11	7314150302628	1	7,41	170
KM6750-13-1P	7314150533664	1	7,41	170
KM6750-3/8	7314150204588	1	7,41	170
KM6750-6	7314150204601	1	7,41	170
KM6750-7	7314150204618	1	7,41	170

KM753-QR-1P



KM753-QR-1P	7314150204830	1	17,17	171
KMR150	7314150204960	1	68,69	171
KMR150-1P	7314150204977	1	15,79	171
KMR653-5P	7314150533763	1	25,93	171
KMR653-1P	7314150204939	1	8,99	171
KMR753	7314150204946	1	41,22	171
KMR753-1P	7314150204953	1	8,23	171
KMT753-QR-1P	7314150391523	1	10,23	171
KMU-01	7314150197026	5	8,58	580
KR653	7314150204885	1	29,19	171
KR653-1P	7314150260263	1	5,84	171
KRSS-01	7314150214938	10	6,71	586
KS7401M-10	7314150384495	1	33,54	174
KS7401M-11	7314150384501	1	33,54	174
KS7401M-12	7314150384518	1	33,54	174
KS7401M-13	7314150384525	1	33,54	174
KS7401M-14	7314150384532	1	34,67	174
KS7401M-15	7314150384549	1	34,67	174
KS7401M-16	7314150384556	1	34,67	174
KS7401M-17	7314150384563	1	34,67	174
KS7401M-18	7314150384570	1	34,67	174
KS7401M-19	7314150384587	1	34,67	174
KS7401M-22	7314150384594	1	37,42	174
KS7401M-9	7314150384600	1	33,54	174
KSBG09-10DISPEN	7314150262991	20	4,50	582
KSBG18-10DISPEN	7314150263004	20	5,88	582
KSR753	7314150204892	1	99,03	529
KSR753-1P	7314150204908	1	21,92	529
KUBG09-5P	7314150213450	20	3,05	582
KUBG18-5DISPEN	7314150296835	20	4,19	582
L1020I06	7314150501649	5	40,32	147
L1020M06	7311518133665	1	58,22	145
L1020M06X	7311518136369	1	61,14	145
L1020S06	7314150501670	5	36,98	147
L1225M06	7311518132774	1	64,73	145
L1225M06X	7311518136857	1	71,65	145
L1228I06	7314150501700	5	49,26	147
L1228S06	7314150501731	5	45,15	147
L1230AL06	7311518187668	1	87,76	146
L1230AL08	7311518181871	1	87,76	146
L1230M06	7311518182168	1	73,22	145
L1230M06X	7311518182175	1	72,80	145
L1630M06	7311518192914	1	76,59	145
L1630M06X	7311518187446	1	80,38	145
L1630M08	7311518182205	1	76,59	145
L1630M08X	7311518136833	1	80,38	145
LAP-KNIFE	7311518216443	10	41,50	635
LARGE	7314150437429	1	2.652,25	375
LS-6160-23	7311518041304	90	8,94	637
LS-COIN 19 CM	7311518031077	4	29,31	601
LS-COIN 26 CM	7311518333041	2	31,49	601
LS-COMBINESS	7311518041366	600	12,94	636
LS-MASSE-4	7311518012014	2	46,54	600
LS-MASSE-4FG	7311518275891	2	57,46	600
LS-MASSE-TR-4FG	7311518281106	2	63,18	601
LS-MERLIN-2.5	7311518012069	2	49,31	601
LS-MERLIN-2.5FG	7311518281113	2	63,65	601
LS-PIERRE CORINDON	7311518009977	1	15,43	636
LS-PIERRE-FAUX	7311518009038	90	16,39	637
LT-STEEL-30	7314150138012	5	67,31	539
LT-STEEL-50	7314150138029	5	105,38	539
LTB-10	7314150120048	6	19,94	539
LTB-20	7314150120062	6	22,62	539
LTB-30	7314150120086	6	29,24	539
LTG-10	7314150119981	6	16,70	539
LTG-20	7314150120000	6	22,38	539
LTG-30	7314150120024	6	26,83	539
LTS-100	7314150120147	5	82,18	539
LTS-100-E	7314150120154	5	82,18	539
LTS-30	7314150120109	5	28,27	539
LTS-30-E	7314150120116	5	28,27	539
LTS-50	7314150120123	5	38,96	539
LTS-50-E	7314150120130	5	38,96	539
LUB-2015	7311518335427	6	19,96	637
M0310M03	7311518036805	1	19,78	145
M0310M03X	7311518197063	1	19,76	145
M0613M03X	7311518196622	1	30,25	145
M0618M06	7311518036836	1	34,67	145
M0618M06X	7311518036850	1	34,48	145
M1022M06	7311518036881	1	41,91	145
M1022M06X	7311518036904	1	41,74	145
M1227M06	7311518036928	1	53,82	145
M1227M06X	7311518036959	1	53,63	145
M1227M08	7311518036980	1	53,71	145
M1630M06	7311518193010	1	88,91	145
M1630M06X	7311518187453	1	88,51	145
M1630M08	7311518037062	1	88,91	145
M1630M08X	7311518037086	1	88,51	145
M227L	7311518160883	4	36,92	577
M227R	7311518160869	4	36,92	578
M330	7311518160906	4	72,01	578
M526	7311518160982	4	37,32	578
M6376	7311518196486	1	293,24	578
M6376-SH	7311518199296	1	125,67	578
M676	7311518161088	1	283,73	578
M676-SH	7311518211875	1	125,44	578



M780	7314151826215	1	20,42	219
M781	7314153016218	5	12,91	219
M926	7311518161071	1	82,93	579
M926-SH	7314150107537	1	18,33	579
MA225	7311518161057	4	48,99	576
MA225L	7311518161033	4	51,01	576
MA225R	7311518161040	4	51,01	576
MA311	7314150181568	1	38,66	576
MA321	7314150181551	10	38,66	576
MA325	7311518161064	4	58,76	577
MA351	7314150181582	10	43,30	577
MA361	7314150181575	10	43,30	577
MA401	7314150167593	10	29,61	576
MA411	7314150167609	10	29,61	576
MA421	7314150167616	10	29,61	576
MA431	7314150181544	1	32,48	576
MA500-1A	7314150458882	1	273,26	654
MA500-2A	7314150458899	1	279,60	654
MA500-3A	7314150456925	1	285,74	654
MAM50M	7314150215300	1	248,76	115
MCP-2.5-810	7311518124052	2	73,40	600
MES-3.0-900	7311518123864	2	53,78	601
MES-3.5-900	7311518123871	2	59,98	601
MES-3.5-900FG	7311518281120	2	77,08	601
MK5	7314150224333	1	27,48	59
MK9	7314150224326	1	41,89	60
MONSTER	7314150437405	1	8.249,56	375
MR227L	7311518161002	4	45,96	578
MR227R	7311518160999	4	45,55	578
MR340	7311518197537	2	92,78	577
MT-TS-3	7314150194995	12	9,85	538
MTB-3-16	7314150119066	6	11,76	538
MTB-3-16-M	7314150119073	6	13,41	538
MTB-3-16-M-E	7314150119141	6	13,41	538
MTB-5-25	7314150119080	6	24,03	538
MTB-5-25-C1	7314150119127	6	35,59	538
MTB-5-25-M	7314150119097	6	25,71	538
MTB-5-25-M-E	7314150119158	6	25,71	538
MTB-8-25	7314150125418	6	36,58	538
MTB-8-25-M	7314150127078	6	39,01	538
MTB-8-25-M-E	7314150127085	6	39,01	538
MTC-3-13	7314150321322	6	8,15	538
MTC-3-13-C1	7314150330843	6	11,34	538
MTC-5-16	7314150321339	6	9,93	538
MTC-5-16-C1	7314150330850	6	12,71	538
MTG-3-16	7314150118984	12	5,26	538
MTG-3-16-E	7314150119028	12	5,26	538
MTG-5-19	7314150118991	12	8,28	538
MTG-5-19-E	7314150119035	12	8,28	538
MTG-8-25	7314150330348	4	10,53	538
MTG-8-25-E	7314150390809	4	10,53	538
MTS-5-25	7314150119233	6	32,49	538
MTS-5-25-E	7314150119271	6	32,49	538
MTS-8-25	7314150119257	6	40,13	538
MTS-8-25-E	7314150119295	6	40,13	538
MTT051	7314150270521	6	25,13	586
MTT121	7314150213290	8	20,51	586
MTT151	7314150120703	6	42,10	586
MW-150	7314150125685	2	76,06	539
MW-250	7314150125678	2	136,43	539
N0306M03	7311518182212	1	19,03	145
N0306M03E	7311518182229	1	20,81	145
N0607M06	7311518182236	1	29,71	145
N1213M06	7311518134570	1	47,47	145
N1213M06X	7311518237172	1	47,26	145
N1613M06	7311518136000	1	62,02	145
N1613M06X	7311518204525	1	61,75	145
N1613M08	7311518182267	1	62,02	145
NP-12-COM	7311518264277	4	15,41	560
NP-12-TEN	7311518263959	10	18,09	564
NP-12-VEN	7311518264260	10	18,92	564
NP-16-U7/8-HP	7311518241773	4	14,52	561
NP-19-U7/8-HP	7311518241452	10	14,52	561
NP-22-F7/8-HP	7311518035204	10	15,83	562
NP-22-U7/8-HP	7311518034399	10	15,51	561
NS001-150	7314150316069	5	104,53	506
NS001-200	7314150316076	5	119,66	506
NS001-250	7314150316083	5	160,91	506
NS001-300	7314150316090	5	204,94	506
NS001-375	7314150325108	5	316,33	506
NS001-450	7314150325115	3	440,13	506
NS001-600	7314150325122	1	715,21	506
NS001-900	7314150325139	1	1.608,05	506
NS002-10	7314150284719	10	35,62	506
NS002-11	7314150292592	5	44,65	506
NS002-12	7314150292608	5	44,65	506
NS002-13	7314150284726	10	44,65	506
NS002-14	7314150284733	5	47,29	506
NS002-15	7314150292615	5	49,92	506
NS002-16	7314150292622	5	52,55	506
NS002-17	7314150284740	10	65,67	506
NS002-18	7314150292639	5	68,30	506
NS002-19	7314150284757	10	70,92	506
NS002-20	7314150292646	5	73,56	506
NS002-21	7314150292653	5	76,18	506
NS002-22	7314150292660	10	78,80	506



NS002-23	7314150292677	5	84,07	506
NS002-24	7314150292684	10	89,33	506
NS002-25	7314150292691	5	91,94	506
NS002-26	7314150292707	5	105,09	506
NS002-27	7314150284764	5	105,09	506
NS002-28	7314150292714	5	113,61	506
NS002-29	7314150292721	10	116,25	506
NS002-30	7314150292738	10	124,77	506
NS002-31	7314150292745	5	131,36	506
NS002-32	7314150284771	5	137,91	506
NS002-33	7314150292752	5	150,46	506
NS002-34	7314150292769	5	154,18	506
NS002-35	7314150292776	5	157,62	506
NS002-36	7314150284788	5	164,19	506
NS002-38	7314150292783	5	170,75	506
NS002-40	7314150292790	5	183,89	506
NS002-41	7314150292806	5	210,15	506
NS002-42	7314150292813	5	223,30	506
NS002-46	7314150292820	5	236,44	506
NS002-50	7314150292837	5	302,10	506
NS002-52	7314150292844	5	304,75	506
NS002-55	7314150292851	5	309,06	506
NS002-6	7314150292554	5	34,97	506
NS002-60	7314150292868	1	343,49	506
NS002-65	7314150292875	1	435,97	506
NS002-7	7314150292561	5	39,64	506
NS002-70	7314150292882	1	502,04	506
NS002-75	7314150292899	1	581,29	506
NS002-8	7314150292578	5	39,64	506
NS002-80	7314150292905	1	686,98	506
NS002-9	7314150292585	5	40,96	506
NS003-11	7314150306602	1	37,51	506
NS003-12	7314150306619	1	38,63	506
NS003-14	7314150306626	1	40,60	506
NS003-16	7314150306633	1	45,56	506
NS003-18	7314150320356	1	49,52	506
NS003-20	7314150320363	1	54,10	506
NS003-24	7314150320370	1	68,73	506
NS003-28	7314150320387	1	76,76	506
NS003-30	7314150320394	1	95,43	506
NS003-8	7314150320349	1	32,49	506
NS006-0607	7314150292912	1	17,98	507
NS006-0608	7314150292929	1	18,31	507
NS006-0708	7314150292936	1	17,99	507
NS006-0709	7314150292943	1	18,29	507
NS006-0809	7314150292967	1	17,99	507
NS006-0810	7314150292950	1	19,04	507
NS006-0910	7314150292974	1	19,37	507
NS006-0911	7314150292981	1	23,28	507
NS006-1011	7314150292998	1	22,59	507
NS006-1012	7314150293001	1	25,39	507
NS006-1013	7314150293018	1	25,82	507
NS006-1014	7314150293025	1	26,03	507
NS006-1113	7314150293032	1	29,63	507
NS006-1114	7314150293049	1	30,12	507
NS006-1213	7314150293056	1	28,24	507
NS006-1214	7314150293063	1	38,57	507
NS006-1315	7314150293070	1	42,32	507
NS006-1415	7314150293087	1	33,89	507
NS006-1416	7314150293094	1	42,32	507
NS006-1417	7314150293100	1	33,89	507
NS006-1617	7314150293117	1	36,70	507
NS006-1618	7314150293124	1	36,70	507
NS006-1719	7314150293131	1	36,70	507
NS006-1722	7314150293148	1	42,36	507
NS006-1819	7314150293155	1	42,36	507
NS006-1820	7314150293162	1	45,00	507
NS006-1920	7314150293179	1	45,18	507
NS006-1922	7314150293186	1	50,83	507
NS006-1924	7314150293193	1	50,83	507
NS006-2022	7314150293209	1	50,83	507
NS006-2122	7314150293216	1	51,25	507
NS006-2123	7314150293223	1	53,64	507
NS006-2223	7314150293230	1	56,48	507
NS006-2224	7314150293247	1	56,94	507
NS006-2227	7314150293254	1	63,53	507
NS006-2326	7314150293261	1	64,63	507
NS006-2425	7314150293278	1	69,40	507
NS006-2426	7314150293285	1	70,60	507
NS006-2427	7314150293292	1	49,92	507
NS006-2430	7314150293308	1	56,44	507
NS006-2528	7314150293315	1	52,55	507
NS006-2629	7314150293322	1	53,91	507
NS006-2729	7314150293339	1	60,42	507
NS006-2730	7314150293346	1	75,35	507
NS006-2732	7314150293353	1	84,40	507
NS006-2830	7314150293360	1	84,40	507
NS006-3031	7314150293377	1	87,41	507
NS006-3032	7314150293384	1	105,88	507
NS006-3034	7314150293391	1	92,83	507
NS006-3036	7314150293407	1	92,83	507
NS006-3234	7314150293414	1	92,83	507
NS006-3235	7314150293421	1	92,83	507
NS006-3236	7314150293438	1	134,11	507
NS006-3335	7314150293445	1	141,13	507
NS006-3436	7314150293452	1	141,13	507



NS006-3536	7314150293469	1	141,13	507
NS006-3638	7314150293476	1	206,20	507
NS006-3641	7314150293483	1	206,20	507
NS006-3642	7314150293490	1	229,11	507
NS006-4146	7314150293506	1	211,77	507
NS006-4650	7314150293513	1	297,85	507
NS006-5052	7314150293520	1	302,43	507
NS006-5055	7314150293537	1	307,01	507
NS006-5060	7314150293544	1	311,59	507
NS006-5062	7314150293551	1	423,53	507
NS006-5560	7314150293568	1	451,76	507
NS006-6065	7314150293575	1	550,59	507
NS006-6570	7314150293582	1	564,71	507
NS010-0607	7314150293599	1	35,45	508
NS010-0709	7314150293605	1	35,45	508
NS010-0809	7314150293612	1	37,62	508
NS010-0911	7314150293629	1	39,80	508
NS010-1011	7314150293636	1	39,80	508
NS010-1012	7314150293643	1	41,34	508
NS010-1214	7314150293650	1	42,91	508
NS010-1315	7314150293667	1	50,99	508
NS010-1417	7314150293674	1	50,99	508
NS010-1618	7314150293681	1	67,77	508
NS010-1719	7314150293698	1	74,61	508
NS010-1722	7314150293704	1	82,07	508
NS010-1819	7314150293711	1	74,61	508
NS010-1921	7314150293728	1	90,77	508
NS010-1922	7314150293735	1	92,93	508
NS010-2022	7314150293742	1	95,12	508
NS010-2123	7314150293759	1	102,59	508
NS010-2224	7314150293766	1	111,91	508
NS010-2427	7314150293773	1	131,80	508
NS010-2528	7314150293780	1	147,36	508
NS010-2628	7314150293797	1	150,38	508
NS010-2730	7314150293803	1	153,42	508
NS010-2732	7314150293810	1	169,26	508
NS010-3032	7314150293827	1	179,68	508
NS010-3036	7314150293834	1	224,58	508
NS010-3236	7314150293841	1	269,51	508
NS010-3641	7314150293858	1	404,26	508
NS010-4146	7314150293865	1	440,77	508
NS010-4650	7314150293872	1	468,31	508
NS011-0607	7314150317271	1	24,85	508
NS011-0809	7314150317288	1	26,83	508
NS011-1011	7314150317295	1	32,47	508
NS011-1213	7314150317301	1	42,36	508
NS011-1415	7314150317318	1	48,01	508
NS011-1617	7314150317325	1	52,24	508
NS011-1819	7314150317332	1	64,94	508
NS011-2022	7314150317349	1	76,22	508
NS011-2123	7314150317356	1	79,08	508
NS011-2426	7314150317363	1	96,83	508
NS011-2528	7314150317370	1	96,83	508
NS011-2729	7314150317387	1	106,62	508
NS011-3032	7314150317394	1	130,56	508
NS041-12-50	7314150502547	1	2.040,81	524
NS041-16-100	7314150502561	1	2.320,37	524
NS041-16-200	7314150502332	1	2.523,90	524
NS041-16-260	7314150502585	1	2.722,94	524
NS041-24-670	7314150502608	1	8.092,78	524
NS041-32-900	7314150502622	1	9.192,02	524
NS041-8-25	7314150502646	1	1.516,07	524
NS100-100	7314150294305	1	1.300,30	509
NS100-105	7314150294312	1	1.581,89	509
NS100-110	7314150294329	1	1.400,91	509
NS100-115	7314150294336	1	1.678,68	509
NS100-120	7314150294343	1	1.795,53	509
NS100-17	7314150293889	1	77,16	508
NS100-19	7314150293896	1	80,23	508
NS100-22	7314150293902	1	83,33	508
NS100-24	7314150293919	1	89,49	508
NS100-25	7314150293926	1	100,32	508
NS100-27	7314150293933	1	101,25	508
NS100-28	7314150293940	1	102,22	508
NS100-29	7314150293957	1	104,92	508
NS100-30	7314150293964	1	105,92	508
NS100-32	7314150293971	1	111,49	508
NS100-33	7314150293988	1	118,05	508
NS100-34	7314150293995	1	140,21	508
NS100-35	7314150294008	1	146,60	508
NS100-36	7314150294015	1	148,00	508
NS100-37	7314150294022	1	162,03	508
NS100-38	7314150294039	1	163,56	508
NS100-41	7314150294046	1	177,45	508
NS100-42	7314150294053	1	207,96	508
NS100-45	7314150294060	1	223,76	509
NS100-46	7314150294077	1	225,89	509
NS100-47	7314150294084	1	243,05	509
NS100-50	7314150294091	1	262,33	509
NS100-52	7314150294107	1	288,57	509
NS100-54	7314150294114	1	300,92	509
NS100-55	7314150294121	1	300,92	509
NS100-56	7314150294138	1	315,24	509
NS100-58	7314150294145	1	378,05	509
NS100-60	7314150294152	1	381,66	509
NS100-63	7314150294169	1	404,92	509



NS100-65



NS100-65	7314150294176	1	416,64	509
NS100-67	7314150294183	1	495,99	509
NS100-70	7314150294190	1	547,81	509
NS100-71	7314150294206	1	573,90	509
NS100-75	7314150294213	1	616,88	509
NS100-77	7314150294220	1	688,70	509
NS100-80	7314150294237	1	727,46	509
NS100-82	7314150294244	1	797,72	509
NS100-85	7314150294251	1	828,87	509
NS100-88	7314150294268	1	939,09	509
NS100-90	7314150294275	1	847,06	509
NS100-94	7314150294282	1	868,40	509
NS100-95	7314150294299	1	847,06	509
NS104-100	7314150294947	1	788,11	509
NS104-105	7314150294954	1	853,79	509
NS104-110	7314150294961	1	1.011,42	509
NS104-115	7314150294978	1	1.011,42	509
NS104-120	7314150294985	1	1.313,51	509
NS104-17	7314150294350	1	84,08	509
NS104-19	7314150294367	1	85,62	509
NS104-20	7314150294374	1	86,37	509
NS104-22	7314150294381	1	87,14	509
NS104-24	7314150284795	1	88,68	509
NS104-25	7314150294398	1	99,67	509
NS104-26	7314150294404	1	99,72	509
NS104-27	7314150284801	1	99,72	509
NS104-28	7314150294411	1	104,62	509
NS104-29	7314150294428	1	106,95	509
NS104-30	7314150284818	1	111,10	509
NS104-31	7314150294435	1	114,64	509
NS104-32	7314150284825	1	116,54	509
NS104-33	7314150294442	1	127,87	509
NS104-34	7314150294459	1	135,22	509
NS104-35	7314150294466	1	138,75	509
NS104-36	7314150284832	1	136,00	509
NS104-37	7314150294473	1	136,63	509
NS104-38	7314150294480	1	142,40	509
NS104-39	7314150294497	1	172,15	509
NS104-40	7314150294503	1	175,39	509
NS104-41	7314150284849	1	178,31	509
NS104-42	7314150294510	1	193,92	509
NS104-43	7314150294527	1	198,98	509
NS104-44	7314150294534	1	193,92	509
NS104-45	7314150294541	1	197,30	509
NS104-46	7314150284856	1	202,36	509
NS104-47	7314150294558	1	219,07	509
NS104-48	7314150294565	1	222,88	509
NS104-49	7314150294572	1	226,70	509
NS104-50	7314150284863	1	230,50	509
NS104-51	7314150294589	1	236,24	509
NS104-52	7314150294596	1	242,04	509
NS104-53	7314150294602	1	243,97	509
NS104-54	7314150294619	1	245,91	509
NS104-55	7314150284870	1	262,69	509
NS104-56	7314150294626	1	269,82	509
NS104-57	7314150294633	1	274,33	509
NS104-58	7314150294640	1	278,82	509
NS104-59	7314150294657	1	283,32	509
NS104-60	7314150284887	1	308,67	509
NS104-61	7314150294664	1	319,64	509
NS104-62	7314150294671	1	326,08	509
NS104-63	7314150294688	1	336,30	509
NS104-64	7314150294695	1	346,47	509
NS104-65	7314150294701	1	337,02	509
NS104-66	7314150294718	1	327,91	509
NS104-67	7314150294725	1	333,17	509
NS104-68	7314150294732	1	402,24	509
NS104-69	7314150294749	1	402,24	509
NS104-70	7314150284894	1	380,90	509
NS104-71	7314150294756	1	405,11	509
NS104-72	7314150294763	1	407,99	509
NS104-73	7314150294770	1	410,85	509
NS104-74	7314150294787	1	413,73	509
NS104-75	7314150284900	1	459,72	509
NS104-76	7314150294794	1	478,15	509
NS104-77	7314150294800	1	484,12	509
NS104-78	7314150294817	1	498,24	509
NS104-79	7314150294824	1	512,39	509
NS104-80	7314150284917	1	526,53	509
NS104-81	7314150294831	1	555,99	509
NS104-82	7314150294848	1	562,55	509
NS104-83	7314150294855	1	569,12	509
NS104-84	7314150294862	1	575,68	509
NS104-85	7314150284924	1	582,25	509
NS104-86	7314150294879	1	644,98	509
NS104-87	7314150294886	1	659,19	509
NS104-88	7314150294893	1	673,39	509
NS104-89	7314150294909	1	687,61	509
NS104-90	7314150284931	1	647,85	509
NS104-92	7314150294916	1	738,05	509
NS104-94	7314150294923	1	747,26	509
NS104-95	7314150284948	1	669,92	509
NS104-98	7314150294930	1	794,85	509
NS106-100	7314150295418	1	634,88	510
NS106-104	7314150295425	1	652,51	510
NS106-108	7314150295432	1	668,82	510



NS106-112	7314150295449	1	692,18	510
NS106-114	7314150295456	1	731,87	510
NS106-116	7314150295463	1	828,20	510
NS106-120	7314150295470	1	863,55	510
NS106-124	7314150295487	1	932,62	510
NS106-126	7314150295494	1	1.007,22	510
NS106-128	7314150295500	1	1.047,52	510
NS106-132	7314150295517	1	1.087,81	510
NS106-136	7314150295524	1	1.265,21	510
NS106-138	7314150295531	1	1.296,82	510
NS106-144	7314150295548	1	1.547,52	510
NS106-146	7314150295555	1	1.566,62	510
NS106-150	7314150295562	1	1.661,61	510
NS106-156	7314150295579	1	1.857,11	510
NS106-158	7314150295586	1	2.657,99	510
NS106-20	7314150294992	1	60,62	510
NS106-22	7314150295005	1	76,94	510
NS106-24	7314150295012	1	81,07	510
NS106-25	7314150295029	1	86,85	510
NS106-26	7314150295036	1	88,41	510
NS106-28	7314150295043	1	91,25	510
NS106-30	7314150295050	1	92,79	510
NS106-32	7314150295067	1	94,30	510
NS106-34	7314150295074	1	97,34	510
NS106-36	7314150295081	1	100,39	510
NS106-38	7314150295098	1	103,30	510
NS106-40	7314150295104	1	105,09	510
NS106-42	7314150295111	1	97,59	510
NS106-44	7314150295128	1	100,13	510
NS106-45	7314150295135	1	102,47	510
NS106-46	7314150295142	1	133,91	510
NS106-48	7314150295159	1	135,90	510
NS106-50	7314150295166	1	141,36	510
NS106-52	7314150295173	1	171,13	510
NS106-54	7314150295180	1	154,78	510
NS106-56	7314150295197	1	158,55	510
NS106-58	7314150295203	1	197,01	510
NS106-60	7314150295210	1	215,12	510
NS106-62	7314150295227	1	195,96	510
NS106-64	7314150295234	1	229,10	510
NS106-66	7314150295241	1	214,47	510
NS106-68	7314150295258	1	226,82	510
NS106-70	7314150295265	1	239,20	510
NS106-71	7314150295272	1	239,20	510
NS106-72	7314150295289	1	280,77	510
NS106-74	7314150295296	1	295,54	510
NS106-76	7314150295302	1	302,10	510
NS106-78	7314150295319	1	286,45	510
NS106-80	7314150295326	1	315,25	510
NS106-82	7314150295333	1	316,03	510
NS106-84	7314150295340	1	328,37	510
NS106-88	7314150295357	1	394,04	510
NS106-90	7314150295364	1	405,60	510
NS106-92	7314150295371	1	423,23	510
NS106-94	7314150295388	1	446,59	510
NS106-96	7314150295395	1	472,86	510
NS106-98	7314150295401	1	462,94	510
NS200-1200	7314150295661	1	1.715,14	511
NS200-200	7314150295593	1	196,47	511
NS200-250	7314150295609	1	228,15	511
NS200-300	7314150295616	1	247,18	511
NS200-350	7314150295623	1	291,53	511
NS200-450	7314150295630	1	493,78	511
NS200-600	7314150295647	1	728,33	511
NS200-900	7314150295654	1	1.255,20	511
NS202-350	7314150299690	1	255,96	511
NS203-200	7314150359509	1	85,70	511
NS203-215	7314150359516	1	128,48	511
NS203-290	7314150359523	1	139,82	511
NS203-400	7314150359530	1	183,74	511
NS203-490	7314150359547	1	273,19	511
NS203-800	7314150359554	1	647,86	511
NS204-30	7314150295685	1	149,30	511
NS204-32	7314150295692	1	203,18	511
NS204-35	7314150295708	1	168,20	511
NS204-40	7314150295715	1	203,18	511
NS204-45	7314150295722	1	223,95	511
NS204-48	7314150295739	1	246,63	511
NS204-50	7314150295746	1	260,79	511
NS204-55	7314150295753	1	271,19	511
NS204-60	7314150295760	1	289,15	511
NS204-65	7314150295777	1	324,12	511
NS204-70	7314150295784	1	362,86	511
NS204-75	7314150295791	1	405,39	511
NS204-80	7314150295807	1	463,03	511
NS204-85	7314150295814	1	521,61	511
NS204-90	7314150295821	1	548,08	511
NS220-06	7314150347216	1	63,35	512
NS220-07	7314150347223	1	64,94	512
NS220-08	7314150347230	1	66,52	512
NS220-09	7314150347247	1	68,10	512
NS220-10	7314150347254	1	69,70	512
NS220-11	7314150347261	1	71,26	512
NS220-12	7314150347278	1	72,86	512
NS220-13	7314150347285	1	74,45	512
NS220-14	7314150347292	1	76,04	512



NS220-15	7314150347308	1	77,61	512
NS220-16	7314150347315	1	79,20	512
NS220-17	7314150347322	1	85,53	512
NS220-18	7314150347339	1	87,10	512
NS220-19	7314150347346	1	88,69	512
NS220-20	7314150347353	1	90,28	512
NS220-21	7314150347360	1	95,04	512
NS220-22	7314150347377	1	98,20	512
NS220-23	7314150347384	1	101,37	512
NS220-24	7314150347391	1	107,69	512
NS220-25	7314150347407	1	110,87	512
NS220-26	7314150347414	1	118,79	512
NS220-27	7314150347421	1	123,55	512
NS220-28	7314150347438	1	126,71	512
NS220-29	7314150347445	1	138,24	512
NS220-30	7314150347452	1	139,38	512
NS220-32	7314150347469	1	142,55	512
NS220-34	7314150347476	1	123,41	512
NS220-36	7314150347483	1	135,75	512
NS220-41	7314150347490	1	164,99	512
NS224-17	7314150355525	1	86,88	512
NS224-18	7314150355532	1	87,15	512
NS224-19	7314150355549	1	87,42	512
NS224-21	7314150355556	1	96,15	512
NS224-22	7314150355563	1	97,18	512
NS224-23	7314150355570	1	102,66	512
NS224-24	7314150355587	1	128,85	512
NS224-26	7314150355594	1	130,21	512
NS224-27	7314150355617	1	138,14	512
NS224-28	7314150355624	1	145,04	512
NS224-29	7314150355631	1	155,09	512
NS224-30	7314150355648	1	163,55	512
NS224-32	7314150355655	1	184,72	512
NS224-34	7314150355662	1	199,55	512
NS224-36	7314150355679	1	212,77	512
NS224-38	7314150355686	1	227,60	512
NS224-41	7314150355693	1	250,89	512
NS224-46	7314150355709	1	296,39	512
NS224-50	7314150355716	1	324,99	512
NS228-22	7314150355914	1	127,64	513
NS228-24	7314150355921	1	140,95	513
NS228-26	7314150355938	1	174,22	513
NS228-27	7314150355945	1	180,25	513
NS228-28	7314150355952	1	183,89	513
NS228-29	7314150355969	1	188,13	513
NS228-30	7314150355976	1	192,35	513
NS228-31	7314150355983	1	208,09	513
NS228-32	7314150355990	1	222,60	513
NS228-34	7314150356003	1	234,71	513
NS228-36	7314150356010	1	251,65	513
NS228-38	7314150356027	1	270,99	513
NS228-41	7314150356034	1	307,89	513
NS228-46	7314150356041	1	342,38	513
NS228-50	7314150356058	1	376,25	513
NS228-55	7314150356065	1	424,64	513
NS228-60	7314150356072	1	474,24	513
NS228-65	7314150356089	1	526,26	513
NS228-70	7314150356096	1	579,50	513
NS228-75	7314150356102	1	632,73	513
NS228-80	7314150356119	1	687,78	513
NS232-16-24	7314150356331	1	124,02	513
NS232-24-16	7314150356355	1	151,27	513
NS232-24-32	7314150356348	1	253,04	513
NS232-32-24	7314150356362	1	245,70	513
NS234-16-100	7314150356416	1	120,26	513
NS234-16-200	7314150356423	1	132,06	513
NS234-16-250	7314150356430	1	145,04	513
NS234-24-200	7314150356447	1	198,07	513
NS234-32-250	7314150356454	1	341,94	513
NS236-16	7314150356522	1	146,99	513
NS236-24	7314150356539	1	354,77	513
NS236-32	7314150356515	1	484,52	513
NS238-16-250	7314150356577	1	206,35	514
NS238-24-250	7314150356584	1	409,14	514
NS238-32-300	7314150356591	1	514,09	514
NS240-16-230	7314150356737	1	189,92	514
NS242-16	7314150356638	1	308,92	514
NS242-24	7314150356645	1	496,40	514
NS242-32	7314150356652	1	962,92	514
NS243-16-400	7314150356690	1	241,91	514
NS247-26	7314150356751	1	146,32	515
NS248-16-52	7314150356713	1	78,33	515
NS300-10-200	7314150317783	1	71,51	515
NS300-10-300	7314150316205	1	93,25	515
NS300-11-250	7314150317790	1	85,48	515
NS300-11-300	7314150317806	1	101,02	515
NS300-11-350	7314150316212	1	116,56	515
NS300-12-400	7314150325153	1	122,78	515
NS300-13-450	7314150325160	1	132,11	515
NS300-3-50	7314150317677	1	16,94	515
NS300-3-75	7314150317684	1	19,76	515
NS300-4-75	7314150317691	1	21,18	515
NS300-4.5-100	7314150316175	1	25,67	515
NS300-4.5-50	7314150317707	1	18,36	515
NS300-5-100	7314150317721	1	25,40	515
NS300-5-75	7314150317714	1	22,59	515



NS300-6-100	7314150316182	1	26,83	515
NS300-6-125	7314150317738	1	30,39	515
NS300-6-150	7314150317745	1	33,57	515
NS300-7-150	7314150317752	1	38,00	515
NS300-8-150	7314150316199	1	41,34	515
NS300-8-200	7314150317769	1	49,43	515
NS300-9-250	7314150317776	1	56,48	515
NS301-10-200	7314150317882	1	76,18	515
NS301-10-300	7314150317899	1	90,55	515
NS301-3-50	7314150317813	1	21,18	515
NS301-4-100	7314150317820	1	26,83	515
NS301-4-150	7314150317837	1	44,77	515
NS301-5-100	7314150317844	1	41,86	515
NS301-5-200	7314150317851	1	44,86	515
NS301-6-100	7314150317868	1	44,99	515
NS301-8-150	7314150317875	1	60,91	515
NS302-0-50	7314150316229	1	23,99	516
NS302-1-100	7314150316236	1	23,99	516
NS302-2-125	7314150316243	1	30,57	516
NS302-3-150	7314150316250	1	42,36	516
NS302-4-300	7314150316267	1	67,77	516
NS304-0-50	7314150316274	1	23,99	516
NS304-1-100	7314150316281	1	23,99	516
NS304-2-125	7314150316298	1	28,24	516
NS304-3-150	7314150316304	1	42,36	516
NS304-4-300	7314150316311	1	67,77	516
NS320-10	7314150318162	1	47,41	516
NS320-2	7314150318087	1	30,75	516
NS320-3	7314150318094	1	31,12	516
NS320-4	7314150318100	1	31,61	516
NS320-5	7314150318117	1	32,98	516
NS320-6	7314150318124	1	34,39	516
NS320-7	7314150318131	1	38,08	516
NS320-8	7314150318148	1	39,95	516
NS320-9	7314150318155	1	44,15	516
NS400-160	7314150316106	1	127,05	516
NS400-180	7314150316113	1	141,17	516
NS400-200	7314150316120	1	155,30	516
NS402-160	7314150316137	1	165,00	517
NS402-200	7314150325177	1	169,41	517
NS403-160	7314150318209	1	155,30	517
NS403-180	7314150318193	1	169,41	517
NS404-160	7314150318216	1	119,99	517
NS405-160	7314150318247	1	119,99	517
NS406-160	7314150316144	1	127,05	517
NS406-180	7314150318261	1	152,13	517
NS406-200	7314150316151	1	152,88	517
NS407-160	7314150318278	1	276,95	517
NS408-250	7314150316168	1	191,24	518
NS408-300	7314150318292	1	231,59	518
NS411-200	7314150318322	1	183,53	518
NS412-200	7314150318339	1	112,93	518
NS413-180	7314150318384	1	286,08	518
NS413-200	7314150318377	1	286,08	518
NS500-1000-FB	7314150296019	1	155,44	519
NS500-1500-FB	7314150296026	1	179,24	519
NS500-2000	7314150291847	1	271,58	519
NS500-2000-FB	7314150284955	1	219,47	519
NS500-2500	7314150291854	1	339,38	519
NS500-2500-FB	7314150284962	1	275,28	519
NS500-3000	7314150291861	1	407,18	519
NS500-3000-FB	7314150284979	1	310,59	519
NS500-3500-FB	7314150284986	1	438,92	519
NS500-4000	7314150291878	1	539,76	519
NS502-1000-FB	7314150284993	1	118,81	519
NS502-10000-FB	7314150285068	1	919,47	519
NS502-12000-FB	7314150318407	1	1.050,82	519
NS502-1500-FB	7314150318438	1	157,62	519
NS502-2000-FB	7314150285006	1	192,19	519
NS502-2500-FB	7314150285013	1	244,61	519
NS502-3000-FB	7314150285020	1	297,02	519
NS502-450-FB	7314150296033	1	88,33	519
NS502-4500-FB	7314150285037	1	354,65	519
NS502-5000-FB	7314150285044	1	420,32	519
NS502-6800-FB	7314150318445	1	551,68	519
NS502-8000-FB	7314150285051	1	660,00	519
NS504-100-FB	7314150296040	1	56,48	519
NS504-1000-FB	7314150285099	1	155,44	519
NS504-1500-FB	7314150285105	1	183,53	519
NS504-200-FB	7314150296057	1	60,00	519
NS504-2000-FB	7314150285112	1	225,87	519
NS504-300-FB	7314150296064	1	64,94	519
NS504-500-FB	7314150285075	1	88,94	519
NS504-800-FB	7314150285082	1	117,16	519
NS506-300	7314150285129	1	54,86	519
NS506-300-FB	7314150318469	1	55,70	520
NS506-450	7314150285136	1	73,15	519
NS506-450-FB	7314150318476	1	74,26	520
NS506-700	7314150296071	1	102,88	519
NS506-700-FB	7314150285143	1	94,06	520
NS506-900	7314150296088	1	137,15	519
NS506-900-FB	7314150285150	1	143,13	520
NS508-500-FB	7314150318544	1	88,75	520
NS508-700-FB	7314150318537	1	104,88	520
NS512-200-FB	7314150318568	1	75,83	520
NS512-400-FB	7314150318575	1	95,20	520





NS512-600-FB	7314150318582	1	104,88	520
NS512-900-FB	7314150318599	1	127,46	520
NS600-100-50	7314150296101	1	36,57	520
NS600-135-50	7314150296118	1	69,50	520
NS600-150-25	7314150296125	1	32,92	520
NS600-150-30	7314150301676	1	29,28	520
NS600-150-40	7314150296132	1	36,57	520
NS600-150-50	7314150296149	1	62,18	520
NS600-180-13	7314150296156	1	29,28	520
NS600-180-32	7314150296167	1	42,06	520
NS600-180-50	7314150285174	1	93,27	520
NS600-200-20	7314150296163	1	82,30	520
NS600-200-30	7314150296170	1	100,58	520
NS600-200-40	7314150296187	1	147,65	520
NS600-200-50	7314150301782	1	72,46	520
NS600-230-40	7314150296194	1	106,08	520
NS600-250-40	7314150296200	1	164,59	520
NS600-300-50	7314150296217	1	321,88	520
NS600-80-13	7314150296095	1	9,87	520
NS602-460	7314150285181	1	148,04	521
NS602-600	7314150285198	1	203,95	521
NS602-760	7314150296224	1	313,26	521
NS602-900	7314150296231	1	364,01	521
NS604-150	7314150296248	1	101,08	521
NS604-200	7314150285204	1	162,15	521
NS604-300	7314150285211	1	265,23	521
NS606-150	7314150285228	1	55,26	521
NS606-200	7314150285235	1	71,05	521
NS606-250	7314150285242	1	96,05	521
NS606-300	7314150285259	1	114,45	521
NS606-400	7314150285266	1	147,37	521
NS608-100	7314150285273	1	33,84	521
NS700-300	7314150325184	1	63,47	521
NS702-200	7314150325191	1	54,20	522
NS704-225	7314150325207	1	120,63	522
NS706-50	7314150325214	1	76,30	522
NS706-80	7314150325221	1	117,09	522
NS708-360	7314150325238	1	163,88	522
NS710-450	7314150325245	1	348,50	523
NS800-1100	7314150296323	1	167,93	523
NS800-1700	7314150285280	1	245,50	523
NS800-2000	7314150296330	1	292,94	523
NS802-290	7314150285297	1	223,13	523
NS804-290	7314150296347	1	49,81	523
NS810-100	7314150318728	1	1.059,01	523
NS810-150	7314150318711	1	1.175,67	523
NS810-200	7314150318704	1	1.256,16	523
NS810-350	7314150318698	1	1.882,02	523
NSB001-150	7314150292509	5	148,54	506
NSB001-200	7314150284689	5	185,67	506
NSB001-250	7314150284696	5	247,58	506
NSB001-300	7314150284702	5	275,08	506
NSB001-375	7314150292516	5	417,45	506
NSB001-450	7314150292523	3	567,02	506
NSB001-600	7314150292530	3	1.046,88	506
NSB001-900	7314150292547	1	2.343,32	506
NSB002-10	7314150316366	5	48,60	506
NSB002-11	7314150316373	5	52,55	506
NSB002-12	7314150316380	5	57,80	506
NSB002-13	7314150316397	5	60,42	506
NSB002-14	7314150316403	5	63,05	506
NSB002-15	7314150316410	5	72,12	506
NSB002-16	7314150316427	5	74,88	506
NSB002-17	7314150316434	5	85,37	506
NSB002-18	7314150316441	5	89,33	506
NSB002-19	7314150316458	5	91,94	506
NSB002-20	7314150316465	5	94,57	506
NSB002-21	7314150316472	5	102,47	506
NSB002-22	7314150316489	5	105,09	506
NSB002-23	7314150316496	5	110,33	506
NSB002-24	7314150316502	5	124,77	506
NSB002-25	7314150316519	5	131,36	506
NSB002-26	7314150316526	5	137,39	506
NSB002-27	7314150316533	5	140,84	506
NSB002-28	7314150316540	5	173,76	506
NSB002-29	7314150316557	5	177,81	506
NSB002-30	7314150316564	5	191,95	506
NSB002-31	7314150321728	1	232,37	506
NSB002-32	7314150316571	10	242,46	506
NSB002-33	7314150321735	1	244,03	506
NSB002-34	7314150321742	1	249,62	506
NSB002-35	7314150321759	1	252,57	506
NSB002-36	7314150321766	5	272,77	506
NSB002-38	7314150321773	1	292,98	506
NSB002-40	7314150321780	1	321,26	506
NSB002-41	7314150321797	5	345,50	506
NSB002-42	7314150321803	1	363,70	506
NSB002-46	7314150321810	1	402,09	506
NSB002-50	7314150321827	1	444,51	506
NSB002-52	7314150321834	1	460,70	506
NSB002-55	7314150321841	1	484,92	506
NSB002-6	7314150316328	5	60,61	506
NSB002-60	7314150321858	1	525,33	506
NSB002-65	7314150321865	1	666,78	506
NSB002-7	7314150316335	5	60,61	506
NSB002-70	7314150321872	1	767,80	506



NSB002-75	7314150321889	1	889,05	506
NSB002-8	7314150316342	5	60,61	506
NSB002-80	7314150321896	1	1.050,68	506
NSB002-9	7314150316359	5	49,00	506
NSB003-10	7314150342709	1	33,09	506
NSB003-11	7314150342716	1	28,02	506
NSB003-12	7314150342723	5	28,02	506
NSB003-13	7314150342730	1	33,09	507
NSB003-14	7314150342747	1	44,69	507
NSB003-16	7314150342754	5	78,38	507
NSB003-18	7314150342761	1	78,38	507
NSB003-19	7314150342778	1	82,34	507
NSB003-20	7314150342785	1	74,16	507
NSB003-22	7314150342792	5	49,31	507
NSB003-24	7314150342808	5	777,79	507
NSB003-25	7314150342815	1	1.137,58	507
NSB003-26	7314150342822	1	897,77	507
NSB003-28	7314150342839	5	1.415,63	507
NSB003-30	7314150342846	1	1.157,03	507
NSB003-31	7314150342853	1	1.353,28	507
NSB003-32	7314150342860	1	477,92	507
NSB003-34	7314150342877	1	438,56	507
NSB003-36	7314150342884	1	547,60	507
NSB003-38	7314150342891	1	602,70	507
NSB003-40	7314150342907	1	841,41	507
NSB003-42	7314150342914	1	670,60	507
NSB003-44	7314150342921	5	1.045,55	507
NSB003-46	7314150342938	1	51,48	507
NSB003-48	7314150342945	1	53,92	507
NSB003-50	7314150342952	1	109,62	507
NSB003-52	7314150342969	1	339,88	507
NSB003-54	7314150342976	1	349,84	507
NSB003-56	7314150342983	1	5,14	507
NSB003-58	7314150342990	1	5,34	507
NSB003-60	7314150343010	1	6,13	507
NSB003-62	7314150343027	1	6,32	507
NSB003-64	7314150343034	5	50,62	507
NSB003-68	7314150343041	1	111,80	507
NSB003-72	7314150343058	1	131,71	507
NSB003-8	7314150342693	1	1.518,53	506
NSB003-80	7314150343065	1	40,81	507
NSB003-84	7314150343072	1	918,07	507
NSB003-88	7314150343089	1	9,42	507
NSB006-0607	7314150316588	1	22,74	507
NSB006-0608	7314150321926	1	23,16	507
NSB006-0708	7314150321933	1	25,76	507
NSB006-0709	7314150321940	1	26,19	507
NSB006-0809	7314150316595	1	25,78	507
NSB006-0810	7314150321957	1	27,28	507
NSB006-0910	7314150321964	1	27,73	507
NSB006-0911	7314150321971	1	33,34	507
NSB006-1011	7314150316601	1	33,89	507
NSB006-1012	7314150322015	1	36,70	507
NSB006-1013	7314150322022	1	37,32	507
NSB006-1014	7314150322039	1	39,53	507
NSB006-1113	7314150322046	1	45,00	507
NSB006-1114	7314150322053	1	45,75	507
NSB006-1213	7314150316618	1	45,18	507
NSB006-1214	7314150322060	1	45,55	507
NSB006-1315	7314150322077	1	49,98	507
NSB006-1415	7314150316625	1	50,83	507
NSB006-1416	7314150322084	1	59,36	507
NSB006-1417	7314150322091	1	60,85	507
NSB006-1617	7314150316632	1	59,30	507
NSB006-1618	7314150322107	1	59,77	507
NSB006-1719	7314150322114	1	67,96	507
NSB006-1722	7314150322121	1	75,52	507
NSB006-1819	7314150316649	1	76,78	507
NSB006-1820	7314150322138	1	77,41	507
NSB006-1920	7314150322145	1	78,67	507
NSB006-1922	7314150322152	1	79,93	507
NSB006-1924	7314150322169	1	88,26	507
NSB006-2022	7314150316656	1	87,53	507
NSB006-2122	7314150322176	1	88,26	507
NSB006-2123	7314150316663	1	88,97	507
NSB006-2223	7314150322183	1	89,68	507
NSB006-2224	7314150322190	1	90,40	507
NSB006-2227	7314150322206	1	95,50	507
NSB006-2326	7314150322213	1	102,60	507
NSB006-2425	7314150322220	1	104,31	507
NSB006-2426	7314150316670	1	106,01	507
NSB006-2427	7314150322237	1	115,96	507
NSB006-2430	7314150322244	1	117,42	507
NSB006-2528	7314150316687	1	119,37	507
NSB006-2629	7314150322251	1	128,84	507
NSB006-2729	7314150316694	1	128,84	507
NSB006-2730	7314150322336	1	128,84	507
NSB006-2732	7314150322343	1	144,29	507
NSB006-2830	7314150322350	1	144,29	507
NSB006-3031	7314150322367	1	149,45	507
NSB006-3032	7314150316700	1	155,30	507
NSB006-3034	7314150322374	1	164,94	507
NSB006-3036	7314150322381	1	164,94	507
NSB006-3234	7314150322398	1	164,94	507
NSB006-3235	7314150322404	1	164,94	507
NSB006-3236	7314150322411	1	164,94	507



NSB006-3335	7314150322428	1	164,94	507
NSB006-3436	7314150322435	1	164,94	507
NSB006-3536	7314150322442	1	164,94	507
NSB006-3638	7314150322459	1	240,97	507
NSB006-3641	7314150322466	1	240,97	507
NSB006-3642	7314150322473	1	267,75	507
NSB006-4146	7314150322480	1	310,59	507
NSB006-4650	7314150322497	1	381,17	507
NSB006-5052	7314150322503	1	387,05	507
NSB006-5055	7314150322510	1	392,90	507
NSB006-5060	7314150322527	1	398,76	507
NSB006-5062	7314150322534	1	404,63	507
NSB006-5560	7314150322558	1	516,05	507
NSB006-6065	7314150322565	1	539,51	507
NSB006-6570	7314150322572	1	574,69	507
NSB010-0607	7314150322589	1	47,42	508
NSB010-0709	7314150322596	1	47,42	508
NSB010-0809	7314150322602	1	46,45	508
NSB010-0911	7314150322619	1	50,06	508
NSB010-1011	7314150322626	1	50,06	508
NSB010-1012	7314150322633	1	55,48	508
NSB010-1214	7314150322640	1	60,93	508
NSB010-1315	7314150322657	1	72,74	508
NSB010-1417	7314150322664	1	72,74	508
NSB010-1618	7314150322671	1	96,98	508
NSB010-1719	7314150322688	1	106,95	508
NSB010-1722	7314150322695	1	115,31	508
NSB010-1819	7314150322718	1	106,95	508
NSB010-1921	7314150322725	1	117,35	508
NSB010-1922	7314150322732	1	118,25	508
NSB010-2022	7314150322749	1	119,14	508
NSB010-2123	7314150322756	1	127,84	508
NSB010-2224	7314150322763	1	151,79	508
NSB010-2427	7314150322770	1	164,83	508
NSB010-2528	7314150322787	1	183,84	508
NSB010-2628	7314150322794	1	194,48	508
NSB010-2730	7314150322800	1	205,10	508
NSB010-2732	7314150322817	1	212,38	508
NSB010-3032	7314150322824	1	239,20	508
NSB010-3036	7314150322831	1	299,01	508
NSB010-3236	7314150322848	1	358,80	508
NSB010-3641	7314150322855	1	538,19	508
NSB010-4146	7314150322862	1	650,31	508
NSB010-4650	7314150322879	1	731,60	508
NSB011-0607	7314150317400	1	29,65	508
NSB011-0809	7314150317417	1	32,01	508
NSB011-1011	7314150317424	1	40,95	508
NSB011-1213	7314150317431	1	59,30	508
NSB011-1415	7314150317448	1	73,41	508
NSB011-1617	7314150317455	1	84,70	508
NSB011-1819	7314150317462	1	107,29	508
NSB011-2022	7314150317479	1	129,87	508
NSB011-2123	7314150317486	1	135,52	508
NSB011-2426	7314150317493	1	167,51	508
NSB011-2528	7314150317509	1	168,02	508
NSB011-2729	7314150317516	1	182,12	508
NSB011-3032	7314150317523	1	225,87	508
NSB041-12-50	7314150502660	1	2.979,02	524
NSB041-16-100	7314150502684	1	3.444,21	524
NSB041-16-200	7314150502318	1	3.693,59	524
NSB041-16-260	7314150502707	1	3.942,95	524
NSB041-24-670	7314150502721	1	12.254,91	524
NSB041-32-900	7314150502745	1	14.454,50	524
NSB041-8-25	7314150502769	1	2.607,76	524
NSB100-100	7314150323302	1	1.552,87	509
NSB100-105	7314150323319	1	1.835,21	509
NSB100-110	7314150323326	1	1.976,44	509
NSB100-115	7314150323333	1	2.368,29	509
NSB100-120	7314150323340	1	2.533,18	509
NSB100-17	7314150322886	1	101,02	509
NSB100-19	7314150322893	1	105,08	509
NSB100-22	7314150322909	1	109,12	509
NSB100-24	7314150322916	1	117,21	509
NSB100-25	7314150322923	1	131,33	509
NSB100-27	7314150322930	1	131,33	509
NSB100-28	7314150322947	1	131,33	509
NSB100-29	7314150322954	1	161,64	509
NSB100-30	7314150322961	1	161,64	509
NSB100-32	7314150322978	1	163,00	509
NSB100-33	7314150322985	1	181,86	509
NSB100-34	7314150322992	1	181,86	509
NSB100-35	7314150323005	1	191,95	509
NSB100-36	7314150323012	1	191,95	509
NSB100-37	7314150323029	1	212,16	509
NSB100-38	7314150323036	1	212,16	509
NSB100-41	7314150323043	1	232,37	509
NSB100-42	7314150323050	1	267,21	509
NSB100-45	7314150323067	1	292,98	509
NSB100-46	7314150323074	1	292,98	509
NSB100-47	7314150323081	1	318,22	509
NSB100-50	7314150323098	1	343,50	509
NSB100-52	7314150323104	1	377,84	509
NSB100-54	7314150323111	1	394,01	509
NSB100-55	7314150323128	1	394,01	509
NSB100-56	7314150323135	1	409,82	509
NSB100-58	7314150323142	1	491,47	509



NSB100-60	7314150323159	1	496,18	509
NSB100-63	7314150323166	1	526,40	509
NSB100-65	7314150323173	1	541,63	509
NSB100-67	7314150323180	1	644,79	509
NSB100-70	7314150323197	1	712,15	509
NSB100-71	7314150323203	1	746,07	509
NSB100-75	7314150323210	1	801,95	509
NSB100-77	7314150323227	1	895,31	509
NSB100-80	7314150323234	1	945,69	509
NSB100-82	7314150323241	1	1.037,01	509
NSB100-85	7314150323258	1	1.077,52	509
NSB100-88	7314150323265	1	1.220,81	509
NSB100-90	7314150323272	1	1.364,10	509
NSB100-94	7314150323289	1	1.398,51	509
NSB100-95	7314150323296	1	1.433,46	509
NSB104-100	7314150316885	1	1.239,35	510
NSB104-105	7314150316892	1	1.315,39	510
NSB104-110	7314150316908	1	1.539,87	510
NSB104-115	7314150323937	1	2.310,95	510
NSB104-120	7314150316915	1	1.975,17	510
NSB104-17	7314150323357	1	98,52	510
NSB104-19	7314150323364	1	101,15	510
NSB104-20	7314150323371	1	106,40	510
NSB104-22	7314150323388	1	108,00	510
NSB104-24	7314150316717	1	109,00	510
NSB104-25	7314150323395	1	129,61	510
NSB104-26	7314150323401	1	129,62	510
NSB104-27	7314150316724	1	137,91	510
NSB104-28	7314150323418	1	136,00	510
NSB104-29	7314150323425	1	139,03	510
NSB104-30	7314150316731	1	144,50	510
NSB104-31	7314150323432	1	149,04	510
NSB104-32	7314150316748	1	157,62	510
NSB104-33	7314150323449	1	149,04	510
NSB104-34	7314150323456	1	149,04	510
NSB104-35	7314150323463	1	149,04	510
NSB104-36	7314150316755	1	183,89	510
NSB104-37	7314150323470	1	200,60	510
NSB104-38	7314150323487	1	217,80	510
NSB104-39	7314150323494	1	254,56	510
NSB104-40	7314150323500	1	268,23	510
NSB104-41	7314150316762	1	288,97	510
NSB104-42	7314150323517	1	296,60	510
NSB104-43	7314150323524	1	304,34	510
NSB104-44	7314150323531	1	296,60	510
NSB104-45	7314150323548	1	301,77	510
NSB104-46	7314150316779	1	309,51	510
NSB104-47	7314150323555	1	335,06	510
NSB104-48	7314150323562	1	340,88	510
NSB104-49	7314150323579	1	346,72	510
NSB104-50	7314150316786	1	361,22	510
NSB104-51	7314150323586	1	361,22	510
NSB104-52	7314150323593	1	380,90	510
NSB104-53	7314150323609	1	373,11	510
NSB104-54	7314150323616	1	376,08	510
NSB104-55	7314150316793	1	400,63	510
NSB104-56	7314150323623	1	412,67	510
NSB104-57	7314150323630	1	419,56	510
NSB104-58	7314150323647	1	426,43	510
NSB104-59	7314150323654	1	433,30	510
NSB104-60	7314150316809	1	440,19	510
NSB104-61	7314150323661	1	456,65	510
NSB104-62	7314150323678	1	465,84	510
NSB104-63	7314150323685	1	480,43	510
NSB104-64	7314150323692	1	494,96	510
NSB104-65	7314150316816	1	481,46	510
NSB104-66	7314150323708	1	501,51	510
NSB104-67	7314150323715	1	509,53	510
NSB104-68	7314150323722	1	615,18	510
NSB104-69	7314150323739	1	615,18	510
NSB104-70	7314150316823	1	615,21	510
NSB104-71	7314150323746	1	619,57	510
NSB104-72	7314150323753	1	623,97	510
NSB104-73	7314150323760	1	628,36	510
NSB104-74	7314150323777	1	632,77	510
NSB104-75	7314150316830	1	637,16	510
NSB104-76	7314150323784	1	668,36	510
NSB104-77	7314150323791	1	676,70	510
NSB104-78	7314150323807	1	696,44	510
NSB104-79	7314150323814	1	716,25	510
NSB104-80	7314150316847	1	736,02	510
NSB104-81	7314150323821	1	777,18	510
NSB104-82	7314150323838	1	786,35	510
NSB104-83	7314150323845	1	795,52	510
NSB104-84	7314150323852	1	804,69	510
NSB104-85	7314150316854	1	813,88	510
NSB104-86	7314150323869	1	901,59	510
NSB104-87	7314150323876	1	921,44	510
NSB104-88	7314150323883	1	941,29	510
NSB104-89	7314150323890	1	961,17	510
NSB104-90	7314150316861	1	905,58	510
NSB104-92	7314150323906	1	1.031,65	510
NSB104-94	7314150323913	1	1.044,56	510
NSB104-95	7314150316878	1	1.057,48	510
NSB104-98	7314150323920	1	1.215,65	510
NSB106-100	7314150324361	1	825,32	511





NSB106-104	7314150324378	1	848,24	511
NSB106-108	7314150324385	1	869,44	511
NSB106-112	7314150324392	1	899,86	511
NSB106-114	7314150324408	1	951,39	511
NSB106-116	7314150324415	1	1.076,65	511
NSB106-120	7314150324422	1	1.122,59	511
NSB106-124	7314150324439	1	1.212,40	511
NSB106-126	7314150324446	1	1.309,39	511
NSB106-128	7314150324453	1	1.361,79	511
NSB106-132	7314150324460	1	1.414,18	511
NSB106-136	7314150324477	1	1.644,78	511
NSB106-138	7314150324484	1	1.685,89	511
NSB106-144	7314150324491	1	2.011,79	511
NSB106-146	7314150324507	1	2.749,44	511
NSB106-150	7314150324514	1	2.818,14	511
NSB106-156	7314150324521	1	2.826,31	511
NSB106-158	7314150324538	1	3.454,89	511
NSB106-20	7314150323944	1	105,08	510
NSB106-22	7314150323951	1	117,69	510
NSB106-24	7314150323968	1	123,98	510
NSB106-25	7314150323975	1	96,63	510
NSB106-26	7314150323982	1	110,69	510
NSB106-28	7314150323999	1	131,84	510
NSB106-30	7314150324002	1	134,00	510
NSB106-32	7314150324019	1	136,23	510
NSB106-34	7314150324026	1	140,62	510
NSB106-36	7314150324033	1	145,02	510
NSB106-38	7314150324040	1	149,21	510
NSB106-40	7314150324057	1	164,79	510
NSB106-42	7314150324064	1	169,16	510
NSB106-44	7314150324071	1	173,58	510
NSB106-45	7314150324088	1	219,21	510
NSB106-46	7314150324095	1	232,14	510
NSB106-48	7314150324101	1	235,58	510
NSB106-50	7314150324118	1	245,02	510
NSB106-52	7314150324125	1	261,74	510
NSB106-54	7314150324132	1	282,40	510
NSB106-56	7314150324149	1	288,97	510
NSB106-58	7314150324156	1	317,08	510
NSB106-60	7314150324163	1	354,65	510
NSB106-62	7314150324170	1	367,79	511
NSB106-64	7314150324187	1	385,99	511
NSB106-66	7314150324194	1	367,79	511
NSB106-68	7314150324200	1	380,90	511
NSB106-70	7314150324217	1	394,04	511
NSB106-71	7314150324224	1	399,00	511
NSB106-72	7314150324231	1	427,37	511
NSB106-74	7314150324248	1	427,37	511
NSB106-76	7314150324255	1	441,15	511
NSB106-78	7314150324262	1	496,46	511
NSB106-80	7314150324279	1	502,95	511
NSB106-82	7314150324286	1	483,35	511
NSB106-84	7314150324293	1	527,29	511
NSB106-88	7314150324309	1	659,12	511
NSB106-90	7314150324316	1	660,00	511
NSB106-92	7314150324323	1	732,61	511
NSB106-94	7314150324330	1	745,89	511
NSB106-96	7314150324347	1	756,56	511
NSB106-98	7314150324354	1	802,41	511
NSB200-1200	7314150324613	1	2.687,31	511
NSB200-200	7314150324545	1	313,17	511
NSB200-250	7314150324552	1	363,70	511
NSB200-300	7314150324569	1	394,01	511
NSB200-350	7314150324576	1	464,73	511
NSB200-450	7314150324583	1	565,76	511
NSB200-600	7314150324590	1	848,62	511
NSB200-900	7314150324606	1	1.474,99	511
NSB202-350	7314150324620	1	301,93	511
NSB203-200	7314150359561	1	128,27	511
NSB203-215	7314150359578	1	183,54	511
NSB203-290	7314150359585	1	213,58	511
NSB203-400	7314150359592	1	262,48	511
NSB203-490	7314150359608	1	390,23	511
NSB203-800	7314150359615	1	925,54	511
NSB204-30	7314150324637	1	234,36	512
NSB204-32	7314150324644	1	322,21	512
NSB204-35	7314150324651	1	260,79	512
NSB204-40	7314150324668	1	322,21	512
NSB204-45	7314150324675	1	393,10	512
NSB204-48	7314150324682	1	426,18	512
NSB204-50	7314150324699	1	452,63	512
NSB204-55	7314150324705	1	540,50	512
NSB204-60	7314150324712	1	582,10	512
NSB204-65	7314150324729	1	663,35	512
NSB204-70	7314150324736	1	728,56	512
NSB204-75	7314150324743	1	810,77	512
NSB204-80	7314150324750	1	922,28	512
NSB204-85	7314150324767	1	1.026,22	512
NSB204-90	7314150324774	1	1.132,05	512
NSB220-06	7314150354023	1	71,65	512
NSB220-07	7314150354030	1	73,43	512
NSB220-08	7314150354047	1	75,23	512
NSB220-09	7314150354054	1	77,03	512
NSB220-10	7314150354061	1	71,40	512
NSB220-11	7314150354078	1	75,09	512
NSB220-12	7314150354085	1	80,01	512



NSB220-13	7314150354092	1	83,71	512
NSB220-14	7314150354108	1	84,93	512
NSB220-15	7314150354115	1	87,40	512
NSB220-16	7314150354122	1	90,47	512
NSB220-17	7314150354139	1	92,94	512
NSB220-18	7314150354146	1	96,01	512
NSB220-19	7314150354153	1	100,33	512
NSB220-20	7314150354160	1	101,56	512
NSB220-21	7314150354177	1	104,62	512
NSB220-22	7314150354184	1	108,32	512
NSB220-23	7314150354191	1	114,64	512
NSB220-24	7314150354207	1	121,80	512
NSB220-25	7314150354214	1	136,63	512
NSB220-26	7314150354221	1	146,49	512
NSB220-27	7314150354238	1	153,87	512
NSB220-28	7314150354245	1	162,49	512
NSB220-29	7314150354252	1	175,04	512
NSB220-30	7314150354269	1	180,95	512
NSB220-32	7314150354276	1	198,80	512
NSB224-17	7314150355723	1	119,72	512
NSB224-18	7314150355730	1	147,70	512
NSB224-19	7314150355747	1	120,26	512
NSB224-21	7314150355754	1	132,43	512
NSB224-22	7314150355761	1	135,60	512
NSB224-23	7314150355778	1	169,54	512
NSB224-24	7314150355785	1	152,26	512
NSB224-26	7314150355792	1	158,43	512
NSB224-27	7314150355808	1	161,21	512
NSB224-28	7314150355815	1	171,08	512
NSB224-29	7314150355822	1	207,28	512
NSB224-30	7314150355839	1	219,84	512
NSB224-32	7314150355846	1	247,84	512
NSB224-34	7314150355853	1	266,69	512
NSB224-36	7314150355860	1	286,50	512
NSB224-38	7314150355877	1	305,84	512
NSB224-41	7314150355884	1	336,26	512
NSB224-46	7314150355891	1	397,62	513
NSB224-50	7314150355907	1	435,79	513
NSB228-22	7314150356126	1	170,16	513
NSB228-24	7314150356133	1	197,02	513
NSB228-26	7314150356140	1	214,94	513
NSB228-27	7314150356157	1	232,86	513
NSB228-28	7314150356164	1	229,87	513
NSB228-29	7314150356171	1	268,66	513
NSB228-30	7314150356188	1	286,57	513
NSB228-31	7314150356195	1	270,15	513
NSB228-32	7314150356201	1	302,70	513
NSB228-34	7314150356218	1	358,22	513
NSB228-36	7314150356225	1	376,13	513
NSB228-38	7314150356232	1	394,04	513
NSB228-41	7314150356249	1	403,00	513
NSB228-46	7314150356256	1	438,83	513
NSB228-50	7314150356263	1	465,66	513
NSB228-55	7314150356270	1	510,48	513
NSB228-60	7314150356287	1	635,85	513
NSB228-65	7314150356294	1	680,62	513
NSB228-70	7314150356300	1	752,27	513
NSB228-75	7314150356317	1	893,77	513
NSB228-80	7314150356324	1	949,28	513
NSB232-16-24	7314150356379	1	176,83	513
NSB232-24-16	7314150356393	1	213,47	513
NSB232-24-32	7314150356386	1	359,63	513
NSB232-32-24	7314150356409	1	348,10	513
NSB234-16-100	7314150356461	1	150,97	513
NSB234-16-200	7314150356478	1	167,22	513
NSB234-16-250	7314150356485	1	162,58	513
NSB234-24-200	7314150356492	1	234,57	513
NSB234-32-250	7314150356508	1	488,50	513
NSB236-16	7314150356553	1	224,16	514
NSB236-24	7314150356546	1	464,51	514
NSB236-32	7314150356560	1	707,32	514
NSB238-16-250	7314150356621	1	174,18	514
NSB238-24-250	7314150356614	1	267,09	514
NSB238-32-300	7314150356607	1	487,74	514
NSB240-16-230	7314150356744	1	219,21	514
NSB242-16	7314150356669	1	255,48	514
NSB242-24	7314150356676	1	510,96	514
NSB242-32	7314150356683	1	1.068,36	514
NSB243-16-400	7314150356706	1	339,22	514
NSB247-26	7314150356768	1	220,64	515
NSB248-16-52	7314150356720	1	110,66	515
NSB300-10-200	7314150317646	1	91,76	515
NSB300-10-300	7314150295845	1	98,82	515
NSB300-11-250	7314150317653	1	105,88	515
NSB300-11-300	7314150317660	1	112,93	515
NSB300-11-350	7314150295852	1	141,17	515
NSB300-12-400	7314150295869	1	169,41	515
NSB300-13-450	7314150295876	1	197,64	515
NSB300-3-50	7314150317530	1	21,00	515
NSB300-3-75	7314150317547	1	21,18	515
NSB300-4-75	7314150317554	1	26,83	515
NSB300-4.5-100	7314150295838	1	27,73	515
NSB300-4.5-50	7314150317561	1	23,99	515
NSB300-5-100	7314150317585	1	28,24	515
NSB300-5-75	7314150317578	1	29,46	515
NSB300-6-100	7314150285327	1	33,89	515



NSB300-6-125	7314150317592	1	33,89	515
NSB300-6-150	7314150317608	1	41,22	515
NSB300-7-150	7314150317615	1	41,22	515
NSB300-8-150	7314150285334	1	42,36	515
NSB300-8-200	7314150317622	1	65,25	515
NSB300-9-250	7314150317639	1	77,29	515
NSB301-10-200	7314150317974	1	81,27	516
NSB301-10-300	7314150317981	1	100,13	516
NSB301-3-50	7314150317905	1	30,83	516
NSB301-4-100	7314150317912	1	40,19	516
NSB301-4-150	7314150317929	1	52,92	516
NSB301-5-100	7314150317936	1	49,27	516
NSB301-5-200	7314150317943	1	70,60	516
NSB301-6-100	7314150317950	1	70,60	516
NSB301-8-150	7314150317967	1	84,70	516
NSB302-0-50	7314150295883	1	31,06	516
NSB302-1-100	7314150285341	1	31,06	516
NSB302-2-125	7314150285358	1	33,89	516
NSB302-3-150	7314150295890	1	49,43	516
NSB302-4-300	7314150295906	1	77,66	516
NSB304-0-50	7314150295913	1	31,06	516
NSB304-1-100	7314150295920	1	31,06	516
NSB304-2-125	7314150295937	1	33,89	516
NSB304-3-150	7314150295944	1	42,36	516
NSB304-4-300	7314150295951	1	77,66	516
NSB320-10	7314150318070	1	67,68	516
NSB320-2	7314150317998	1	43,91	516
NSB320-3	7314150318001	1	44,44	516
NSB320-4	7314150318018	1	45,14	516
NSB320-5	7314150318025	1	47,10	516
NSB320-6	7314150318032	1	49,12	516
NSB320-7	7314150318049	1	54,38	516
NSB320-8	7314150318056	1	57,07	516
NSB320-9	7314150318063	1	63,04	516
NSB400-160	7314150295968	1	169,41	516
NSB400-180	7314150285365	1	183,53	516
NSB400-200	7314150295975	1	197,64	516
NSB402-160	7314150295982	1	206,09	517
NSB402-200	7314150295372	1	253,86	517
NSB403-160	7314150318179	1	249,90	517
NSB403-180	7314150318186	1	262,67	517
NSB404-160	7314150318223	1	155,30	517
NSB405-160	7314150318230	1	270,97	517
NSB406-160	7314150295999	1	169,41	517
NSB406-180	7314150318254	1	197,20	517
NSB406-200	7314150296002	1	197,64	517
NSB407-160	7314150318285	1	372,09	518
NSB408-250	7314150285389	1	248,61	518
NSB408-300	7314150318308	1	301,06	518
NSB411-200	7314150318315	1	363,70	518
NSB412-200	7314150318346	1	141,17	518
NSB413-180	7314150318353	1	371,90	518
NSB413-200	7314150318360	1	371,90	518
NSB500-1000-FB	7314150324828	1	171,74	519
NSB500-1500-FB	7314150324835	1	247,52	519
NSB500-2000	7314150324781	1	325,15	518
NSB500-2000-FB	7314150324842	1	327,33	519
NSB500-2500	7314150324798	1	383,22	518
NSB500-2500-FB	7314150324859	1	420,27	519
NSB500-3000	7314150324804	1	452,90	518
NSB500-3000-FB	7314150324866	1	499,08	519
NSB500-3500-FB	7314150324873	1	630,40	519
NSB500-4000	7314150324811	1	454,59	518
NSB502-1000-FB	7314150316922	1	164,44	519
NSB502-10000-FB	7314150316991	1	1.444,87	519
NSB502-12000-FB	7314150318414	1	1.971,63	519
NSB502-1500-FB	7314150318421	1	219,25	519
NSB502-2000-FB	7314150316939	1	301,48	519
NSB502-2500-FB	7314150316946	1	383,69	519
NSB502-3000-FB	7314150316953	1	465,91	519
NSB502-450-FB	7314150324880	1	117,78	519
NSB502-4500-FB	7314150316960	1	616,65	519
NSB502-5000-FB	7314150316977	1	671,46	519
NSB502-6800-FB	7314150318452	1	931,82	519
NSB502-8000-FB	7314150316984	1	986,63	519
NSB504-100-FB	7314150317004	1	63,53	519
NSB504-1000-FB	7314150317059	1	209,85	519
NSB504-1500-FB	7314150317066	1	283,93	519
NSB504-200-FB	7314150317011	1	86,40	519
NSB504-2000-FB	7314150317073	1	343,18	519
NSB504-300-FB	7314150317028	1	106,14	519
NSB504-500-FB	7314150317035	1	133,32	519
NSB504-800-FB	7314150317042	1	172,82	519
NSB506-300	7314150324897	1	74,08	519
NSB506-300-FB	7314150318490	1	75,50	520
NSB506-450	7314150324903	1	98,75	519
NSB506-450-FB	7314150318483	1	100,65	520
NSB506-700	7314150324910	1	138,88	519
NSB506-700-FB	7314150317080	1	126,98	520
NSB506-900	7314150324927	1	185,15	519
NSB506-900-FB	7314150317097	1	193,22	520
NSB508-500-FB	7314150318513	1	111,13	520
NSB508-700-FB	7314150318520	1	131,33	520
NSB512-200-FB	7314150318643	1	94,97	520
NSB512-400-FB	7314150318636	1	119,20	520
NSB512-600-FB	7314150318629	1	131,33	520



NSB512-900-FB	7314150318605	1	185,81	520
NSB600-100-50	7314150317110	1	49,38	520
NSB600-135-50	7314150317127	1	93,82	520
NSB600-150-25	7314150317134	1	44,45	520
NSB600-150-30	7314150317141	1	47,27	520
NSB600-150-40	7314150317158	1	51,09	520
NSB600-150-50	7314150317165	1	83,95	520
NSB600-180-13	7314150317172	1	38,11	520
NSB600-180-32	7314150317189	1	56,78	520
NSB600-180-50	7314150317196	1	125,92	520
NSB600-200-20	7314150317202	1	111,11	520
NSB600-200-30	7314150317219	1	135,79	520
NSB600-200-40	7314150317226	1	211,26	520
NSB600-200-50	7314150317233	1	99,02	520
NSB600-230-40	7314150317240	1	143,20	520
NSB600-250-40	7314150317257	1	222,20	520
NSB600-300-50	7314150317264	1	434,54	520
NSB600-80-13	7314150317103	1	13,34	520
NSB602-460	7314150324934	1	299,78	521
NSB602-600	7314150324941	1	136,94	521
NSB602-760	7314150324958	1	621,79	521
NSB602-900	7314150324965	1	737,13	521
NSB604-150	7314150324972	1	128,70	521
NSB604-200	7314150324989	1	172,62	521
NSB604-300	7314150324996	1	343,17	521
NSB606-150	7314150325009	1	87,03	521
NSB606-200	7314150325016	1	111,91	521
NSB606-250	7314150325023	1	151,28	521
NSB606-300	7314150325030	1	205,17	521
NSB606-400	7314150325047	1	264,11	521
NSB608-100	7314150325054	1	68,61	521
NSB700-300	7314150296255	1	175,31	522
NSB702-200	7314150296262	1	85,37	522
NSB704-225	7314150296279	1	189,99	522
NSB706-50	7314150296286	1	120,18	522
NSB706-80	7314150296293	1	184,41	522
NSB708-360	7314150296309	1	222,15	522
NSB710-450	7314150296316	1	472,36	523
NSB800-1100	7314150325061	1	273,93	523
NSB800-1700	7314150325078	1	400,46	523
NSB800-2000	7314150325085	1	477,86	523
NSB802-290	7314150325092	1	426,73	523
NSB810-100	7314150318650	1	1.270,80	523
NSB810-150	7314150318667	1	1.410,80	523
NSB810-200	7314150318674	1	1.507,39	523
NSB810-350	7314150318681	1	2.540,71	523
P-HB	7314150125272	25	0,77	542
P-MEC	7314150374342	24	5,53	543
P-MEC-LEAD	7314150374359	12	4,01	543
P1-20	7311518044572	5	42,36	621
P1-23	7311518332501	5	47,66	621
P108-20-F	7311518275518	2	31,82	621
P108-23-F	7311518275525	2	36,37	621
P11	7311518009076	6	40,53	632
P110-20-F	7311518275532	2	30,68	621
P110-23-F	7311518275549	2	34,78	621
P114-SL-40	7311518301149	2	76,27	624
P114-SL-50	7311518301156	2	77,85	624
P114-SL-60	7311518301163	2	84,78	624
P116-SL-40	7311518301101	2	87,96	625
P116-SL-50	7311518301118	2	92,11	625
P116-SL-60	7311518301125	2	94,98	625
P116-SL-70	7311518301132	2	97,90	625
P121-18-F	7311518275662	6	23,30	622
P121-20-F	7311518275631	6	24,43	622
P121-23-F	7311518275648	6	25,57	622
P123-19-BULK30	7311518218218	30	11,45	624
P126-19-F	7311518275297	6	17,50	622
P126-22-F	7311518275303	6	22,50	622
P127-19-BULK30	7311518199333	30	11,26	624
P128-19	7311518160814	6	14,68	624
P128-19-BULK30	7311518172329	30	11,56	624
P129-19-BULK30	7311518172336	30	12,55	624
P130-F	7311518333980	6	36,08	625
P138-22-BULK6	7311518328696	6	29,87	622
P138-22-F	7311518301279	6	42,97	622
P140-F	7311518275372	6	45,77	625
P16-40	7311518013479	2	76,09	624
P16-40W	7311518043049	2	75,91	624
P16-50-F	7311518301286	2	91,90	624
P16-60-F	7311518276461	2	94,97	624
P160-SL-60	7311518301170	2	102,45	625
P160-SL-75	7311518301187	1	108,63	625
P160-SL-90	7311518301194	1	116,25	625
P173-SL-85	7311518334703	1	106,04	625
P19-80-F	7311518275365	1	167,73	625
P20	7311518009281	6	48,11	632
P241	7311518008956	5	12,68	617
P262	7311518299286	10	16,32	616
P263	7311518299262	10	18,36	616
P264	7311518299279	10	16,45	616
P266	7311518299293	10	16,25	617
P267	7311518299309	10	16,91	616
P268	7311518299316	10	16,91	616
P269	7311518299323	10	13,28	617
P270	7311518299330	10	15,77	617





P272	7311518299354	5	20,87	616
P274	7311518299347	5	20,28	616
P276	7311518299361	5	20,81	617
P277	7311518299378	5	21,29	616
P278	7311518299385	5	21,16	616
P280-SL-60	7311518346508	2	67,90	625
P280-SL-80	7311518301330	2	73,87	625
P3-20-F	7311518275259	2	60,85	621
P3-23-F	7311518275266	2	63,24	621
P34-27A-F	7311518275464	2	36,37	627
P34-37	7311518002787	2	68,18	627
P5-23-F	7311518275280	2	71,15	621
P51-F	7311518275426	2	51,71	630
P51-SL	7311518301217	2	51,71	630
P51H-SL	7311518301224	2	54,55	630
P52-SL-20	7311518347307	2	88,60	631
P54-SL-25	7311518301231	2	106,82	631
P54H-SL-25	7311518301255	2	106,81	631
P57-25-F	7311518301293	4	39,77	630
P59-25-F	7311518275655	6	33,17	631
P6160	7314150115075	10	75,00	647
P64-20-BULK12	7311518288204	12	39,68	622
P74	7311518124076	40	61,63	632
P75	7311518124083	48	60,53	632
PAGS-2.0	7311518327835	1	31,19	601
PAGS-2.0-900FG	7311518292355	1	74,97	601
PBB-8	7314150399376	8	24,10	542
PBS-700	7314150341689	6	24,63	542
PC-10-DTF	7311518263560	10	27,46	566
PC-10-DTL	7311518263553	10	17,96	566
PC-10-DTR	7311518263546	10	17,96	566
PC-11-19-PS	7311518285548	4	45,87	565
PC-11-19-PS-B	7311518285555	10	31,31	565
PC-12-14-PS	7311518285562	4	41,58	565
PC-12-14-PS-B	7311518285579	10	29,00	565
PC-12-COM	7311518263454	4	21,57	560
PC-12-TEN	7311518263447	4	31,07	564
PC-12-VEN	7311518263430	4	33,61	564
PC-15-GNP	7311518264307	4	28,50	560
PC-15-TBX	7311518263423	4	27,49	564
PC-16-DECO	7311518264987	4	28,50	561
PC-16-FILE-U7	7311518263461	4	19,34	562
PC-19-FILE-U7	7311518263478	4	20,68	562
PC-19-GT7	7311518263362	4	29,16	562
PC-19-GT9	7311518263379	4	29,16	564
PC-20-LAM	7311518258290	4	31,83	563
PC-20-PRC	7311518264291	4	48,19	564
PC-22-FILE-U7	7311518263485	4	22,00	562
PC-22-GT7	7311518263393	4	30,48	562
PC-22-GT9	7311518263409	4	30,48	564
PC-22-INS	7314150154500	4	31,02	561
PC-22-PLC	7314150276318	4	31,17	560
PC-24-FILE-U7	7311518263492	4	31,46	562
PC-24-PLS	7311518263508	4	36,93	560
PC-24-TIM	7311518263515	4	49,68	565
PC-6-DRY	7311518282004	6	22,95	560
PC-9-9/17-PS	7311518285586	4	42,15	565
PC-9-9/17-PS-B	7311518285593	10	31,58	565
PENCIL-200-DISP	7314150125227	1	181,35	543
PG-01-F	7311518329334	6	31,68	622
PG-03-L	7311518242855	2	32,68	622
PG-12-BULK15	7311518334628	15	13,97	622
PG-12-F	7311518328122	10	15,06	622
PG-18-45-F	7311518299033	2	39,77	625
PG-18-60-F	7311518288853	2	43,19	625
PG-19-F	7311518295936	2	58,73	625
PG-56-F	7311518288938	2	40,91	631
PG-57-F	7311518295943	2	43,19	631
PG-72	7311518242534	4	17,80	634
PH-6604-1P	7311518152819	15	3,11	35
PH-6604-25	7311518141134	25	1,99	35
PS501-1	7314150338283	1	197,83	654
PS501-2	7314150112432	1	220,37	654
PS501-3	7314150338290	1	227,89	654
PS501-4	7314150338306	1	234,15	654
PU-14	7314150016266	5	10,91	44
PU-20	7314150016389	3	16,06	44
PU-22	7314150016426	3	21,50	44
PU-24	7314150016464	3	24,48	44
PU-6	7314150016105	5	7,30	44
PU-9	7314150016167	5	8,84	44
PX-L2	7311518233853	2	56,50	620
PX-L3	7311518233860	2	56,50	620
PX-M1	7311518233815	2	56,50	620
PX-M2	7311518233822	2	56,50	620
PX-M2-L	7311518240714	2	56,50	620
PX-M3	7311518233839	2	56,50	620
PX-S1	7311518233785	2	56,50	620
PX-S2	7311518233792	2	56,50	620
PXR-L2	7311518233914	2	81,81	620
PXR-M1	7311518233877	2	81,81	620
PXR-M2	7311518233884	2	81,81	620
PXR-M2-L	7311518240738	2	81,81	620
PXR-M3	7311518233891	2	81,81	620
PXR-S1	7311518240677	2	81,81	620
PXR-S2	7311518240684	2	81,81	620



PXR-S2-L	7311518346799	2	81,81	620
QC-115A	7314150460007	12	3,15	588
QC-115A-2P	7314150460021	6	6,28	588
QC-150A	7314150460045	6	7,08	588
QC-150A-2P	7314150460069	6	14,17	588
QC-300A	7314150401925	6	11,15	588
QC-300A-2P	7314150460090	4	22,30	588
QCB-1250	7314150135981	8	50,99	588
QCB-150	7314150135912	6	31,64	588
QCB-300	7314150135936	6	33,92	588
QCB-450	7314150135950	6	36,22	588
QCB-600	7314150135967	4	38,88	588
QCB-900	7314150135974	4	42,50	588
QCG-150	7314150135899	6	20,99	588
QCG-300	7314150135905	6	23,89	588
R1068	7311518044398	1	6,30	623
R1069P	7311518219574	12	5,30	623
R1071	7311518222918	14	10,64	624
R1075-BULK50	7311518220495	50	1,07	624
R1080P	7311518282479	1	6,22	623
R112PG	7311518010058	1	16,95	622
R113PG	7311518044374	30	18,29	623
R114PG	7311518010065	1	17,14	622
R114V	7311518042660	25	32,96	625
R114V-BULK28	7311518177539	28	22,84	625
R115V	7311518243210	8	32,87	625
R115V-BULK14	7311518288341	14	26,73	625
R116V	7311518010164	1	29,73	625
R116V-BULK36	7311518159924	36	25,55	625
R119V	7311518029487	1	51,35	625
R122PG	7311518010072	30	18,00	622
R123PG	7311518044381	30	18,11	623
R124PG	7311518010089	30	18,29	622
R1269P-BULK50	7311518240820	50	1,37	621
R133PG	7311518328252	1	12,83	629
R137E	7311518011574	30	20,72	628
R142P	7311518010126	24	7,71	623
R143PV	7311518010133	1	7,04	626
R143PVCB	7311518255633	1	7,67	626
R144PV	7311518291075	24	7,10	626
R146VC	7311518046545	22	8,22	631
R146VS	7311518046538	24	7,12	626
R146VS-BULK50	7311518159955	50	4,61	626
R147V	7311518044909	24	7,11	631
R148V	7311518223922	1	15,61	623
R1601	7311518044640	1	8,30	623
R160A	7311518201821	1	25,30	625
R160A-BULK28	7311518337216	28	19,88	625
R166V	7311518328085	22	9,51	626
R16V	7311518254513	1	33,05	625
R16V-BULK14	7311518288334	14	22,92	625
R181P	7311518296087	1	23,17	625
R185V	7311518331795	25	24,46	625
R201P	7311518219536	1	20,98	622
R201P-BULK80	7311518225209	80	12,45	622
R202P	7311518219550	1	21,55	623
R211P	7311518234027	1	20,06	620
R211P-BULK80	7311518252212	80	18,67	620
R214SL	7311518301392	1	25,80	626
R214V	7311518042745	1	27,93	626
R214V-BULK28	7311518177553	28	15,03	626
R215V	7311518243227	1	28,58	626
R216SL	7311518301408	8	27,06	626
R221P	7311518229412	1	7,47	622
R221P-BULK50	7311518240653	50	5,67	622
R223P	7311518237554	1	20,41	622
R223P-BULK80	7311518240646	80	17,00	622
R230P	7311518341503	10	23,98	628
R239P	7311518219567	1	8,50	623
R260A	7311518201814	16	24,93	626
R272H	7311518258016	1	9,98	626
R300P	7311518234034	1	19,70	620
R303P	7311518234157	1	21,03	620
R310-0	7314151829797	1	42,83	56
R310-1	7314151829803	1	48,30	56
R310-2	7314151829810	1	71,58	56
R310-3	7314151829827	1	91,48	56
R312V	7311518235420	1	15,02	626
R315V	7311518243234	1	12,67	626
R318V	7311518029500	1	13,58	626
R328V	7311518296056	22	6,67	626
R335V	7311518331801	12	10,62	626
R337E	7311518011598	1	10,38	629
R341P	7311518011529	12	5,05	623
R372H	7311518235406	1	19,66	626
R373A	7311518334710	25	32,76	625
R403P	7311518234164	1	21,25	620
R415V	7311518243241	1	9,92	626
R4230	7311518341510	10	7,15	628
R427AE	7311518176068	18	9,33	629
R434P	7311518223885	1	6,67	623
R434P-BULK50	7311518169916	50	1,93	623
R437E	7311518011611	18	10,38	629
R438P	7311518229429	1	6,31	623
R438P-BULK50	7311518240660	50	1,94	623
R440V	7311518254544	22	7,65	626

			€	
R444V	7311518243340	22	5,94	631
R463P	7311518223908	1	7,38	623
R472H	7311518334840	30	16,71	626
R474P	7311518011536	1	4,88	623
R478P	7311518275600	1	9,00	624
R480P	7311518282486	1	7,28	624
R500P	7311518234041	40	19,78	620
R503P	7311518234171	1	19,28	620
R515VS	7311518046514	22	5,29	631
R516V	7311518200824	22	4,45	631
R519V	7311518029517	1	10,11	626
R600P	7311518240783	1	19,61	620
R603P	7311518240790	1	18,77	620
R615V	7311518010119	1	9,38	626
R619V	7311518029494	1	31,72	626
R660V	7311518210281	24	8,78	626
R6725MK	7314151088354	1	259,10	69
R6725ZK	7314151784898	1	248,84	69
R680V	7311518042752	1	24,21	626
R6810M-10	7314150195152	5	13,57	78
R6810M-3,4	7314150195077	5	11,56	78
R6810M-4	7314150195084	5	11,56	78
R6810M-4,5	7314150195091	5	11,56	78
R6810M-5	7314150195107	5	11,81	78
R6810M-6	7314150195114	5	11,81	78
R6810M-7	7314150195121	1	12,07	78
R6810M-8	7314150195138	5	12,75	78
R6810M-9	7314150195145	5	12,75	78
R6810Z-1/4	7314150429448	1	11,82	79
R6810Z-3/16	7314150429387	1	11,82	79
R6810Z-3/8	7314150429394	1	14,38	79
R6810Z-5/16	7314150429400	1	14,38	79
R6810Z-7/32	7314150429417	1	11,82	79
R6822Z	7314150429424	5	14,39	79
R6950	7314151089658	1	104,43	84
R6964A	7314150195176	1	6,40	79
R6967	7314150195169	5	13,51	79
R716VCB	7311518255497	40	27,80	626
R772V	7311518301385	14	6,51	626
R773V	7311518324414	1	6,12	626
R775V	7311518331818	1	10,16	626
R776V	7311518334734	1	18,50	626
R801P	7311518234126	1	38,08	620
R802P	7311518234133	1	38,37	620
R803P	7311518234140	1	38,46	620
R804P	7311518240806	1	33,30	620
R811P	7311518234058	1	26,00	620
R812P	7311518234065	1	24,59	620
R813P	7311518234072	1	24,60	620
R815P	7311518240752	1	25,66	620
R900P	7311518234188	1	8,00	620
R901P	7311518234195	30	7,17	620
R902P	7311518234201	24	6,45	621
R903P	7311518234218	1	5,26	621
R904P	7311518234225	1	7,36	621
R905P	7311518234232	1	5,87	621
R905P-BULK50	7311518252250	50	2,32	621
R906P	7311518234249	1	5,87	621
R906P-BULK50	7311518252267	50	2,46	621
R907P	7311518234256	1	6,10	621
RAIL-10	7314150511075	10	2,84	82
RAIL-340	7314153003645	3	3,21	82
RAIL-8	7314150511051	10	2,58	82
RAUNI	7311518339289	6	17,95	627
RB-SET-AL06-5P	7314150501489	1	352,31	148
RB-SET-M06X-10P	7314150501557	1	380,50	148
RB-SET1-M06X-5P	7314150501588	1	200,93	148
RB-SET2-M06X-5P	7314150501618	1	159,25	148
RBCP	7311518339272	10	10,95	628
RBCP230	7311518341558	12	10,58	628
RCAM30	7311518346959	20	4,34	628
RCAM36	7311518346973	20	4,34	628
RD1M	7311518341534	15	13,17	628
RD7M	7311518341541	20	24,58	629
RPL230G	7311518341527	8	25,22	629
RT821P	7311518242237	1	49,92	620
RT822P	7311518234102	1	47,89	620
RT823P	7311518234119	6	55,10	620
RT824P	7311518240776	1	65,33	620
RT825P	7311518347147	6	49,94	620
RX 01	7314150103263	1	6,29	649
RX 7390	7314150342587	10	63,09	651
RX 7392	7314150342594	10	63,09	651
RX 7490	7314150103195	10	68,31	650
RX 7590	7314150103201	10	68,62	650
RX 7890	7314150103218	10	72,15	651
RX 7891	7314150103225	10	67,19	651
RX 7892	7314150103232	10	80,54	651
RX 7893	7314150103249	10	74,27	651
RX 7894	7314150212101	10	66,73	652
RX 8130	7314150103003	10	77,30	644
RX 8131	7314150103010	10	82,80	644
RX 8132	7314150103027	10	95,60	644
RX 8137	7314150392926	10	77,50	645
RX 8140	7314150103034	10	68,20	644

			€	
RX 8141	7314150103041	10	74,78	644
RX 8142	7314150103058	10	79,29	644
RX 8142PS	7314150349371	10	73,90	649
RX 8143	7314150103065	10	82,98	644
RX 8144	7314150103072	10	81,27	644
RX 8145	7314150103089	10	81,23	644
RX 8146	7314150103096	10	68,31	645
RX 8147	7314150103102	10	83,57	645
RX 8147PS	7314150425402	10	93,60	649
RX 8148	7314150103119	10	93,25	645
RX 8149	7314150103126	10	171,21	648
RX 8150	7314150103133	10	80,23	644
RX 8151	7314150103140	10	87,12	644
RX 8152	7314150103157	10	86,74	644
RX 8153	7314150412976	10	33,55	644
RX 8154	7314150351435	10	33,55	644
RX 8156	7314150411528	10	61,11	645
RX 8157	7314150383733	10	74,80	645
RX 8158	7314150117130	10	169,45	645
RX 8160	7314150111534	10	76,25	644
RX 8161	7314150111541	10	92,48	644
RX 8161PS	7314150410750	10	52,26	649
RX 8162	7314150111558	10	101,46	644
RX 8164	7314150116270	10	113,38	644
RX 8165	7314150116287	10	116,12	644
RX 8167	7314150383726	10	128,14	645
RX 8168	7314150115495	10	209,74	645
RX 8211	7314150103188	10	136,03	646
RX 8247	7314150103164	10	84,26	646
RX 8248	7314150103171	10	149,17	647
RX112A-0.3	7314150411498	5	151,41	653
RX112A-1.0	7314150384020	10	151,41	653
RX112A-1.5	7314150352425	10	151,41	653
RX112A-2.0	7314150384037	10	200,92	653
RX304D	7314150476701	5	150,02	653
RX331A	7314150434725	10	77,50	653
RX8133	7314150476749	10	66,95	644
RX8134	7314150476756	10	66,95	644
RX8135	7314150476763	10	66,95	644
RX8136	7314150476770	10	66,95	645
RX8137MX	7314150358519	10	77,50	645
RX8138	7314150346561	10	77,50	645
RX8138MX	7314150349395	10	59,63	645
RX8140M2	7314150476787	10	116,21	649
RX8140PS	7314150360635	10	116,21	649
RX8141PS	7314150349432	10	39,10	649
RX8143PS	7314150360642	10	70,13	649
RX8150M2	7314150476794	10	48,32	649
RX8150PS	7314150358502	10	92,13	649
RX8155	7314150374014	10	131,14	644
RX8160BPS	7314150360048	10	66,66	650
RX8160M2	7314150476800	10	183,94	649
RX8163	7314150476817	10	57,59	644
RX8166	7314150476558	10	57,59	645
RX8233A	7314150436279	10	198,15	648
RX8234A	7314150436286	10	185,76	648
RX8237A	7314150436293	10	185,75	648
S0810L	7314150256594	20	31,84	63
S103	7314150257119	2	289,07	62
S103-CASE	7314150321261	1	62,10	102
S106	7314150103997	2	305,91	62
S108	7314150122257	2	306,94	62
S108-CASE	7314150349319	1	60,01	102
S1214L	7314150256600	10	58,25	69
S137	7314150450503	2	418,85	63
S138	7314150195022	2	324,45	63
S140T	7314150125203	1	70,90	70
S140T-R	7314150136353	10	43,26	70
S160	7314150104031	6	49,44	64
S160AF	7314150137510	6	49,44	64
S1612L	7314150256617	4	71,63	72
S18HEX	7314150412457	4	98,67	72
S18TORX	7314150412464	4	101,00	72
S240	7314150104017	4	123,95	72
S240AF	7314150111077	4	123,95	72
S240AF-CASE	7314150187317	1	44,82	102
S290	7314153000859	6	71,58	64
S330	7314150104024	6	78,26	69
S330-CASE	7314150136223	1	31,01	102
S330AF	7314150137503	6	78,26	70
S330L	7314150256587	4	114,01	69
S330L-CASE	7311518337674	1	43,44	102
S350AF	7314150137527	2	192,56	73
S380	7314150168934	4	113,16	70
S400	7314150111053	2	183,64	72
S400-CASE	7314150187300	1	50,57	102
S410	7314153019370	2	126,69	62
S410-CASE	7314150321223	1	50,58	102
S460	7314150111060	6	110,91	64
S460-CASE	7314150321209	1	44,83	102
S4RM-12-15	7314150179954	1	31,14	47
S4RM-16-19	7314150179961	1	37,52	47
S4RM-21-27	7314150179978	1	72,48	47
S4RM-30-36	7314150179985	1	133,41	47
S4RM-4-7	7314150179930	1	20,85	47
S4RM-8-11	7314150179947	1	23,06	47



S4RM/3T



S4RM/3T	7314150117406	20	94,49	47
S4RM/4T	7314150179916	1	154,46	48
S4RM/5T	7314150179923	1	311,27	48
S530T	7314150169122	4	196,41	70
S560	7314150122264	4	118,45	63
S560-CASE	7314150321216	1	44,50	102
S800	7314150165599	2	290,56	62
S81MIX	7314150180127	2	221,45	62
S81MIX-CASE	7314150321247	1	60,67	102
S87+7	7314150103980	2	262,65	62
S910	7314150104000	2	218,36	62
S910AF	7314150137541	2	218,36	63
S95	7314150409167	2	235,09	62
S9HEX	7314150412433	10	49,44	72
S9TORX	7314150412440	10	49,44	72
SB-2058/S26	7314151849498	1	35,15	168
SB-2448	7314150136056	12	30,67	572
SB-2449	7314150194049	10	27,49	572
SB-3732-2-125	7314151847869	60	5,94	608
SB-3732-2.5-125	7314151847876	60	5,94	608
SB-3732-3.2-125	7314151847883	60	5,94	608
SB-3732-4-125	7314151847890	1	5,94	608
SB-3734N-10-150	7314151848101	1	8,36	607
SB-3734N-2-150	7314151847968	1	6,92	607
SB-3734N-3-150	7314151847975	1	6,92	607
SB-3734N-4-150	7314151847982	60	7,12	607
SB-3734N-5-150	7314151847999	1	7,12	607
SB-3734N-6-150	7314151848071	60	8,36	607
SB-3734N-7-150	7314151848088	1	8,36	607
SB-3734N-8-150	7314151848095	1	8,36	607
SB-3735N-2-100	7314151847906	1	6,33	606
SB-3735N-4-120	7314151847913	60	6,93	606
SB-3735N-5-120	7314151847920	1	7,74	606
SB-3735N-6-150	7314151847937	1	8,36	606
SB-3735N-8-150	7314151847944	1	8,36	606
SB-3740-125	7314150115990	87	11,52	604
SB-3740-150	7314150116003	25	13,11	604
SB-3740-175	7314150116010	25	14,67	604
SB-3740-200	7314150116027	25	15,27	604
SB-3740-250	7314150116034	25	16,11	604
SB-3740-300	7314150116041	25	16,91	604
SB-9526/S6	7314150154234	20	47,03	154
SB111M-10	7314151839864	1	8,55	40
SB111M-11	7314151839871	1	9,20	40
SB111M-12	7314151839888	1	9,64	40
SB111M-13	7314151839895	1	10,11	40
SB111M-14	7314151839901	1	10,51	40
SB111M-15	7314151839918	1	10,83	40
SB111M-16	7314151839925	1	11,64	41
SB111M-17	7314151839932	1	12,14	41
SB111M-18	7314151839949	1	12,71	41
SB111M-19	7314151839956	1	14,41	41
SB111M-20	7314151839963	1	14,52	41
SB111M-21	7314151839970	1	16,49	41
SB111M-22	7314151839987	1	16,61	41
SB111M-23	7314151839994	1	17,54	41
SB111M-24	7314151840006	1	18,32	41
SB111M-25	7314151840013	1	19,77	41
SB111M-26	7314151840020	1	19,25	41
SB111M-27	7314151840037	1	21,55	41
SB111M-28	7314150432103	1	26,58	41
SB111M-29	7314151840051	1	28,79	41
SB111M-30	7314151840068	1	30,83	41
SB111M-32	7314151840075	1	34,31	41
SB111M-5.5	7314151839819	1	6,80	40
SB111M-6	7314151839826	1	7,05	40
SB111M-7	7314151839833	1	7,10	40
SB111M-8	7314151839840	1	7,27	40
SB111M-9	7314151839857	1	8,49	40
SB141.007.075	7314150282753	1	8,99	206
SB141.008.075	7314150282760	1	9,02	206
SB141.009.075	7314150282777	1	9,04	206
SB141.010.075	7314150282784	1	9,07	206
SB141.015.100	7314150282791	1	9,13	206
SB141.020.100	7314150282807	1	9,17	206
SB141.025.125	7314150282814	1	9,53	206
SB141.027.125	7314150282821	1	9,66	206
SB141.030.150	7314150282838	1	10,90	206
SB141.040.150	7314150282845	1	12,60	206
SB142.000.075	7314150282579	1	7,55	496
SB142.001.080	7314150282586	1	8,89	496
SB142.002.100	7314150282593	1	10,92	496
SB142.003.150	7314150282609	1	16,05	496
SB143.020.100	7314150282852	1	4,75	206
SB143.025.100	7314150282869	1	4,83	206
SB143.030.100	7314150282876	1	4,88	206
SB143.040.100	7314150282883	1	5,44	206
SB143.050.100	7314150282890	1	6,58	206
SB143.060.125	7314150282906	1	7,46	206
SB143.080.150	7314150282913	1	10,34	206
SB144.001.100	7314150282951	1	7,64	206
SB144.002.125	7314150282968	1	8,15	206
SB144.003.150	7314150282975	1	8,46	206
SB145.006.100	7314150282920	1	7,34	207
SB146.006.100	7314150282937	1	7,66	207
SB148.001.080	7314150314577	1	10,53	496



SB148.002.100	7314150314584	1	11,17	496
SB149.001.080	7314150314591	1	10,73	496
SB149.002.100	7314150314607	1	11,43	496
SB150.010.100	7314150343492	1	7,05	496
SB150.015.125	7314150343515	1	7,10	496
SB150.020.125	7314150343577	1	7,21	496
SB150.025.150	7314150343584	1	7,44	496
SB190.040.075	7314150281985	1	5,45	204
SB190.040.100	7314150282098	1	5,51	204
SB190.055.100	7314150281992	1	6,78	204
SB190.055.125	7314150282005	1	6,91	204
SB190.065.125	7314150282012	1	8,34	204
SB190.065.150	7314150282029	1	9,37	204
SB190.080.150	7314150282036	1	10,21	204
SB190.080.175	7314150282043	1	10,47	204
SB190.100.200	7314150282050	1	13,53	204
SB190.120.250	7314150282067	1	17,34	204
SB190.140.250	7314150282074	1	18,42	204
SB191.025.075	7314150282081	1	4,13	204
SB191.030.075	7314150282108	1	4,24	204
SB191.030.100	7314150282111	1	4,50	204
SB191.030.200	7314150282128	1	6,76	204
SB191.035.100	7314150282135	1	4,63	204
SB191.040.100	7314150282142	1	5,15	204
SB191.040.125	7314150282159	1	5,60	204
SB191.040.250	7314150282166	1	7,98	204
SB191.055.125	7314150282173	1	6,90	204
SB191.055.150	7314150282180	1	7,62	204
SB191.055.300	7314150282197	1	10,02	204
SB191.065.150	7314150282203	1	8,84	204
SB191.065.300	7314150282210	1	11,38	204
SB192.000.075	7314150282357	1	5,41	205
SB192.000.200	7314150282364	1	7,47	205
SB192.001.100	7314150282371	1	6,47	205
SB192.001.250	7314150282388	1	9,31	205
SB192.002.125	7314150282395	1	7,87	205
SB192.002.300	7314150282401	1	11,52	205
SB192.003.150	7314150282418	1	11,70	205
SB192.004.200	7314150282425	1	15,92	205
SB193.000.075	7314150282456	1	6,30	205
SB193.001.100	7314150282463	1	6,97	205
SB193.002.125	7314150282470	1	8,34	205
SB193.003.150	7314150282487	1	12,30	205
SB193.004.200	7314150282494	1	16,83	205
SB194.004.075	7314150282616	1	7,34	206
SB194.005.075	7314150282623	1	7,16	206
SB194.006.075	7314150282630	1	6,67	206
SB194.007.075	7314150282647	1	6,70	206
SB194.008.075	7314150282654	1	6,72	206
SB194.009.075	7314150282661	1	6,75	206
SB194.010.075	7314150282678	1	6,76	206
SB194.015.100	7314150282685	1	6,90	206
SB194.020.100	7314150282692	1	6,97	206
SB194.025.125	7314150282708	1	7,38	206
SB194.027.125	7314150282715	1	7,55	206
SB194.030.150	7314150282722	1	8,88	206
SB194.040.150	7314150282739	1	10,55	206
SB194.045.150	7314150282746	1	11,27	206
SB195.001.025	7314150282432	1	6,67	205
SB195.002.025	7314150282449	1	6,67	205
SB195.006.050	7314150289516	1	6,67	207
SB195.040.025	7314150282227	1	5,15	204
SB195.050.025	7314150282234	1	6,41	204
SB195.060.025	7314150282241	1	6,67	204
SB195.901.025	7314150282500	1	7,01	205
SB195.902.025	7314150282517	1	7,43	205
SB1952M-10	7314150105205	1	11,37	43
SB1952M-12	7314150105229	1	12,72	43
SB1952M-13	7314150105236	1	13,69	43
SB1952M-14	7314150105243	1	13,81	43
SB1952M-17	7314150105274	1	17,87	43
SB1952M-19	7314150105298	1	20,77	43
SB1952M-24	7314150105342	1	28,48	43
SB1952M-7	7314150105441	1	10,36	43
SB1952M-8	7314150105458	1	10,21	43
SB196.025.075	7314150282258	1	6,73	495
SB196.030.100	7314150282265	1	6,63	495
SB196.035.100	7314150282272	1	6,90	495
SB196.040.100	7314150282289	1	7,88	495
SB196.055.125	7314150282296	1	9,27	495
SB196.065.150	7314150282302	1	11,64	495
SB196.080.175	7314150282326	1	12,79	495
SB196.100.200	7314150282333	1	16,49	495
SB196.120.200	7314150282340	1	19,05	495
SB197.000.075	7314150282524	1	6,88	496
SB197.001.080	7314150282531	1	8,34	496
SB197.002.100	7314150282548	1	10,52	496
SB197.003.150	7314150282555	1	13,29	496
SB197.004.200	7314150282562	1	19,29	496
SB198.040.125	7314150282982	1	10,28	207
SB198.045.125	7314150282999	1	10,28	207
SB198.050.150	7314150283002	1	10,83	207
SB198.055.150	7314150283019	1	10,83	207
SB198.060.150F	7314150283026	1	11,27	207
SB198.060.150F	7314150283033	1	16,10	207
SB198.070.150	7314150283040	1	11,80	207



SB198.070.150F	7314150283057	1	16,59	207
SB198.080.150	7314150283064	1	14,04	207
SB198.080.150F	7314150283071	1	17,66	207
SB198.090.150	7314150283088	1	14,31	207
SB198.100.150	7314150283095	1	14,71	207
SB198.110.150	7314150283101	1	15,10	207
SB198.120.150	7314150283118	1	16,96	207
SB198.130.150	7314150283125	1	17,46	207
SB198.140.150	7314150283132	1	18,91	207
SB199.055.125	7314150283149	1	12,04	496
SB199.060.125	7314150283156	1	13,04	496
SB199.070.125	7314150283163	1	13,91	496
SB199.080.125	7314150283170	1	15,29	496
SB199.090.125	7314150283187	1	16,94	496
SB199.100.125	7314150283194	1	18,63	496
SB199.110.125	7314150283200	1	20,29	496
SB199.120.125	7314150287765	1	22,57	496
SB199.130.125	7314150287796	1	24,97	496
SB2446-EL	7314150312207	10	9,72	584
SB2446-LAP	7314150539475	10	10,30	583
SB27M-10-11	7314150180851	10	15,39	58
SB27M-12-13	7314150180868	10	18,00	58
SB27M-14-15	7314150180875	10	19,95	58
SB27M-16-17	7314150180882	10	22,99	58
SB27M-18-19	7314150180899	10	27,22	58
SB27M-20-22	7314150180905	10	30,84	58
SB27M-21-23	7314150180912	5	34,18	58
SB27M-24-26	7314150180929	5	37,94	58
SB27M-6-7	7314150180837	10	14,42	58
SB27M-8-9	7314150180844	10	14,56	58
SB28M-10	7314150485987	10	13,79	56
SB28M-11	7314150486007	10	14,54	56
SB28M-12	7314150486021	10	15,39	56
SB28M-13	7314150486045	10	16,26	56
SB28M-14	7314150486052	10	19,05	56
SB28M-15	7314150486076	10	20,13	56
SB28M-16	7314150486090	5	21,20	56
SB28M-17	7314150486113	5	21,37	56
SB28M-18	7314150486137	5	26,43	56
SB28M-19	7314150486151	5	27,86	56
SB28M-20	7314150486854	4	29,79	56
SB28M-21	7314150486878	4	32,32	56
SB28M-22	7314150486892	4	37,45	56
SB28M-23	7314150486915	4	38,94	56
SB28M-24	7314150486939	4	41,23	56
SB28M-6	7314150486175	10	11,65	56
SB28M-7	7314150486199	10	12,10	56
SB28M-8	7314150486212	10	12,65	56
SB28M-9	7314150486236	10	13,10	56
SB3654BM-15	7314150270897	5	13,96	610
SB3654BM-20	7314150270903	5	14,83	610
SB3734BM-10	7314150271092	5	14,52	610
SB3734BM-3	7314150270996	5	12,68	610
SB3734BM-4	7314150271016	5	13,03	610
SB3734BM-5	7314150271030	5	13,43	610
SB3734BM-6	7314150271054	5	13,84	610
SB3734BM-8	7314150271078	5	14,10	610
SB3755BM-4	7314150270934	1	10,29	610
SB3755BM-6	7314150270958	5	11,45	610
SB6700SM-10	7314150104383	1	5,84	78
SB6700SM-11	7314150104390	1	5,84	78
SB6700SM-12	7314150104406	1	5,84	78
SB6700SM-13	7314150104413	1	5,84	78
SB6700SM-14	7314150104420	1	5,84	78
SB6700SM-4	7314150104307	1	5,84	78
SB6700SM-4.5	7314150104314	1	5,84	78
SB6700SM-5	7314150104321	1	5,84	78
SB6700SM-5.5	7314150104338	1	5,84	78
SB6700SM-6	7314150104345	1	5,84	78
SB6700SM-7	7314150104352	1	5,84	78
SB6700SM-8	7314150104369	1	5,84	78
SB6700SM-9	7314150104376	1	5,84	78
SB6700SZ-1/2	7314150240609	1	5,89	78
SB6700SZ-1/4	7314150240616	1	5,89	78
SB6700SZ-1/8	7314150412495	5	5,89	78
SB6700SZ-11/32	7314150240623	1	5,89	78
SB6700SZ-3/16	7314150240630	1	5,89	78
SB6700SZ-3/8	7314150240647	1	5,89	78
SB6700SZ-5/16	7314150240654	1	5,89	78
SB6700SZ-5/32	7314150240661	1	5,89	78
SB6700SZ-7/16	7314150240678	1	5,89	78
SB6700SZ-7/32	7314150240685	1	5,89	78
SB6700SZ-9/16	7314150240692	1	5,89	78
SB6700SZ-9/32	7314150240708	1	5,89	78
SB6700TORX-E10	7314150240715	1	7,55	78
SB6700TORX-E4	7314150240722	1	7,55	78
SB6700TORX-E5	7314150240739	1	7,55	78
SB6700TORX-E6	7314150240746	1	7,55	78
SB6700TORX-E7	7314150240753	1	7,55	78
SB6700TORX-E8	7314150240760	1	7,55	78
SB6709F-4.5	7314150240777	1	7,51	82
SB6709F-5.5	7314150240784	1	7,51	82
SB6709F-6.5	7314150240791	1	7,52	82
SB6709F-8	7314150240807	1	7,51	82
SB67M-3	7314150290055	1	3,50	83
SB6709M-4	7314150240821	1	7,41	83



SB6709M-5	7314150240838	1	7,41	83
SB6709M-6	7314150240845	1	7,41	83
SB6709M-8	7314150240852	1	7,41	83
SB6709PH-1	7314150240869	1	8,14	82
SB6709PH-2	7314150240876	1	8,14	82
SB6709PH-3	7314150240883	1	8,14	82
SB6709PZ-1	7314150240890	1	8,58	83
SB6709PZ-2	7314150240906	1	8,58	83
SB6709PZ-3	7314150240913	1	8,58	83
SB6709TORX-R-T10	7314150240975	1	9,46	83
SB6709TORX-R-T15	7314150240937	1	9,46	83
SB6709TORX-R-T20	7314150240944	1	9,46	83
SB6709TORX-R-T25	7314150240951	1	9,79	83
SB6709TORX-R-T8	7314150240968	1	9,46	83
SB6709TORX-T10	7314150240982	1	9,07	83
SB6709TORX-T15	7314150240999	1	9,07	83
SB6709TORX-T20	7314150241002	1	9,07	83
SB6709TORX-T25	7314150241019	1	9,33	83
SB6709TORX-T27	7314150241026	1	9,33	83
SB6709TORX-T30	7314150241033	1	9,33	83
SB6709TORX-T40	7314150241040	1	9,33	83
SB6709TORX-T8	7314150241057	1	9,07	83
SB6709TORX-T9	7314150241064	1	9,07	83
SB6950	7314150104987	1	41,54	84
SB6950RN	7314150104994	1	37,63	84
SB6954-5	7314150521188	10	12,31	80
SB6956	7314150241071	1	12,70	80
SB6958-6	7314150500833	1	43,05	80
SB6960	7314150104925	1	10,31	81
SB6960-3	7314150512225	1	12,23	81
SB6961	7314150104932	1	11,83	81
SB6962	7314150104949	1	13,93	81
SB6962L	7314150254743	1	30,54	81
SB6963	7314150241088	1	20,58	81
SB6966	7314150241095	1	24,31	81
SB6973A	7314150507214	1	5,85	82
SB6M-10-11	7314150105731	1	7,97	48
SB6M-12-13	7314150105762	1	9,08	48
SB6M-14-15	7314150105823	1	9,54	48
SB6M-16-17	7314150105847	1	10,57	48
SB6M-17-19	7314150189830	1	11,22	48
SB6M-18-19	7314150105878	1	11,34	48
SB6M-20-22	7314150105915	1	13,60	48
SB6M-21-23	7314150105922	1	14,71	48
SB6M-22-24	7314150105946	1	14,11	48
SB6M-24-26	7314150105953	1	16,72	48
SB6M-24-27	7314150105960	1	17,02	48
SB6M-25-28	7314150189847	1	18,10	48
SB6M-27-29	7314150189854	1	22,00	48
SB6M-30-32	7314150106011	1	24,56	48
SB6M-4-5	7314150106042	1	9,59	48
SB6M-6-7	7314150106073	1	8,06	48
SB6M-8-9	7314150106103	1	7,50	48
SB705.1/4.125	7314150283231	1	12,73	216
SB7400SM-10	7314150241101	1	6,79	85
SB7400SM-11	7314150241118	1	6,87	85
SB7400SM-12	7314150241125	1	6,98	85
SB7400SM-13	7314150241132	1	7,12	85
SB7400SM-14	7314150241149	1	7,56	85
SB7400SM-15	7314150241156	1	7,85	85
SB7400SM-16	7314150241170	1	8,23	85
SB7400SM-17	7314150241187	1	8,40	85
SB7400SM-18	7314150241194	1	8,60	85
SB7400SM-19	7314150241200	1	8,93	85
SB7400SM-20	7314150241217	1	9,14	85
SB7400SM-21	7314150241224	1	9,38	85
SB7400SM-22	7314150241231	1	9,53	85
SB7400SM-6	7314150241248	1	6,26	85
SB7400SM-7	7314150241255	1	6,26	85
SB7400SM-8	7314150241262	1	6,36	85
SB7400SM-9	7314150241279	1	6,58	85
SB7400TORX-E10	7314150241286	1	11,57	86
SB7400TORX-E11	7314150241293	1	11,57	86
SB7400TORX-E12	7314150241309	1	11,57	86
SB7400TORX-E14	7314150241316	1	12,56	86
SB7400TORX-E16	7314150241323	1	12,56	86
SB7400TORX-E18	7314150241330	1	13,15	86
SB7400TORX-E8	7314150241347	1	11,57	86
SB7409BH-10	7314150241354	1	14,68	90
SB7409BH-4	7314150241361	1	12,06	90
SB7409BH-5	7314150241378	1	12,06	90
SB7409BH-6	7314150241385	1	12,06	90
SB7409BH-8	7314150241392	1	13,03	90
SB7409F-10	7314150241408	1	7,24	89
SB7409F-6.5	7314150241415	1	7,24	89
SB7409F-8	7314150241422	1	7,24	89
SB7409M-10	7314150241439	1	12,29	90
SB7409M-3	7314150241446	1	11,29	90
SB7409M-4	7314150241453	1	11,29	90
SB7409M-5	7314150241460	1	11,29	90
SB7409M-6	7314150241477	1	11,29	90
SB7409M-7	7314150241484	1	11,29	90
SB7409M-8	7314150241491	1	12,29	90
SB7409PH-1	7314150241507	1	7,56	89
SB7409PH-2	7314150241514	1	7,56	89
SB7409PH-3	7314150241521	1	7,56	89



SB7409TORX-R-T27



SB7409TORX-R-T27	7314150241538	1	13,68	89
SB7409TORX-R-T30	7314150241545	1	13,68	89
SB7409TORX-R-T40	7314150241552	1	15,98	89
SB7409TORX-R-T45	7314150241569	1	16,25	89
SB7409TORX-R-T50	7314150241576	1	16,93	89
SB7409TORX-T20	7314150241583	1	12,40	89
SB7409TORX-T25	7314150241590	1	12,40	89
SB7409TORX-T25-L	7314150241606	1	19,73	90
SB7409TORX-T27	7314150241613	1	12,40	89
SB7409TORX-T30	7314150241620	1	12,40	89
SB7409TORX-T30-L	7314150241637	1	19,73	90
SB7409TORX-T40	7314150241644	1	14,86	89
SB7409TORX-T40-L	7314150241651	1	22,94	90
SB7409TORX-T45	7314150241668	1	14,86	89
SB7409TORX-T45-L	7314150241675	1	22,94	90
SB7409TORX-T50	7314150241682	1	14,86	89
SB7409TORX-T50-L	7314150241699	1	22,94	90
SB7750	7314150187850	1	58,94	88
SB7750RNR	7314153003966	1	53,14	88
SB7754	7314150250165	1	18,77	87
SB7756	7314150489176	1	18,93	87
SB7758-10	7314150500840	1	30,48	87
SB7759	7314150254859	1	41,27	87
SB7760	7314153003980	1	13,72	87
SB7761	7314150241705	1	16,19	87
SB7762	7314153004000	1	19,90	87
SB7764	7314150241729	1	12,97	88
SB7765	7314150241736	50	10,38	81
SB7766	7314150241743	1	30,00	87
SB7767	7314150254897	1	24,85	82
SB7773A	7314150516209	1	2,32	88
SB7800DM-10	7314150104451	1	7,58	92
SB7800DM-11	7314150104468	1	7,69	92
SB7800DM-12	7314150104475	1	8,06	92
SB7800DM-13	7314150104482	1	8,36	92
SB7800DM-14	7314150104499	1	8,73	92
SB7800DM-15	7314150104505	1	9,01	92
SB7800DM-16	7314150104512	1	9,18	92
SB7800DM-17	7314150104529	1	9,50	92
SB7800DM-18	7314150104536	1	9,50	92
SB7800DM-19	7314150104543	1	9,82	92
SB7800DM-20	7314150104550	1	10,05	92
SB7800DM-21	7314150104567	1	10,29	92
SB7800DM-22	7314150104574	1	10,60	92
SB7800DM-23	7314150104581	1	11,10	92
SB7800DM-24	7314150104598	1	11,81	92
SB7800DM-25	7314150104604	1	11,98	92
SB7800DM-26	7314150104611	1	12,20	92
SB7800DM-27	7314150104628	1	12,53	92
SB7800DM-28	7314150104635	1	13,35	92
SB7800DM-29	7314150104642	1	13,66	92
SB7800DM-30	7314150104659	1	13,81	92
SB7800DM-31	7314150471171	1	14,17	92
SB7800DM-32	7314150104666	1	14,32	92
SB7800DM-33	7314150240319	1	12,22	92
SB7800DM-34	7314150327607	1	17,16	92
SB7800DM-36	7314150104673	1	26,12	92
SB7800DM-8	7314150104437	1	7,58	92
SB7800DM-9	7314150104444	1	7,58	92
SB7800DZ-1	7314150234912	1	11,72	92
SB7800DZ-1.1/16	7314150240326	1	12,37	92
SB7800DZ-1.1/4	7314150240333	1	13,96	92
SB7800DZ-1.1/8	7314150240340	1	13,08	92
SB7800DZ-1.3/16	7314150240357	1	13,82	92
SB7800DZ-1.5/16	7314150240364	1	13,74	92
SB7800DZ-1/2	7314150234899	1	8,07	92
SB7800DZ-11/16	7314150234929	1	9,25	92
SB7800DZ-13/16	7314150234936	1	10,13	92
SB7800DZ-15/16	7314150234943	1	11,65	92
SB7800DZ-19/32	7314150240371	1	8,78	92
SB7800DZ-25/32	7314150240388	1	9,81	92
SB7800DZ-3/4	7314150234950	1	9,65	92
SB7800DZ-3/8	7314150234967	1	7,25	92
SB7800DZ-5/8	7314150234974	1	9,01	92
SB7800DZ-7/16	7314150234981	1	7,40	92
SB7800DZ-7/8	7314150234998	1	10,44	92
SB7800DZ-9/16	7314150235001	1	8,55	92
SB7800SM-10	7314150104703	1	7,72	91
SB7800SM-11	7314150104710	1	7,72	91
SB7800SM-12	7314150104727	1	8,06	91
SB7800SM-13	7314150104734	1	8,36	91
SB7800SM-14	7314150104741	1	8,73	91
SB7800SM-15	7314150104758	1	9,01	91
SB7800SM-16	7314150104765	1	9,18	91
SB7800SM-17	7314150104772	1	9,50	91
SB7800SM-18	7314150104789	1	9,50	91
SB7800SM-19	7314150104796	1	9,82	91
SB7800SM-20	7314150240395	1	9,77	91
SB7800SM-21	7314150104819	1	10,29	91
SB7800SM-22	7314150104826	1	10,60	91
SB7800SM-23	7314150104833	1	11,10	91
SB7800SM-24	7314150104840	1	11,81	91
SB7800SM-25	7314150104857	1	11,98	91
SB7800SM-26	7314150104864	1	12,20	91
SB7800SM-27	7314150104871	1	12,53	91
SB7800SM-28	7314150104888	1	13,35	91



SB7800SM-29	7314150240401	1	13,35	91
SB7800SM-30	7314150104895	1	13,81	91
SB7800SM-32	7314150104901	1	14,08	91
SB7800SM-33	7314150240418	1	13,59	91
SB7800SM-34	7314150235018	1	17,93	91
SB7800SM-36	7314150235025	1	25,12	91
SB7800SM-8	7314150104680	1	7,58	91
SB7800SM-9	7314150104697	1	7,72	91
SB7800TORX-E10	7314150240104	1	11,10	93
SB7800TORX-E11	7314150240111	1	11,10	93
SB7800TORX-E12	7314150240128	1	11,10	93
SB7800TORX-E14	7314150240135	1	11,10	93
SB7800TORX-E16	7314150240142	1	11,24	93
SB7800TORX-E18	7314150240159	1	11,24	93
SB7800TORX-E20	7314150240166	1	11,81	93
SB7800TORX-E24	7314150240173	1	12,92	93
SB7800TORX-E8	7314150240180	1	9,93	93
SB7805DM-10	7314150234851	1	17,84	92
SB7805DM-12	7314150234868	1	17,84	92
SB7805DM-13	7314150235032	1	17,84	92
SB7805DM-14	7314150235049	1	18,59	92
SB7805DM-15	7314150235056	1	19,51	92
SB7805DM-16	7314150235063	1	20,06	92
SB7805DM-17	7314150235070	1	20,06	92
SB7805DM-18	7314150235087	1	20,06	92
SB7805DM-19	7314150235094	1	20,06	92
SB7805DM-21	7314150235100	1	22,20	92
SB7805DM-22	7314150235117	1	22,39	92
SB7805DM-23	7314150327614	1	22,44	92
SB7805DM-24	7314150235124	1	23,06	93
SB7805DM-26	7314150240197	1	23,06	93
SB7805DM-27	7314150235131	1	25,49	93
SB7805DM-30	7314150235148	1	27,22	93
SB7805DM-32	7314150240203	1	27,83	93
SB7805DM-34	7314150521852	1	21,68	93
SB7805SM-10	7314150235155	1	18,14	91
SB7805SM-11	7314150524501	1	12,51	91
SB7805SM-12	7314150235162	1	18,14	91
SB7805SM-13	7314150235179	1	18,14	91
SB7805SM-14	7314150235193	1	18,88	91
SB7805SM-15	7314150235216	1	19,85	91
SB7805SM-16	7314150240210	1	20,34	91
SB7805SM-17	7314150235223	1	20,34	91
SB7805SM-18	7314150235230	1	20,34	91
SB7805SM-19	7314150235247	1	20,34	91
SB7805SM-20	7314150240227	1	21,07	91
SB7805SM-21	7314150235254	1	22,60	91
SB7805SM-22	7314150235261	1	22,78	91
SB7805SM-23	7314150240234	1	23,47	91
SB7805SM-24	7314150235278	1	23,47	91
SB7805SM-25	7314150240241	1	23,47	91
SB7805SM-26	7314150240258	1	23,47	91
SB7805SM-27	7314150235285	1	25,89	91
SB7805SM-28	7314150240265	1	24,17	91
SB7805SM-29	7314150240272	1	25,82	91
SB7805SM-30	7314150235292	1	27,66	91
SB7805SM-32	7314150235308	1	29,89	91
SB7805SM-34	7314150498284	1	32,67	91
SB7807H	7314150467297	1	47,20	177
SB7808H	7314150467303	1	47,20	177
SB7809H	7314150467341	1	52,27	177
SB7809M-10	7314153004185	1	15,25	96
SB7809M-12	7314153004208	1	15,58	96
SB7809M-14	7314153004215	1	15,97	96
SB7809M-17	7314153004222	1	16,48	96
SB7809M-19	7314153004239	1	16,73	96
SB7809M-4	7314150313952	1	14,17	96
SB7809M-5	7314153004109	1	14,17	96
SB7809M-5-180	7314153004116	1	22,64	96
SB7809M-6	7314153004123	1	14,17	96
SB7809M-7	7314153004130	1	14,17	96
SB7809M-7-100	7314153004147	1	18,24	96
SB7809M-8	7314153004154	1	15,25	96
SB7809M-8-120	7314153004161	1	20,82	96
SB7809M-9	7314153004178	1	15,25	96
SB7809TORX-T20	7314153004017	1	15,90	95
SB7809TORX-T25	7314153004024	1	15,90	95
SB7809TORX-T27	7314153004031	1	15,90	95
SB7809TORX-T30	7314153004048	1	15,90	95
SB7809TORX-T40	7314153004055	1	18,39	95
SB7809TORX-T45	7314153004062	1	18,39	95
SB7809TORX-T50	7314153004079	1	18,39	95
SB7809TORX-T55	7314153004086	1	22,74	95
SB7809TORX-T60	7314153004093	1	22,74	95
SB8150-1/2	7314150105014	1	65,66	97
SB8150RN-1/2	7314150105007	1	63,43	97
SB8154-11	7314150472178	1	24,01	93
SB8157-10	7314150474073	1	95,73	93
SB8157-15	7314150472468	1	56,16	93
SB8157-24	7314150474080	1	96,78	93
SB8157-36	7314150474097	1	133,82	93
SB8158-10	7314150488780	1	34,69	93
SB8158-15	7314150488797	1	44,22	93
SB8160-10	7314150472185	1	19,85	93
SB8160-3	7314150472192	1	16,42	93
SB8160-5	7314150472208	1	11,07	93

			€	
SB8166	7314150472154	1	35,75	94
SB8171	7314150479016	1	19,85	94
SB8172	7314150479023	1	23,33	94
SBA6700DM-10	7314150235575	1	5,80	79
SBA6700DM-11	7314150241750	1	5,80	79
SBA6700DM-12	7314150241767	1	5,80	79
SBA6700DM-13	7314150241774	1	5,80	79
SBA6700DM-14	7314150241781	1	5,80	79
SBA6700DM-5	7314150255054	1	5,80	79
SBA6700DM-5.5	7314150241798	1	5,80	79
SBA6700DM-6	7314150241804	1	5,80	79
SBA6700DM-7	7314150241811	1	5,80	79
SBA6700DM-8	7314150241828	1	5,80	79
SBA6700DM-9	7314150241835	1	5,80	79
SBA6700DZ-1/2	7314150241842	1	7,25	79
SBA6700DZ-1/4	7314150241859	1	7,16	79
SBA6700DZ-11/32	7314150241866	1	7,16	79
SBA6700DZ-3/16	7314150241873	1	7,16	79
SBA6700DZ-3/8	7314150241880	1	7,25	79
SBA6700DZ-5/16	7314150241897	1	7,16	79
SBA6700DZ-7/16	7314150241903	1	7,25	79
SBA6700DZ-7/32	7314150241910	1	7,16	79
SBA6700DZ-9/16	7314150241927	1	7,25	79
SBA6700DZ-9/32	7314150241934	1	7,16	79
SBA6709M-2.5	7314150254835	1	32,79	83
SBA6709M-3	7314150254828	1	32,79	83
SBA6709M-4	7314150254811	1	32,79	83
SBA6709M-5	7314150254804	1	32,62	83
SBA6709M-6	7314150254798	1	32,62	83
SBA6709Z-1/8	7314150254781	1	32,62	83
SBA6709Z-3/16	7314150254774	1	32,62	83
SBA6709Z-5/32	7314150254767	1	32,62	83
SBA6709Z-9/64	7314150254750	1	32,62	83
SBA6800DM-10	7314150250172	1	12,73	79
SBA6800DM-11	7314150250189	1	12,73	79
SBA6800DM-12	7314150250196	1	12,73	79
SBA6800DM-13	7314150250202	1	12,73	79
SBA6800DM-14	7314150250219	1	12,73	79
SBA6800DM-4	7314150250226	1	12,73	79
SBA6800DM-5	7314150250233	1	12,73	79
SBA6800DM-5.5	7314150250240	1	12,73	79
SBA6800DM-6	7314150250257	1	12,73	79
SBA6800DM-7	7314150250264	1	12,73	79
SBA6800DM-8	7314150250271	1	12,73	79
SBA6800DM-9	7314150250288	1	12,73	79
SBA6800DZ-1/2	7314150250295	1	15,23	80
SBA6800DZ-1/4	7314150250301	1	15,23	80
SBA6800DZ-11/32	7314150250318	1	15,23	80
SBA6800DZ-3/16	7314150250325	1	15,23	80
SBA6800DZ-3/8	7314150250332	1	15,23	80
SBA6800DZ-5/16	7314150250349	1	15,23	80
SBA6800DZ-7/16	7314150250356	1	15,23	80
SBA6800DZ-7/32	7314150250363	1	15,23	80
SBA6800DZ-9/16	7314150250370	1	15,23	80
SBA6800DZ-9/32	7314150250387	1	15,23	80
SBA7400DM-10	7314150241941	1	8,11	85
SBA7400DM-11	7314150241958	1	8,11	85
SBA7400DM-12	7314150241965	1	8,11	85
SBA7400DM-13	7314150241972	1	8,11	85
SBA7400DM-14	7314150241989	1	8,11	85
SBA7400DM-15	7314150241996	1	8,22	85
SBA7400DM-16	7314150242009	1	8,22	85
SBA7400DM-17	7314150242016	1	8,22	85
SBA7400DM-18	7314150242023	1	8,22	85
SBA7400DM-19	7314150242030	1	8,22	85
SBA7400DM-20	7314150242047	1	8,22	85
SBA7400DM-21	7314150242054	1	8,31	85
SBA7400DM-22	7314150242061	1	8,31	85
SBA7400DM-6	7314150242078	1	8,11	85
SBA7400DM-7	7314150242085	1	8,11	85
SBA7400DM-8	7314150242092	1	8,11	85
SBA7400DM-9	7314150242108	1	8,11	85
SBA7400DZ-1/2	7314150254705	1	8,93	86
SBA7400DZ-1/4	7314150242115	1	8,79	86
SBA7400DZ-11/16	7314150242122	1	9,04	86
SBA7400DZ-13/16	7314150242139	1	9,04	86
SBA7400DZ-17/32	7314150242146	1	8,93	86
SBA7400DZ-19/32	7314150242153	1	8,93	86
SBA7400DZ-3/4	7314150242160	1	9,04	86
SBA7400DZ-3/8	7314150242177	1	8,79	86
SBA7400DZ-5/16	7314150242184	1	8,79	86
SBA7400DZ-5/8	7314150242191	1	9,04	86
SBA7400DZ-7/16	7314150242207	1	8,93	86
SBA7400DZ-7/8	7314150242214	1	9,04	86
SBA7400DZ-9/16	7314150242221	1	8,93	86
SBA7402DM-10	7314150250394	1	15,60	86
SBA7402DM-11	7314150250400	1	15,60	86
SBA7402DM-12	7314150250417	1	15,60	86
SBA7402DM-13	7314150250424	1	15,60	86
SBA7402DM-14	7314150250431	1	16,27	86
SBA7402DM-15	7314150250448	1	16,27	86
SBA7402DM-16	7314150250455	1	16,27	86
SBA7402DM-17	7314150250462	1	17,33	86
SBA7402DM-18	7314150250479	1	17,33	86
SBA7402DM-19	7314150250486	1	17,33	86
SBA7402DM-7	7314150250493	1	15,58	86

			€	
SBA7402DM-8	7314150250509	1	15,58	86
SBA7402DM-9	7314150250516	1	15,60	86
SBA7402DZ-1/2	7314150250523	1	17,41	86
SBA7402DZ-1/4	7314150250530	1	17,41	86
SBA7402DZ-11/16	7314150250547	1	17,41	86
SBA7402DZ-13/16	7314150250554	1	17,41	86
SBA7402DZ-19/32	7314150250561	1	17,41	86
SBA7402DZ-3/4	7314150250578	1	17,41	86
SBA7402DZ-3/8	7314150250585	1	17,41	86
SBA7402DZ-5/16	7314150250592	1	17,41	86
SBA7402DZ-5/8	7314150250608	1	17,41	86
SBA7402DZ-7/16	7314150250615	1	17,41	86
SBA7402DZ-7/8	7314150250622	1	17,41	86
SBA7402DZ-9/16	7314150250639	1	17,41	86
SBC110-65	7314150456246	1	2,49	573
SBE-8135TB	7314150320424	1	9,15	199
SBE-8145TB	7314150320431	1	11,83	199
SBE-8150TB	7314150320448	1	13,59	199
SBE-8155TB	7314150320455	1	15,88	199
SBE-8610TB	7314150320493	1	14,45	199
SBE-8620TB	7314150320509	1	15,97	199
SBE-8810TB	7314150320530	1	13,02	199
SBE-8820TB	7314150320547	1	18,17	199
SBE-8915TB	7314150320585	1	11,50	200
SBE-8920TB	7314150320592	1	11,69	200
SBE-8925TB	7314150320608	1	12,39	200
SBE-8930TB	7314150320622	1	14,14	200
SBE-8940TB	7314150320639	1	15,89	200
SBK6701M-10	7314150445233	1	7,35	172
SBK6701M-11	7314150445240	1	7,35	172
SBK6701M-12	7314150445264	1	9,11	172
SBK6701M-13	7314150445271	1	9,11	172
SBK6701M-14	7314150445288	1	9,11	172
SBK6701M-6	7314150445196	1	7,35	172
SBK6701M-7	7314150445202	1	7,35	172
SBK6701M-8	7314150445219	1	7,35	172
SBK6701M-9	7314150445226	1	7,35	172
SBK7401M-10	7314150445325	1	8,41	173
SBK7401M-11	7314150445332	1	8,41	173
SBK7401M-12	7314150445349	1	8,41	173
SBK7401M-13	7314150445356	1	8,41	173
SBK7401M-14	7314150445363	1	8,41	173
SBK7401M-15	7314150445370	1	8,41	173
SBK7401M-16	7314150445387	1	8,41	173
SBK7401M-17	7314150445394	1	8,41	173
SBK7401M-18	7314150445400	1	9,88	173
SBK7401M-19	7314150445417	1	9,88	173
SBK7401M-20	7314150445424	1	10,17	173
SBK7401M-21	7314150445431	1	10,17	173
SBK7401M-22	7314150445448	1	10,62	173
SBK7401M-24	7314150445455	1	10,71	173
SBK7401M-7	7314150445295	1	8,41	173
SBK7401M-8	7314150445301	1	8,41	173
SBK7401M-9	7314150445318	1	8,41	173
SBK7764D	7314150447800	1	22,93	177
SBK7801M-10	7314150445486	1	10,05	175
SBK7801M-11	7314150445493	1	10,05	175
SBK7801M-12	7314150445509	1	10,05	175
SBK7801M-13	7314150445516	1	10,05	175
SBK7801M-14	7314150445523	1	10,40	175
SBK7801M-15	7314150445530	1	10,40	175
SBK7801M-16	7314150445547	1	10,40	175
SBK7801M-17	7314150445554	1	11,38	175
SBK7801M-18	7314150445561	1	11,38	175
SBK7801M-19	7314150445578	1	11,38	175
SBK7801M-20	7314150445585	1	11,38	175
SBK7801M-21	7314150445592	1	11,38	175
SBK7801M-22	7314150445608	1	12,20	175
SBK7801M-23	7314150445615	1	12,24	175
SBK7801M-24	7314150445622	1	12,24	175
SBK7801M-25	7314150445639	1	12,24	175
SBK7801M-26	7314150445646	1	12,24	175
SBK7801M-27	7314150445653	1	15,20	175
SBK7801M-28	7314150450763	1	14,55	175
SBK7801M-29	7314150450770	1	14,63	175
SBK7801M-30	7314150445660	1	16,53	175
SBK7801M-32	7314150445677	1	23,69	175
SBK7801M-34	7314150445684	1	25,75	175
SBK7801M-36	7314150445691	1	25,75	175
SBK7801M-8	7314150445462	1	7,98	175
SBK7801M-9	7314150445479	1	7,98	175
SBK7801Z-1	7314150448036	1	13,93	176
SBK7801Z-1.1/16	7314150448142	1	15,02	176
SBK7801Z-1.1/2	7314150448203	1	34,69	176
SBK7801Z-1.1/4	7314150448166	1	26,17	176
SBK7801Z-1.1/8	7314150448159	1	15,92	176
SBK7801Z-1.3/8	7314150448180	1	30,28	176
SBK7801Z-1.5/16	7314150448173	1	30,28	176
SBK7801Z-1.7/16	7314150448197	1	30,28	176
SBK7801Z-1/2	7314150448067	1	11,00	176
SBK7801Z-11/16	7314150448098	1	11,36	176
SBK7801Z-13/16	7314150448111	1	11,52	176
SBK7801Z-15/16	7314150448135	1	13,40	176
SBK7801Z-3/4	7314150448104	1	11,36	176



SBK7801Z-3/8



SBK7801Z-3/8	7314150448043	1	11,00	176
SBK7801Z-5/8	7314150448081	1	11,36	176
SBK7801Z-7/16	7314150448050	1	11,00	176
SBK7801Z-7/8	7314150448128	1	11,52	176
SBK7801Z-9/16	7314150448074	1	11,36	176
SBK7806M-10	7314150447831	1	13,15	176
SBK7806M-11	7314150447862	1	13,15	176
SBK7806M-12	7314150447879	1	13,15	176
SBK7806M-13	7314150447886	1	13,15	176
SBK7806M-14	7314150447893	1	13,15	176
SBK7806M-15	7314150447909	1	13,30	176
SBK7806M-16	7314150447916	1	13,30	176
SBK7806M-17	7314150447923	1	13,30	176
SBK7806M-18	7314150447930	1	13,34	176
SBK7806M-19	7314150447947	1	13,34	176
SBK7806M-21	7314150447954	1	13,34	176
SBK7806M-22	7314150447961	1	13,34	176
SBK7806M-23	7314150447978	1	13,93	176
SBK7806M-24	7314150447985	1	13,75	176
SBK7806M-27	7314150447992	1	15,93	176
SBK7806M-30	7314150448005	1	17,94	176
SBK7806M-32	7314150448012	1	20,85	176
SBK7806M-36	7314150448029	1	24,04	176
SBK7806Z-1	7314150448401	1	16,39	177
SBK7806Z-1.1/16	7314150448418	1	17,46	177
SBK7806Z-1.1/2	7314150448470	1	39,96	177
SBK7806Z-1.1/4	7314150448432	1	30,10	177
SBK7806Z-1.1/8	7314150448425	5	19,67	177
SBK7806Z-1.3/8	7314150448456	5	34,86	177
SBK7806Z-1.5/16	7314150448449	1	34,86	177
SBK7806Z-1.7/16	7314150448463	5	34,86	177
SBK7806Z-1/2	7314150448326	10	14,40	176
SBK7806Z-11/16	7314150448357	1	14,55	176
SBK7806Z-13/16	7314150448371	1	14,60	176
SBK7806Z-15/16	7314150448395	1	15,05	177
SBK7806Z-3/4	7314150448364	1	14,60	176
SBK7806Z-3/8	7314150448302	10	14,40	176
SBK7806Z-5/8	7314150448340	5	14,55	176
SBK7806Z-7/16	7314150448319	10	14,40	176
SBK7806Z-7/8	7314150448388	1	14,60	176
SBK7806Z-9/16	7314150448333	10	14,40	176
SBK8160D-1	7314150447770	1	14,85	177
SBK8160D-2	7314150447787	1	18,10	177
SBK8160D-3	7314150447794	1	28,26	177
SBK8901M-17	7314150448487	1	17,61	179
SBK8901M-18	7314150448494	1	17,61	179
SBK8901M-19	7314150448500	1	17,33	179
SBK8901M-21	7314150448517	1	17,33	179
SBK8901M-22	7314150448524	1	17,33	179
SBK8901M-23	7314150448531	1	17,61	179
SBK8901M-24	7314150448548	1	17,33	179
SBK8901M-27	7314150448555	1	17,33	179
SBK8901M-28	7314150448562	1	17,71	179
SBK8901M-29	7314150448579	1	17,98	179
SBK8901M-30	7314150448586	1	18,35	179
SBK8901M-32	7314150448593	1	19,00	179
SBK8901M-33	7314150448609	1	19,98	179
SBK8901M-34	7314150448616	1	20,17	179
SBK8901M-36	7314150448623	1	21,19	179
SBK8901M-38	7314150448630	1	21,97	179
SBK8901M-41	7314150448647	1	24,62	179
SBK8901M-46	7314150448654	1	28,42	179
SBK8901M-50	7314150448661	1	33,09	179
SBK8901M-55	7314150448678	1	39,73	179
SBK8901M-60	7314150448685	1	44,96	179
SBK8964D	7314150447817	1	11,76	177
SBS19-TH10	7314150190072	1	5,70	90
SBS19-TH11	7314150190089	1	5,70	90
SBS19-TH12	7314150190096	1	5,70	90
SBS19-TH13	7314150190102	1	5,70	90
SBS19-TH14	7314150190119	1	5,88	90
SBS19-TH15	7314150190126	1	5,88	90
SBS19-TH16	7314150190133	1	5,88	90
SBS19-TH17	7314150190140	1	6,72	90
SBS19-TH18	7314150190157	1	6,72	90
SBS19-TH19	7314150190164	1	6,72	90
SBS19-TH21	7314150190256	1	7,39	90
SBS19-TH22	7314150190188	1	7,39	90
SBS19-TH24	7314150190195	1	7,95	90
SBS19-TH75	7314150190201	1	9,70	90
SBS20-12	7314153009166	1	6,92	41
SBS20-15	7314153009197	1	7,83	41
SBS20-16	7314153009203	1	8,38	41
SBS20-20	7314153009241	1	11,54	41
SBS20-9	7314153009135	1	5,83	41
SBS61	7314153009661	1	24,24	84
SBS61S	7314150179886	1	23,40	84
SBS750	7314153012883	10	33,63	89
SBS81	7314153009937	5	41,04	97



SBSL25	7314153015853	5	46,23	63
SC127	7314150121984	10	12,83	579
SC127S	7314150121991	10	13,24	579
SC127V	7314150121847	5	23,79	502
SC140	7314150122004	10	13,49	579
SC140C	7314150122011	10	14,14	579
SC150NG	7314150122028	10	18,74	579
SC150NGV	7314150121854	5	36,71	502
SC2RM-13-17	7314150265350	10	37,14	102
SC2RM-15-17	7314150265367	10	37,74	102
SC2RM-19-22	7314150181384	10	38,93	102
SC2RM-27-30	7314150265343	1	70,08	102
SC335M-17	7314150344314	1	10,17	52
SC335M-19	7314150344321	1	14,78	52
SC335M-22	7314150344338	1	19,95	52
SC335M-24	7314150344345	1	21,76	52
SC335M-27	7314150344352	1	29,65	52
SC335M-30	7314150344369	1	37,05	52
SC335M-32	7314150344376	1	37,96	52
SC335M-36	7314150344383	1	43,13	52
SC335M-41	7314150344390	1	58,34	52
SC335M-46	7314150344406	1	73,63	52
SCB140	7314150297351	10	26,53	579
SCB140G	7314150297368	10	29,12	579
SCRAPER-SET2	7311518228613	1	108,01	548
SE-15-24	7311518029838	5	8,38	633
SE-15-30	7311518029821	5	8,90	633
SE-15-30-23	7311518029845	5	8,98	633
SE-15-32	7311518249168	5	9,82	633
SE-15-36	7311518141202	5	10,45	633
SE-15-36-23	7311518258276	5	10,40	633
SE-16-21	7311518029807	5	8,53	633
SE-16-21-23	7311518273934	5	7,37	633
SH-407	7314150389827	1	4,50	596
SH-427-700	7314150349074	10	5,97	596
SH-428-700	7314150349081	10	8,62	596
SH-485W	7314150358021	1	9,27	594
SH-485W-PLATES	7314150358038	1	7,37	594
SH-486-493-495	7314150349098	10	5,97	596
SH-486F493F495F	7314150349104	10	8,62	596
SH-486W	7314150358014	1	8,68	595
SH-488-2000	7314150346912	10	13,01	596
SH-488-34	7314150349036	10	18,84	596
SH-488-56	7314150349043	10	20,57	596
SH-488F-2000	7314150346950	10	16,05	596
SH-488F-34	7314150349050	1	19,90	596
SH-488F-56	7314150349067	1	21,23	596
SH-491-34	7314150374298	12	18,27	596
SH-491-56	7314150374304	12	29,06	596
SH-FCP-860	7311518324421	1	33,63	601
SH-FCS-810	7311518140540	1	27,06	601
SH-FCS-860	7311518140557	1	31,07	601
SH-FGS-1.8-810	7311518327828	1	20,22	601
SH-FGS-600	7311518140649	1	21,44	601
SH-FGS-700	7311518140656	12	23,40	601
SH-FGS-800	7311518140663	1	27,87	601
SH-HFGPS-400FG	7311518282301	1	19,33	601
SH-HGPS-360	7311518140618	12	14,49	601
SH-HGPS-380	7311518140625	1	15,54	601
SH-HGPS-400	7311518207618	1	17,15	601
SH-HUS-380	7311518140502	1	15,54	601
SH-HUS-500	7311518140519	1	20,39	601
SH-HUS-650	7311518140526	1	23,05	601
SH-MCS-800	7311518140595	1	27,87	601
SH-MES-900	7311518140601	12	26,82	601
SH-MES-900FG	7311518282318	12	40,15	601
SH-MES-F-900	7311518141554	12	20,89	601
SH-PAGS-900	7311518327866	1	20,57	601
SH-PAGS-900FG	7311518326944	1	47,59	601
SH-SUS-800	7311518140809	12	27,87	601
SHARP-INS	7314150197897	100	10,80	566
SHARP-X	7311518264895	10	23,25	636
SHARP-X-DISP	7311518264901	1	697,29	636
SL24	7314150128389	1	43,21	64
SL25	7314153013422	20	42,83	63
SL25AF	7314150180141	20	42,83	64
SL25L	7314150256570	10	60,17	64
SL34	7314150409181	6	83,32	70
SL65	7314150444137	6	86,52	64
SLX 17	7314153015785	1	269,86	76
SLX 17AF	7314150137558	1	269,86	76
SLX17-CASE	7314150321254	1	51,47	102
SP120	7314150312474	1	26,80	95
SP120XL	7314150313594	1	12,76	95
SPAR-CASE-A4	7314150263523	1	19,31	102
SPAR-CASE-A6	7314150263547	1	13,62	102
SPAR-CASE-A7	7314150263554	1	12,95	102
SQZ-MINI	7314150186280	24	9,72	582
SQZ-MINI-BLADE	7314150190348	1	5,22	582



SQZ150003	7314153013477	6	24,11	580
SQZ150003-HSBL	7314153015389	6	14,36	581
SR1000-E	7314150302918	20	14,98	544
SR1000-MM	7314150302857	20	14,98	543
SR150-E	7314150302864	12	2,07	544
SR150-MM	7314150302819	12	2,07	543
SR200-E	7314150302871	12	2,71	544
SR200-MM	7314150302826	12	2,71	543
SR300-E	7314150302888	12	3,64	544
SR300-MM	7314150302833	12	3,64	543
SR600-E	7314150302901	20	7,12	544
SR600-MM	7314150302840	20	7,12	543
SS001-100	7314150404384	1	90,91	526
SS001-150	7314150404377	1	102,46	526
SS001-200	7314150404391	1	149,23	526
SS001-250	7314150404407	1	184,27	526
SS001-300	7314150404414	1	243,99	526
SS001-375	7314150404421	1	378,88	526
SS001-450	7314150404438	1	447,81	526
SS001-600	7314150404445	1	750,62	526
SS002-10	7314150404483	1	20,34	526
SS002-11	7314150404490	1	22,72	526
SS002-12	7314150404506	1	23,92	526
SS002-13	7314150404513	1	25,11	526
SS002-14	7314150404520	1	26,31	526
SS002-15	7314150404537	1	27,51	526
SS002-16	7314150404551	1	28,71	526
SS002-17	7314150404568	1	29,90	526
SS002-19	7314150404575	1	31,10	526
SS002-21	7314150404582	1	38,75	526
SS002-22	7314150404599	1	41,85	526
SS002-24	7314150404605	1	47,12	526
SS002-27	7314150404612	1	68,18	526
SS002-32	7314150404629	1	93,17	526
SS002-6	7314150404469	1	13,02	526
SS002-6-2	7314150407903	1	155,50	526
SS002-7	7314150445790	1	19,06	526
SS002-8	7314150404476	1	16,38	526
SS002-9-2	7314150407910	1	229,66	526
SS003-10	7314150404643	1	18,19	526
SS003-11	7314150404650	1	21,29	526
SS003-12	7314150404667	1	23,33	526
SS003-14	7314150404681	1	25,11	526
SS003-16	7314150404704	1	27,51	526
SS003-18	7314150404711	1	29,42	526
SS003-20	7314150404728	1	31,10	526
SS003-22	7314150404735	1	32,53	526
SS003-24	7314150404742	1	34,09	526
SS003-25	7314150404759	1	40,66	526
SS003-26	7314150404766	1	43,07	526
SS003-28	7314150404773	1	44,25	526
SS003-30	7314150404780	1	52,63	526
SS003-8	7314150404636	1	16,74	526
SS011-0507	7314150404797	1	26,99	526
SS011-0607	7314150404803	1	27,60	526
SS011-0809	7314150404810	1	28,36	526
SS011-0810	7314150404827	1	28,64	526
SS011-0911	7314150404834	1	30,41	526
SS011-1012	7314150404858	1	30,89	526
SS011-11-3	7314150419142	1	776,99	527
SS011-1214	7314150404865	1	33,74	526
SS011-1417	7314150404872	1	39,00	526
SS011-1618	7314150404889	1	43,76	526
SS011-1719	7314150404896	1	47,86	526
SS011-1722	7314150404902	1	63,68	526
SS011-2224	7314150404919	1	72,95	526
SS011-2427	7314150404926	1	92,64	526
SS011-2430	7314150404940	1	131,77	526
SS011-3032	7314150404957	1	159,59	526
SS011-9-3	7314150419135	1	614,76	526
SS210-10	7314150405343	1	23,17	527
SS210-11	7314150405350	1	25,75	527
SS210-12	7314150405367	1	29,12	527
SS210-13	7314150405374	1	31,06	527
SS210-14	7314150405381	1	32,23	527
SS210-4	7314150405268	1	13,33	527
SS210-4.5	7314150405275	1	13,33	527
SS210-5	7314150405282	1	13,33	527
SS210-5.5	7314150405299	1	13,33	527
SS210-6	7314150405305	1	16,05	527
SS210-7	7314150405312	1	17,48	527
SS210-8	7314150405329	1	19,54	527
SS210-9	7314150405336	1	21,87	527
SS220-10	7314150404995	1	35,59	527
SS220-11	7314150405008	1	37,53	527
SS220-12	7314150405022	1	40,12	527
SS220-13	7314150405039	1	41,41	527
SS220-14	7314150405053	1	43,36	527
SS220-15	7314150405060	1	46,59	527



SS220-16	7314150405077	1	48,54	527
SS220-17	7314150405084	1	50,47	527
SS220-18	7314150405091	1	53,06	527
SS220-19	7314150405114	1	55,65	527
SS220-20	7314150405121	1	58,24	527
SS220-21	7314150405138	1	59,54	527
SS220-22	7314150405145	1	60,82	527
SS220-23	7314150405152	1	66,00	527
SS220-24	7314150405176	1	69,89	527
SS220-25	7314150405183	1	73,77	527
SS220-26	7314150405190	1	84,12	527
SS220-27	7314150405206	1	86,71	527
SS220-28	7314150405213	1	93,18	527
SS220-29	7314150405220	1	97,06	527
SS220-30	7314150405237	1	102,25	527
SS220-31	7314150405244	1	112,59	527
SS220-32	7314150405251	1	112,59	527
SS220-8	7314150404964	1	33,01	527
SS220-9	7314150404988	1	34,29	527
SS224-17	7314150405398	1	72,47	527
SS224-19	7314150405404	1	75,07	527
SS224-22	7314150405411	1	81,53	527
SS224-24	7314150405428	1	91,88	527
SS224-27	7314150405435	1	97,06	527
SS224-30	7314150405442	1	112,59	527
SS224-32	7314150405459	1	128,13	527
SS224-34	7314150405466	1	141,07	527
SS224-36	7314150405473	1	148,84	527
SS224-41	7314150405480	1	174,72	527
SS224-46	7314150405497	1	207,07	527
SS224-50	7314150405503	1	231,66	527
SS224-55	7314150405510	1	330,02	527
SS224-60	7314150405527	1	386,96	527
SS224-65	7314150405534	1	491,79	527
SS234-16-100	7314150405572	1	51,77	527
SS234-16-200	7314150405589	1	84,12	527
SS234-16-250	7314150405602	1	97,06	527
SS234-24-100	7314150405619	1	112,59	527
SS234-24-200	7314150405626	1	122,94	527
SS234-24-250	7314150405633	1	169,20	527
SS236-08-80	7314150405718	1	61,78	527
SS236-16-80	7314150405701	1	84,12	527
SS236-24-110	7314150405725	1	148,84	527
SS238-08-250	7314150405657	1	113,89	527
SS238-16-250	7314150405640	1	115,18	527
SS238-24-350	7314150405664	1	161,77	527
SS242-08-200	7314150405558	1	148,84	527
SS242-16-245	7314150405541	1	155,30	528
SS242-24-320	7314150405565	1	304,14	528
SS243-08	7314150405688	1	54,97	527
SS243-16	7314150405671	1	128,86	527
SS243-24	7314150405695	1	326,50	527
SS324-1.5	7314150405732	2	4,21	528
SS324-10	7314150405824	1	12,91	528
SS324-2	7314150405749	2	4,21	528
SS324-2.5	7314150405756	2	4,21	528
SS324-3	7314150405763	1	4,52	528
SS324-4	7314150405770	1	4,95	528
SS324-5	7314150405787	1	6,03	528
SS324-6	7314150405794	1	6,68	528
SS324-8	7314150405817	1	10,44	528
SS325-10	7314150405886	1	11,31	529
SS325-12	7314150405879	1	13,99	529
SS325-2.5	7314150405909	2	5,39	529
SS325-3	7314150405862	2	5,39	529
SS325-3.5	7314150405923	2	7,18	529
SS325-4	7314150405848	1	5,92	529
SS325-4.5	7314150405930	1	9,57	529
SS325-5	7314150405893	1	6,46	529
SS325-6	7314150405855	1	8,61	529
SS325-7	7314150405916	1	9,16	529
SS325-8	7314150405831	1	9,69	529
SS400-160	7314150405978	1	59,93	529
SS400-180	7314150405985	1	75,07	529
SS400-200	7314150405992	1	95,77	529
SS402-160	7314150406005	1	64,32	530
SS402-200	7314150406012	1	70,02	530
SS406-160	7314150406029	1	64,71	530
SS406-200	7314150406036	1	74,68	530
SS410-250	7314150406043	1	99,65	530
SS410-300	7314150406050	1	155,30	530
SS412-200	7314150406067	1	97,06	530
SS415-225	7314150406074	1	148,84	530
SS502-1000-FB	7314150406081	1	110,01	530
SS502-1500-FB	7314150406098	1	155,30	530
SS502-2000-FB	7314150406104	1	199,31	530
SS502-2500-FB	7314150406111	1	251,07	530
SS502-3000-FB	7314150406128	1	297,66	530
SS502-3600-FB	7314150406135	1	355,90	530



SS506-1100-FB



SS506-1100-FB	7314150406197	1	128,13	530
SS506-200-FB	7314150406142	1	37,53	530
SS506-300-FB	7314150406159	1	50,47	530
SS506-500-FB	7314150406166	1	54,36	530
SS506-700-FB	7314150406173	1	97,06	530
SS506-900-FB	7314150406180	1	112,59	530
SS603-15-500	7314150406203	1	80,24	530
SS603-19-500	7314150406210	1	111,30	530
SS603-20-500	7314150406227	1	114,42	530
SS603-23-500	7314150406234	1	134,66	530
SS603-23-800	7314150406258	1	207,07	530
SS603-25-600	7314150406241	1	195,57	530
SS603-30-1000	7314150406265	1	452,96	530
SS610-16-160	7314150406272	1	38,83	530
SS610-18-200	7314150406289	1	56,30	530
SS610-24-300	7314150406296	1	176,01	530
SS610-25-400	7314150406302	1	275,66	530
SS610-30-500	7314150406319	1	372,73	530
SUP-20-LAM	7311518258351	4	56,65	563
SUS-2.0-800	7311518123451	4	83,51	600
SW65	7314150442898	6	92,70	64
SW79	7314150442904	4	175,10	63
SW91	7314150442942	4	190,55	63
TAH08-10	7314150305087	1	6,47	477
TAH08-11	7314150305094	1	6,47	477
TAH08-12	7314150305100	1	6,47	477
TAH08-13	7314150305117	1	6,47	477
TAH08-5.5	7314150305032	1	6,47	477
TAH08-6	7314150305049	1	6,47	477
TAH08-7	7314150305056	1	6,47	477
TAH08-8	7314150305063	1	6,47	477
TAH08-9	7314150305070	1	6,47	477
TAH08-H3	7314150305124	1	8,50	477
TAH08-H4	7314150305131	1	8,50	477
TAH08-H5	7314150305148	1	8,50	477
TAH08-H6	7314150305155	1	8,50	477
TAH08-H8	7314150305162	1	8,50	477
TAH08-PH1	7314150305179	1	9,40	477
TAH08-PH2	7314150305186	1	9,40	477
TAH08-PH3	7314150305193	1	9,40	477
TAH08-T10	7314150305223	1	10,58	478
TAH08-T15	7314150305230	1	10,58	478
TAH08-T20	7314150305247	1	10,58	478
TAH08-T25	7314150305254	1	10,93	478
TAH08-T27	7314150305261	1	10,93	478
TAH08-T30	7314150305278	1	10,93	478
TAH08-T40	7314150305285	1	10,93	478
TAH08-T8	7314150305209	1	10,58	478
TAH08-T9	7314150305216	1	10,58	478
TAH1-100-06-2-4	7314150307531	1	19,95	485
TAH1-110-08-1-2	7314150437825	1	22,08	485
TAH1-143-12-1-2	7314150307548	1	25,53	485
TAH1-160-08-1-2	7314150437818	1	19,80	485
TAH1-170-08-1-2	7314150437801	1	20,66	485
TAH1-210-06-2-2	7314150307555	1	23,01	485
TAH1-210-08-1-2	7314150437795	1	24,41	485
TAH1-230-06-2-2	7314150307562	1	12,57	485
TAH1-230-08-1-2	7314150437788	1	25,84	485
TAH111M-10	7314150308538	1	14,33	475
TAH111M-11	7314150308545	1	14,56	475
TAH111M-12	7314150308552	1	14,97	475
TAH111M-13	7314150308569	1	15,00	475
TAH111M-14	7314150308576	1	15,05	475
TAH111M-15	7314150308583	1	15,56	475
TAH111M-16	7314150308590	1	15,85	475
TAH111M-17	7314150308606	1	16,97	475
TAH111M-18	7314150308613	1	18,80	475
TAH111M-19	7314150308620	1	19,61	475
TAH111M-20	7314150308637	1	20,17	475
TAH111M-21	7314150308644	1	21,82	475
TAH111M-22	7314150308651	1	21,99	475
TAH111M-23	7314150308668	1	23,29	475
TAH111M-24	7314150308675	1	24,37	475
TAH111M-25	7314150399611	1	27,37	475
TAH111M-27	7314150308682	1	34,47	475
TAH111M-30	7314150308699	1	42,00	475
TAH111M-32	7314150308705	1	45,29	475
TAH111M-34	7314150308712	1	52,42	475
TAH111M-36	7314150308729	1	74,07	475
TAH111M-41	7314150308736	1	94,06	475
TAH111M-46	7314150308743	1	123,99	475
TAH111M-50	7314150308750	1	140,46	475
TAH111M-55	7314150411573	1	228,79	475
TAH111M-6	7314150308491	1	14,18	475
TAH111M-7	7314150308507	1	14,21	475
TAH111M-8	7314150308514	1	14,24	475
TAH111M-9	7314150308521	1	14,29	475
TAH111Z-1	7314150343362	1	33,48	475
TAH111Z-1.1/16	7314150343379	1	34,82	475



TAH111Z-1.1/2	7314150431830	1	72,51	475
TAH111Z-1.1/4	7314150343386	1	40,63	475
TAH111Z-1.1/8	7314150343393	1	38,47	475
TAH111Z-1.11/16	7314150431854	1	103,73	475
TAH111Z-1.13/16	7314150431878	1	123,05	475
TAH111Z-1.3/4	7314150431861	1	120,49	475
TAH111Z-1.3/8	7314150431816	1	72,52	475
TAH111Z-1.5/16	7314150343409	1	51,56	475
TAH111Z-1.5/8	7314150431847	1	99,65	475
TAH111Z-1.7/16	7314150431823	1	72,52	475
TAH111Z-1.7/8	7314150431885	1	152,66	475
TAH111Z-1/2	7314150343461	1	20,28	475
TAH111Z-1/4	7314150343508	1	16,18	475
TAH111Z-11/16	7314150343522	1	21,67	475
TAH111Z-13/16	7314150343539	1	28,88	475
TAH111Z-15/16	7314150343546	1	30,95	475
TAH111Z-2	7314150431892	1	153,22	475
TAH111Z-2.1/4	7314150431915	1	384,85	475
TAH111Z-2.3/4	7314150431946	1	520,88	475
TAH111Z-2.3/8	7314150413959	1	384,85	475
TAH111Z-2.5/8	7314150431939	1	506,92	475
TAH111Z-2.7/8	7314150431953	1	683,85	475
TAH111Z-3	7314150431960	1	707,62	475
TAH111Z-3/4	7314150343553	1	23,20	475
TAH111Z-3/8	7314150343560	1	19,16	475
TAH111Z-5/16	7314150343591	1	16,41	475
TAH111Z-5/8	7314150343607	1	21,96	475
TAH111Z-7/16	7314150343614	1	19,77	475
TAH111Z-7/8	7314150343621	1	30,41	475
TAH111Z-9/16	7314150343638	1	20,87	475
TAH1150-1/2H/P	7314150307760	1	131,37	488
TAH1177-SCRIBE	7314150307777	1	24,29	488
TAH140	7314150344475	1	72,04	477
TAH141	7314150339433	1	78,53	477
TAH1410	7314150344543	1	88,03	477
TAH142	7314150339440	1	102,87	477
TAH1420	7314150344550	1	97,38	477
TAH143	7314150344482	1	146,74	477
TAH1544	7314150307746	1	20,55	489
TAH16-H10	7314150306176	1	17,73	479
TAH16-H12	7314150306183	1	18,15	479
TAH16-H14	7314150306190	1	19,90	479
TAH16-H17	7314150306206	1	19,08	479
TAH16-H19	7314150306213	1	19,61	479
TAH16-H4	7314150306121	1	16,37	479
TAH16-H5	7314150306138	1	16,37	479
TAH16-H6	7314150306145	1	16,37	479
TAH16-H7	7314150306152	1	16,37	479
TAH16-H8	7314150306169	1	17,73	479
TAH16-T30	7314150306220	1	18,56	479
TAH16-T40	7314150306237	1	21,67	479
TAH16-T45	7314150306244	1	21,67	479
TAH16-T50	7314150306251	1	21,67	479
TAH16-T55	7314150306268	1	27,13	479
TAH16-T60	7314150306275	1	27,13	479
TAH16B-1	7314150306077	1	13,91	478
TAH16B-1.1/16	7314150306084	1	16,75	478
TAH16B-1.1/4	7314150306107	1	16,76	478
TAH16B-1.1/8	7314150306114	1	16,75	478
TAH16B-1/2	7314150305995	1	9,32	478
TAH16B-10	7314150305629	1	8,21	478
TAH16B-11	7314150305636	1	8,21	478
TAH16B-11/16	7314150306022	1	10,79	478
TAH16B-12	7314150305643	1	8,70	478
TAH16B-13	7314150305650	1	9,08	478
TAH16B-13/16	7314150306046	1	11,91	478
TAH16B-14	7314150305667	1	9,53	478
TAH16B-15	7314150305674	1	9,90	478
TAH16B-15/16	7314150306060	1	13,91	478
TAH16B-16	7314150305698	1	10,09	478
TAH16B-17	7314150305704	1	10,48	478
TAH16B-18	7314150305711	1	10,48	478
TAH16B-19	7314150305728	1	10,91	478
TAH16B-21	7314150305735	1	11,50	478
TAH16B-22	7314150305742	1	11,91	478
TAH16B-24	7314150305759	1	13,43	478
TAH16B-25	7314150305766	1	13,63	478
TAH16B-27	7314150305773	1	14,32	478
TAH16B-3/4	7314150306039	1	11,30	478
TAH16B-30	7314150305780	1	15,93	478
TAH16B-32	7314150305797	1	16,25	478
TAH16B-5/8	7314150306015	1	10,48	478
TAH16B-7/8	7314150306053	1	12,32	478
TAH16B-8	7314150305612	1	8,89	478
TAH16B-9/16	7314150306008	1	9,93	478
TAH16BM/22	7314150422357	1	499,12	479
TAH16BZ/17	7314150422340	1	429,80	479
TAH16H-1/2	7314150306329	1	17,46	479
TAH16H-1/4	7314150306282	1	16,06	479



TAH16H-3/8	7314150306305	1	16,06	479
TAH16H-5/16	7314150306299	1	16,06	479
TAH16H-5/8	7314150306343	1	18,36	479
TAH16H-7/16	7314150306312	1	16,53	479
TAH16H-9/16	7314150306336	1	17,89	479
TAH1949M-10-11	7314150308866	1	29,80	476
TAH1949M-12-14	7314150308873	1	33,39	476
TAH1949M-14-17	7314150308880	1	33,39	476
TAH1949M-19-22	7314150308897	1	45,66	476
TAH1949M-24-27	7314150308903	1	66,03	476
TAH1949M-8-9	7314150308859	1	29,80	476
TAH1995M-10	7314150432219	1	25,07	482
TAH1995M-12	7314150432226	1	26,33	482
TAH1995M-8	7314150432202	1	24,28	482
TAH1995Z-1/2	7314150415007	1	27,97	482
TAH1RM-10	7314150414338	1	30,18	475
TAH1RM-11	7314150424306	1	31,84	475
TAH1RM-12	7314150424313	1	32,72	475
TAH1RM-13	7314150414345	1	31,87	475
TAH1RM-14	7314150424320	1	36,17	475
TAH1RM-15	7314150424337	1	37,17	475
TAH1RM-16	7314150414352	1	38,05	475
TAH1RM-17	7314150352210	1	38,05	475
TAH1RM-18	7314150414369	1	39,28	475
TAH1RM-19	7314150352227	1	41,04	475
TAH1RM-21	7314150424344	1	50,80	475
TAH1RM-22	7314150424351	1	49,16	475
TAH1RM-24	7314150352234	1	53,36	475
TAH1RM-27	7314150424368	1	80,87	475
TAH1RM-30	7314150352241	1	95,53	475
TAH1RM-32	7314150424375	1	106,00	475
TAH1RM-6	7314150424269	1	28,94	475
TAH1RM-7	7314150424276	1	28,94	475
TAH1RM-8	7314150424283	1	29,07	475
TAH1RM-9	7314150424290	1	30,08	475
TAH2047-0.8-4	7314150308088	1	27,97	482
TAH2047PR-1-2	7314150308095	1	31,48	482
TAH2101G-125	7314150344581	1	57,36	482
TAH2101G-125C	7314150344598	1	57,36	482
TAH2101G-140	7314150307869	1	52,70	482
TAH2101G-140C	7314150344611	1	60,30	482
TAH2101G-160	7314150307876	1	61,06	482
TAH2101G-160C	7314150344635	1	61,06	482
TAH2101G-180	7314150345106	1	62,69	482
TAH2101G-180C	7314150344666	1	62,69	482
TAH21HDG-200	7314150345649	1	64,02	483
TAH21HDG-200C	7314150345656	1	64,02	483
TAH2223G-150	7314150411597	1	56,58	483
TAH225-PLUS	7314150319978	1	53,76	485
TAH2339-250	7314150536320	1	39,66	484
TAH2427G-200	7314150307883	1	44,77	483
TAH2430G-160	7314150413942	1	43,10	483
TAH2430G-200	7314150307906	1	43,61	483
TAH2484-30	7314150307968	1	15,42	487
TAH2487	7314150320028	1	21,45	489
TAH24B-27	7314150309306	1	25,19	479
TAH24B-30	7314150309313	1	28,27	479
TAH24B-32	7314150309320	1	29,44	479
TAH24B-36	7314150309337	1	34,03	479
TAH24B-38	7314150309344	1	36,24	479
TAH24B-41	7314150309351	1	39,93	479
TAH24B-46	7314150309368	1	47,12	479
TAH24B-50	7314150309375	1	53,24	479
TAH2509	7314150307753	1	94,11	490
TAH2535F2	7314150307784	1	51,18	490
TAH2628G-160	7314150307913	1	56,75	483
TAH2628G-180	7314150307920	1	58,49	483
TAH2628G-200	7314150432363	1	74,65	483
TAH2633/S4	7314150415014	1	122,64	490
TAH2800-150	7314150519330	1	44,81	483
TAH2800-180	7314150424559	1	75,54	483
TAH2820EF2	7314150307708	1	27,56	485
TAH2855	7314150307937	1	205,05	484
TAH2900-180	7314150424566	1	76,17	483
TAH2951-250	7314150432400	1	62,05	484
TAH2953-140	7314150415731	1	57,40	484
TAH2953-300	7314150415748	1	73,02	484
TAH2958-200	7314150320219	1	45,94	484
TAH2958-250	7314150307944	1	49,64	484
TAH2970G-200	7314150343331	1	59,47	483
TAH29M-10	7314150414413	1	79,61	476
TAH29M-11	7314150414420	1	80,24	476
TAH29M-12	7314150424382	1	80,24	476
TAH29M-13	7314150414437	1	80,24	476
TAH29M-14	7314150424399	1	80,24	476
TAH29M-15	7314150424405	1	80,24	476
TAH29M-16	7314150424412	1	80,24	476
TAH29M-17	7314150414444	1	80,85	476
TAH29M-18	7314150424429	1	80,85	476



TAH29M-19	7314150424436	1	80,85	476
TAH29M-20	7314150424443	1	80,85	476
TAH29M-21	7314150414451	1	84,40	476
TAH29M-22	7314150424450	1	84,40	476
TAH29M-23	7314150424467	1	85,03	476
TAH29M-24	7314150424474	1	89,61	476
TAH29M-25	7314150424481	1	90,27	476
TAH29M-26	7314150424498	1	95,17	476
TAH29M-27	7314150424504	1	94,09	476
TAH29M-28	7314150424511	1	97,63	476
TAH29M-29	7314150424528	1	102,17	476
TAH29M-30	7314150424535	1	104,86	476
TAH29M-32	7314150424542	1	109,89	476
TAH29M-6	7314150414376	1	77,12	476
TAH29M-7	7314150414383	1	78,37	476
TAH29M-8	7314150414390	1	79,61	476
TAH29M-9	7314150414406	1	79,61	476
TAH2M-10-11	7314150427772	1	53,07	476
TAH2M-12-13	7314150427789	1	53,67	476
TAH2M-14-15	7314150427796	1	55,05	476
TAH2M-16-17	7314150427802	1	56,37	476
TAH2M-18-19	7314150427819	1	58,22	476
TAH2M-6-7	7314150427758	1	50,14	476
TAH2M-8-9	7314150427765	1	52,17	476
TAH317	7314150319985	1	39,28	485
TAH320	7314150319992	1	28,80	484
TAH325	7314150320004	1	73,07	484
TAH3625PU-50	7314150307579	1	62,53	486
TAH3625W-35	7314150307609	1	52,89	486
TAH3640-250-C	7314150307975	1	33,89	487
TAH3681-11	7314150415038	1	71,49	488
TAH3681-16	7314150415045	1	79,03	488
TAH3681-20	7314150415052	1	97,15	488
TAH3683	7314150352258	1	43,43	487
TAH3734BM-10	7314150308057	1	23,37	487
TAH3734BM-2	7314150343348	1	29,95	487
TAH3734BM-3	7314150307982	1	29,95	487
TAH3734BM-4	7314150308019	1	30,41	487
TAH3734BM-5	7314150308026	1	30,41	487
TAH3734BM-6	7314150308033	1	31,26	487
TAH3734BM-8	7314150308040	1	31,48	487
TAH3739-300	7314150373925	1	34,15	487
TAH3755BM-4	7314150308064	1	16,54	487
TAH380-10	7314150307845	1	71,14	477
TAH380-14	7314150320172	1	94,57	477
TAH380-18	7314150307852	1	135,06	477
TAH380-24	7314150343317	1	200,36	477
TAH396-JT	7314150373932	1	58,37	484
TAH4205H-80-160	7314150411610	1	44,82	489
TAH466-250	7314150307791	1	44,42	488
TAH479-16	7314150307586	1	62,93	486
TAH479-32	7314150307593	1	68,89	486
TAH481-300	7314150307616	1	49,86	486
TAH484-1000	7314150373918	1	62,24	486
TAH484-1500	7314150307623	1	60,26	486
TAH484-2000	7314150319916	1	63,20	486
TAH485	7314150459902	1	60,67	487
TAH486F-700	7314150370658	1	31,89	486
TAH487-5200	7314150307630	1	594,59	487
TAH489-1100	7314150307647	1	204,94	486
TAH489-1800	7314150343294	1	219,51	486
TAH489-2700	7314150319923	1	228,59	486
TAH489-3600	7314150307654	1	252,12	486
TAH489-4500	7314150427567	1	352,14	486
TAH489-5400	7314150319930	1	297,56	486
TAH490-1100	7314150427475	1	162,21	486
TAH490-700	7314150427529	1	131,77	486
TAH490-900	7314150427536	1	137,92	486
TAH52	7314150339730	1	24,68	486
TAH6950	7314150309054	1	51,20	478
TAH6956-1	7314150309061	1	15,15	478
TAH6958B-1	7314150309078	1	44,30	477
TAH6960	7314150305315	1	11,90	477
TAH6961	7314150305322	1	12,91	477
TAH6962	7314150305339	1	16,50	477
TAH6962L	7314150305346	1	37,64	477
TAH6966	7314150305353	1	29,80	477
TAH6M-10-11	7314150370665	1	16,74	476
TAH6M-12-13	7314150370672	1	17,16	476
TAH6M-14-15	7314150400393	1	17,41	476
TAH6M-16-17	7314150400409	1	17,76	476
TAH6M-17-19	7314150370689	1	20,45	476
TAH6M-18-19	7314150400416	1	20,55	476
TAH6M-20-22	7314150400423	1	25,08	476
TAH6M-24-27	7314150400430	1	43,91	476
TAH6M-30-32	7314150400447	1	50,90	476
TAH6M-6-7	7314150427741	1	13,75	476
TAH6M-8-9	7314150400386	1	14,35	476
TAH700-1.5-50	7314150432301	1	54,44	481



TAH700-1.8-50



TAH700-1.8-50	7314150432318	1	54,44	481
TAH700-2.5-50	7314150432325	1	54,92	481
TAH700-3-100	7314150432332	1	54,92	481
TAH701-0-50	7314150432349	1	54,49	481
TAH701-00-50	7314150432356	1	54,49	481
TAH703-10-50	7314150432288	1	54,60	482
TAH703-15-75	7314150432295	1	54,81	482
TAH703-6-50	7314150432240	1	54,63	482
TAH703-7-50	7314150432257	1	54,63	482
TAH703-8-50	7314150432264	1	54,63	482
TAH703-9-50	7314150432271	1	54,68	482
TAH73R-100	7314150503810	1	442,36	489
TAH73R-200	7314150503834	1	457,11	489
TAH73R-300	7314150503858	1	473,96	489
TAH7444SG-M-36	7314150308934	1	66,62	476
TAH7444SG-M-41	7314150308941	1	85,04	476
TAH7444SG-M-46	7314150308958	1	93,23	476
TAH7444SG-M-50	7314150308965	1	104,81	476
TAH7444SG-M-55	7314150308972	1	119,85	476
TAH7445-100A-1	7314150327546	1	326,82	489
TAH7452-2	7314150302543	1	120,65	489
TAH7455-300-1	7314150309412	1	397,31	489
TAH74W9-100	7314150519354	1	260,51	489
TAH782-U	7314150339747	1	23,61	486
TAH7852-1	7314150302550	1	96,31	489
TAH8069	7314150383603	1	52,65	475
TAH8069C	7314150383610	1	54,99	475
TAH8070	7314150347025	1	50,69	475
TAH8070C	7314150383627	1	39,37	475
TAH8071	7314150347032	1	54,69	475
TAH8071C	7314150383634	1	40,77	475
TAH8072	7314150307487	1	50,79	475
TAH8072C	7314150383641	1	44,70	475
TAH8073	7314150319831	1	73,78	475
TAH8073C	7314150383658	1	54,33	475
TAH8074	7314150319848	1	120,60	475
TAH8074C	7314150383665	1	90,80	475
TAH8075	7314150307500	1	189,48	475
TAH8075C	7314150383672	1	129,88	475
TAH8150-1/2	7314150309283	1	81,82	479
TAH8158B-1	7314150309290	1	106,88	478
TAH8160	7314150306367	1	81,85	478
TAH8162	7314150306374	1	100,54	478
TAH8166	7314150306381	1	41,56	478
TAH8224	7314150307951	1	73,52	484
TAH84-PODGER	7314150312221	1	52,46	475
TAH8950N/A	7314150309382	1	203,81	480
TAH8953	7314150309399	1	56,08	479
TAH8961	7314150309405	1	49,21	479
TAH9045-B-250	7314150411634	1	37,07	488
TAH9048-250	7314150411627	1	38,23	488
TAH9070	7314150307517	1	44,59	475
TAH9072	7314150307524	1	63,04	475
TAHBE-8020L	7314150308101	1	19,26	480
TAHBE-8030	7314150308118	1	19,79	480
TAHBE-8040	7314150308125	1	20,68	480
TAHBE-8040S	7314150308132	1	13,16	481
TAHBE-8050S	7314150308149	1	15,70	481
TAHBE-8155	7314150308156	1	29,96	480
TAHBE-8220S	7314150308163	1	10,85	481
TAHBE-8241	7314150308217	1	24,19	480
TAHBE-8252	7314150308224	1	28,34	480
TAHBE-8255S	7314150320226	1	20,08	481
TAHBE-8257	7314150308231	1	35,14	480
TAHBE-8258	7314150308248	1	37,50	480
TAHBE-8260	7314150308255	1	40,78	480
TAHBE-8350	7314150308262	1	21,71	480
TAHBE-8602	7314150308279	1	24,02	480
TAHBE-8610	7314150308286	1	23,71	480
TAHBE-8610S	7314150308293	1	13,96	481
TAHBE-8611	7314150308300	1	23,84	480
TAHBE-8620	7314150308316	1	27,56	480
TAHBE-8620L	7314150308323	1	31,04	480
TAHBE-8620S	7314150308330	1	18,02	481
TAHBE-8623	7314150308347	1	35,00	480
TAHBE-8624	7314150308354	1	39,99	480
TAHBE-8630	7314150308361	1	42,62	480
TAHBE-8630S	7314150320233	1	23,09	481
TAHBE-8640S	7314150320240	1	34,18	481
TAHBE-8810	7314150308378	1	25,29	481
TAHBE-8820	7314150308385	1	29,00	481
TAHBE-8820SL	7314150347827	1	21,69	481
TAHBE-8830	7314150308392	1	42,62	481
TAHBE-8880	7314150432196	1	53,59	480
TAHBE-8910	7314150343713	1	27,11	481
TAHBE-8910S	7314150343799	1	20,01	481
TAHBE-8915	7314150343744	1	28,01	481
TAHBE-8915S	7314150343805	1	25,34	481
TAHBE-8920	7314150343751	1	29,34	481



TAHBE-8920S	7314150343812	1	30,02	481
TAHBE-8925	7314150343768	1	30,68	481
TAHBE-8925S	7314150343829	1	32,02	481
TAHBE-8930	7314150343775	1	32,02	481
TAHBE-8930S	7314150343836	1	33,35	481
TAHBE-9776	7314150432233	1	48,43	482
TAHBE-9777B	7314150307685	1	39,76	482
TAHBE-9787	7314150307692	1	42,57	482
TAHBE64520	7314150307821	1	96,33	490
TAHBFRL11	7314150307739	1	77,61	490
TAHBOD5400	7314150339457	1	51,41	490
TAHBOD5450	7314150339464	1	70,94	490
TAHCRW01	7314150432370	1	151,03	483
TAHCS300	7314150411603	1	37,07	488
TAHLTS-30	7314150432387	1	81,60	488
TAHMK5	7314150411580	1	44,40	476
TAHPINRELEASER	7314150307638	1	47,98	480
TAHSC2RM-13-17	7314150339792	1	54,69	476
TAHSC2RM-15-17	7314150339785	1	66,69	476
TAHSC2RM-19-22	7314150339761	1	73,37	476
TAHSC2RM-27-30	7314150339778	1	120,05	476
TAHSCB140G	7314150308071	1	41,68	485
TAHSR300-MM	7314150415021	1	51,17	488
TAHWBB600	7314150440429	1	39,14	487
TAHWBB700	7314150440436	1	41,68	487
TAM12135	7314150215331	1	404,05	115
TAM12200	7314150215348	1	404,05	115
TAM12340	7314150215355	1	494,63	115
TAM1430	7314150215317	1	362,33	115
TAM38135	7314150215324	1	362,33	115
TAS14H007	7314150423187	1	707,85	111
TAS14H09	7314150423200	1	726,81	111
TAS14S007	7314150423194	1	707,85	111
TAS14S09	7314150423217	1	726,81	111
TASM14H007	7314150539444	1	1.091,80	111
TASM14H09	7314150539437	1	1.122,70	111
TASMB14H007	7314150489664	1	1.606,98	111
TASMB14H09	7314150489671	1	1.644,36	111
TAW12340	7314150274963	1	774,42	105
TAW1412M	7314150423156	1	916,15	105
TAW1430M	7314150422289	1	916,15	105
TAW14340	7314150340842	1	1.039,93	105
TAW24800	7314150368297	1	1.233,30	105
TAW34800	7314150285471	1	1.375,26	105
TAW38135	7314150274956	1	707,66	105
TAW38135M	7314150502295	1	909,38	105
TAW912M	7314150423163	1	809,72	105
TAW9135	7314150340859	1	939,70	105
TAW9135M	7314150502288	1	884,46	105
TAW930M	7314150422319	1	830,65	105
TAWM12340	7314150274925	1	1.201,68	104
TAWM1412M	7314150423149	1	1.052,21	104
TAWM1430M	7314150422265	1	1.064,97	104
TAWM14340	7314150340835	1	1.265,46	104
TAWM24800	7314150368280	1	1.866,87	104
TAWM34800	7314150274932	1	1.729,07	104
TAWM38135	7314150274918	1	1.222,08	104
TAWM38135M	7314150502264	1	1.264,41	104
TAWM912M	7314150423132	1	1.027,38	104
TAWM9135	7314150340828	1	1.177,76	104
TAWM9135M	7314150502271	1	1.239,50	104
TAWM930M	7314150422241	1	1.084,84	104
TAWMB14340	7314150489626	1	1.930,88	104
TAWMB24650	7314150490103	1	2.229,85	104
TAWMB24800	7314150489633	1	2.478,25	104
TAWMB9135M	7314150490110	1	1.818,76	104
TAWMB930M	7314150489640	1	1.706,65	104
TEA003	7314150422180	1	1.568,46	114
TEA010	7314150422197	1	1.568,46	114
TEA030	7314150465781	1	1.493,77	114
TEA030A	7314150522750	1	1.493,50	114
TEA065	7314150472246	1	1.476,96	115
TEA1100	7314150423170	1	1.960,56	115
TEA2100	7314150465972	1	2.444,17	115
TEA350	7314150422210	1	1.459,73	115
TJS003	7314150522477	1	289,43	114
TJS010	7314150522484	1	295,61	114
TJS030	7314150522491	1	313,12	114
TL 00-SA	7314150109579	1	38,26	656
TL 00-SA-ET	7311518279219	1	45,11	659
TL 00-SA-SL	7314150115228	5	19,11	660
TL 000-SA	7314150522934	1	30,99	656
TL 00ACF	7314150522958	1	7,90	663
TL 00B-SA	7314150109555	1	42,47	656
TL 00CFR-SA	7314150115402	1	50,18	658
TL 00D-SA	7314150109562	1	42,47	656
TL 009-SA	7314150109586	1	36,70	656
TL 1-SA	7314150109647	1	36,70	656
TL 1-SA-SL	7314150115235	5	18,36	660



TL 124-SA	7314150110018	1	31,57	662
TL 15A	7314150522972	1	53,54	656
TL 15AGW	7314150522996	1	53,46	656
TL 15AGWHM-SA	7314150523016	1	90,48	656
TL 2-SA-SL	7314150115242	5	18,76	660
TL 242ACF	7314150523030	1	7,90	663
TL 242CFR-SA	7314150523054	1	26,85	658
TL 249 ACF	7314150115174	1	15,16	663
TL 249CFR-SA	7314150115143	1	50,18	658
TL 259 ACF	7314150115167	1	15,16	663
TL 259 CFR-SA	7314150115150	1	50,18	658
TL 259ACP	7314150465590	1	106,79	663
TL 259ASV	7314150465569	1	13,03	663
TL 259CPR-SA	7314150523078	1	28,11	658
TL 259SVR-SA	7314150523092	1	42,18	658
TL 2A ACF	7314150115457	1	15,16	663
TL 2A-SA	7314150110100	1	37,50	656
TL 2A-SA-ET	7314150523115	1	34,26	659
TL 2A-SA-SL	7314150115259	5	18,76	660
TL 2ACFR-SA	7314150115419	1	50,18	658
TL 3-SA	7314150110162	1	36,70	657
TL 3-SA-ET	7311518279356	1	45,11	659
TL 3-SA-SL	7314150115266	5	18,36	660
TL 3A-SA	7314150524068	1	40,53	657
TL 3C-SA	7314150110148	1	36,70	657
TL 3C-SA-ET	7314150523139	1	34,63	659
TL 3C-SA-SL	7314150115273	5	18,36	660
TL 4-SA-SL	7314150115280	5	20,40	660
TL 475-SA	7314150110032	1	37,41	662
TL 5-SA	7314150110247	1	44,49	657
TL 5-SA-ET	7314150523153	1	38,14	659
TL 5-SA-SL	7314150115297	5	22,26	660
TL 51S-SA	7314150110209	1	41,21	657
TL 578-SA	7314150110438	1	32,84	662
TL 582-SA	7314150110452	1	32,84	662
TL 5A-SA-SL	7314150115303	5	22,26	660
TL 5ACF	7314150115464	1	15,16	663
TL 5ACP	7314150465606	1	106,79	664
TL 5ASV	7314150465576	1	106,79	663
TL 5B-SA	7314150110223	1	47,77	657
TL 5CF-SA	7314150523177	1	25,72	658
TL 5CFR-SA	7314150115426	1	50,18	658
TL 5CPR-SA	7314150523191	1	28,11	658
TL 5SVR-SA	7314150523214	1	28,11	658
TL 6-SA	7314150523238	1	40,53	657
TL 648-SA	7314150110049	1	33,53	662
TL 649-SA	7314150110063	1	33,44	662
TL 65A-SA	7314150110278	1	42,85	657
TL 7-SA	7314150110292	1	47,77	657
TL 7-SA-ET	7314150523252	1	40,03	659
TL 7-SA-SL	7314150115310	5	23,87	661
TL 7A-SA	7314150110285	1	47,77	657
TL 7A-SA-ET	7314150523283	1	40,03	659
TL 7A-SA-SL	7314150115327	5	24,07	661
TL 7ACF	7314150115471	1	15,16	664
TL 7ACP	7314150465613	1	106,79	664
TL 7ASV	7314150465583	1	106,79	664
TL 7CFR-SA	7314150115433	1	50,18	659
TL 7CPR-SA	7314150523306	1	28,11	659
TL 7SVR-SA	7314150523320	1	28,11	659
TL AA-SA-ET	7314150523344	1	27,99	659
TL AA-SA-SL	7314150115334	5	11,21	660
TL AC-SA-SL	7314150115341	5	18,40	660
TL MM-SA-SL	7314150115365	5	11,21	661
TL SM 103-SA	7314150110773	1	40,25	662
TL SM 104-SA	7314150110780	1	40,25	661
TL SM 105-SA	7314150110797	1	40,25	661
TL SM 107-SA	7314150110810	1	40,25	661
TL SM 108-SA	7314150110827	1	40,25	661
TL SM 109-SA	7314150110834	1	40,25	661
TL SM 110-SA	7314150110841	1	40,25	661
TL SM 111-SA	7314150110858	1	40,25	661
TL SM 115-SA	7314150110896	1	40,25	662
TL SM 117-SA	7314150110919	1	40,25	662
TL SM106-SA	7314150523368	1	23,71	661
TL SM116-SA	7314150523382	1	23,71	661
TL SM116-SA-ET	7314150523405	1	40,53	659
TL SS-SA	7314150109937	1	36,70	657
TL SS-SA-SL	7314150115358	5	18,36	660
TR0325M03X-50	7314150501632	5	22,55	148
TR0636M06X-65	7314150501663	5	41,96	148
TR0650M06X-80	7314150501694	5	47,14	148
TR0860M08X-110	7314150507269	5	62,06	148
TR4.530M06X-90	7314150501755	5	40,29	148
TRX 8180	7314150112272	5	56,51	654
TSS120	7314150347063	1	219,12	112
TSS600	7314150346417	1	219,12	112
W-S-1.5	7311518140816	4	20,13	601
W-S-2.0	7311518140823	4	25,65	601



W-S-2.5	7311518140830	4	31,83	601
W-T-2.0	7311518140847	4	57,94	601
WBB1000	7314150431502	4	41,55	612
WBB1200	7314150431519	4	48,08	612
WBB1500	7314150431526	4	64,08	612
WBB400	7314150315215	10	19,41	612
WBB500	7314150315222	10	20,71	612
WBB600	7314150315239	10	22,00	612
WBB700	7314150315246	6	23,94	612
WBB800	7314150340972	6	27,18	612
WBF380	7314150315253	12	20,71	612
WBMF190	7314150315260	24	10,29	612
WBMF190IP	7314150457960	15	10,62	612
WBP-3P-3FMF	7314150444335	1	67,17	612
WBP-3P-6FMF	7314150453115	1	77,00	613
WBP-3P-96F	7314150453108	1	148,09	613
WBP300	7314150315161	20	37,53	612
WBP500	7314150315178	12	41,41	612
WBP625	7314150315185	12	54,36	612
WBP710	7314150315192	10	60,82	612
WBP900	7314150315208	6	89,30	612
WC-HOL	7314150333158	1	4,13	573
WPH 2-50	7314150520428	1	136,99	609
WPH 3-20	8412814125435	1	33,29	609
WPH 3-30	8412814125442	1	44,71	609
WR1	7314150167425	50	4,66	543
WR1-MM	7314150220069	50	4,67	543
WR2	7314150167432	25	6,21	543
WR2-12	7314150185627	25	6,21	543
WR2-MM	7314150220038	25	7,48	543
XLARGE	7314150437412	1	6.863,17	375
XXL	7314150504152	1	7.956,75	374
ZHVIDEOBAT	8414909180244	1	69,95	360
ZHVIDEOCHA	8414909180237	1	28,56	360



Preço da soldadura

Bi-metálica e Carbide

		Largura da fita de serra							
		≤ 20 mm €	27 mm €	34 mm €	41 mm €	54 mm €	67 mm €	80 mm €	100 mm €
Bi-metálica	3851 SANDFLEX® Cobra	6,70	7,47	8,55	8,55	17,82	21,12	21,12	*
	3851 SANDFLEX® Cobra PSG	*	7,47	8,55	8,55	17,82	*	*	*
	3853 SANDFLEX® Top Fabricator™	6,70	7,47	8,55	8,55	17,82	21,12	*	*
	3854 SANDFLEX® King Cobra PHG	*	7,47	8,55	8,55	17,82	21,12	21,12	*
	3857 SANDFLEX® Easy-Cut	6,70	7,47	8,55	*	*	*	*	*
	3858 PHX	*	*	8,55	8,55	17,82	21,12	21,12	*
Carbide	3860 Unset carbide	*	7,47	8,55	8,55	17,82	21,12	21,12	21,12
	3868 Carbide Triple Set® "Xtra"™	*	7,47	8,55	8,55	17,82	21,12	21,12	*
	3869 Carbide Triple Set®	6,70	7,47	8,55	*	*	*	*	*
	3881 Carbide Triple High Quad	*	*	8,55	8,55	17,82	21,12	21,12	21,12

Condições gerais de venda

12.1.1 GERAL

1.1 CONSTRUÇÃO LEGAL

A Lei adequada e em vigor do presente contrato é a lei da República Portuguesa. Para julgamento dos casos em litígio é competente o foro da comarca Vila do Conde, com expressa exclusão de qualquer outro.

1.2 INTERPRETAÇÃO DOS TERMOS COMERCIAIS

Os termos de comércio usadas nas ofertas, pedidos e confirmações de pedidos, ou utilizados no contrato serão interpretados em conformidade com a Câmara de Comércio Internacional (Incoterms) que estavam em vigor na data do contrato foi celebrado, exceto se tais regras estiverem em conflito com estas condições de venda.

1.3 APLICAÇÃO DAS CONDIÇÕES DE VENDA

1.3.1 Quando SNA Europe [Industries] S.A. (doravante denominada "Empresa") tem apresentado uma proposta de fornecimento e tal proposta deve ser considerada pelo cliente como aceitação destas condições e de quaisquer outros termos e condições contidos ou referidos na proposta. Não poderá haver rejeição ou alteração dessas condições, contidos em qualquer documento do cliente, e tal nunca terá qualquer efeito a menos que aceite estas sejam aceites por escrito pela empresa.

1.3.2 Caso a empresa distribua produtos em relação a uma ordem recebida pelo seu cliente, considera-se ser aceite pela Companhia em apenas os termos destas condições e não outros.

2. OFERTAS E ACEITAÇÃO

2.1 Validação

Salvo disposição em contrário ou previamente retiradas todas as propostas feitas pela empresa, estas serão válidas durante o período de 30 dias a contar da data em que for apresentado, tal data a ser considerada a data de envio pela Empresa ou da data que figura no documento, o que ocorrer primeiro.

2.2 Aceitação

A aceitação da proposta ou qualquer proposta feita pela empresa deve ser por escrito, e acompanhadas de suficiente informações que permitam à empresa prosseguir com a ordem imediatamente, depois do qual a empresa possui liberdade para aumentar os preços das propostas.

3. PROPRIEDADE E RISCO

3.1 No caso de pedidos de envio para destinos dentro de Portugal - O risco dos bens passam para o cliente no momento da entrega nas especificações do endereço enviado pelo cliente, mas a propriedade das mercadorias não passam para o cliente até o valor total do custo das mesmas foi recebido pela Empresa. Todos os seguros de bens e de terceiros são risco do cliente após a entrega das mercadorias.

3.2 No caso de pedidos de envio para destinos fora de Portugal a propriedade e o risco da mercadoria deve passar de acordo com os termos do contrato. 3.3 Além de quaisquer ónus para o qual ele pode ser legal ou tenha direito. A Empresa, deverá, em caso de insolvência do cliente ter direito a um privilégio geral sobre todos os bens da companhia em poder do cliente (apesar de tais bens ou alguns deles podem ter sido paga) para o preço não remunerada de quaisquer outros bens vendidos e entregue ao cliente pela empresa ao abrigo de qualquer contrato.

4. TEMPO DE ENTREGA

4.1 Quando o prazo de entrega é especificado, esse prazo deve ser contado a partir da data de recepção da Ordem, mas ao mesmo tempo todos os esforços feitos para efetuar a entrega nessa data e hora não deve ser da essência da contrato e a empresa não deverá, em nenhuma circunstância, ter qualquer responsabilidade a respeito de qualquer atraso na entrega e da forma como forem causados.

4.2 Em caso de venda para entrega durante um determinado período de tempo, a entrega pode ser em parcelas, com critério e conveniência da empresa, mas qualquer atraso na entrega durante o período de tempo acordado não deve ser da essência do contrato e a Empresa não deverá, em nenhuma circunstância, ter qualquer tipo de responsabilidade em relação a qualquer atraso na entrega, no entanto ocasionados.

4.3 Se o cliente não cumprir as suas obrigações ou qualquer um deles no momento adequado no que diz respeito ao fornecimento de todos os elementos necessários, como os pagamentos de licenças de importação prévias e/ou cartas de crédito, ou se a ordem for alterada, ou de qualquer forma variada por ele, ou se qualquer outra forma que ele causa ou contribui para a demora na conclusão do despacho, a Empresa poderá adiar o prazo de entrega na medida em que esta é afetada por qualquer das causas acima referidas.

Em caso de atraso superior a um mês em razão de qualquer falta de resgate por parte do cliente, a Empresa terá o direito, no todo ou em parte, para rescindir o contrato, mas com o direito de ressarcimento de danos em relação de qualquer perda (incluindo a perda de lucros) que ela pode sofrer como resultado dos mesmos.

5. ESPECIFICAÇÃO

5.1 A Empresa terá o direito de entregar mais ou menos até e incluindo 10% menos, salvo caso contrário existirem especificações do cliente e estas aceites pela empresa por escrito.

5.2 Exceto quando o cliente especifica no seu despacho eventuais tolerâncias específicas sobre as dimensões ou comprimentos ou peso e fornece todos os detalhes necessários e suficientes para tal especificação (ou se a especificação do cliente é apenas parcialmente completo em qualquer aspecto) Os bens serão fornecidos em conformidade com a fabricação das normas da Empresa e será de qualidade comercial comum. Detalhes das normas da Empresa de produção actual estão disponíveis mediante solicitação. A Empresa é o único juiz da adequação ou não dos detalhes fornecidos pelo cliente.

5.3 Caso não haja estipulações de qualidade para o cliente, a ordem será considerada como normal e exigir nenhuma qualidade mais do que comercial ordinário ou o padrão de qualidade pedido que é habitual para o tipo de bens.

5.4 Os pesos, dimensões, capacidades, avaliação de desempenho e outros dados incluídos nos catálogos da empresa, listas de prospectos, circulares, anúncios, ilustrações constituem uma aproximação. Nenhum dos ditos factos ou assuntos de forma alguma, devem ser considerados ou constituir qualquer parte da condição ou garantia, salvo na medida em que são expressamente incorporadas como tal no contrato.

5.5 Todos os desenhos dos documentos técnicos apresentados ao cliente, anterior ou posterior à formação do contrato permanecem propriedade exclusiva da Empresa. Eles não podem ser utilizados pelo cliente, ou copiados, reproduzidos, transmitidos ou comunicados a terceiros, sem consentimento escrito da Empresa.

6. TRANSPORTE E EMBALAGEM

Salvo a pedido expresso por escrito do cliente, a Empresa não será responsável para realizar a cobertura dos bens com lonas de transporte em veículos cobertos com desacoplamento proibido ou coisa parecida. Se contudo, a empresa sem consultar o cliente considera que se deve tomar tais medidas, a fim de evitar riscos de danos em trânsito, a Empresa terá o direito de cobrar a partir do custo primário de qualquer despesas extras decorrentes de tais medidas. O direito de cobrar como se aplica, se as medidas são tomadas a pedido do cliente.

7. ACEITAÇÃO DE MERCADORIAS

7.1 Sempre que expressamente acordado no contrato o cliente tem direito a inspecionar a qualidade dos materiais a mercadorias tanto durante a fabricação e quando terminadas.

Essas inspeções e verificações devem ser realizadas no local de fabrico e durante as horas normais de trabalho após o acordo por escrito com a empresa.

7.2 Se, como resultado de tal inspeção e verificação do cliente existir a opinião de que quaisquer materiais ou peças estão com defeito ou em não conformidade com o contrato, deverá, por escrito, expressar a oposição e a sua razão no prazo de um período de sete dias de qualquer controlo ou verificação.

7.3 Os produtos entregues e que não tenham sido previamente examinados pelo cliente deve ser considerada como tendo sido aceite pelo cliente, quando, após o decurso de um prazo razoável, ele não notifica a Empresa por escrito que quer para rejeitá-los. Quando o cliente deseja rejeitar bens, antes de devolver o mesmo para a Companhia, o cliente deve permitir à empresa tempo razoável e condições razoáveis para examinar os mesmos nas instalações do cliente. Se, após essa análise a Empresa concordar que o cliente tem o direito de rejeitar, as mercadorias serão devolvidas intactas para a Empresa no prazo de 14 dias. Bens devolvidos pelo cliente, sem o acordo da empresa não serão aceites pela empresa e deve ser sob o risco exclusivo do cliente em todos os momentos. O cliente deve tomar todas as precauções razoáveis para evitar danos às mercadorias a partir da data de entrega ao momento em que são recebidos de volta nas instalações da Empresa. O cliente somente terá direito de rejeitar bens, se após o exame eles estiverem com defeito de fabricação, no design ou na qualidade dos materiais utilizados, ou não conformes com a especificação do cliente.

8. ARMAZENAMENTO

Se a empresa não receber instruções de envio adequado para permitir a expedição da mercadoria, o cliente deve ser considerado como tendo aceite o fornecimento, o mais tardar 14 dias após a notificação, e após ser avisado da inadequação por escrito da Empresa, a responsabilidade exclusiva para o armazenamento desta mercadoria deve recair sobre o cliente e os bens devem, posteriormente, ser vendidos sob responsabilidade do cliente. Se a seu critério a empresa está preparada para fornecer instalações para armazenagem como beneficiário do cliente, o armazenamento deve ser sob risco do cliente e com custo extra, talvez previamente acordado por escrito, ou na falta de acordo taxas que podem ser razoavelmente decididas pela Empresa. A Empresa é o único juiz na adequação ou não da totalidade ou de tais instruções de encaminhamento da mercadoria.

9. PREÇOS

9.1 Todos os preços são baseados nas taxas actuais da empresa e custos de materiais e equipamentos de trabalho. Embora todos os os esforços serão feitos para respeitar essas taxas e custos, pedidos só são aceites no pressuposto de que esses preços serão sujeitos a variações de modo a incluir qualquer aumento dos custos que entrem em vigor antes da entrega das mercadorias, e o preço devem portanto ser aqueles em vigor na data de expedição.

9.2 Em caso de suspensão dos trabalhos por instruções do cliente ou de o cliente não ter dado instruções adequadas para a Empresa do preço da mercadoria, esta pode ser aumentada para cobrir todas as despesas extra incorridas. A adequação ou não de instruções será determinada única e exclusivamente pela Empresa bem como o montante de todos esses aumentos no preço.

9.3 Quando for necessário a Empresa importar produtos ou componentes para seus produtos, os preços colados são com base na taxa de direitos de importação e taxas em vigor na data de qualquer colação. Em caso de qualquer alteração na taxa de qualquer imposto ou taxa de importação ou qualquer imposição de qualquer medida fiscal nova entre a data da colação e a data de entrega da mercadoria, os preços serão aumentados de forma a incluir os custos adicionais de importação de os produtos ou componentes.

9.4 Todos os preços indicados são sem impostos e, portanto, sujeita à adição de valor acrescentado e/ou qualquer forma de imposto actualmente em vigor que se aplica às mercadorias em causa, salvo acordo escrito entre a Empresa e o cliente.

10. TERMOS DE PAGAMENTO

10.1 CONTA CORRENTE CLIENTE

A Empresa terá o direito de cobrar juros mensais em contas vencidas por cada mês ou meses, quando parte do pagamento está atrasado. Um cliente torna-se vencido no final do último dia do mês seguinte ao mês da data da factura. A taxa de juros será de um duodécimo da percentagem por ano, que é cinco por cento maior que a taxa de base para empréstimos do Banco BVVA em vigor no primeiro dia de cada mês. O direito da Empresa em cobrar juros sobre contas em atraso devem em nada prejudicar o direito de recuperar o dinheiro (inclusive juros vencidos devidos) por um processo legal no momento em que a Empresa possa pensar. A Empresa nunca ficará sob nenhuma obrigação de permitir que as contas em atraso continuem no pagamento de juros. Esse Juro todas as contas pendentes deve ser composto de mês a mês até o pagamento de todo o montante em dívida.

10.2 Se o cliente falhar ou se recusar a aceitar as mercadorias, quando notificado de que estas sejam prontas para entrega, o momento em que as mercadorias estejam prontas é considerada como a data de entrega e o pagamento será feito conformidade salvo acordo em contrário por escrito e aceite pela Empresa.

10.3 Se antes da entrega ser efetuada surgirem motivos razoáveis para supor que o cliente não será capaz de cumprir as obrigações de pagamento, a Empresa terá o direito de exigir o pagamento antecipado ou caução. Se a caução não for aceitável pela Empresa esta poderá rescindir o contrato sem responsabilidade da sua parte, mas o comprador deve pagar à Empresa em relação a eventuais prejuízos (incluindo perda de lucro) incorridas pela Empresa em decorrência da rescisão. Aceitabilidade de segurança deve ser determinada por critério exclusivo da Empresa.

10.4 A existência de um diferendo ou dúvida relativa a apenas parte de qualquer factura não isentará o cliente da sua obrigação para fazer o pagamento em relação à parte de qualquer factura que não é o assunto. O mesmo se aplica à parte de qualquer factura em relação aos quais haja nenhuma disputa ou consulta.

10.5 Caso o cliente deixe de pagar dentro dos prazos estabelecidos na cláusula 10, ou nos termos de um contrato acordado entre ele e a Empresa, o cliente deve perder todos os benefícios de qualquer desconto previamente acordado.

11. CANCELAMENTO

11.1 Cancelamento de Ordens pelo cliente não pode existir, exceto mediante os termos que indemnizam a Empresa contra todas as perdas. Bens devolvidos sem o consentimento da Empresa por escrito não serão aceites para o crédito e permanecem sob o risco exclusivo e de responsabilidade exclusiva do cliente.

11.2 O cancelamento de encomendas pela Empresa pode surgir em qualquer circunstância que esteja além do controle da Empresa e pelo qual sem qualquer culpa da sua conclusão, parte da entrega está impedida ou retardada, a Empresa deverá ser isenta de toda responsabilidade e reserva-se o direito de por sua própria opção adiar a entrega por esse período, além do prazo de entrega estabelecido no contrato, e que seja adequado às circunstâncias, cancelar total ou parcialmente a cancelar. A título de ilustração, a seguir estão as circunstâncias que podem dar origem ao direito da companhia de adiar a entrega, total ou parcialmente, ou de cancelar o contrato; A saber: o trabalho disputas chamando até de pessoal para o serviço militar e quaisquer outras dificuldades na obtenção de recursos humanos, o bloqueio no caso de guerra, político ou outros distúrbios civis, quaisquer actos direcção decretos ou proibições ou pelo Governo central ou seus agentes, tais como confiscação ou proibições de exportação e importação, bem como a recusa de licenças, e outros eventos naturais tais como escassez de energia, danos nas máquina ou outros deslocamentos de fabrico, falta de transporte ou distúrbios tráfego em ferrovias, portos ou outras agências de transporte, o atraso dos navios ou outros meios de transporte durante o fabrico que não poderiam razoavelmente ter sido previstas a não-entrega, defeitos ou adiadas entregas por fornecedores da empresa ou de seus fornecedores de peças de sub-empreiteiros e semi-manufaturados produtos, matérias-primas, condições de alimentação de qualquer outra espécie que estão além do controle da Empresa que afetam a sua responsabilidade para cumprimento do contrato. A Empresa pode, no entanto, sem demoras desnecessárias e o mais tardar, 30 dias após tomar conhecimento da ocorrência e notificar o cliente e o contrato permanece válido e se assim for a data aproximada em que espera-se que a entrega pode ser feita ou em saber se o contrato foi cancelado, no todo ou em parte, cancelada a medida em que foi anulado. Se o cliente razoavelmente considerar que não pode aceitar a data de entrega que indicou, o cliente pode imediatamente cancelar o contrato, desde que a fabricação das mercadorias não tenha já chegado a tal estágio que a Empresa entende que não pode usar o material para qualquer fim.

12. QUEBRA DE DIREITOS DE TERCEIRAS PARTES

12.1 Garantias do cliente

12.1.1 Que o modelo de qualquer design, especificação, desenho ou e instrução dada pelo cliente para a Empresa não infringe qualquer patentes, marcas registradas de design ou de direitos autorais na execução do contrato ou das disposições dos acordos em que o cliente é uma parte.

12.1.2 Que as mercadorias fornecidas pela empresa não serão utilizadas de uma forma ou para qualquer propósito ou mesmo em combinação com quaisquer outros bens e materiais de forma a constituir uma violação de todas as cartas, patente, desenho ou modelo registado, marca e de direitos autorais ou das disposições de qualquer acordo para que o cliente é uma parte.

12.2 O cliente deverá indenizar a Empresa contra qualquer pedido de indemnização ao abrigo da lei.

12.1.1 e 12.1.2 acima e contra todos os custos e prejuízos incorridos em relação a qualquer queixa e para a qual a Empresa pode tornar-se responsável.

13. GARANTIAS

13.1 Como a seguir indicado a Empresa compromete-se a sanar um defeito resultante de concepção de materiais com defeito e fabricação dos bens que podem se manifestar no prazo de 12 meses após a entrega, desde sempre que o cliente notifique imediatamente a empresa e especifique por escrito, no prazo de três dias úteis do evento da natureza precisa e a extensão do defeito. Em nenhuma circunstância a esta garantia se aplica em relação a qualquer notificação feita depois de 12 meses a contar da data de entrega.

13.2 Os direitos do cliente de acordo com esta cláusula 13 são condicionais desde que concedam o direito de a Empresa possuir razoável oportunidade e tempo para realizar todo o trabalho necessário para remediar e reparar a situação.

13.3 Após a recepção da notificação, a empresa deve tomar todas as medidas razoáveis para corrigir o defeito no prazo de um prazo razoável, e corrigir a natureza do defeito mesmo que para tal efetuar as reparações no local, o cliente devolverá à Empresa qualquer parte com defeito coberto por esta cláusula que tenha aparecido para reparo ou substituição pela Empresa e, nesse caso, a entrega no cliente de tal peça, devidamente reparada ou uma peça em substituição deve ser considerada pela Empresa como suas obrigações nos termos desta cláusula.

13.4 As peças defeituosas substituídas, de acordo com esta cláusula deve ser colocado à disposição da Empresa.

13.5 A empresa não se responsabiliza por defeitos decorrentes de materiais ou de projetos ou especificações estipulado pelo cliente.

13.6 A responsabilidade da empresa só é aplicável em relação aos defeitos que aparecem quando as mercadorias tenham sido utilizadas em estrita conformidade com as condições de operação (se houver), previsto no contrato e em qualquer caso, apenas quando o uso tem sido razoável e justo. Em particular, mas sem prejuízo da generalidade do exposto, são defeitos decorrentes do funcionamento defeituoso do cliente ou de manutenção e de alterações realizadas sem a Consentimento da Empresa por escrito e de reparações efectuadas indevidamente pelo Comprador nunca podem cair dentro da garantia nem sobre a deterioração devido ao desgaste normal.

14. LIMITE DE DANOS

14.1 Quando uma das partes é responsável por danos a outros, estes não devem exceder o dano que a parte padrão poderia razoavelmente ter previsto no momento da formação do contrato.

14.2 A parte que estabelece uma violação do contrato deve ter o dever tomar todas as medidas necessárias para atenuar as perdas que ocorreram desde que possa fazê-lo sem inconveniência e custo razoável. Se ele não conseguir fazer isso, então o partido culpado da violação pode pedir uma redução nos danos.

14.3 A empresa deverá, em nenhuma circunstância, ser responsável pelos prejuízos ou danos que sejam causados em que o mesmo seja previsível pela Empresa e for considerado que a perda económica (o que significa perda de lucro, negócio, receitas, economias antecipadas, encargos de empréstimos e qualquer interesse de qualquer natureza) ou por qualquer perda indirecta e outros especiais ou danos (com excepção dos custos adicionais na verdade, razoável e necessariamente suportados pelo cliente como um resultado directo de qualquer incumprimento por parte da Empresa), nem por quaisquer reclamações ou qualquer parte de quaisquer reclamações feitas contra o cliente por qualquer outra entidade, nem todas as despesas e custos e quaisquer outras despesas daí decorrentes.

15. CANCELAMENTO DO CONTRACTO

Rescisão do contrato por qualquer motivo, serão decorrentes sem prejuízo dos direitos das partes adquiridos ao abrigo do contrato no momento da rescisão.

16. ENCOMENDA DE VALOR MÍNIMO

Uma custo de 26 € será aplicado a todas as ordens abaixo dos 200 €.

17. DEVOLUÇÕES

Não serão aceites devoluções sem aprovação prévia por escrito da SNA Europa [Industries] S.A. No caso de devoluções devido a erro do cliente será deduzido 20% do crédito do seu valor total pago pelo cliente.

18. ESTA LISTA DE PREÇOS CANCELA TODAS AS OUTRAS E ESTÁ SUJEITA A ALTERAÇÕES.



Contato

Argentina

A.M. de Justo 1750 3° A
C1107AFJ - Capital Federal
Buenos Aires
Tel: +54 (11) 4313-1004
Fax: +54 (11) 4893-3553

Australia

3 Cooper Street, Smithfield,
NSW 2164
Tel: +61 (0) 2 8787 5700
Fax: +61 (0) 2 9756 6130

Беларусь

ЗАО "Эс-Эн-Эй Европа Индастриз Бисов"
220075 СЭЗ "Минск"
ул. Селицкого, д. 8А
Телефон +375 (17) 389 79 50
info.by@snaeurope.com

Belgium

Branch of SNA Europe (Benelux) BV
De Kleetlaan 12A Pegasus Park
1831 DIEGEM
Tel: +32 (0)2 726 03 03
info.be@bahco.com

Chile

Av. Americo Vesputio 2760-D
Conchali - Santiago - Chile
Tel: + 56 2 623 0203
Fax: + 56 2 623 5395

Česká republika

SNA Europe s.r.o.
Holadnská 2/4
639 00 Brno
Tel: +420 537 022 520
Fax: +420 537 022 200

Danmark

Vallensbækvej 40,
2605 Brøndby
Tel: +45 4363 0330
Fax: +45 4396 2456

Deutschland

Willetstraße 10
40822 Mettmann
Tel: +49 (0) 2104 833 83 0
Fax: +49 (0) 2104 833 83 7999

España

c/ Hilanderas, 1
(P.O. Box / Ardo de Correos nº 5)
C.P. 20303 Irún
Tel: +34 902 235 100 / +34 943 649 111
Fax: +34 943 649 120

Ελλάδα

Λ. Βουλιαγμένης 604Γ
167 77 Ελληνικό, Αθήνα
Τηλ: +30 210 9914263
Fax: +30 210 9914587

Export

Antigua Carretera de Altube Km 5,5
P.O.Box 307
01080 VITORIA (Spain)
Tel: +34 945269711
Fax: +34 945165040

France

ZAC de l'Hoirie
20 rue Charles Lacretelle
CS 60101
49072 Beaucouzé cedex
Tél: +33 (0) 2 41 22 98 40
Fax: +33 (0) 2 41 22 98 50

Italia

SNA EUROPE Italia S.p.A.
Via Georges Bizet, 13/15
20092 Cinisello Balsamo MI - Italia
Tel. +39 02 3024161
info.it@snaeurope.com

Казахстан

050000, Алматы,
ул.Шевченко 1656/72г, оф.217
Тел/факс +7 727323 63 39

Nederland

Vossenbeemd 113
5705 CL Helmond
Tel: +31 (0) 492 58 23 82
info.nl@bahco.com

New Zealand

Unit 3/25 Highbrook Drive
East Tamaki
Auckland
Tel: +64 9-273 46 50
Fax: +64-9-273-2453

Norge

Box 800
1306 Sandvika
Tel: +47 40 49 66 00

Österreich

Vienna, Nineteen, Mooslackengasse 17
A - 1190 Wien
Tel: +49 (0) 2104 8 33 83 0
Fax +49 (0) 2104 833 83 79 99

Polska

ul. Marynarska 15
02-674 Warszawa
Tel.: +48 (0) 22 6070510
Fax: +48 (0) 22 6070521

Россия

ООО "Эс-Эн-Эй Юроп (РУС)"
141407 г. Химки
ул. Панфилова вл.21, стр.1
Телефон +7 (495) 221 58 51
info.ru@snaeurope.com

Portugal

SNA Europe [Industries] LDA
R. Maria Julia M. Ramos - Junqueira
4480-254 Vila Do Conde
Tel. +351 252 650 131
Fax. +351 252 650 160

Slovenská republika

SNA Europe s.r.o.
Karadžičova 8/A
821 08 Bratislava
Tel: +421 (0)2 5939 6124
Fax: +421 (0)2 5939 6217

SRBIJA

Vermax-alati doo
Ul. Drage Spasić 35
11000 Beograd
Tel: +381 11 2360 500
Tel: +381 11 2360 900
Fax: +381 11 2361 147
e-mail: office@vermax.rs

Suomi

SNA Europe Oy
PL 6580
00002 Helsinki
Finland
Tel: +358 207 433 510
Fax: +358 207 433 525

Sverige

SNA Europe Industries AB
Box 83
SE-745 22 Enköping
Tel: +46 (0) 171-47 82 00
Fax: +46 (0) 171-47 82 38

Schweiz / Suisse

Willetstraße 10
40822 Mettmann
Tel: +49 (0) 2104 833 83 0
Fax: +49 (0) 2104 833 83 7999

Türkiye

Girne Mah. Maltepe Küçük San. Sitesi
F Blok No:19 Maltepe
Istanbul
Tel: +90 (0) 216 367 10 21
Fax: +90 (0) 216 367 11 71

Украина

«Бахко Бисов Свенска Акциеболаг»
SNA Europe [Ukraine & Moldova]
Телефон +38 067 441 16 09
офис 555, улица Армянская, 6А
Киев, Украина

United Kingdom

Moorhead Way, Bramley,
Rotherham, South Yorkshire S66 1YY
Tel: +44 (0) 1709 731731
Fax: +44 (0) 1709 731741

Garantia

Para informações sobre garantia, consulte o seu site local www.bahco.com



Este catálogo compreende a nossa actual gama de produtos.
Mudanças na gama, bem como mudança de formas, desenhos e designações são efectuadas continuamente.
Não serão necessariamente emitidas informações para o efeito.

Ilustrações e desenhos foram reproduzidas para serem tão precisos quanto possível. Para efeitos de um catálogo podem no entanto, diferirem dos produtos em si, bem como as especificações técnicas.

Indicações de peso devem ser entendidas como aproximados aos pesos líquidos, e servem principalmente para facilitar os cálculos das tarifas de frete e envio.

Este catálogo substitui todas as especificações e gamas de produtos anteriores.

A propriedade intelectual deste catálogo é da SNA Europe.
Excertos, reimpressões e cópias do conteúdo podem ser efectuadas com a nossa permissão.

2024





www.bahco.com

M-280-PRI-24



7 314150 546787

Preços valido só em Portugal